



50°
1964-2014
anniversario

Le creazioni

LE DECORAZIONI PER LE MIGLIORI OPERE



EDIZIONE GENNAIO 2015

Dal 1964 la Ar-fer arte ferro srl REALIZZA PER VOI decorazioni in ferro su misura per CREARE inferriate, ringhiere, recinzioni e cancellate.

I modelli che troverete in questo catalogo sono il frutto di un intenso studio, volto a creare nuovi stili ornamentali attraverso innovative tecniche produttive.

Tutto questo per poter soddisfare le molteplici esigenze architettoniche delle abitazioni moderne e non.

Abbellire Arredare ed Accogliere le tre "A" che hanno ispirato queste nuove proposte decorative per la Vostra casa.

Rendere piacevole l'arrivo nella propria dimora, soggiornarvi con serenità e ricevere le visite di persone care sono momenti preziosi nella nostra vita che si realizzano anche attraverso l'equilibrio delle forme.

Ecco perché con queste nuove proposte abbiamo pensato a come rendere ancor più vive queste occasioni.

Non più barriere, ma decorazioni che concretizzano i Vostri desideri.

Nuove manifestazioni del pensiero in armonia con l'ambiente che Vi circonda, perché la libertà d'espressione sia contribuito ad un mondo più bello.

Condividere il proprio gusto attraverso le forme e rendere visibili i confini di quanto si è conquistato nella vita, anche questo abbiamo voluto proporVi con "LE CREAZIONI".

Buona Visione!

Le Creazioni

50°
1964 - 2014
anniversario



Ar-Fer arte ferro srl

*Iron
uno*

LE DECORAZIONI
PER LE MIGLIORI OPERE
IN FERRO
PER RINGHIERE

INDICE

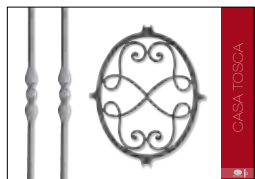

03 | CASA TOSCA

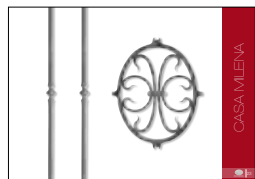

23 | CASA MILENA



43 | CASA MARISA



59 | CASA VALERIA

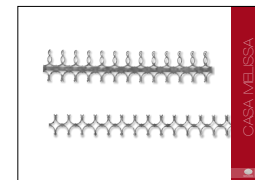

79 | CASA MELISSA

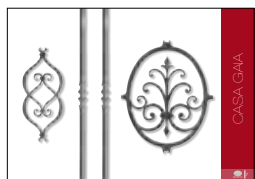

07 | CASA GAIA

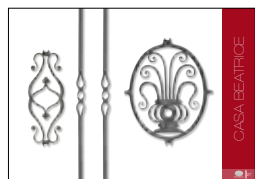

27 | CASA BEATRICE

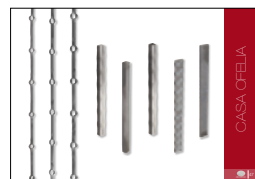

47 | CASA OFELIA

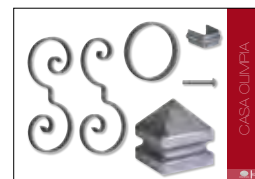

63 | CASA OLIMPIA

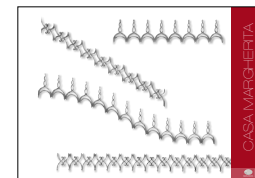

81 | CASA MARGHERITA

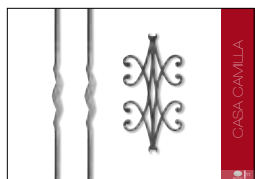

11 | CASA CAMILLA

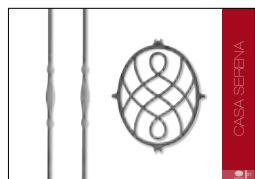

31 | CASA SERENA

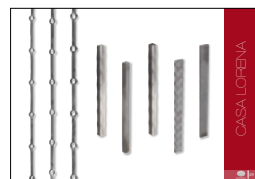

49 | CASA LORENA



67 | CASA DELIA

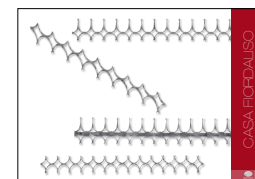

85 | CASA FIORDALISO

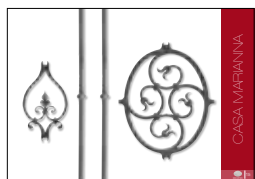

15 | CASA MARIANNA



35 | CASA GISELLA



51 | CASA MATILDE

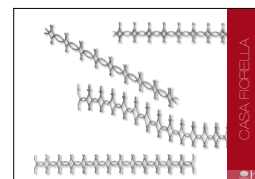

71 | CASA FIORELLA



89 | REALIZZAZIONI

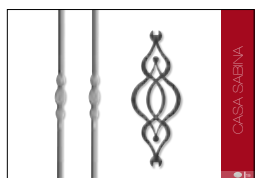

19 | CASA SABINA

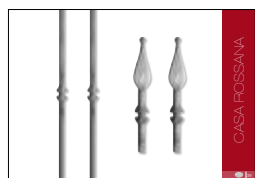

39 | CASA ROSSANA



55 | CASA ELENA

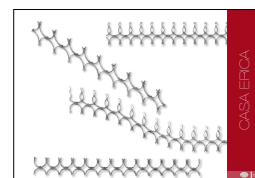

75 | CASA ERICA

Questo catalogo annulla e
sostituisce i precedenti.
Per l'ordinazione di tutti gli articoli
di questo catalogo, fare riferimento
all'"ALMANACCO" Ar Fer.

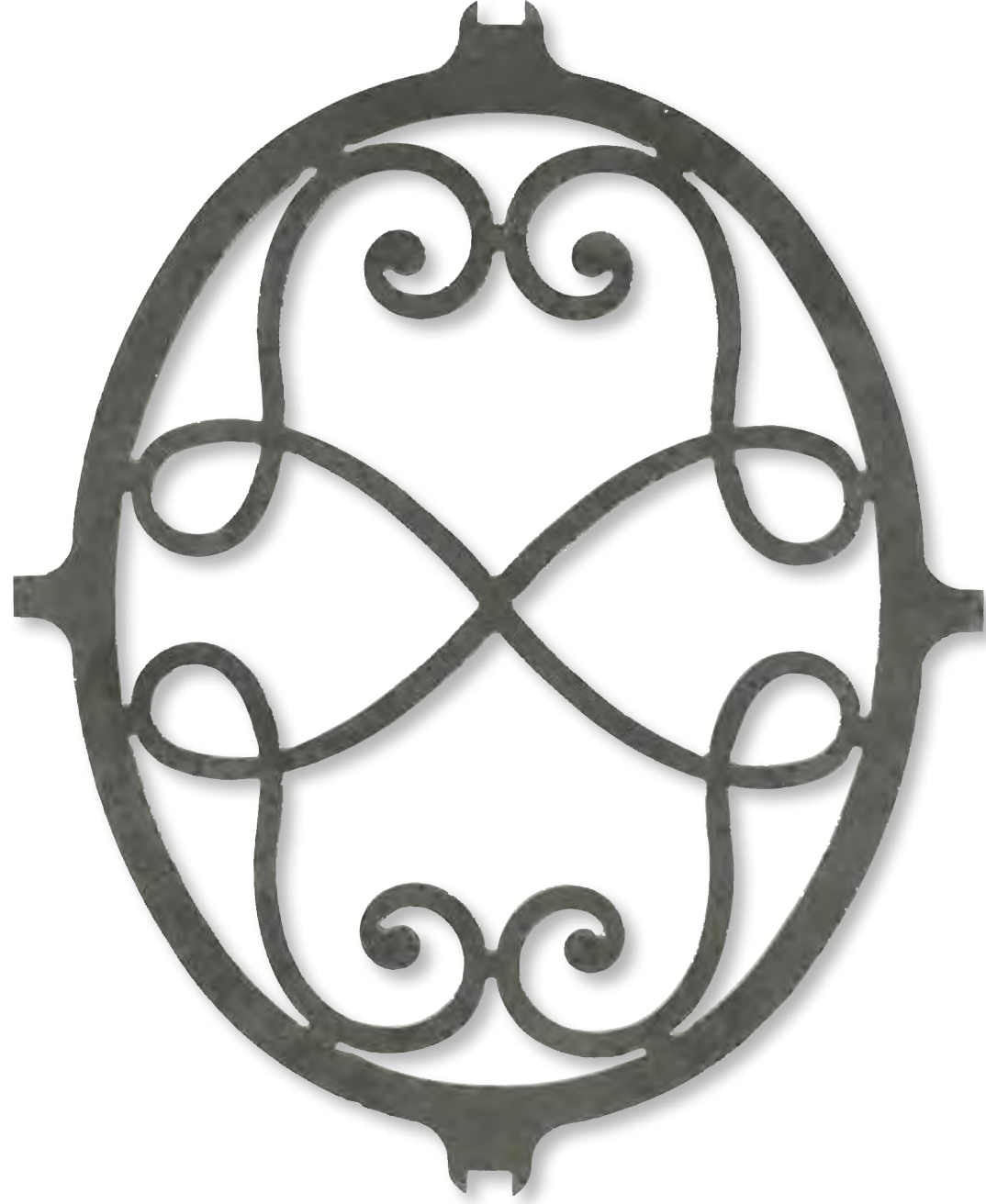
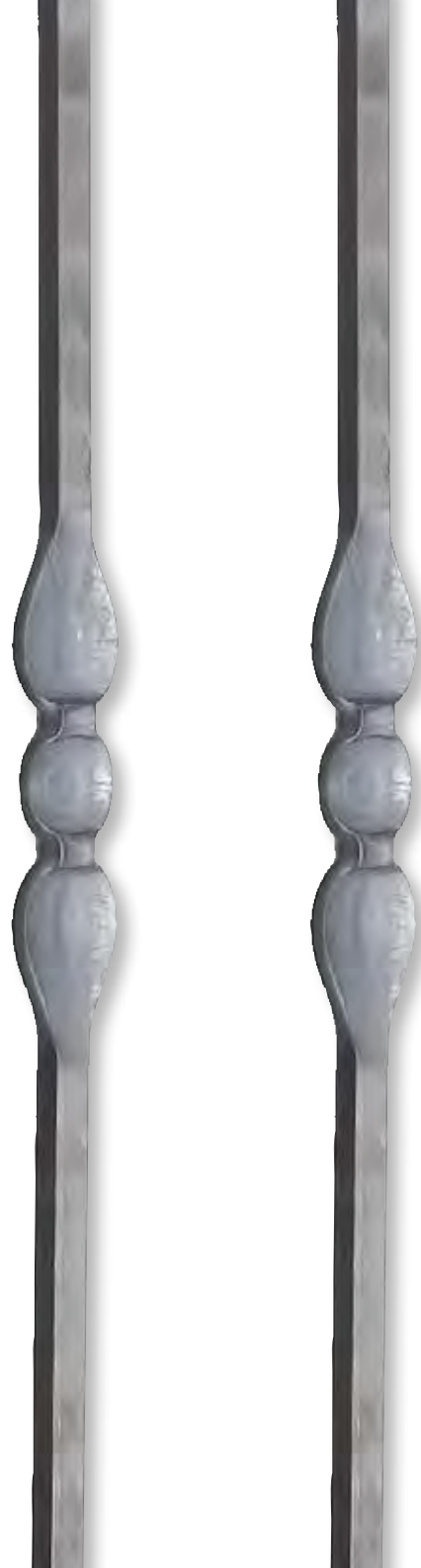

CASA TOSCA



MARCHIO REGISTRATO
RIPRODUZIONE VIETATA

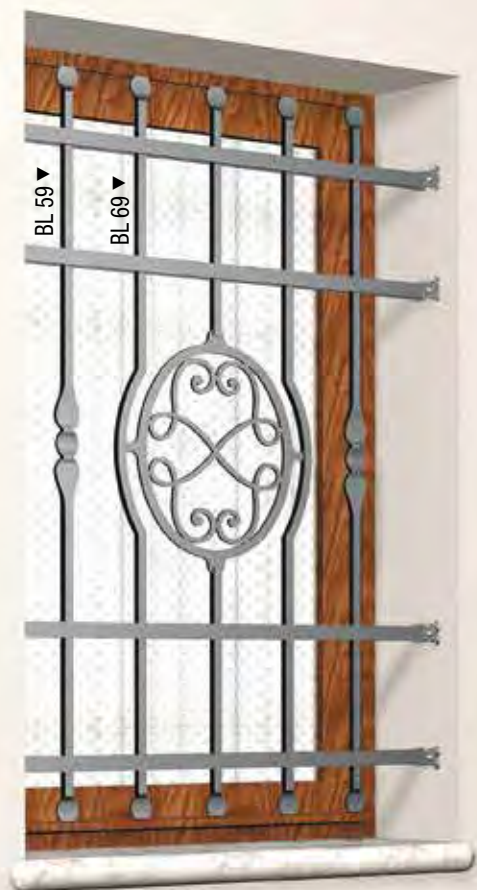

ART. BL 1



ART. BL 2

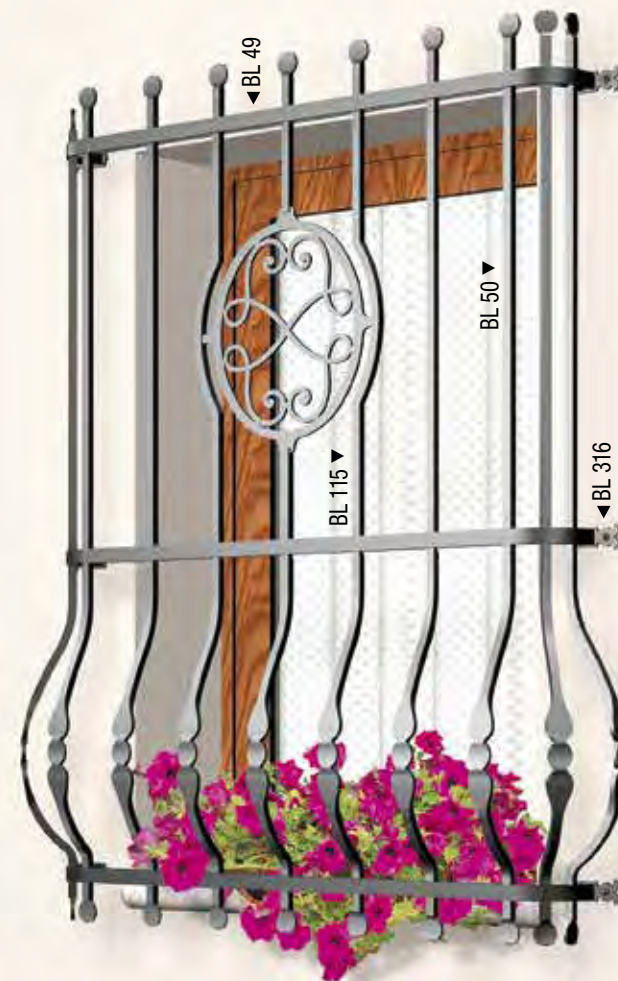

ART. BL 3





ART. BL 4

ART. BL 5

BL 224 ▼

BL 323

BL 70 ▼

BL 212

BL 242 ▼

BL 250

BL 80 ▼

BL 81

BL 324

BL 325

BL 194 ▼

BL 130 ▼

BL 326

BL 327

BL 328

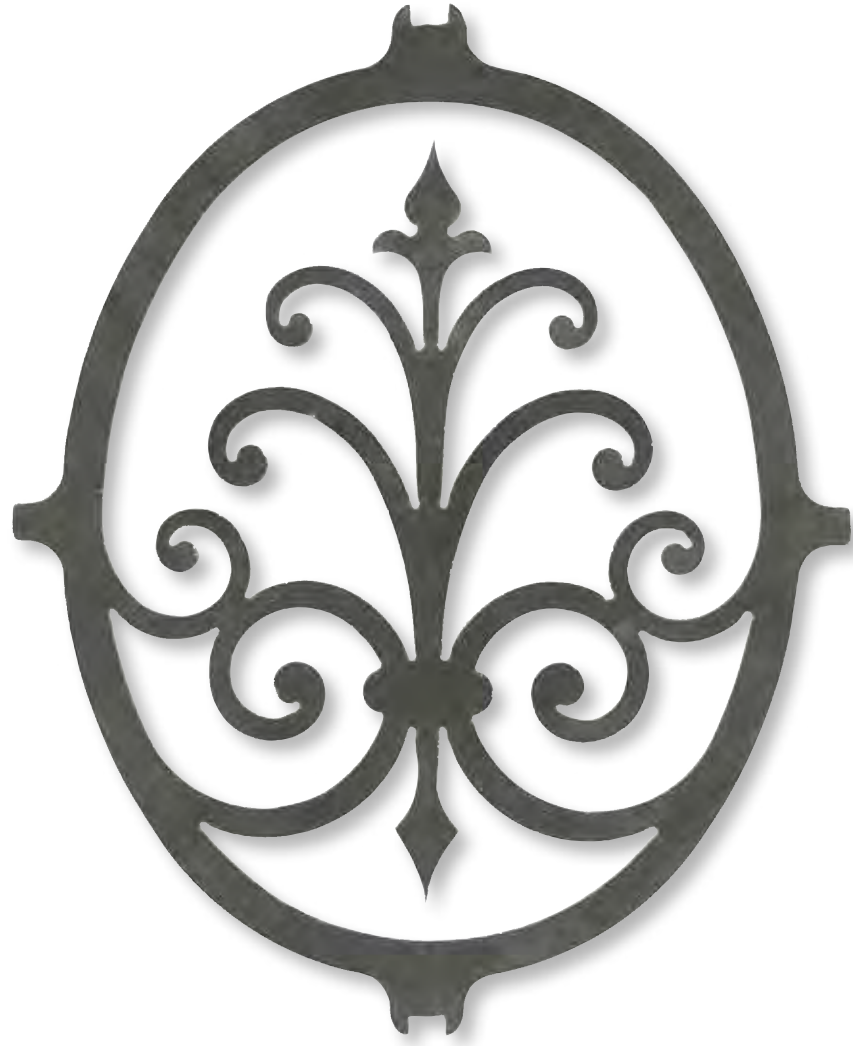
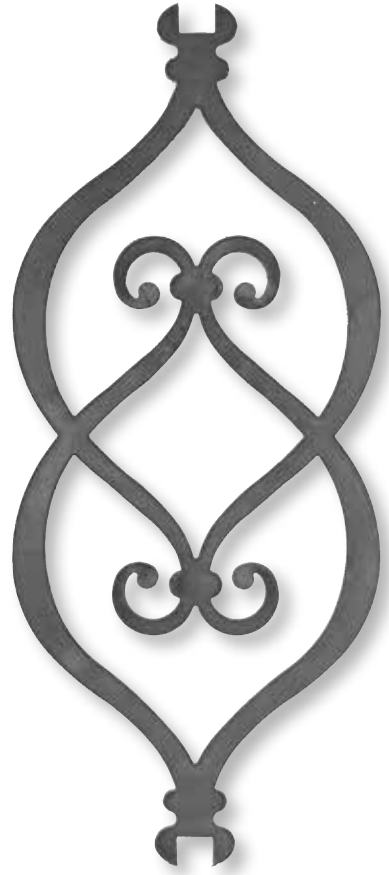

CASA GAIA



MARCO REGISTRATO
RIPRODUZIONE VIETATA



ART. BL 6



ART. BL 7



ART. BL 8



BL 122 ▼

BL 98 ▼

BL 97 ▼

BL 122 ▼

BL 82 ▼

BL 124 ◀



ART. BL 9

ART. BL 10

- BL 222 ▼
- BL 252 ◀
- BL 323 ◀
- BL 214 ▲
- BL 251 ◀
- BL 248 ▼
- BL 80 ▼
- BL 83 ▼
- BL 71 ▼
- BL 324 ◀
- BL 325 ◀
- BL 137 ▼
- BL 200 ▼
- BL 326 ▶
- BL 327 ▲
- BL 328 ▲

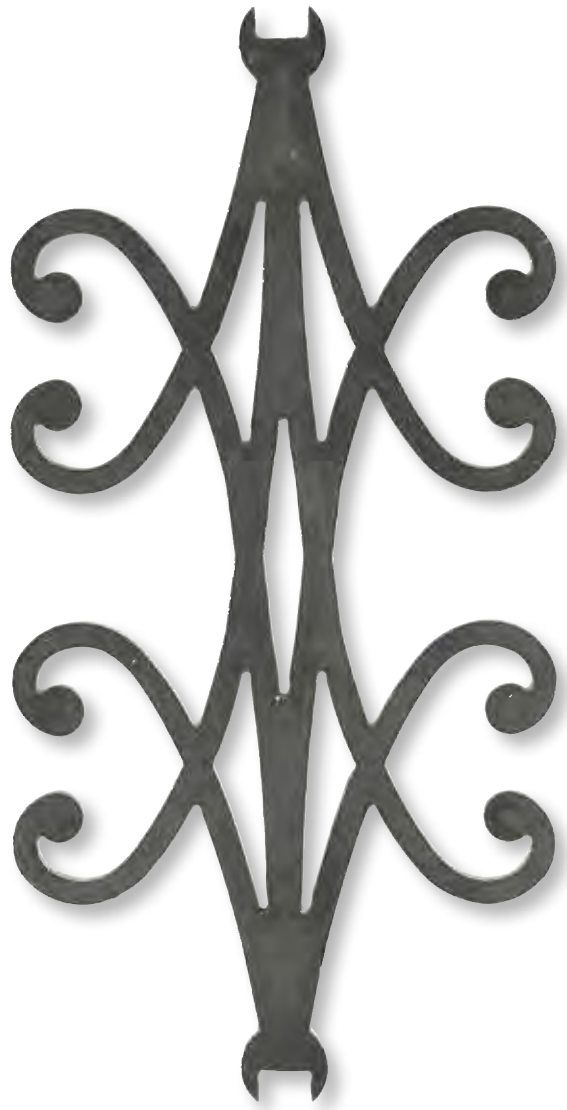

CASA CAMILLA



MARCO REGISTRATO
RIPRODUZIONE VIETATA



BL 61 ▼

ART. BL 11



BL 72 ▼

BL 84 ◀

BL 320 ▲ ▲ BL 321

BL 330 ▼

ART. BL 12

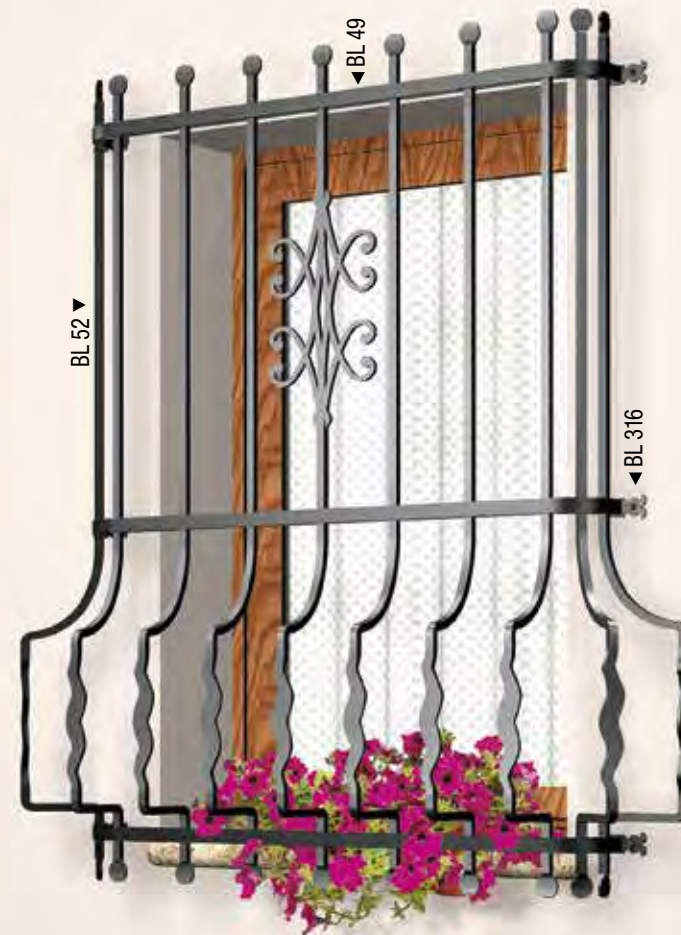

BL 49 ◀

BL 52 ▼

BL 316 ◀

ART. BL 13



BL 100 ▼



BL 99 ▼

◀ BL 84





ART. BL 14

ART. BL 15

BL 325 - BL 324 ▼
BL 254
BL 220

BL 323

BL 243 ▼

BL 253

BL 72 ▼

BL 84

BL 141 ▼

BL 224 ▼

BL 271

BL 270

BL 270

BL 270

BL 280 - BL 370

BL 326
BL 327

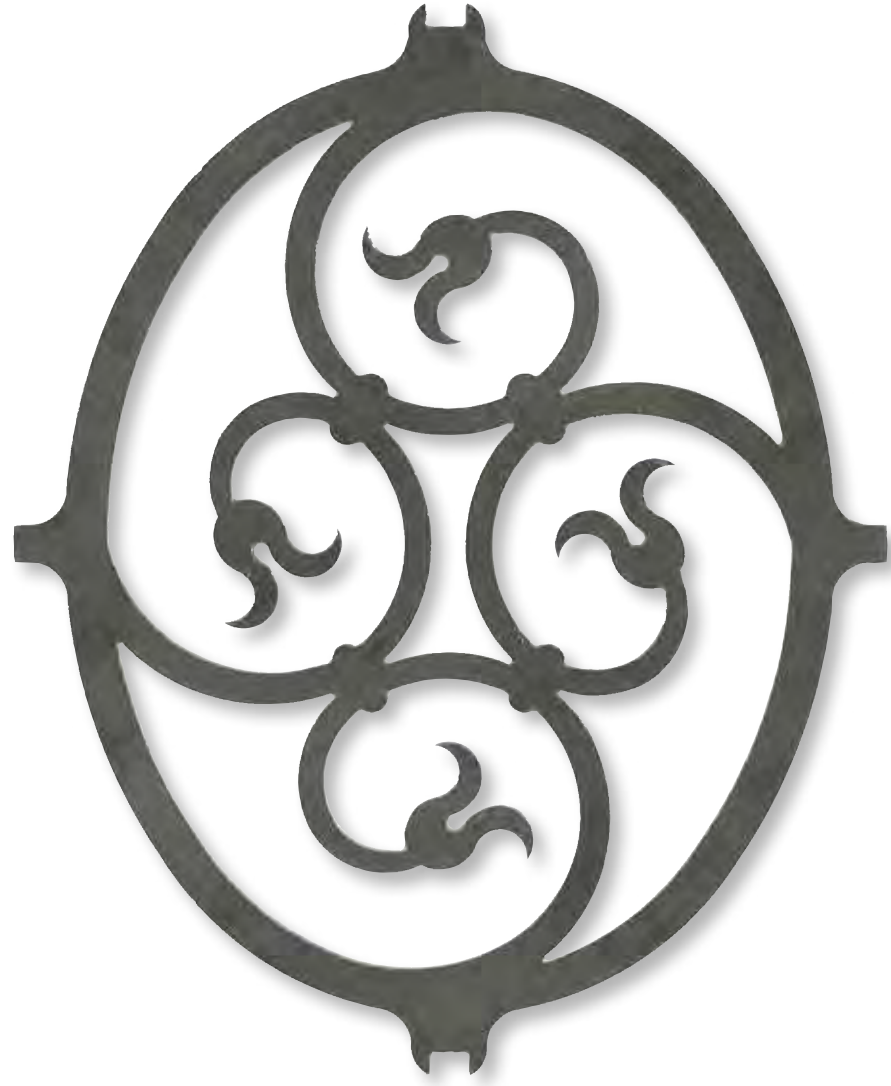
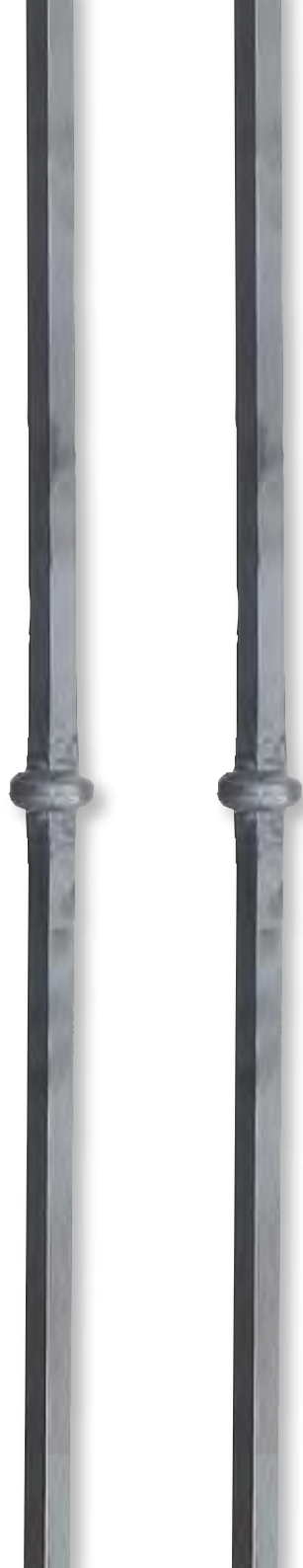

CASA MARIANNA





ART. BL 16



ART. BL 17



ART. BL 18







ART. BL 19

ART. BL 20

◀ BL 256

◀ BL 215

◀ BL 255

▶ BL 246

▶ BL 223

◀ BL 226

▶ BL 323

▶ BL 80

▶ BL 73

▶ BL 324
▶ BL 325

▶ BL 151

▶ BL 198

▶ BL 86

▶ BL 326

▶ BL 327

▶ BL 328

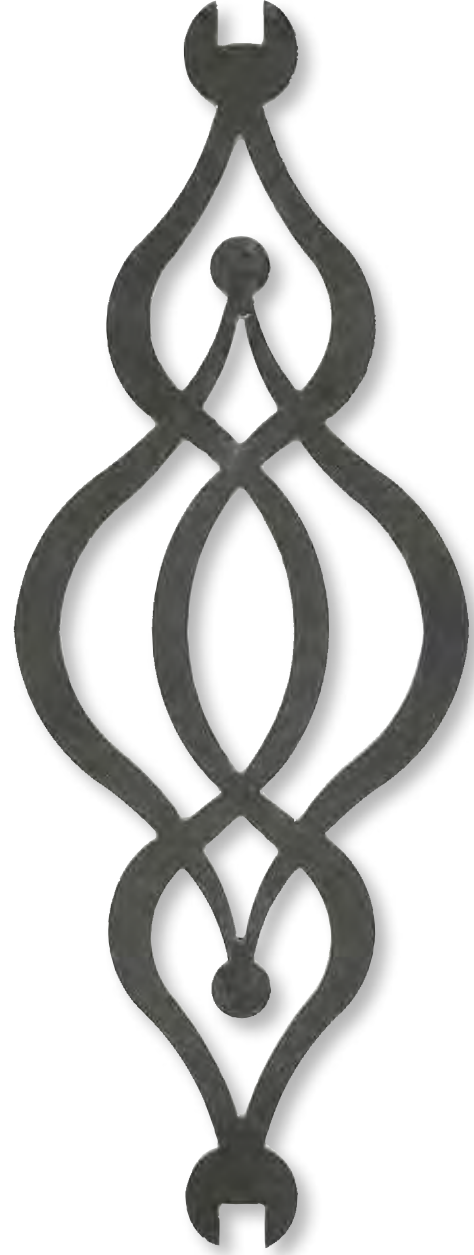

CASA SABINA





ART. BL 21



ART. BL 22

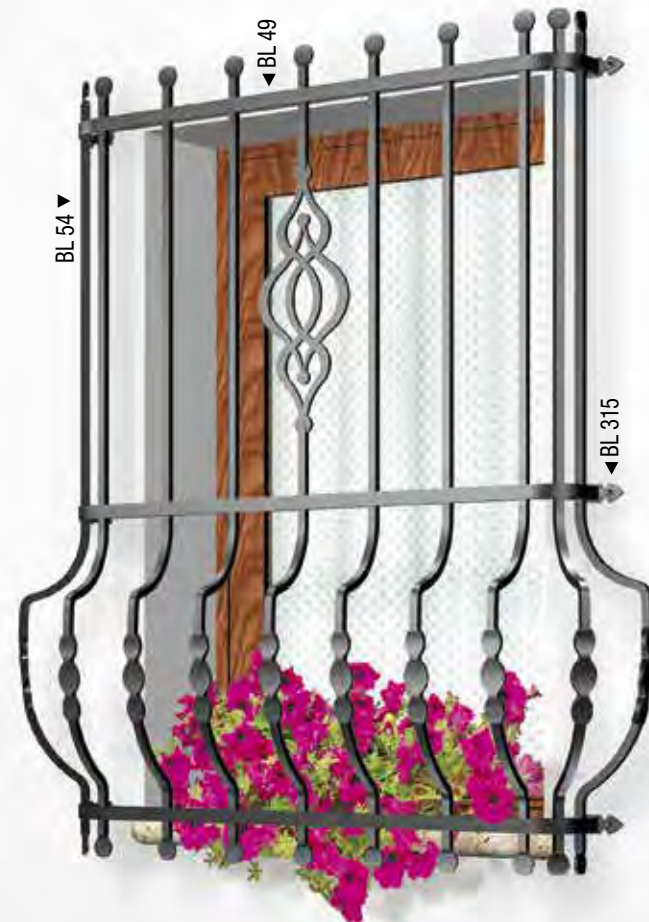

ART. BL 23



BL 104 ▼



BL 103 ▼

▼ BL 87





ART. BL 24

ART. BL 25

BL 325 - BL 324 ▼

BL 221 ▼

BL 323

BL 158 ▼

BL 87 ▼

BL 158 ▼

BL 273

BL 272

BL 280 - BL 370 ▲

BL 326

BL 327 ▲

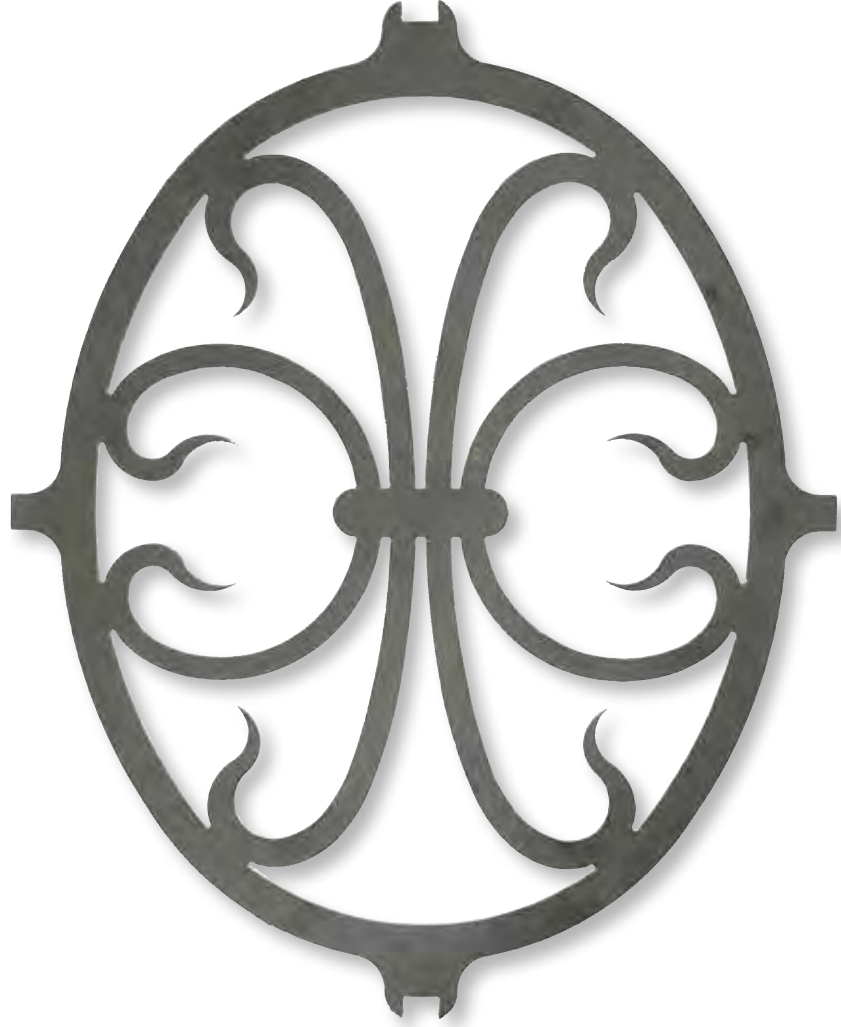

CASA MILENA





ART. BL 26



ART. BL 27



ART. BL 28



BL 106 ▼



BL 105 ▼

BL 115 ▼

▼ BL 88





ART. BL 29

ART. BL 30

◀ BL 258

BL 223 ▶

BL 324 ▶

BL 325 ▶

◀ BL 323

BL 326 ▶

▲ BL 327

BL 212 ▼

◀ BL 257

◀ BL 88

BL 75 ▼

BL 80 ▼

▶ BL 246

BL 162 ▼

◀ BL 226

▲ BL 328

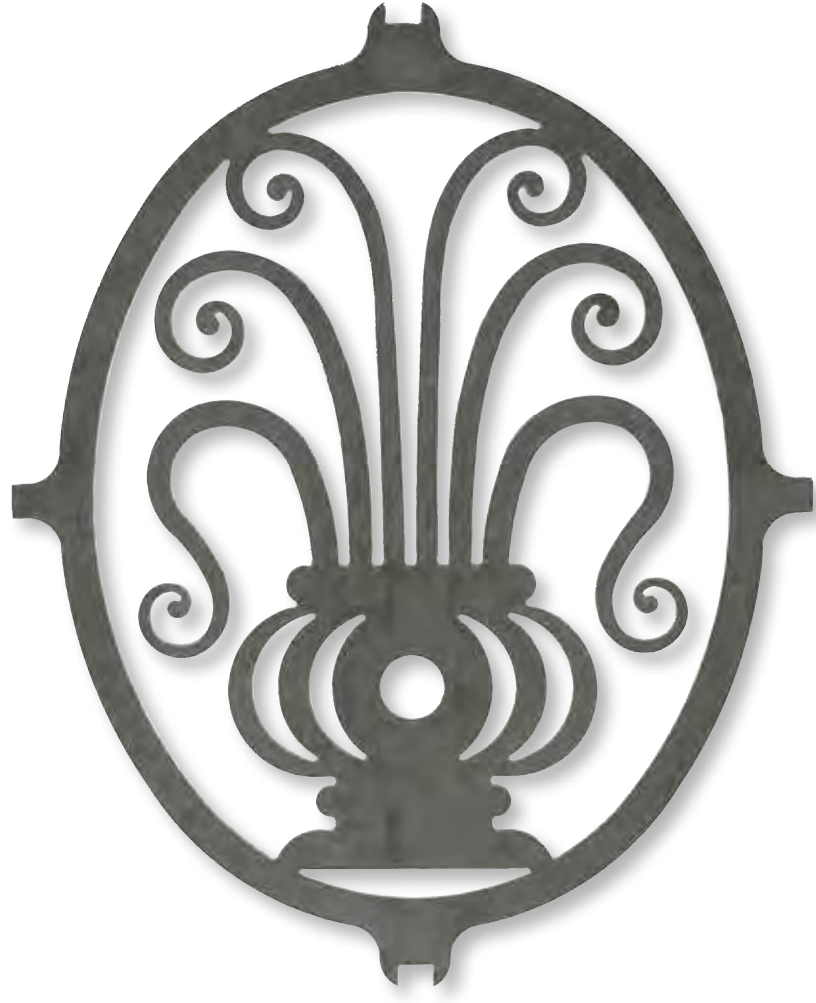
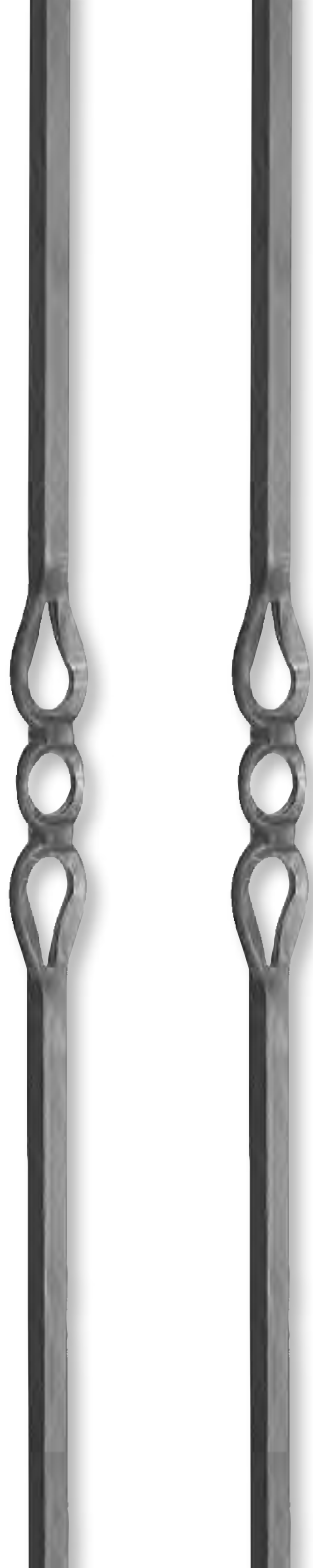
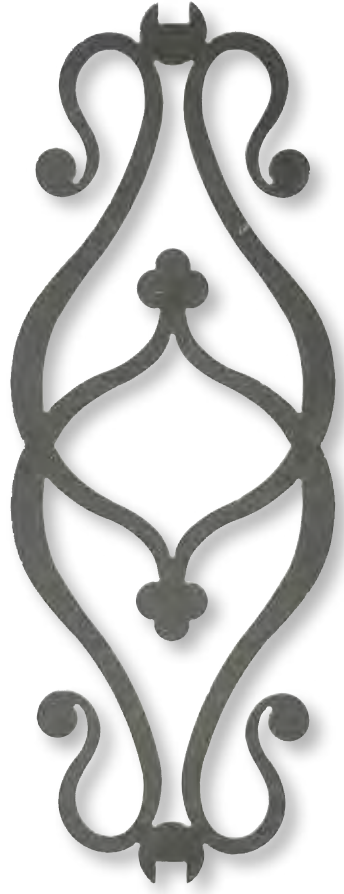

CASA BEATRICE



MARCO REGISTRATO
RIPRODUZIONE VIETATA



ART. BL 31



ART. BL 32

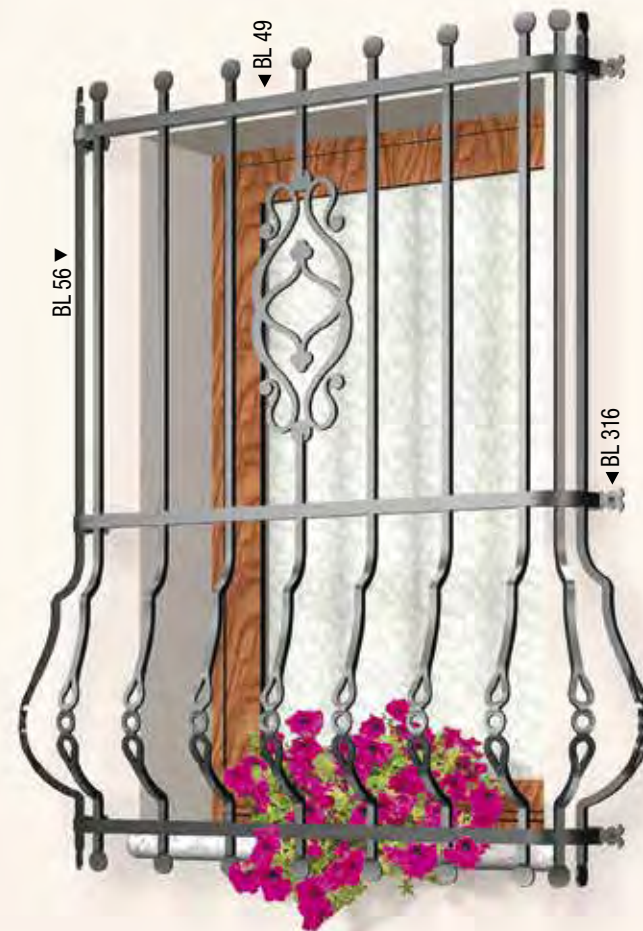

ART. BL 33

BL 122 ▼

BL 108 ▼



BL 107 ▼

BL 122 ▼

BL 89 ▼

BL 124 ◀





ART. BL 34

ART. BL 35

BL 324
BL 325

BL 260

BL 227

BL 323

BL 90

BL 326

BL 327

BL 214

BL 76

BL 328

BL 239

BL 80

BL 259

BL 164

BL 90

BL 225

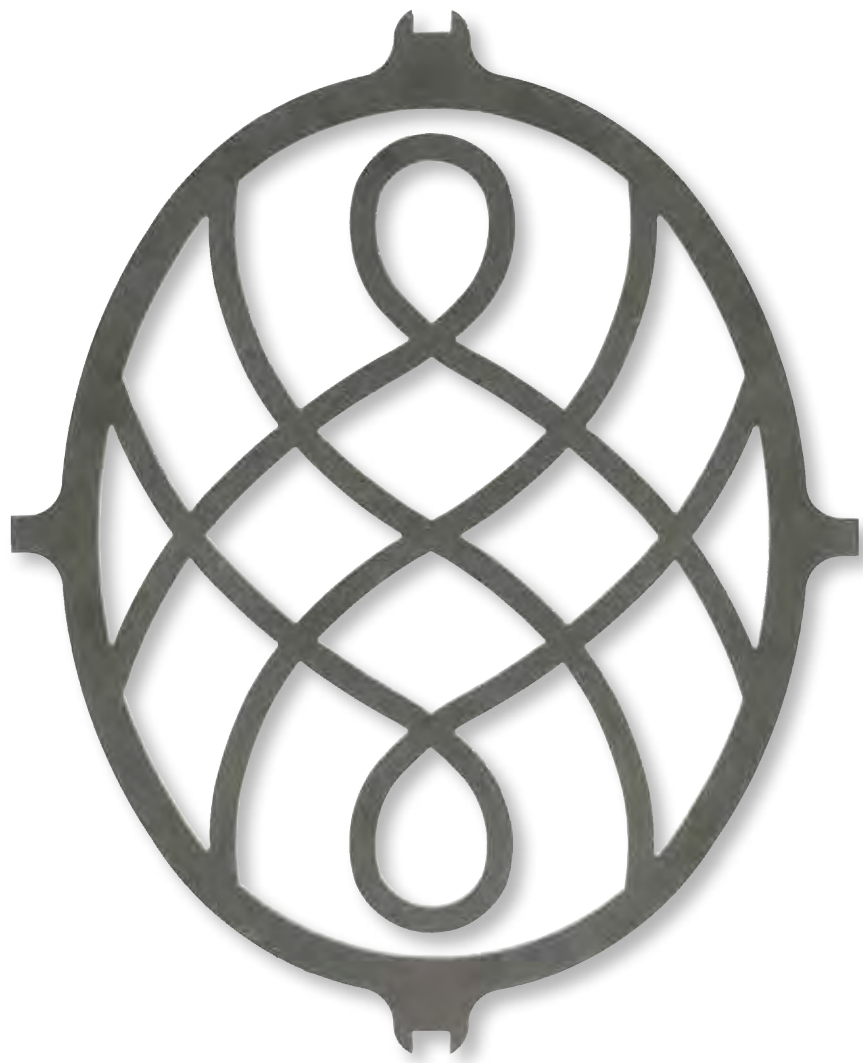

CASA SERENA



MARCO REGISTRATO
RIPRODUZIONE VIETATA



ART. BL 36



ART. BL 37



ART. BL 38







ART. BL 39

ART. BL 40

BL 325 ▶

▶ BL 324

◀ BL 323

BL 192 ▼

▶ BL 91

▶ BL 224

BL 175 ▼

BL 275

BL 274

BL 280 - BL 370

◀ BL 326

BL 327

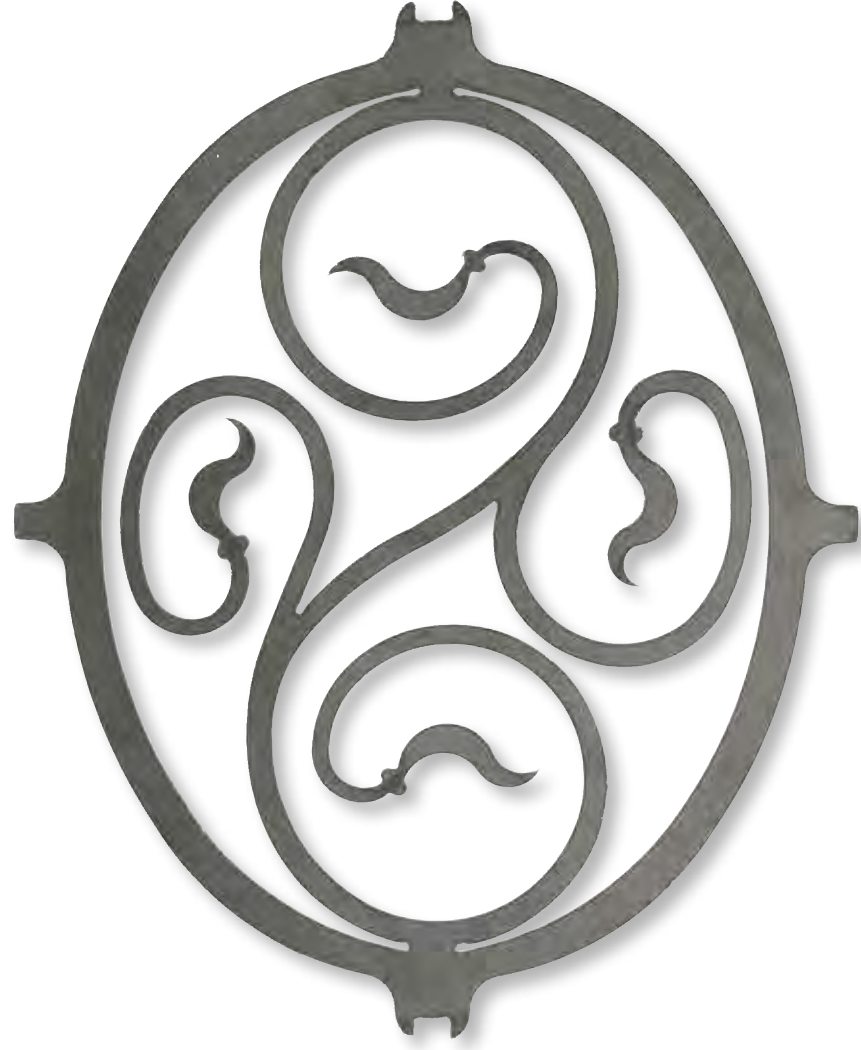

CASA GISELLA



MARCHIO REGISTRATO
RIPRODUZIONE VIETATA

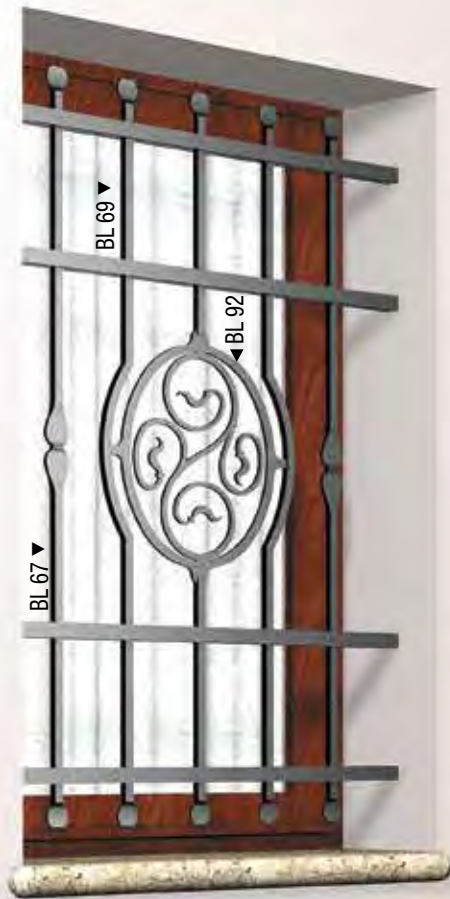

ART. BL 41



ART. BL 42



ART. BL 43





ART. BL 44

ART. BL 45

BL 325

BL 262

BL 237

BL 261

BL 222

BL 92

BL 323

BL 78

BL 80

BL 183

BL 189

BL 277

BL 276

BL 280 - BL 370

BL 326

BL 327

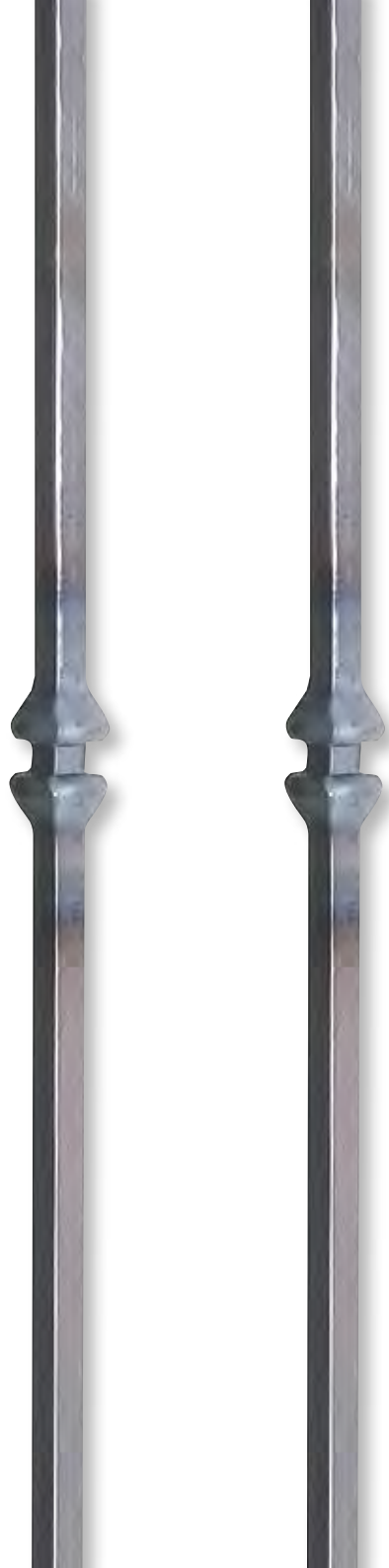

CASA ROSSANA



MARCO REGISTRATO
RIPRODUZIONE VIETATA



ART 1043 ▼

◀ BL 315

ART 1050 ▼

ART. 1007



ART 1033 ▼

BL 321 ▲ ▲ BL 320

◀ ART 1050

▼ BL 330

ART. 1008

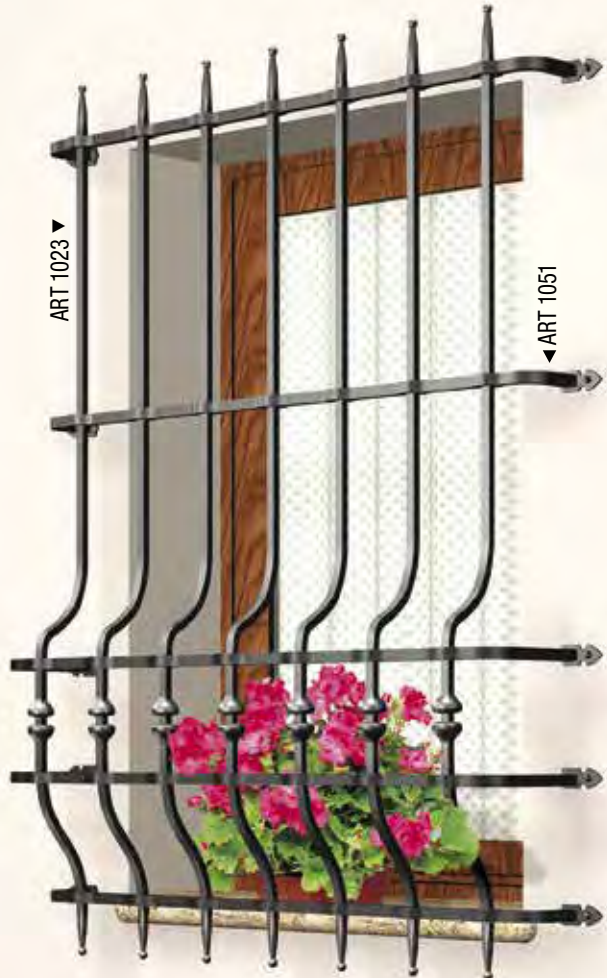

ART 1023 ▼

◀ ART 1051

ART. 1006



BL 122 ▼

ART 1067 ▼



ART 1066 ▼

BL 122 ▼

BL 124 ◀





◀ BL 252

◀ BL 214

◀ BL 251

◀ ART 1214

◀ BL 222

◀ BL 323

◀ BL 324
◀ BL 325

ART 1112 ▼

ART 1183 ▼

ART. 1009

BL 326 ▶

▲ BL 327

▲ BL 328

ART. 1010



CASA MARISA



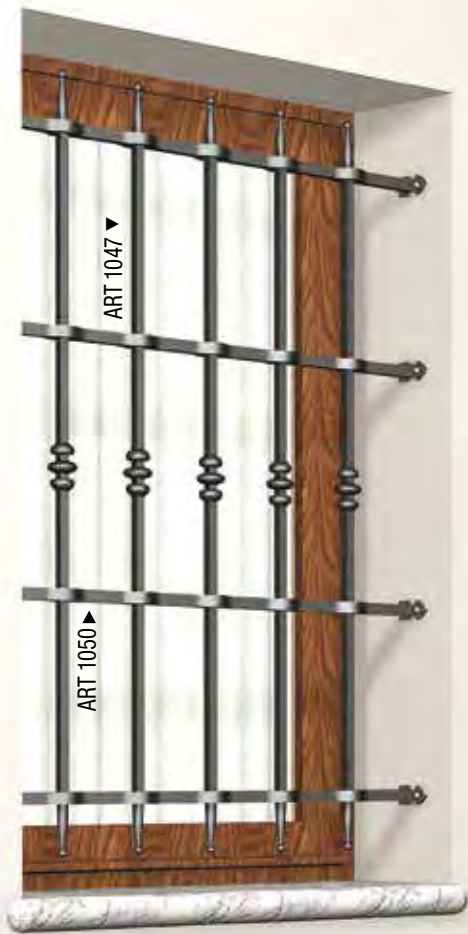

ART 1047 ▼

ART 1050 ▶

ART. 1015



ART 1037 ▼

ART 1050 ◀

BL 321 ▲

BL 320 ▲

BL 330 ▼

ART. 1016



ART 1027 ▼

ART 1051 ◀

BL 315 ◀

ART. 1014



ART 1075 ▼



ART 1074 ▼





ART. 1017

ART. 1018

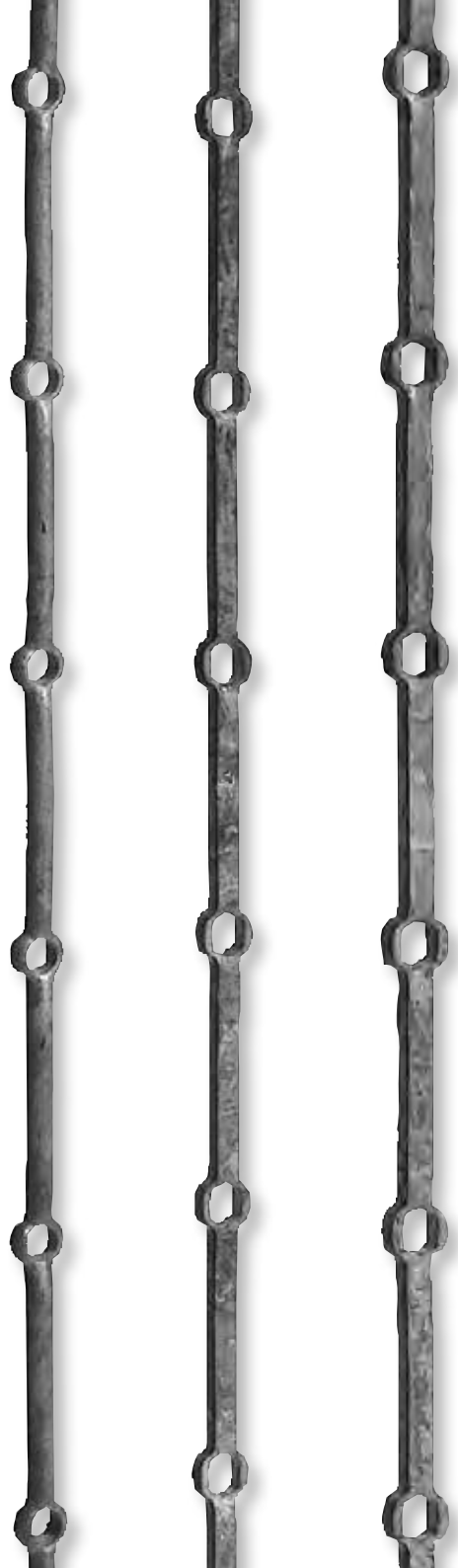

CASA OFELIA





ART. 1241

L'inferriata sporgente (Art. 1240);
l'inferriata interna (Art. 1241);
il cancelletto porta (Art. 1242)
si consegnano sia in ferro tondo che
quadro da 12 / 14 / 16 su misura
trasmettendoci la distinta delle barre
forate.



▲ BL 320
▲ BL 321

▼ BL 330



ART. 1240

ART. 1242

Le barre in ferro quadro forate e non forate
si possono consegnare battute

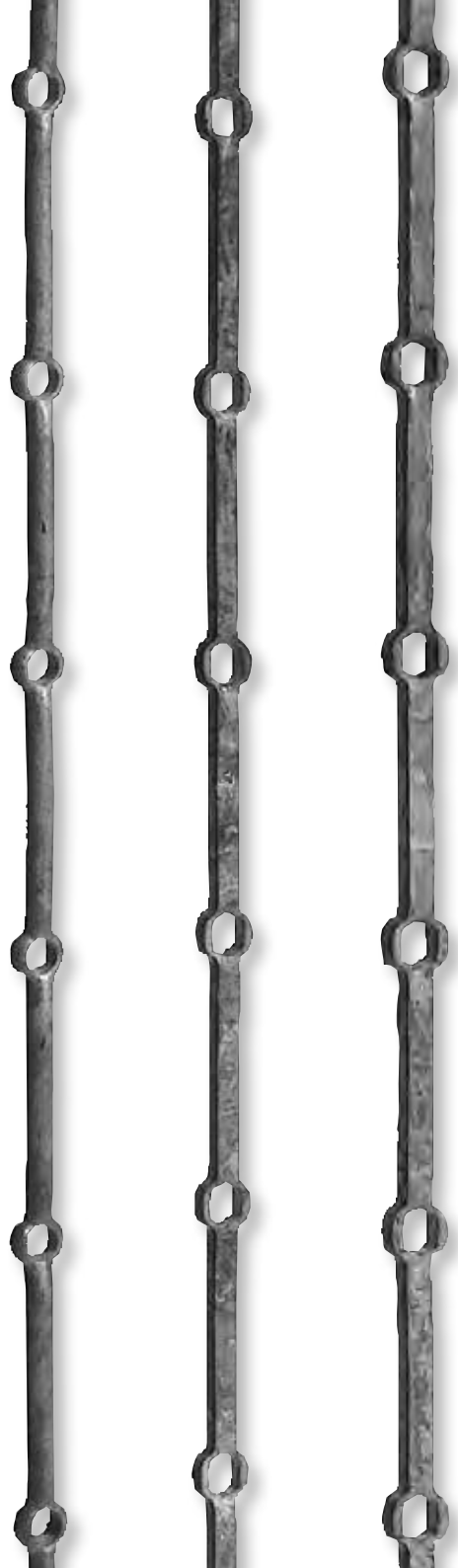

CASA LORENA



MARCO REGISTRATO
RIPRODUZIONE VIETATA



ART. 1247

L'inferriata sporgente (Art. 1246);
 l'inferriata interna (Art. 1247);
 il cancelletto porta (Art. 1248)
 si consegnano sia in ferro tondo che
 quadro da 12 / 14 / 16 su misura
 trasmettendoci la distinta delle barre
 forate.



BL 321 ▲ ▲ BL 320

▼ BL 330



ART. 1246

ART. 1248

Le barre in ferro quadro forate e non forate
 si possono consegnare battute





ART 30 ▶

◀ BL 315

ART. BL 340



BL 70 ▼

ART 252 ▼

ART 49 ▶

▼ BL 330



◀ BL 49

BL 59 ▼

▶ BL 320

▲ BL 321

ART. BL 342

ART. BL 341





ART. BL 343

ART. BL 344



CASA ELENA



MARCHIO REGISTRATO
RIPRODUZIONE VIETATA



◀ ART 40

◀ ART 250

BL 64 ▼

ART. BL 345



BL 75 ▼

BL 321 ▲ ▲ BL 320

▼ BL 330

ART. BL 346



◀ BL 49

BL 64 ▼

ART. BL 347





ART. BL 348

ART. BL 349



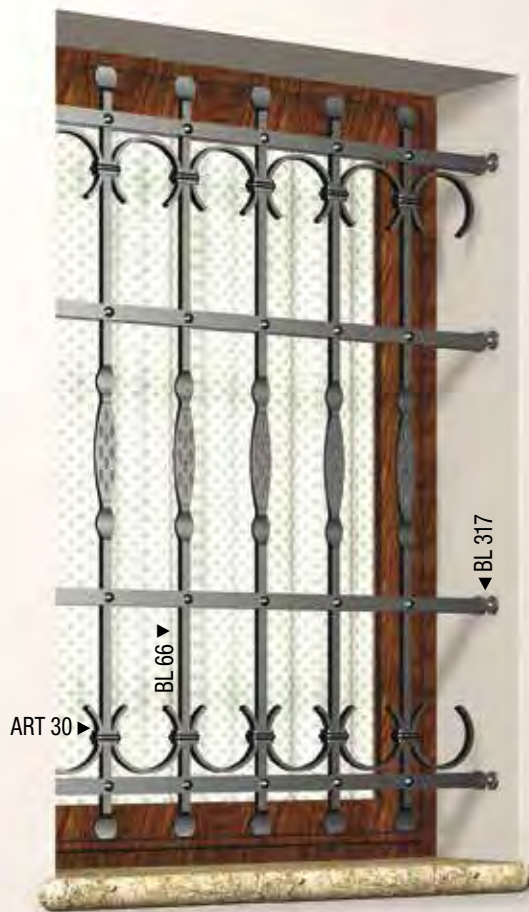

ART 30 ▶
BL 66 ▼
BL 317 ◀

ART. BL 350



BL 77 ▼
ART 232 ▲
ART 46 ▶
BL 330 ▼



BL 49 ◀
BL 66 ▼
BL 321 ▲
BL 320 ▲

ART. BL 352

ART. BL 351







ART 46 ▶

◀ BL 323

◀ BL 326

BL 327

ART. BL 353

ART. BL 354

BL 66 ▼

◀ ART 560

ART 30 ▼

ART 232 ▼

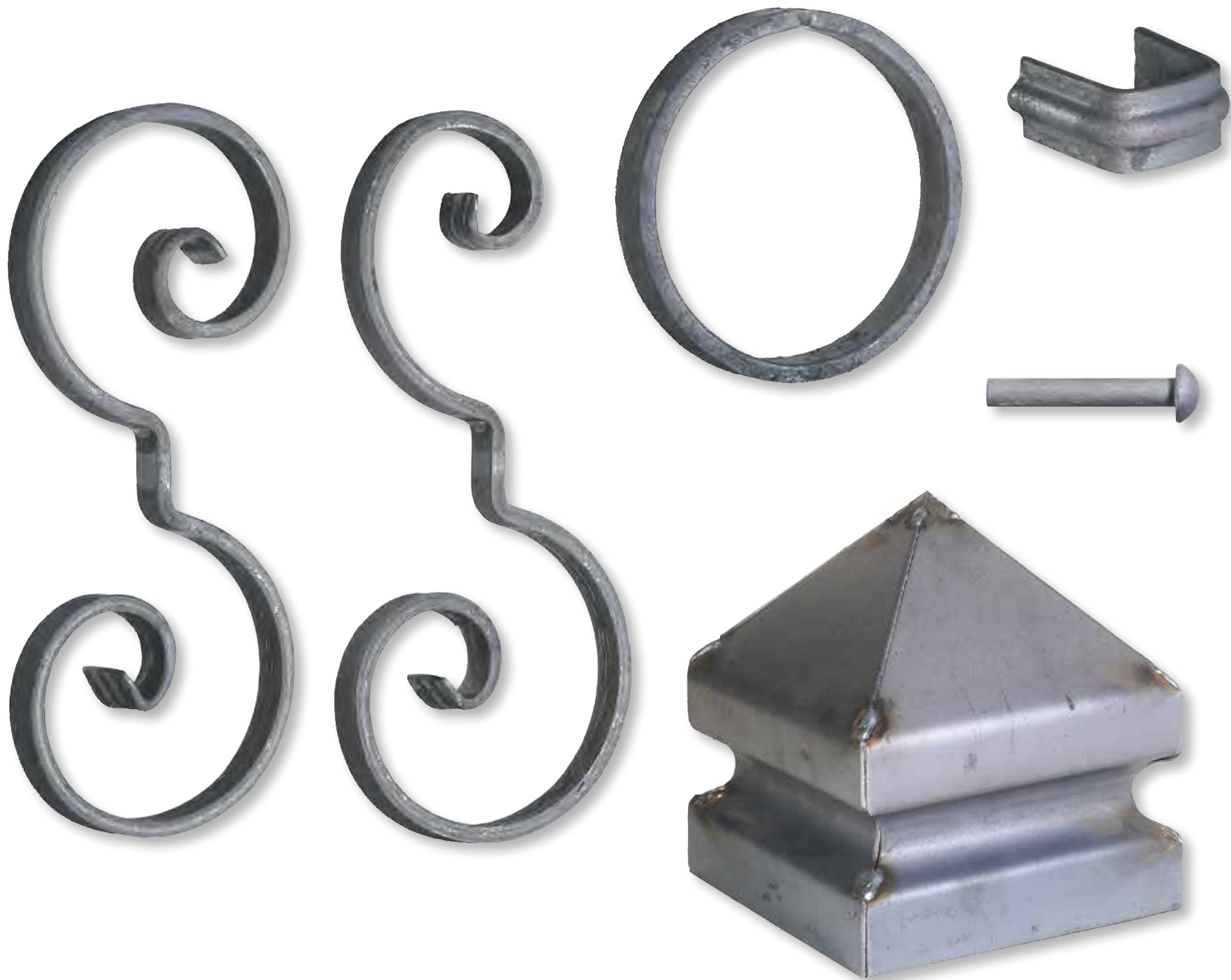



ART. BL 355



BL 321 ▲ ▲ BL 320



ART. BL 357

ART. BL 356







ART. BL 358

ART. BL 359

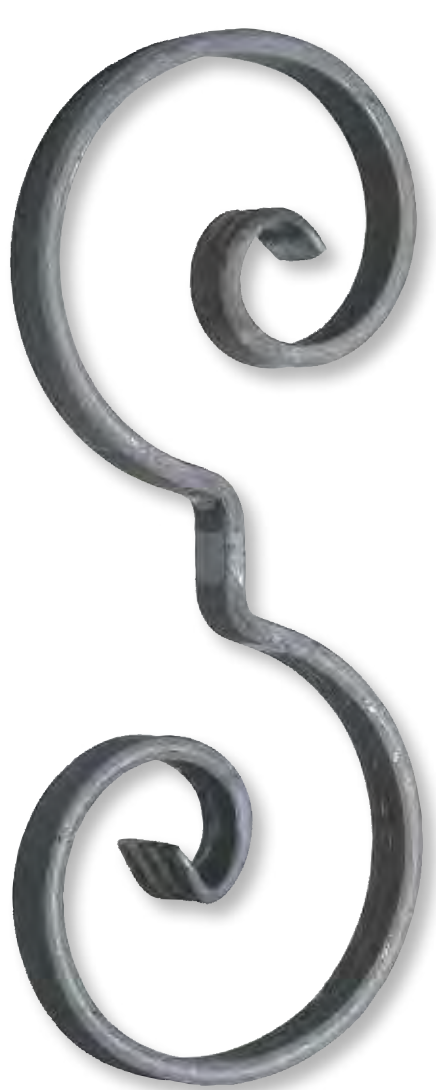

CASA DELIA



MARCO REGISTRATO
RIPRODUZIONE VIETATA



ART. BL 360



ART. BL 361



ART. BL 362







ART. BL 363

ART. BL 364

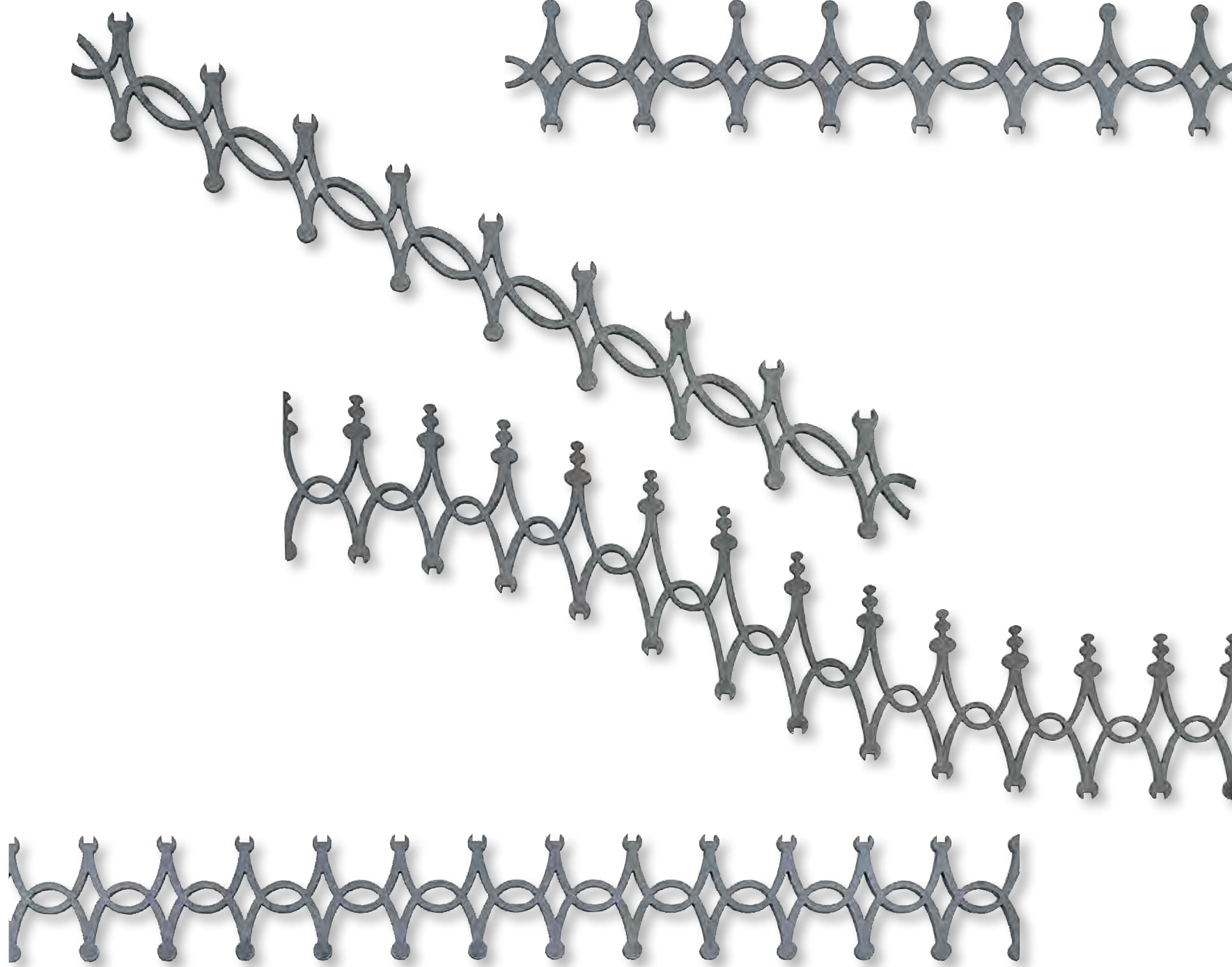

CASA FIORELLA



MARCO REGISTRATO
RIPRODUZIONE VIETATA



ART. A-01

ART. A-02



ART. A-03





ART. A-04



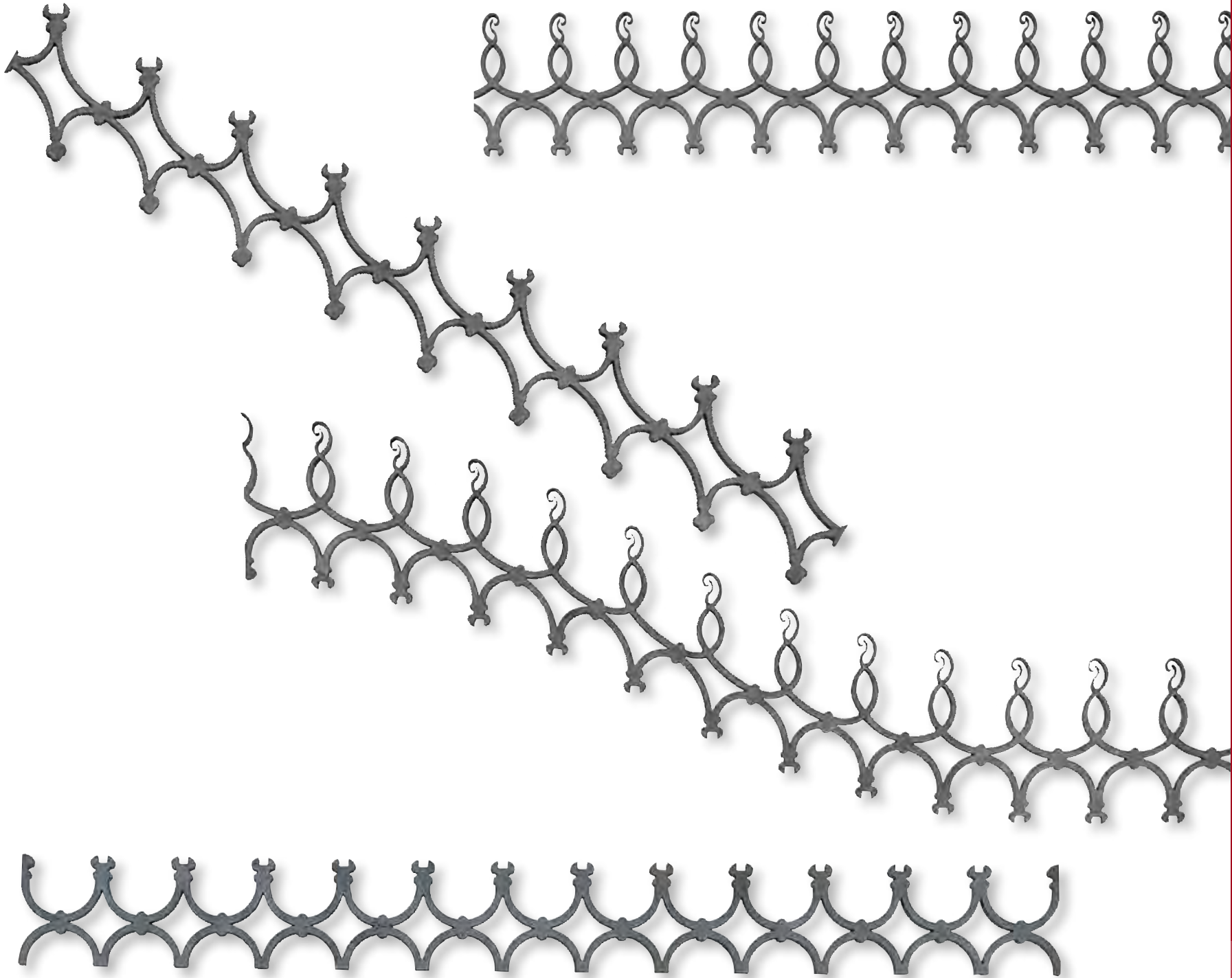

CASA ERICA



MARCO REGISTRATO
RIPRODUZIONE VIETATA



ART. A-06

ART. A-07



ART. A-08



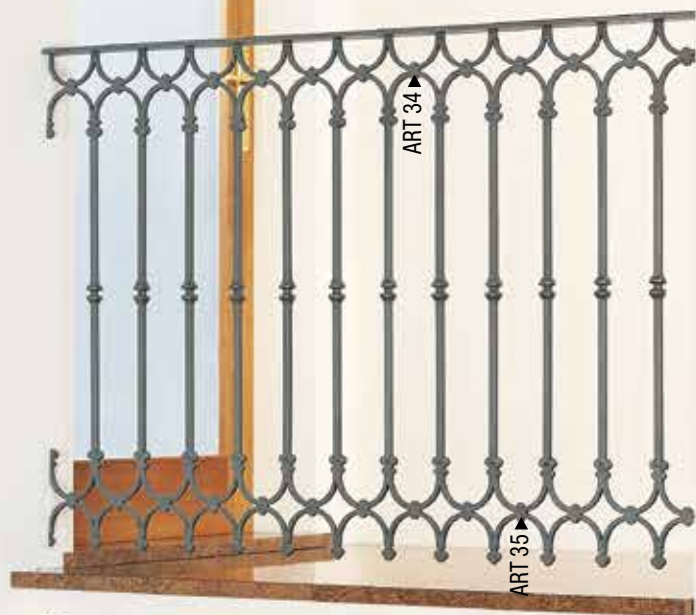

ART. A-09



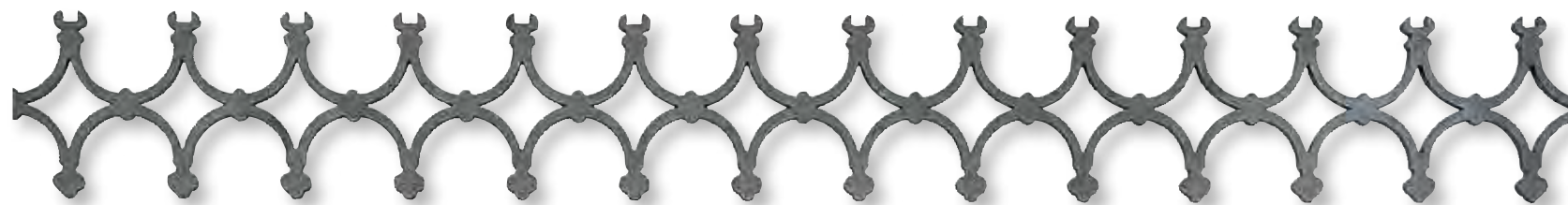

CASA MELISSA



MARCHIO REGISTRATO
RIPRODUZIONE VIETATA

ART. A-11



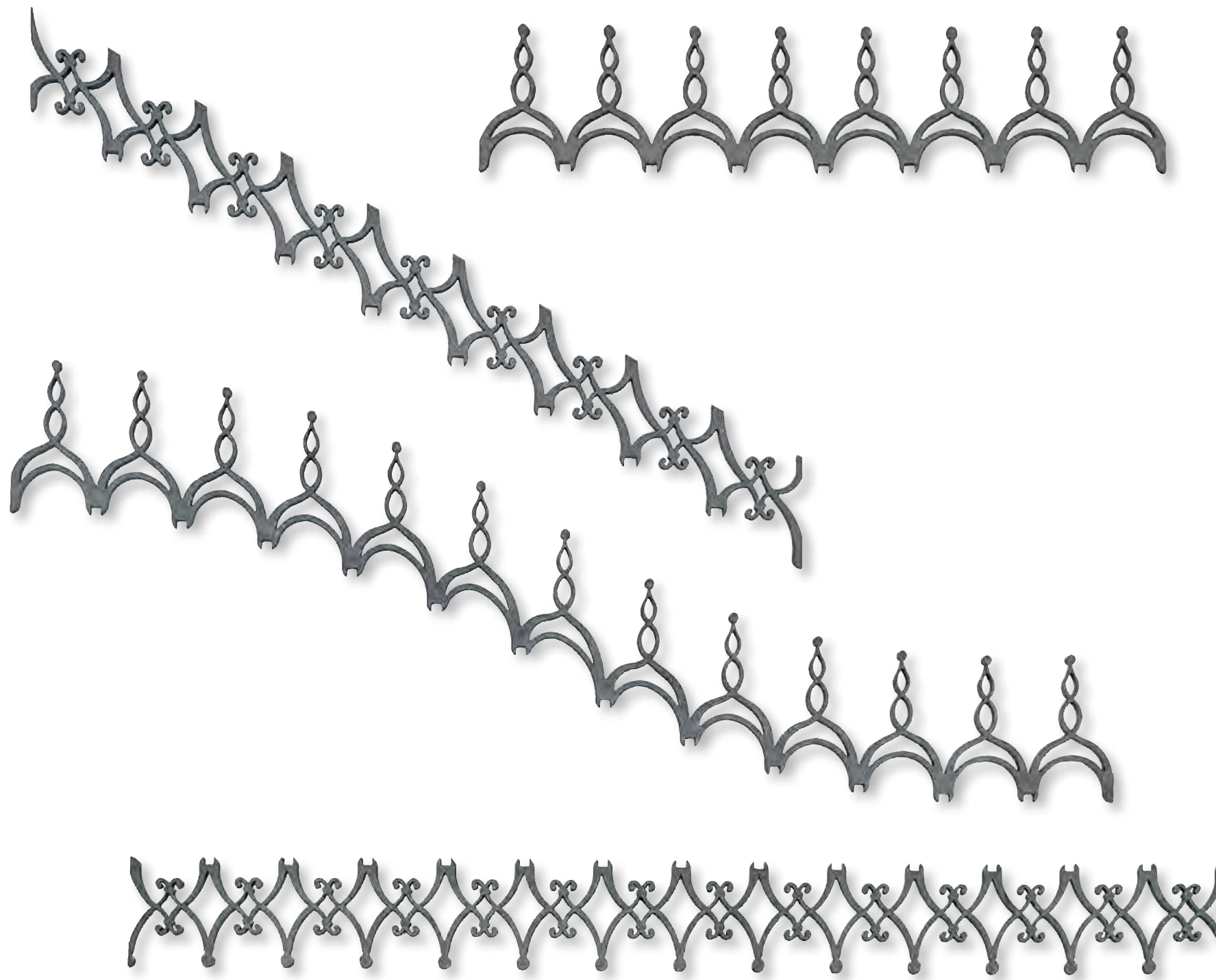

CASA MARGHERITA



MARCO REGISTRATO
RIPRODUZIONE VIETATA



ART. A-13

ART. A-14



ART. A-15





ART 63 ▶

ART 64 ▶



ART 61 ▶

ART 65 ▼

ART 62 ▶

◀ ART 66



ART. A-16



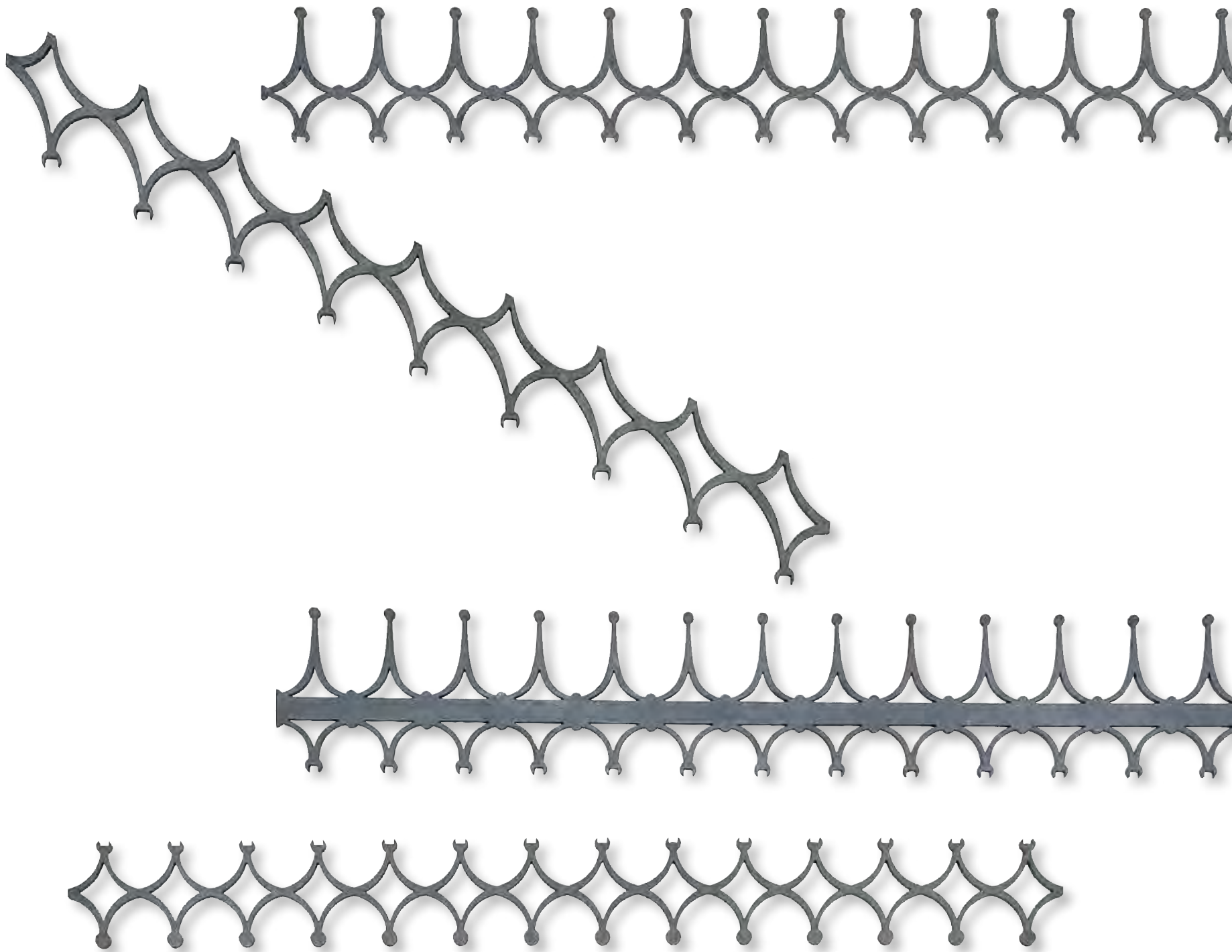

CASA FIORDALISO



MARCO REGISTRATO
RIPRODUZIONE VIETATA



ART. A-18

ART. A-19



ART. A-20





ART. A-21





Ar-Fer arte ferro srl

LO STILE NEL
FERRO
BATTUTO PER
LE VOSTRE
PIÙ BELLE
CANCELLATE,
RECINZIONI,
INFERRIATE E
RINGHIERE



FOTO 1



FOTO 2



FOTO 3



FOTO 4



FOTO 5



FOTO 6

CANCELLATE
SU MISURA
PER VOI

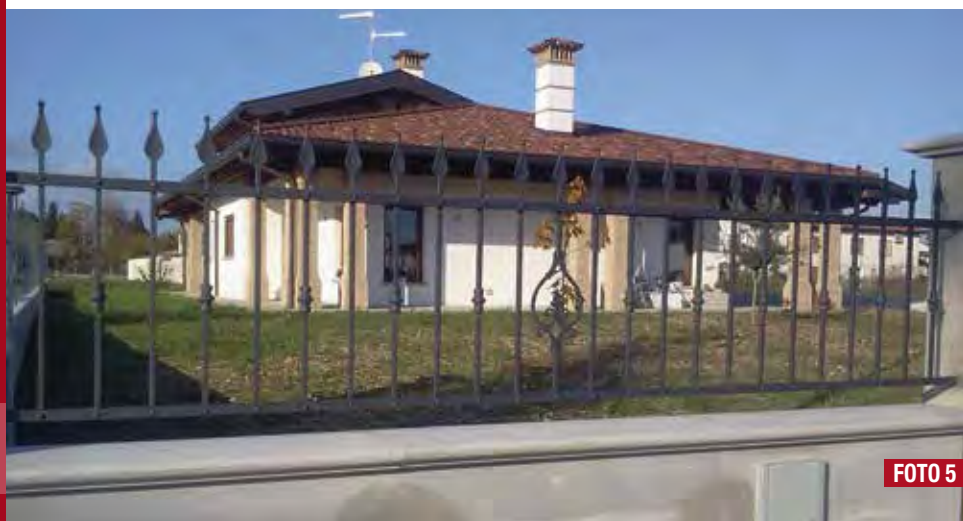

FOTO 1



FOTO 2



FOTO 3



FOTO 4



FOTO 5



FOTO 6



MARCO REGISTRATO
RIPRODUZIONE VIETATA

MOLTE
TIPOLOGIE
NEI DIVERSI
DESIGN



FOTO 1



FOTO 2



FOTO 3



FOTO 4



FOTO 5



FOTO 6



FOTO 1



FOTO 2



FOTO 3



FOTO 4



FOTO 5



FOTO 6



FOTO 7

L'ARMONIA
DELLO STILE
E IL
VANTAGGIO
DELLA
SICUREZZA



L'ESPERIENZA
DI 3
GENERAZIONI



FOTO 1



FOTO 2



FOTO 3



FOTO 4



FOTO 5



FOTO 6



MARCO REGISTRATO
RIPRODUZIONE VIETATA

DA 40 ANNI
AL VOSTRO
SERVIZIO



INFERRIATE
E PORTONCINI
PER LA
VOSTRA
ABITAZIONE





FOTO 1



FOTO 2



FOTO 3



FOTO 4



FOTO 5



FOTO 1



FOTO 2



FOTO 3



FOTO 4



FOTO 5



FOTO 6



Ar-Fer arte ferro srl

CUT DESIGN

50[°]
anniversario
1964 - 2014

INDICE



103 | INFERRIATE CANCELLETTI



127 | CANCELLETTI

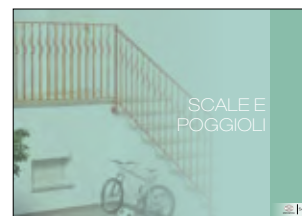

145 | SCALE E POGGIOLI



169 | CANCELLI E RECINZIONI

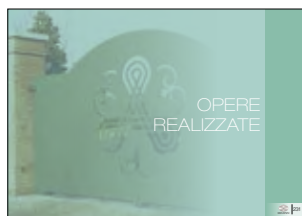

231 | OPERE REALIZZATE

Questo catalogo annulla e
sostituisce i precedenti.

Per l'ordinazione di tutti gli articoli
di questo catalogo, fare riferimento
all'"ALMANACCO" Ar Fer.



INFERRIATE CANCELLI



ART. 106



ART. 105



ART. 100





ART. 130



ART. 125



ART. 120





ART. 150



ART. 145



ART. 140





ART. 170



ART. 165



ART. 160





ART. AM 192



ART. AM 191



ART. AM 190





ART. 197



ART. 196



ART. 195





ART. 202



ART. 201



ART. 200





ART. 207



ART. 206



ART. 205





ART. AM 1049



ART. AM 1048



ART. AM 1047



ART. AM 1119



ART. AM 1118



ART. AM 1117





ART. AM 1129



ART. AM 1128



ART. AM 1127





ART. AM 1179



ART. AM 1178



ART. AM 1177





ART. AM 1219



ART. AM 1218



ART. AM 1217



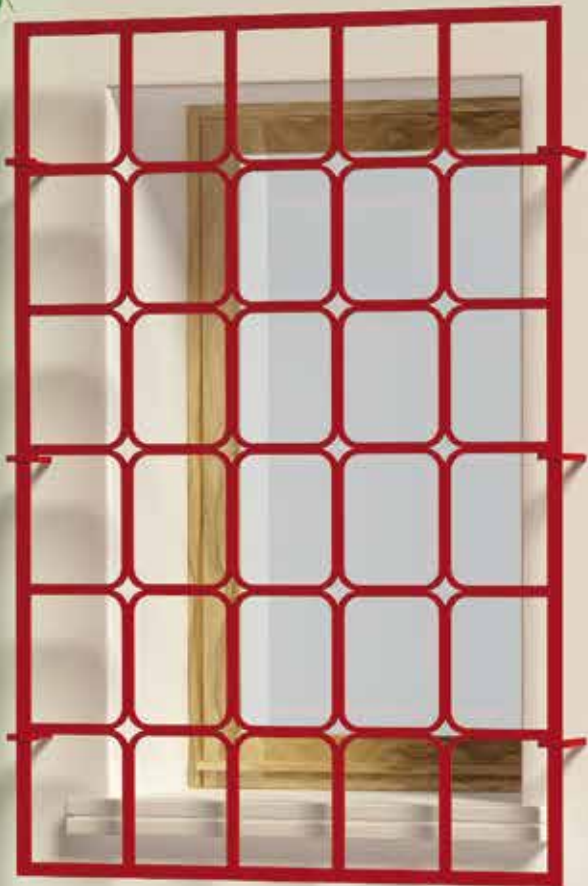

ART. AM 1249

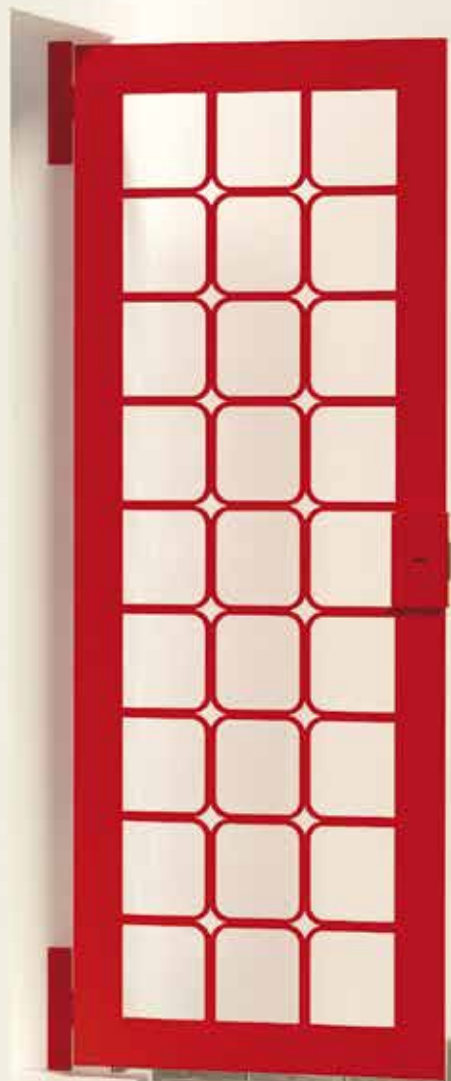

ART. AM 1248

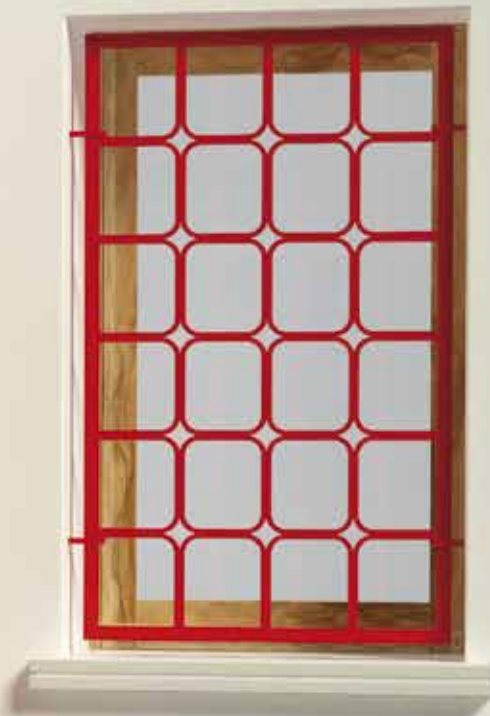

ART. AM 1247





ART. AM 1289



ART. AM 1288



ART. AM 1287





ART. AM 1299



ART. AM 1298

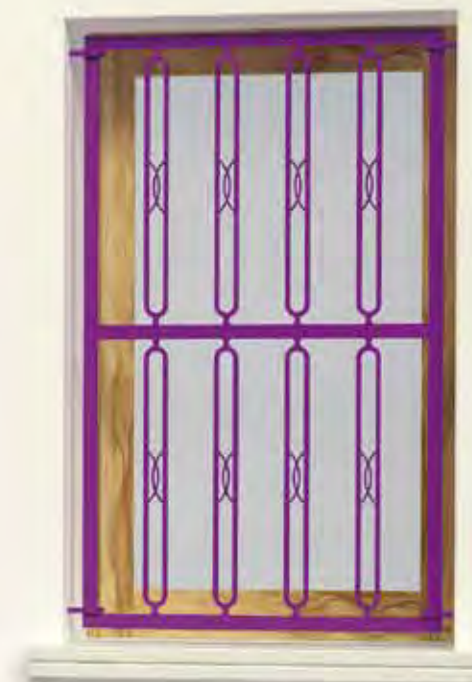

ART. AM 1297



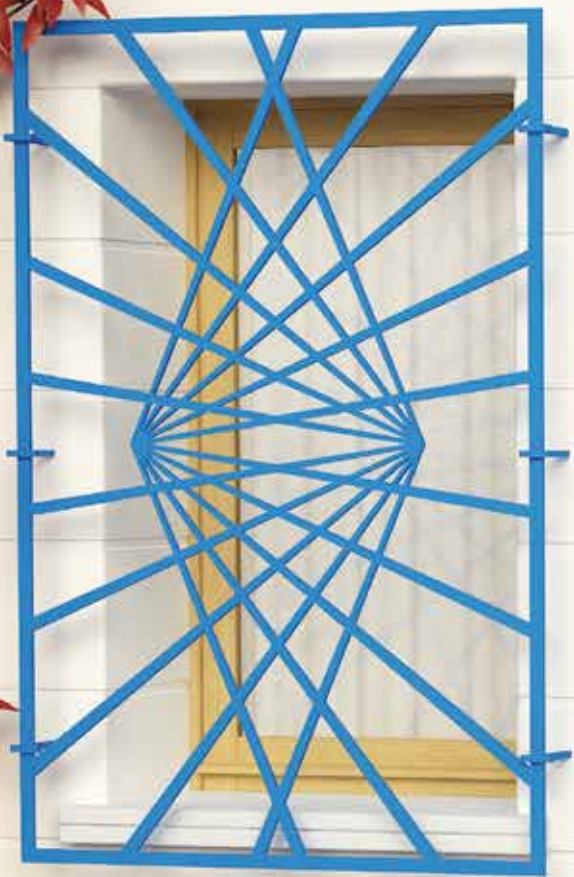

ART. AM 1349

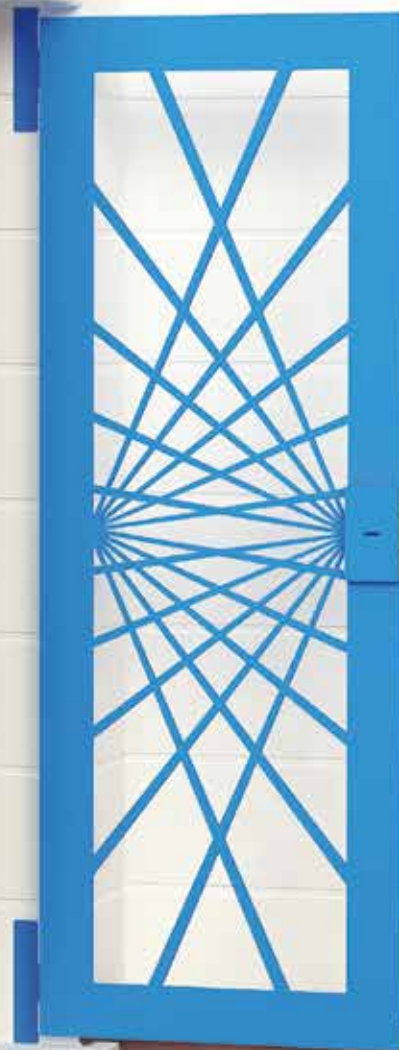

ART. AM 1348

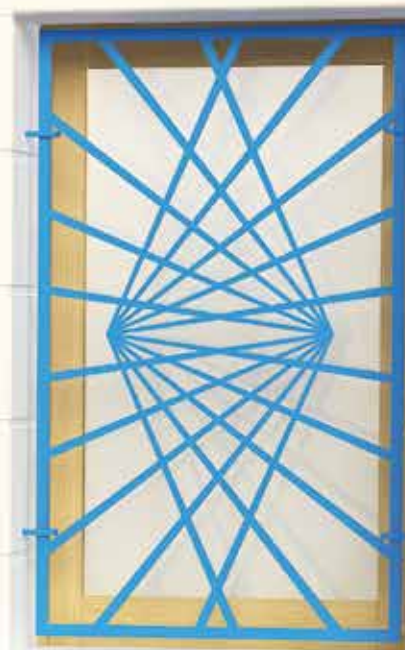

ART. AM 1347





ART. AM 1359

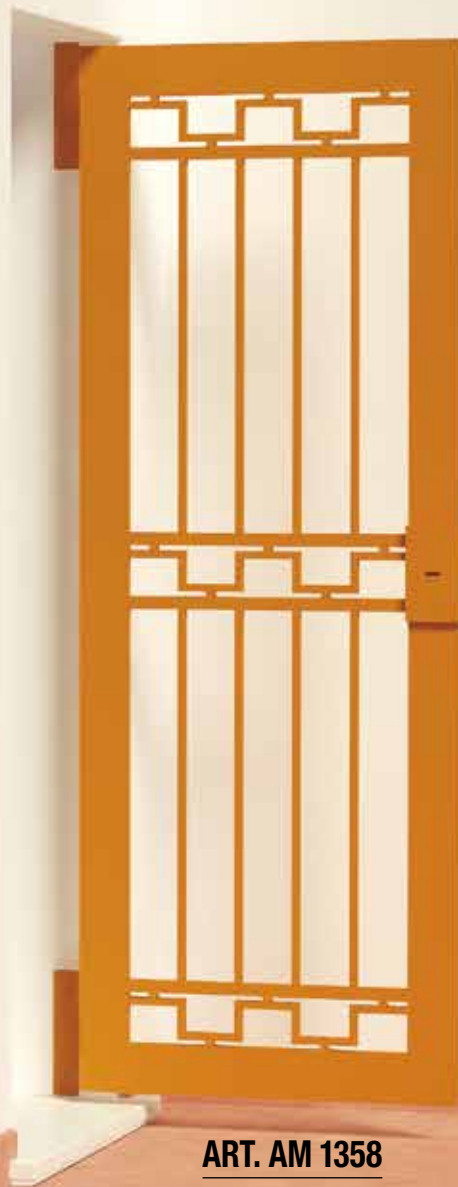

ART. AM 1358



ART. AM 1357



ART. AM 1459



ART. AM 1458



ART. AM 1457





ART. AM 1479

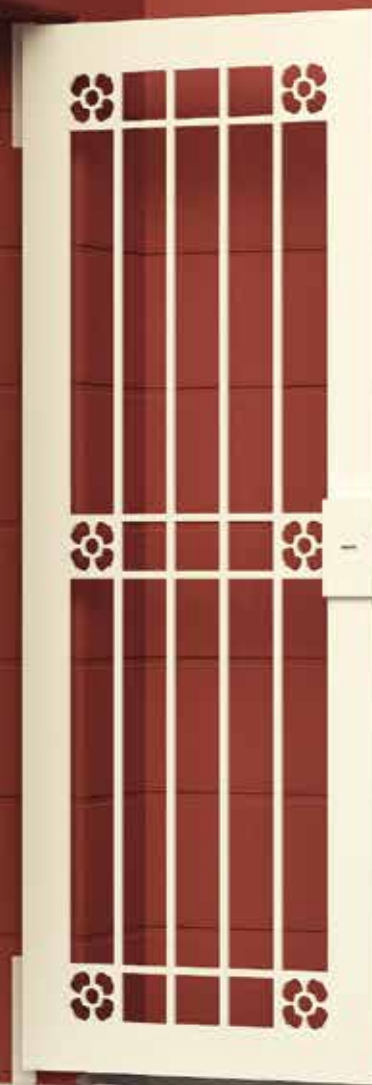

ART. AM 1478



ART. AM 1477





ART. AM 1489



ART. AM 1488



ART. AM 1487





ART. AM 1499



ART. AM 1497



ART. AM 1498



MARCHIO REGISTRATO
RIPRODUZIONE VIETATA



ART. AM 1509



ART. AM 1507



ART. AM 1508



CANCELLETTI



MARCHIO REGISTRATO
RIPRODUZIONE VIETATA



ART. 210

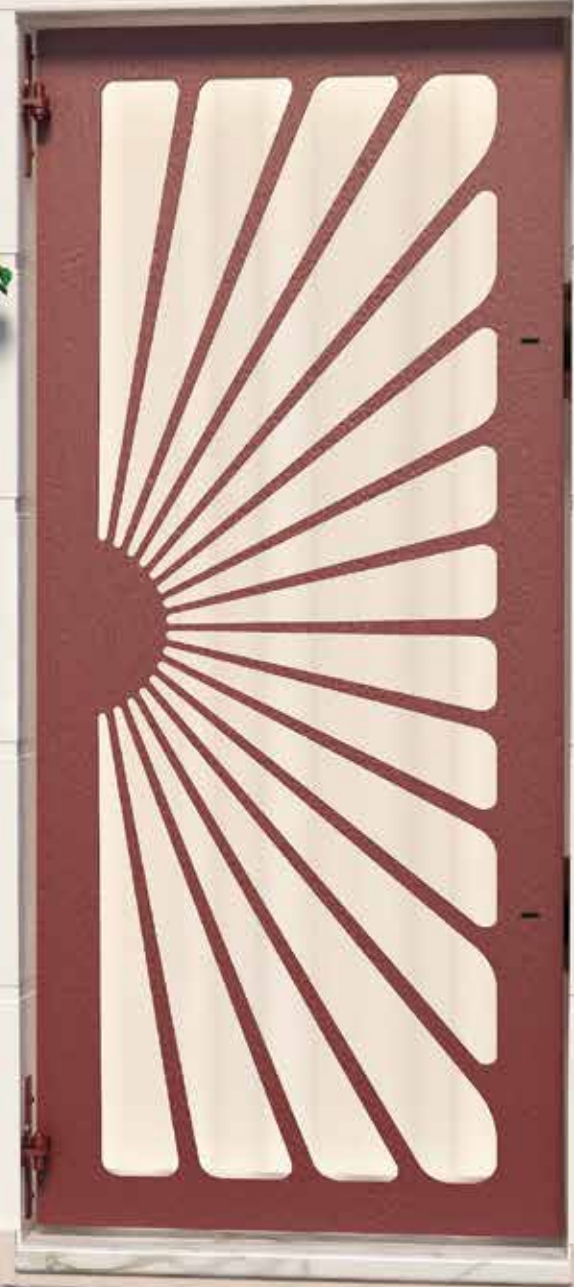

ART. 215

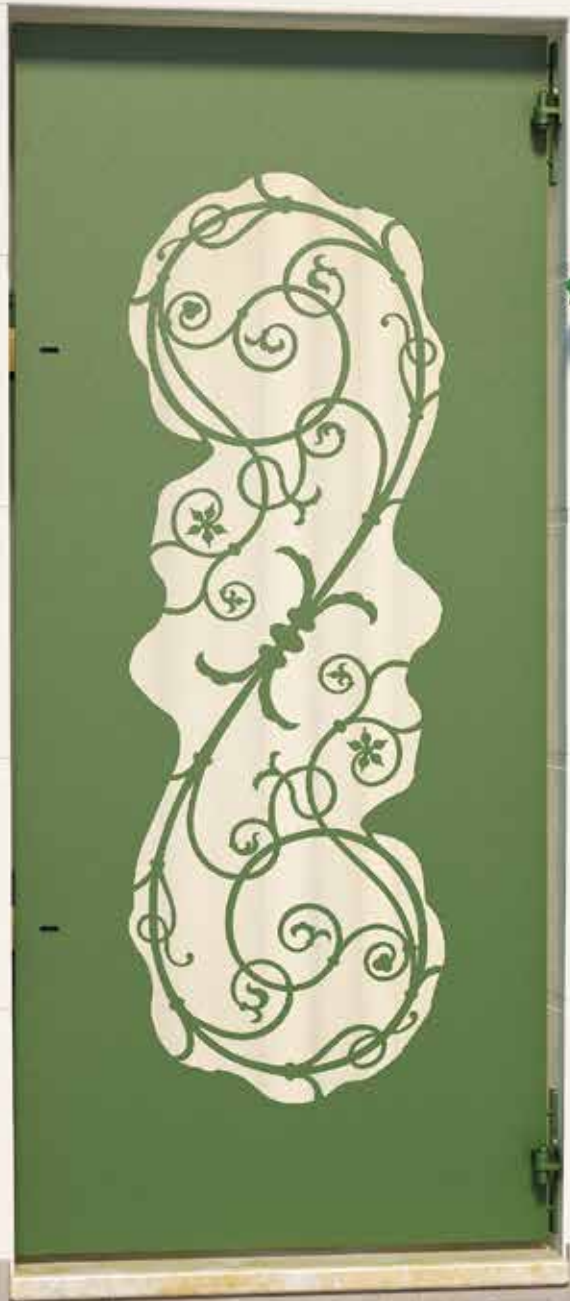

ART. 220



ART. 225



ART. M1500



ART. M1505

ART. M1510



ART. M1515





ART. M1520

ART. M1525

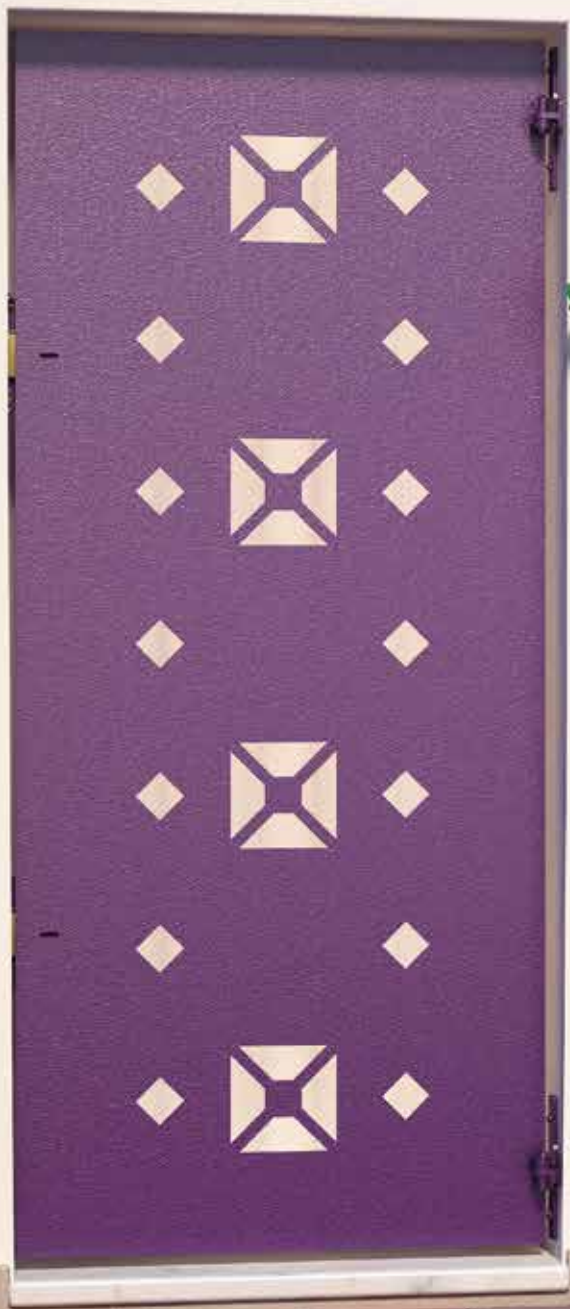

ART. M1530

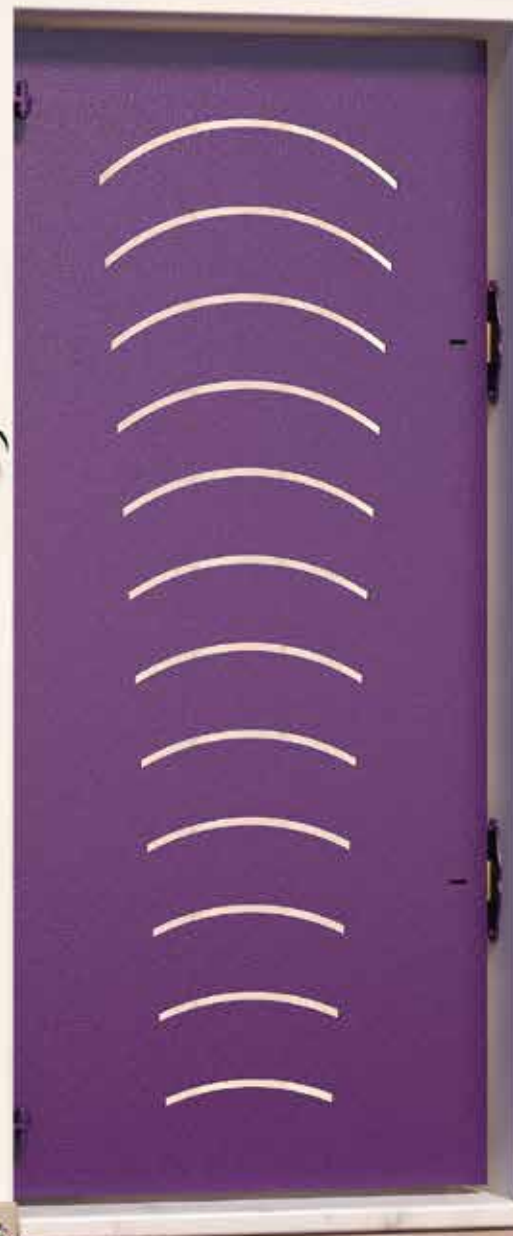

ART. M1535

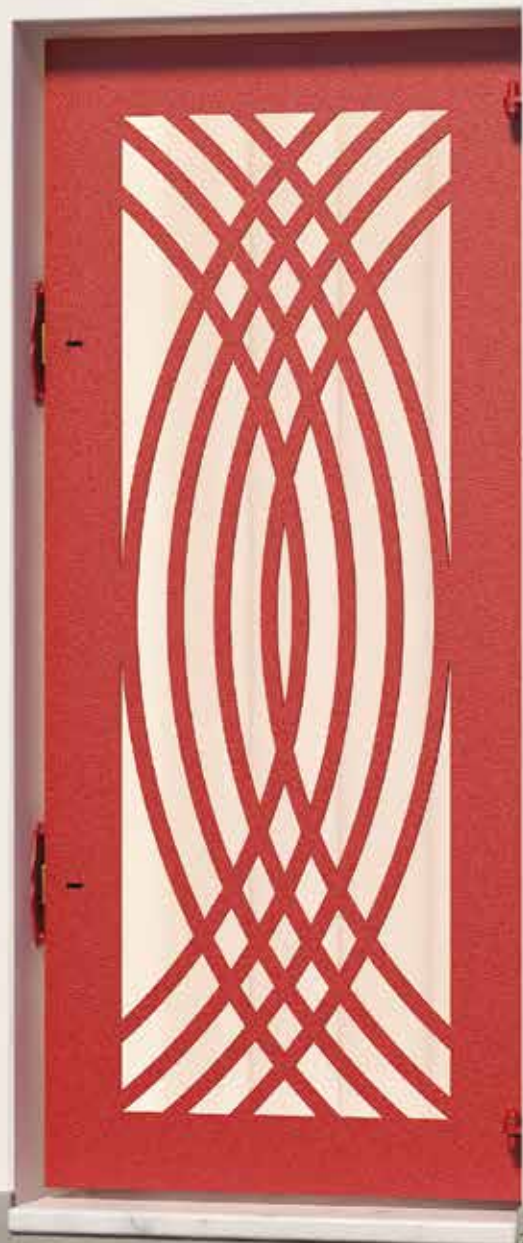

ART. M1540



ART. M1545

ART. M1550

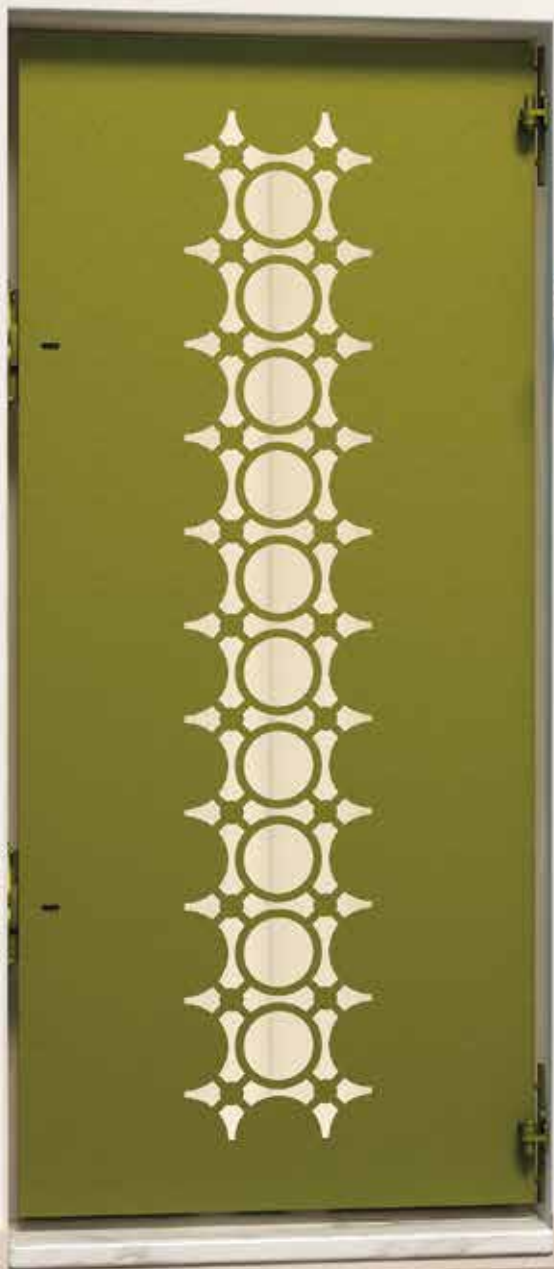

ART. M1555



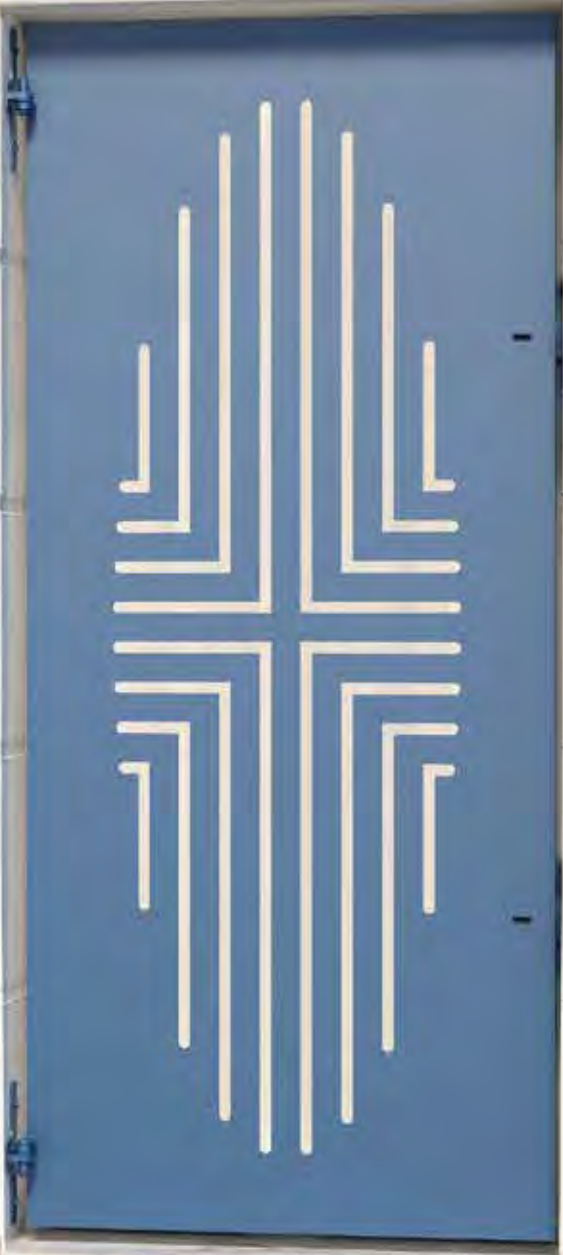

ART. M1560

ART. M1565

ART. M1570



ART. M1575

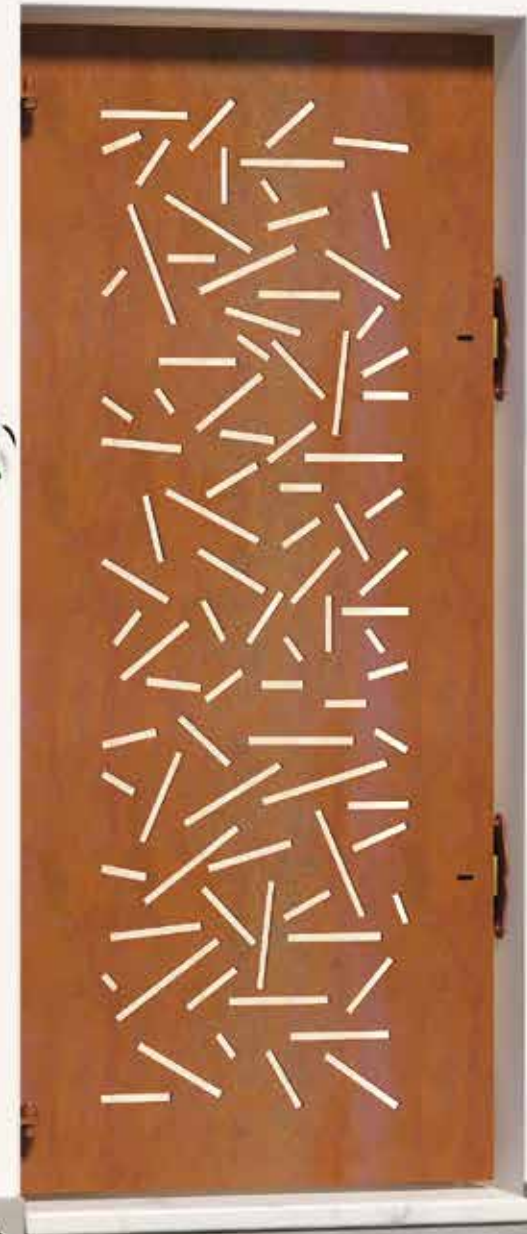

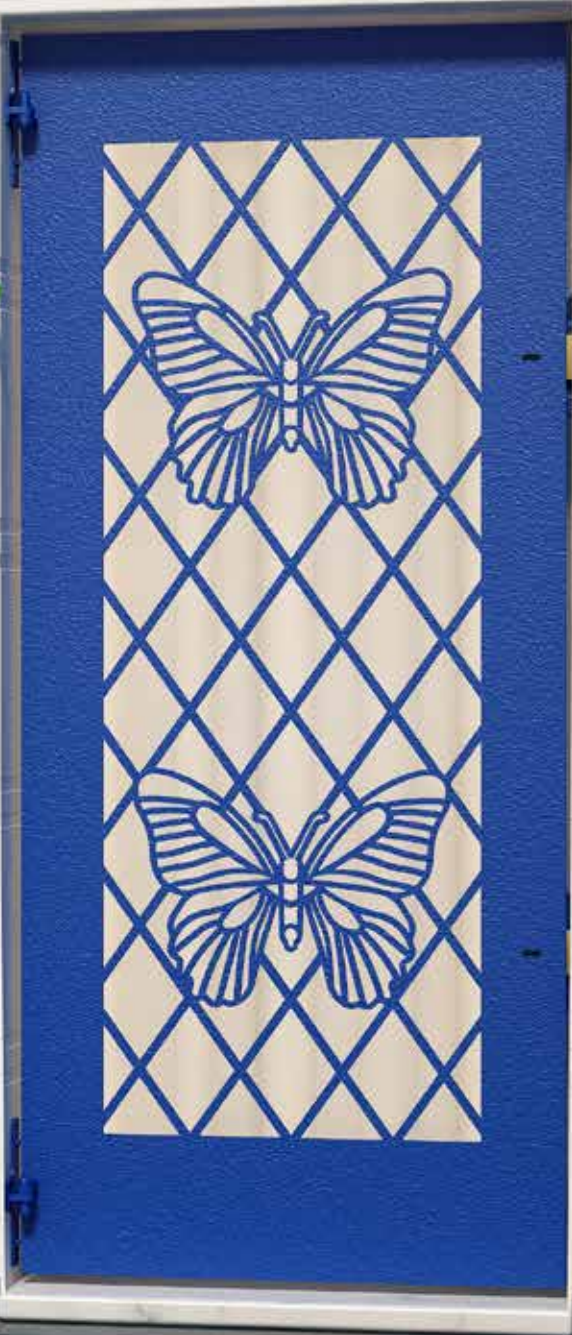
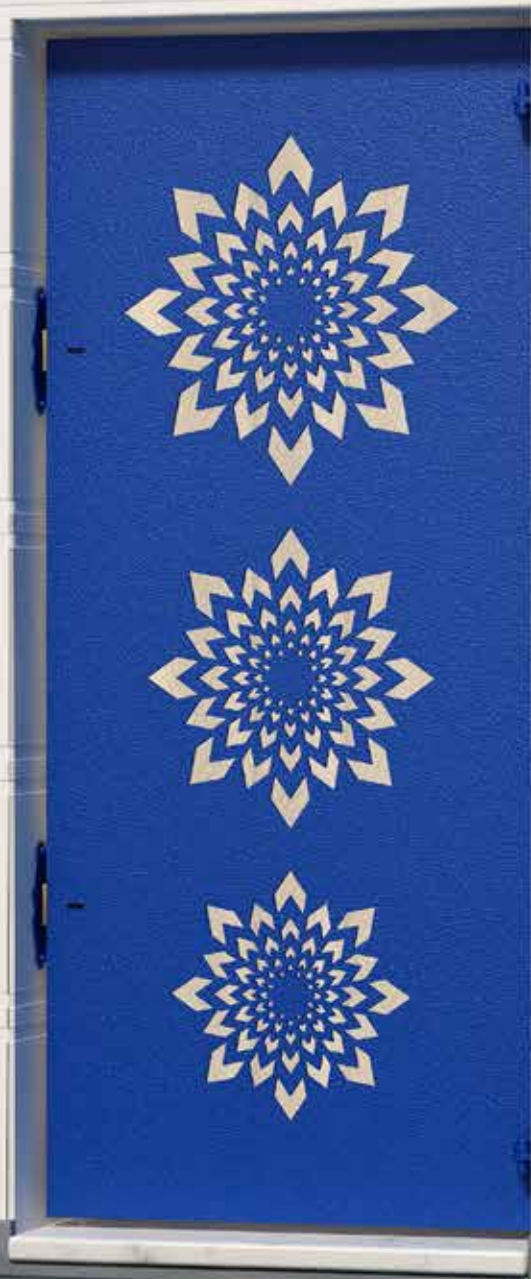

ART. M1580

ART. M1585

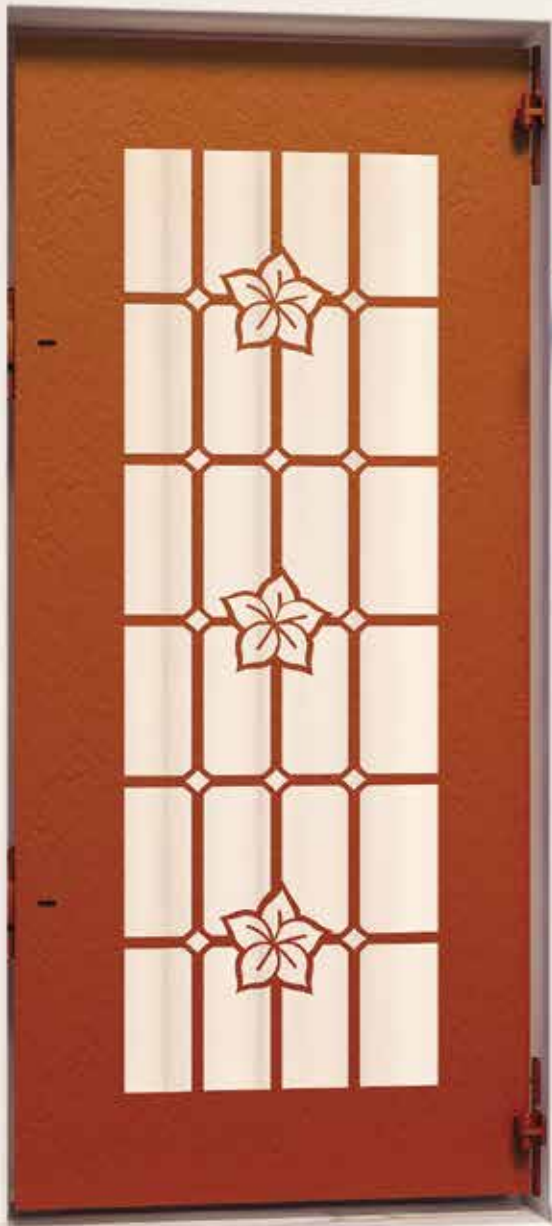

ART. M1590

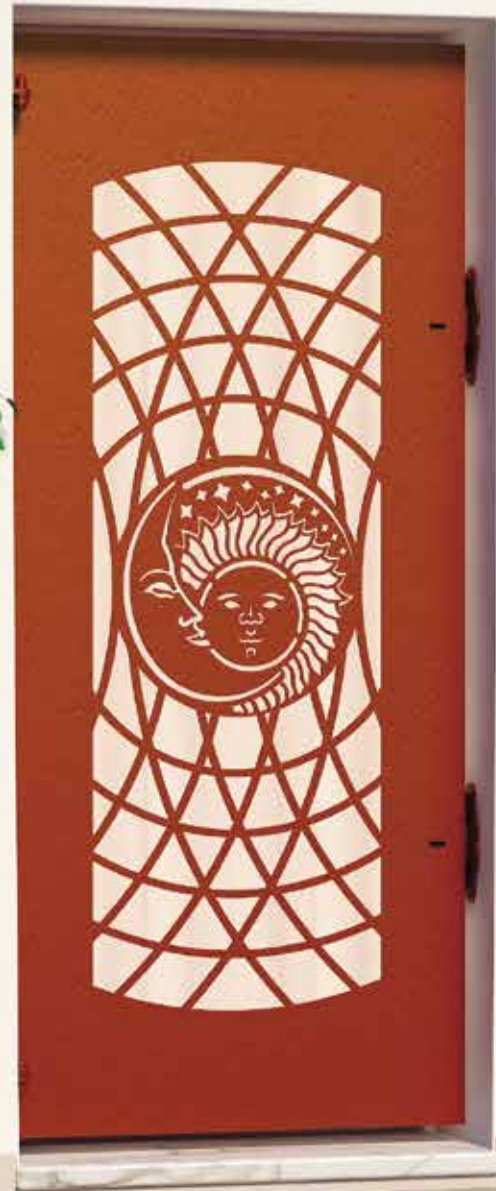

ART. M1595

ART. M1600



ART. M1605

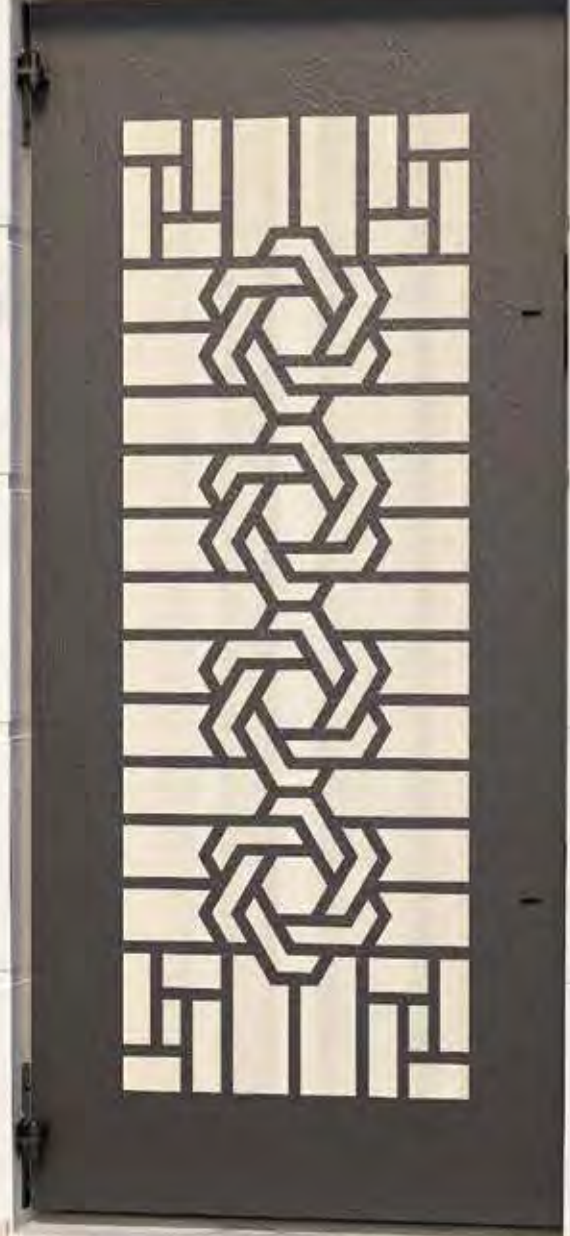

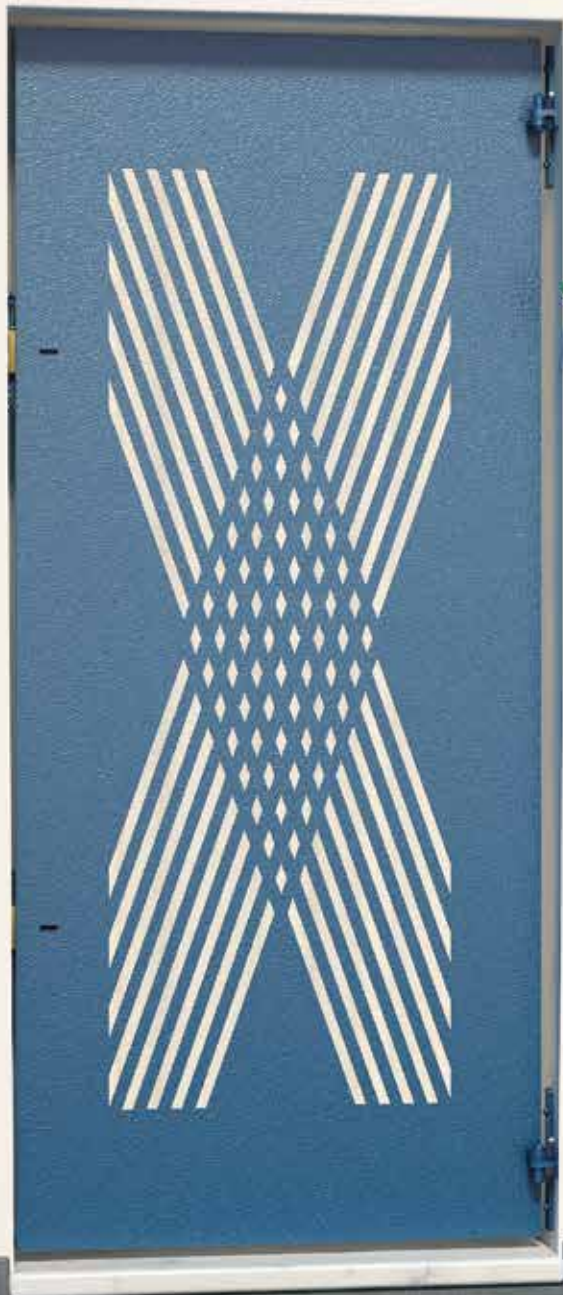

ART. M1615



ART. M1620



MARCO REGISTRATO
RIPRODUZIONE VIETATA

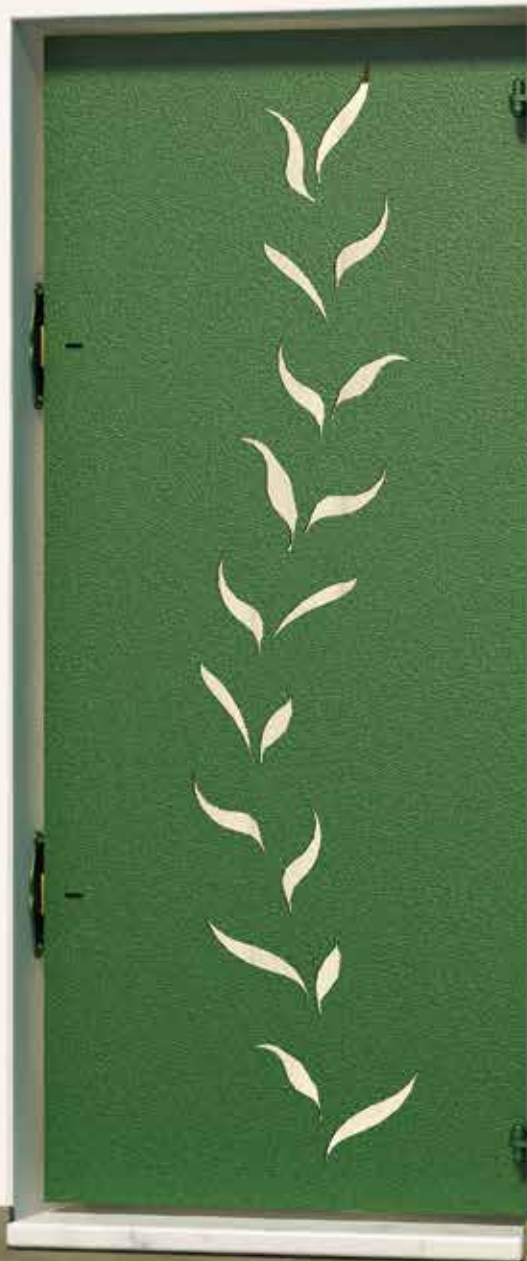

ART. M1625



ART. M1630

ART. M1635

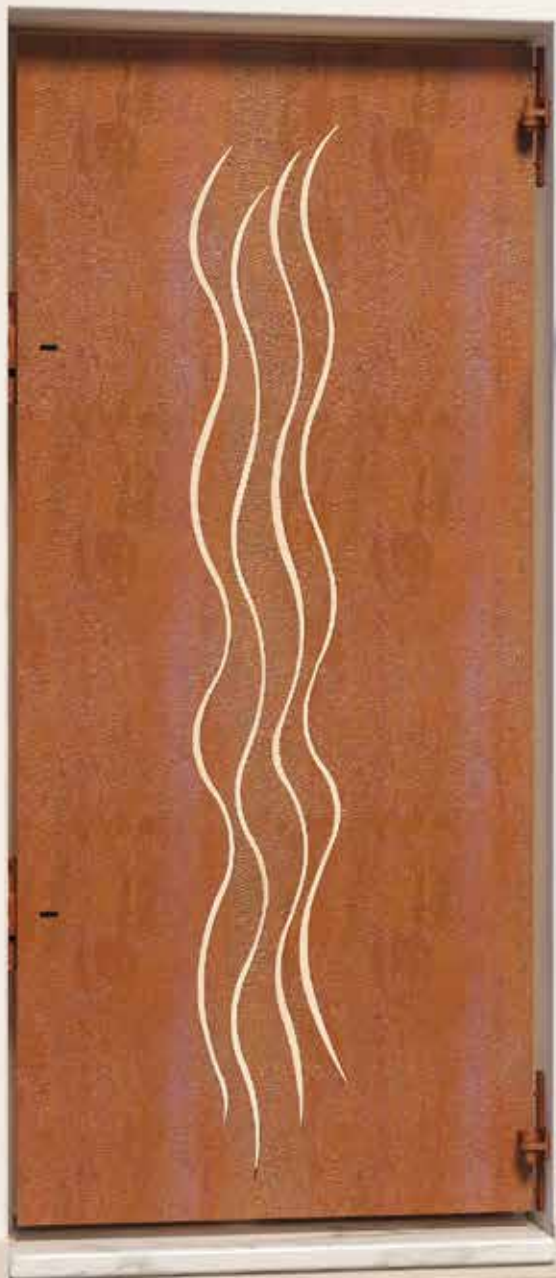

ART. M1640



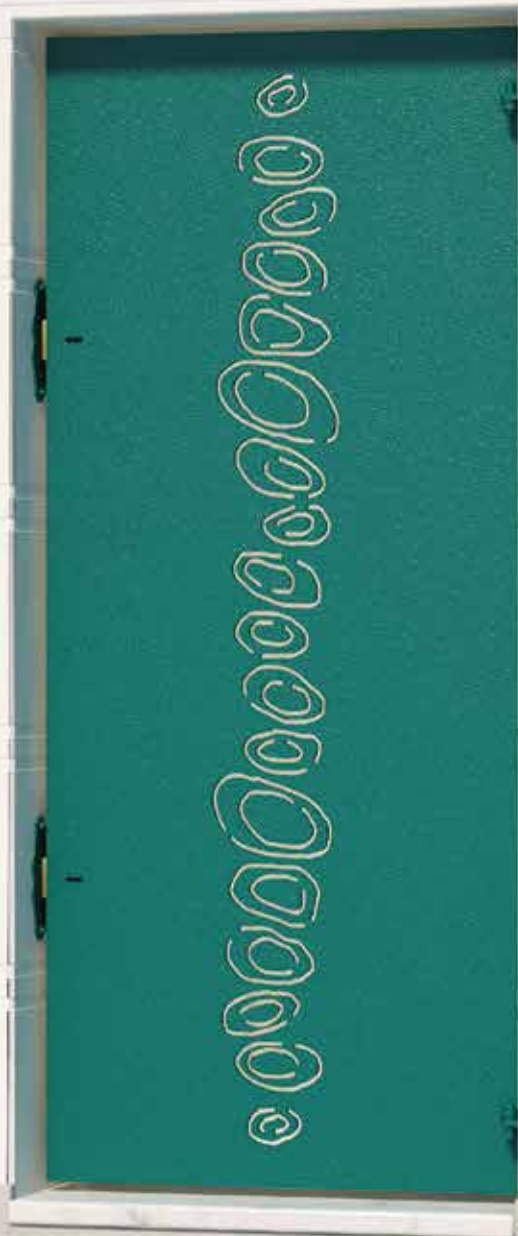

ART. M1645



ART. M1650



SCALE E POGGIOLI

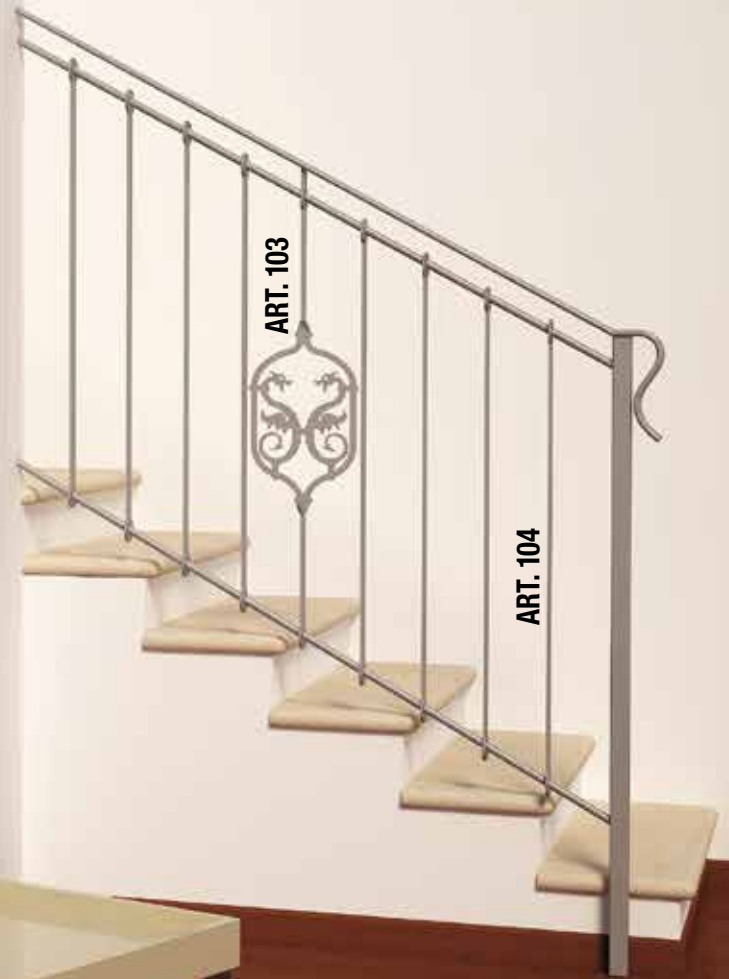



ART. 123

ART. 124



MARCO REGISTRATO
RIPRODUZIONE VIETATA



ART. 143

ART. 144

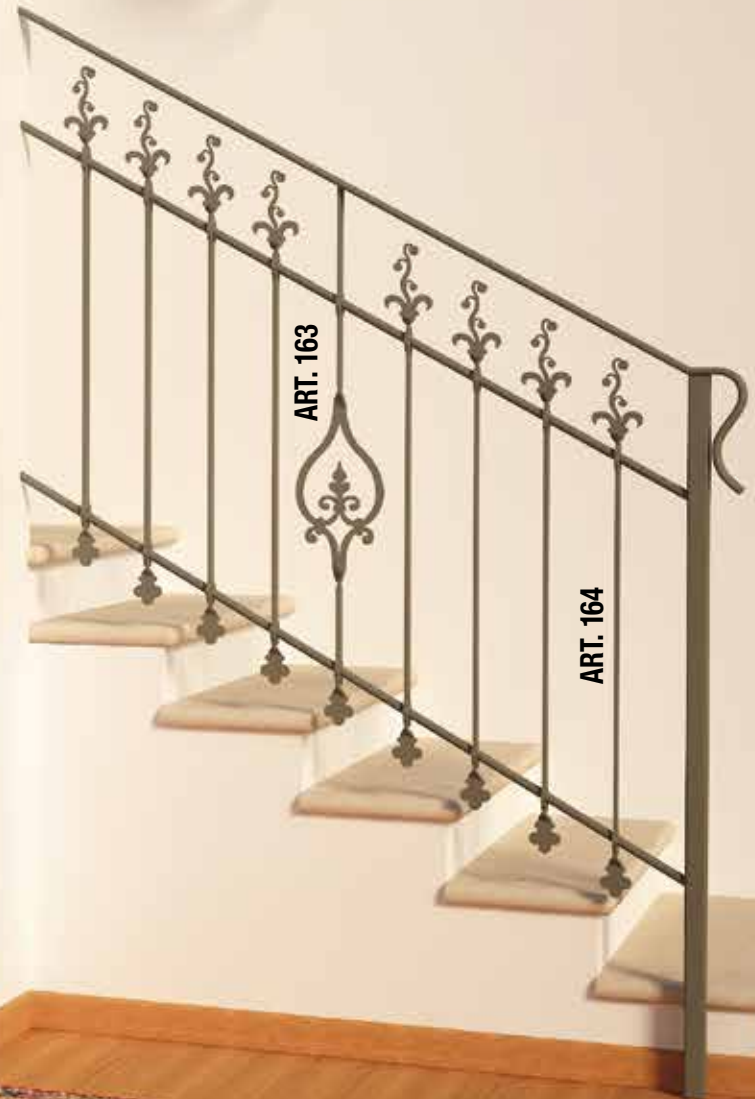

ART. 163

ART. 164





ART. 175



ART. 181

ART. 180



MARCHIO REGISTRATO
RIPRODUZIONE VIETATA



ART. 183

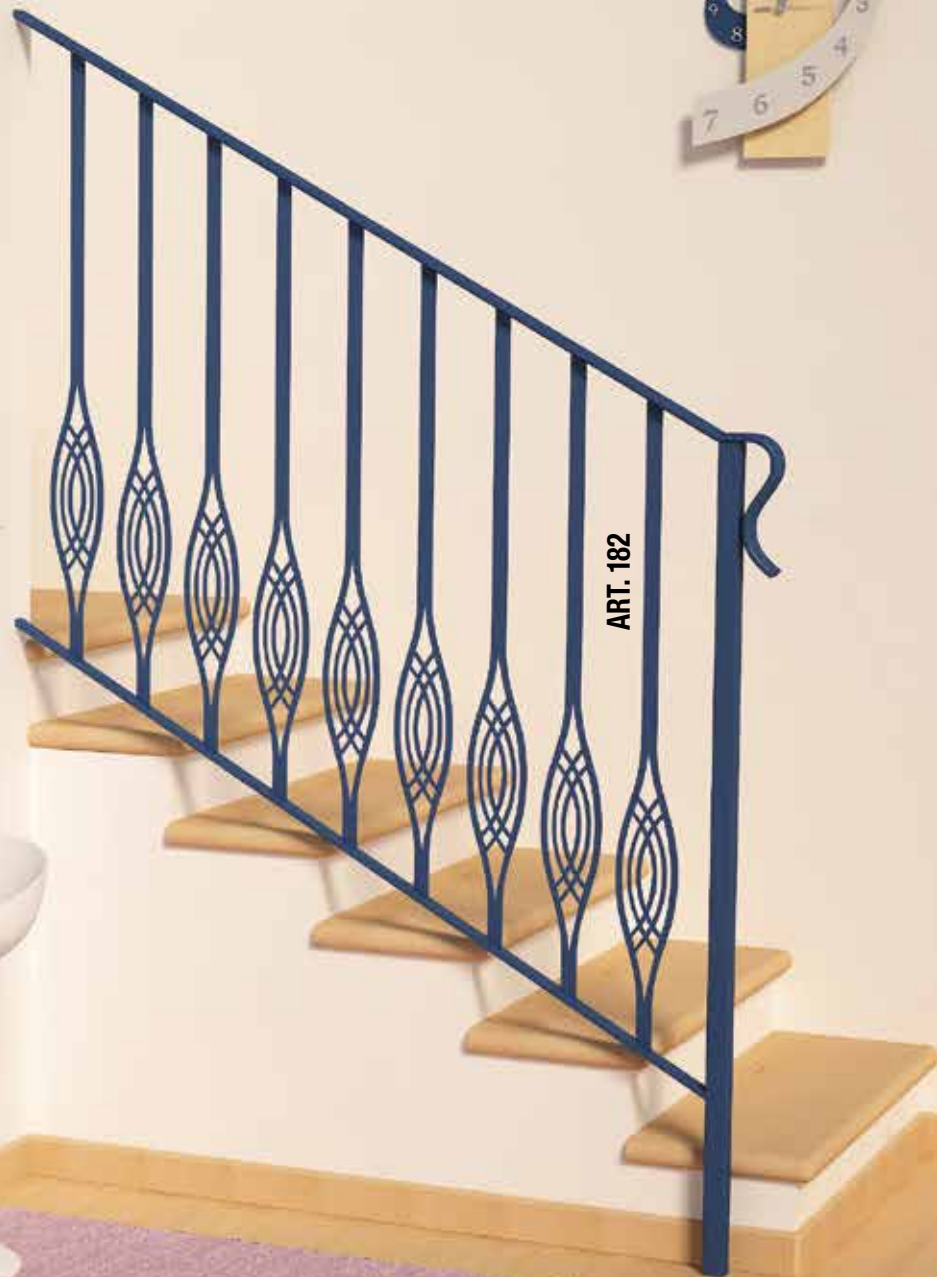

ART. 182





ART. 178



MARCO REGISTRATO
RIPRODUZIONE VIETATA



ART. AM 1015



ART. AM 1025

ART. AM 1026



ART. AM 1105



ART. AM 1145

ART. AM 1146



ART. AM 1185



ART. AM 1235



ART. AM 1325



ART. AM 1435



MARCO REGISTRATO
RIPRODUZIONE VIETATA



ART. AM 1655

ART. AM 1656



ART. AM 1665



ART. AM 1675



ART. AM 1686

ART. AM 1685
PORTAFIORI

ART. AM 1685



MARCHIO REGISTRATO
RIPRODUZIONE VIETATA



**ART. AM 1695
PORTAFIORI**

ART. AM 1695



**ART. AM 1705
PORTAFIORI**



ART. AM 1705



MARCO REGISTRATO
RIPRODUZIONE VIETATA





CANCELLI E RECINZIONI



MARCO REGISTRATO
RIPRODUZIONE VIETATA



ART. 230

ART. 231

ART. 232



ART. 241

ART. 240

ART. 243

ART. 242



ART. 250

ART. 251

ART. 252



ART. 260

ART. 261

ART. 263

ART. 262



MARCHIO REGISTRATO
RIPRODUZIONE VIETATA



ART. 271

ART. 270

ART. 273

ART. 272



ART. 282

ART. 280

ART. 281



ART. 292

ART. 293

ART. 290

ART. 291



ART. 300

ART. 301

ART. 302



ART. 310

ART. 311

ART. 313

ART. 312



ART. 320

ART. 321

ART. 322



ART. AM 1012

ART. AM 1010

ART. AM 1011



ART. AM 1020

ART. AM 1021



ART. AM 1032

ART. AM 1030

ART. AM 1031



ART. AM 1040

ART. AM 1041

ART. AM 1042



ART. AM 1052

ART. AM 1051

ART. AM 1050



ART. AM 1062

ART. AM 1061

ART. AM 1060



ART. AM 1072

ART. AM 1070

ART. AM 1071



ART. AM 1082

ART. AM 1080

ART. AM 1081



ART. AM 1090

ART. AM 1091

ART. AM 1092



ART. AM 1100

ART. AM 1101



ART. AM 1110

ART. AM 1111

ART. AM 1112



ART. AM 1120

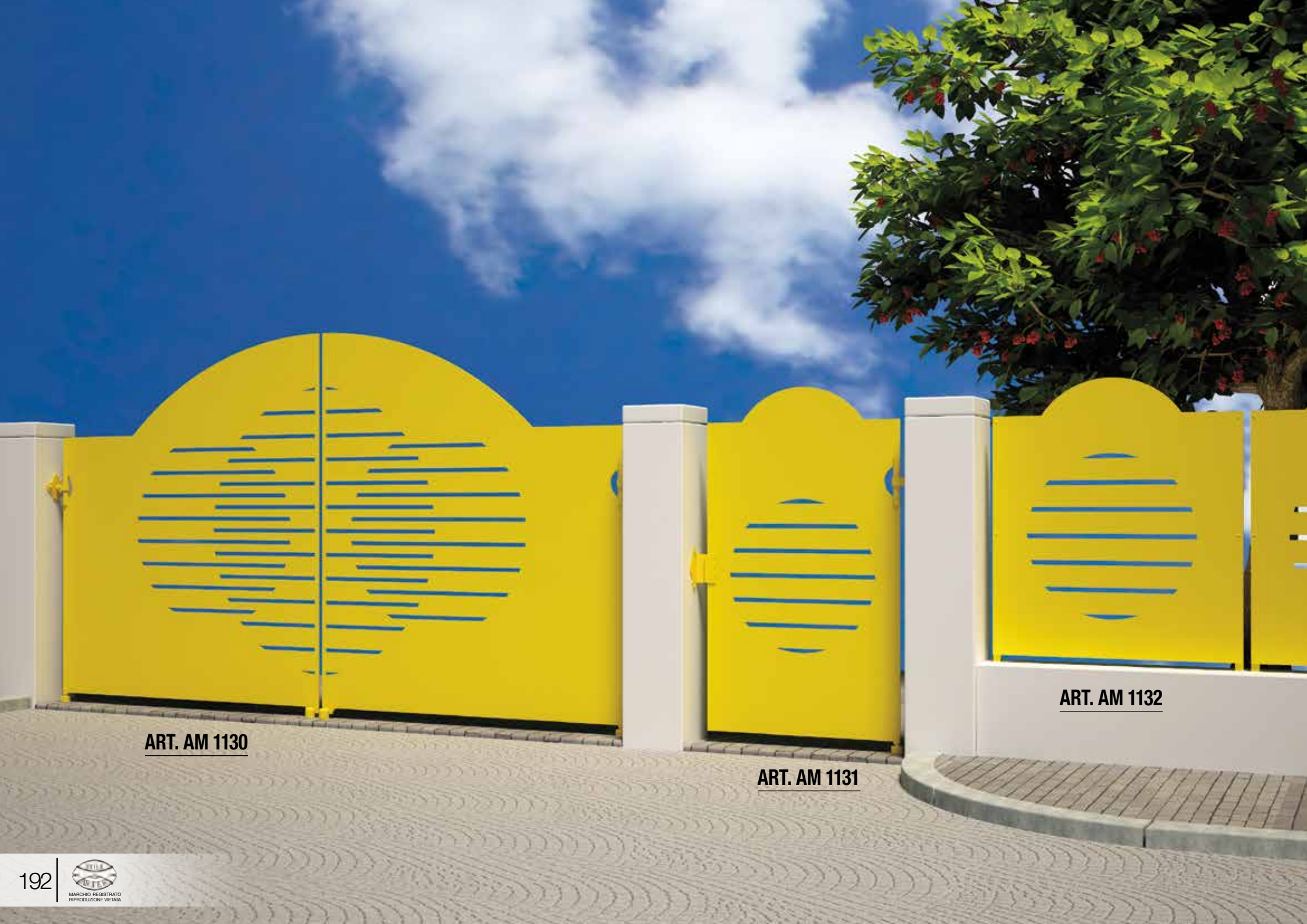

ART. AM 1130

ART. AM 1131

ART. AM 1132

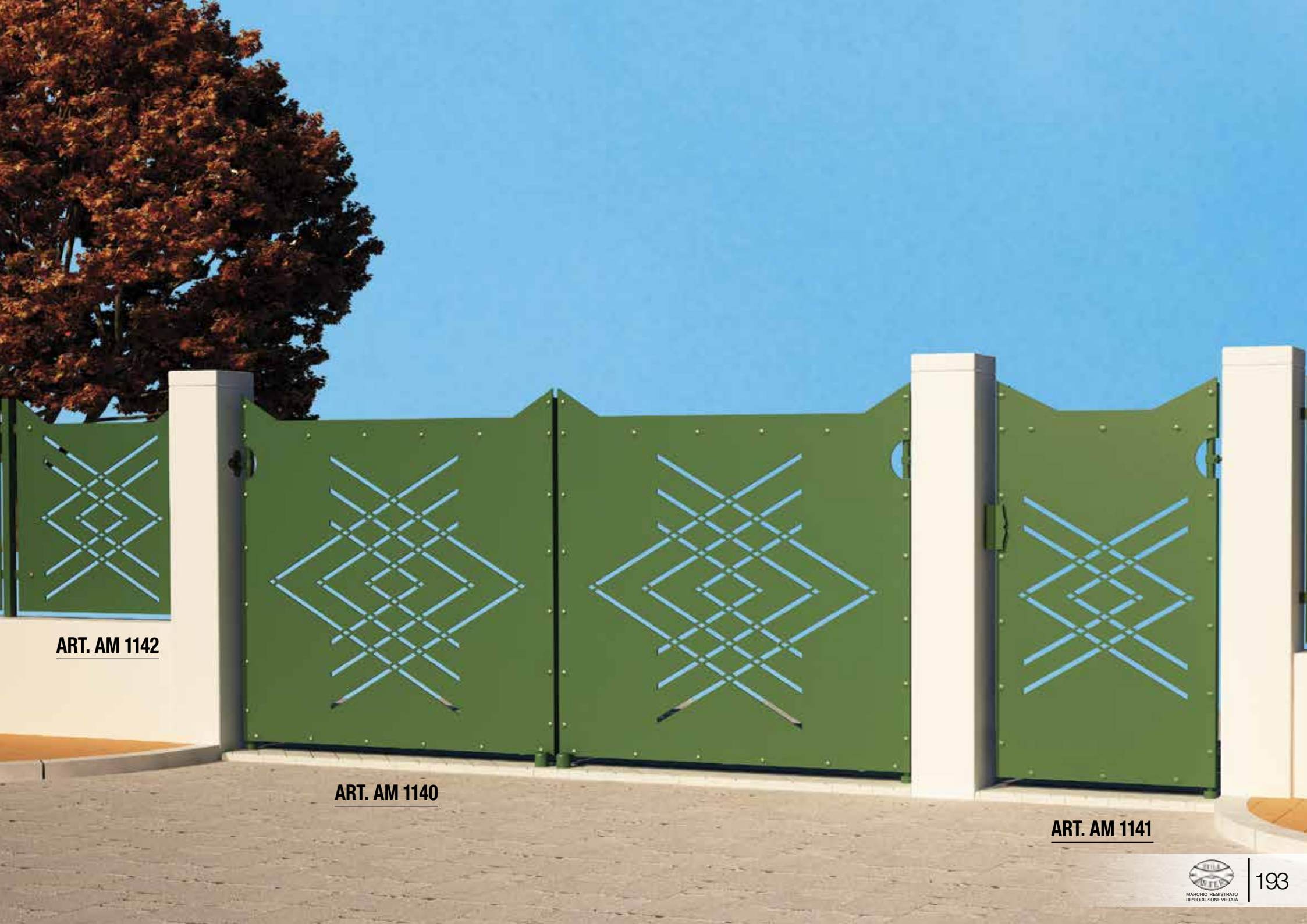

ART. AM 1142

ART. AM 1140

ART. AM 1141

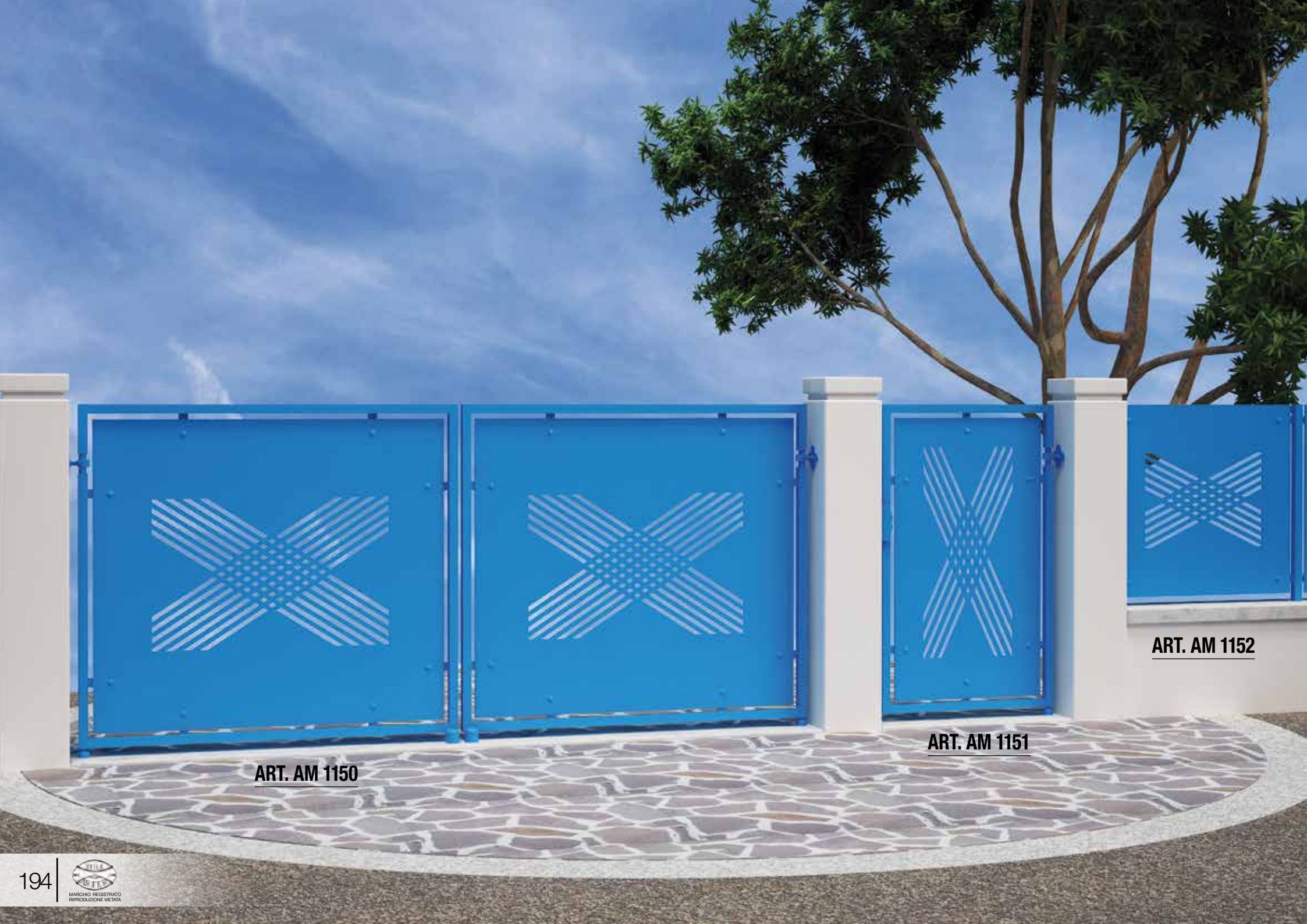

ART. AM 1150

ART. AM 1151

ART. AM 1152



ART. AM 1160

ART. AM 1161



MARCHIO REGISTRATO
RIPRODUZIONE VIETATA



ART. AM 1172

ART. AM 1170

ART. AM 1171



ART. AM 1180



ART. AM 1181



ART. AM 1182



ART. AM 1192

ART. AM 1190

ART. AM 1191



ART. AM 1200

ART. AM 1201

ART. AM 1202



ART. AM 1212

ART. AM 1211

ART. AM 1210



ART. AM 1220

ART. AM 1221

ART. AM 1222



MARCO REGISTRATO
RIPRODUZIONE VIETATA



ART. AM 1230

ART. AM 1231



ART. AM 1240

ART. AM 1241

ART. AM 1242

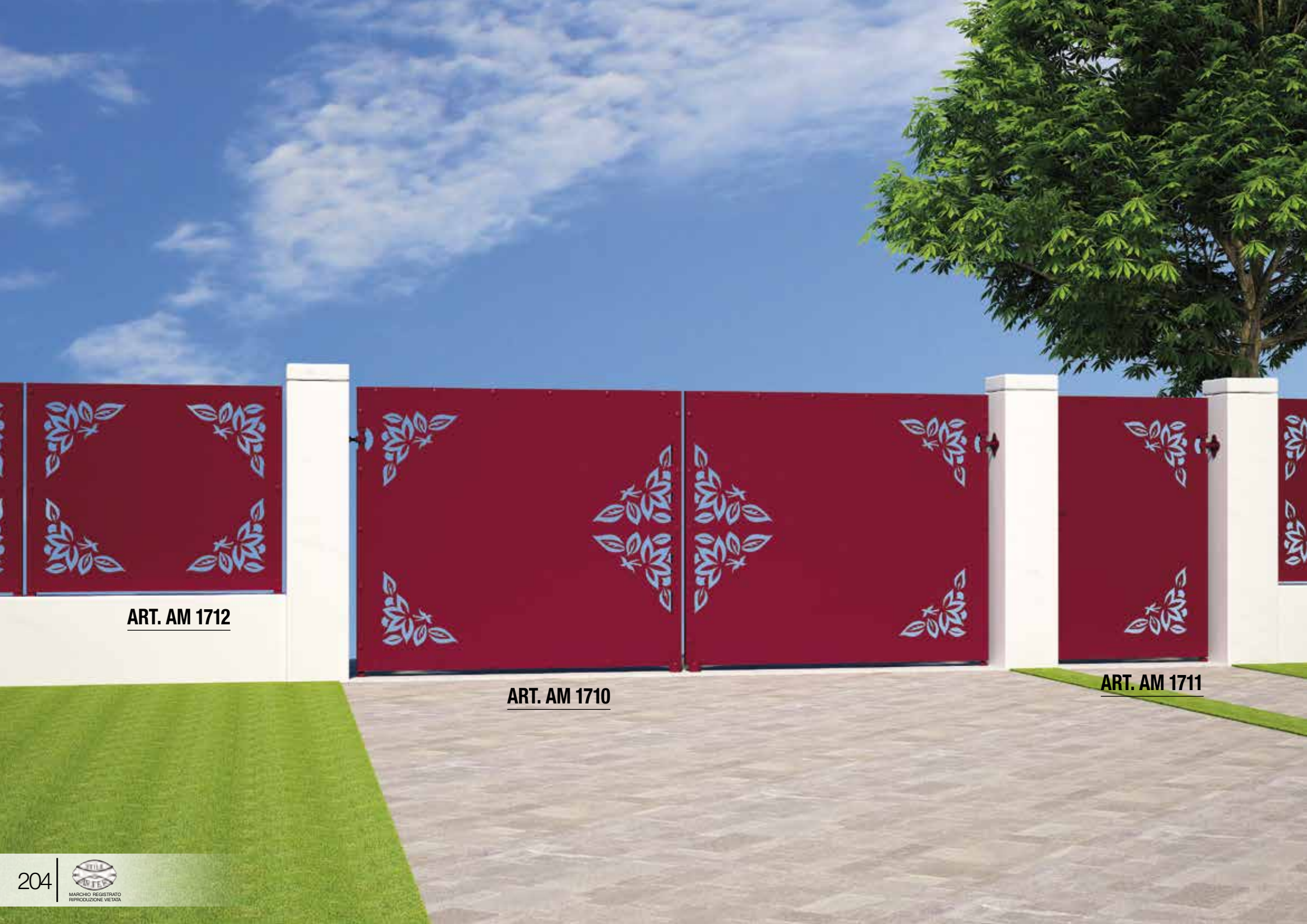

ART. AM 1712

ART. AM 1710

ART. AM 1711



ART. AM 1260

ART. AM 1261

ART. AM 1262



ART. AM 1270

ART. AM 1271

ART. AM 1272



ART. AM 1280

ART. AM 1281

ART. AM 1282



ART. AM 1290

ART. AM 1291

ART. AM 1292



ART. AM 1300

ART. AM 1301

ART. AM 1302



ART. AM 1310

ART. AM 1311

ART. AM 1312



ART. AM 1322

ART. AM 1321

ART. AM 1320



MARCO REGISTRATO
RIPRODUZIONE VIETATA



ART. AM 1332

ART. AM 1331

ART. AM 1330

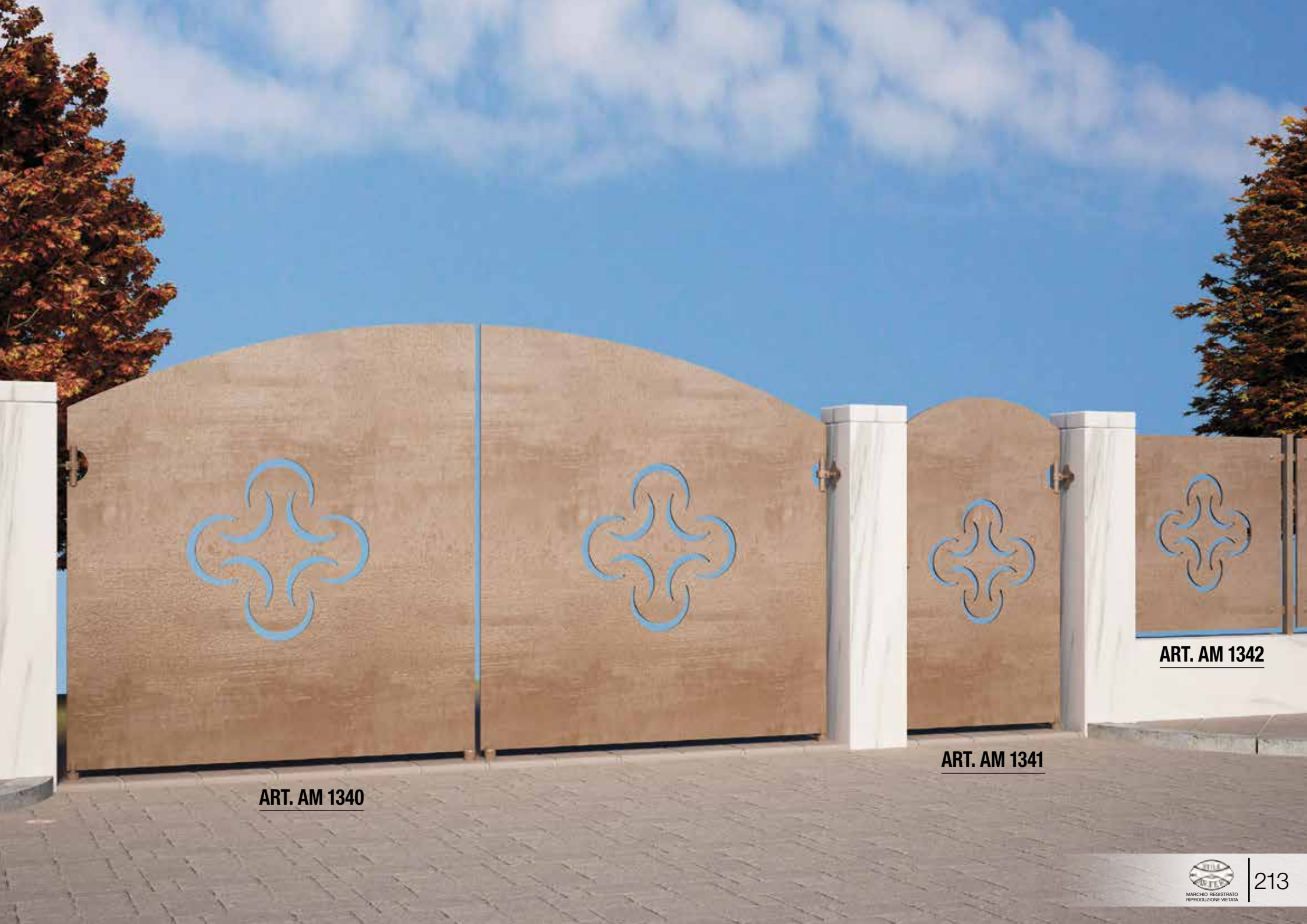

ART. AM 1340

ART. AM 1341

ART. AM 1342



ART. AM 1350

ART. AM 1351

ART. AM 1352

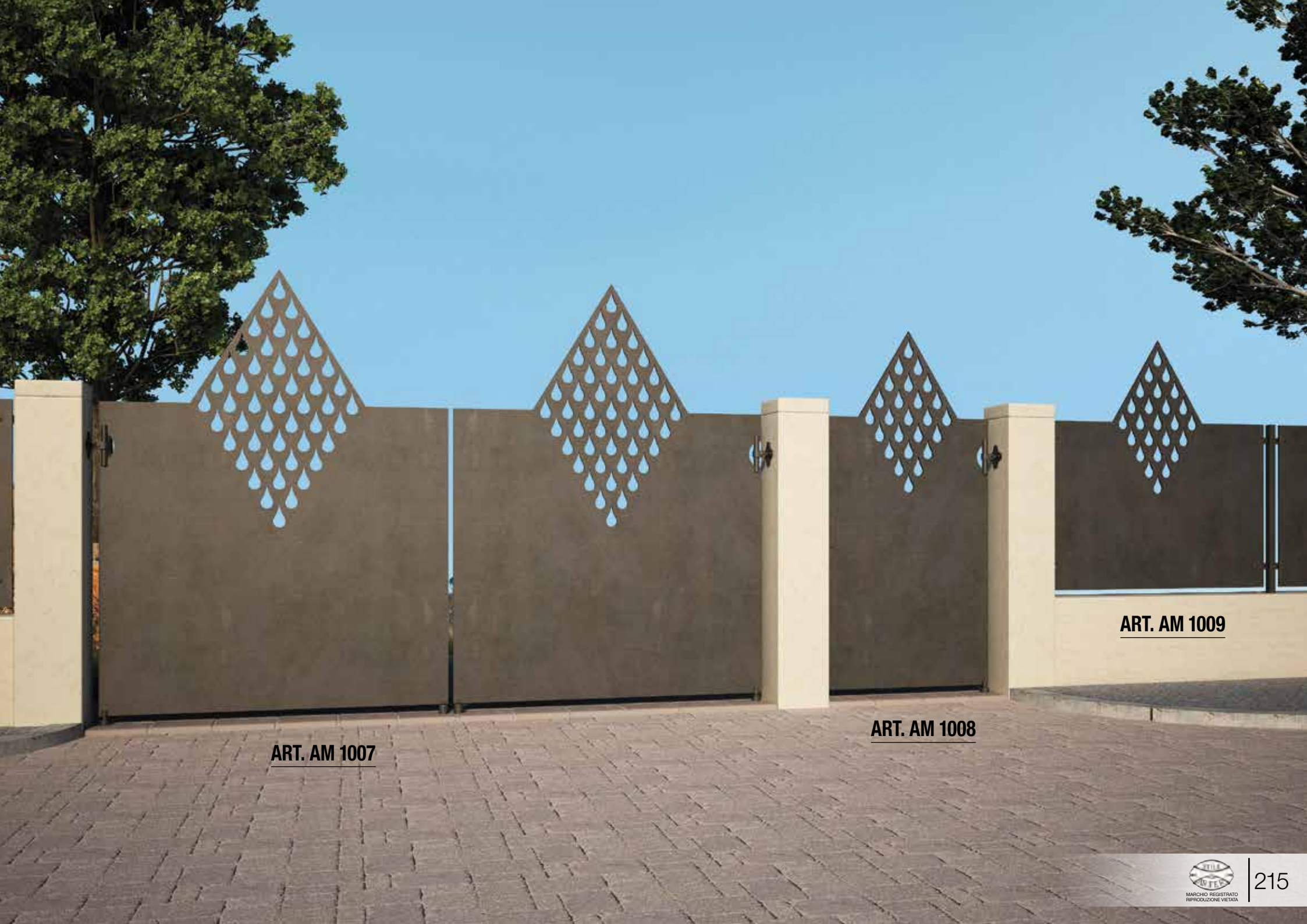

ART. AM 1007

ART. AM 1008

ART. AM 1009



ART. AM 1017

ART. AM 1018

ART. AM 1019



ART. AM 1022

ART. AM 1023

ART. AM 1024



ART. AM 1035

ART. AM 1036

ART. AM 1037



ART. AM 1137

ART. AM 1138



ART. AM 1319

ART. AM 1317

ART. AM 1318



ART. AM 1427

ART. AM 1428



ART. AM 1437



ART. AM 1438



ART. AM 1439



ART. AM 1455



MARCHIO REGISTRATO
RIPRODUZIONE VIETATA

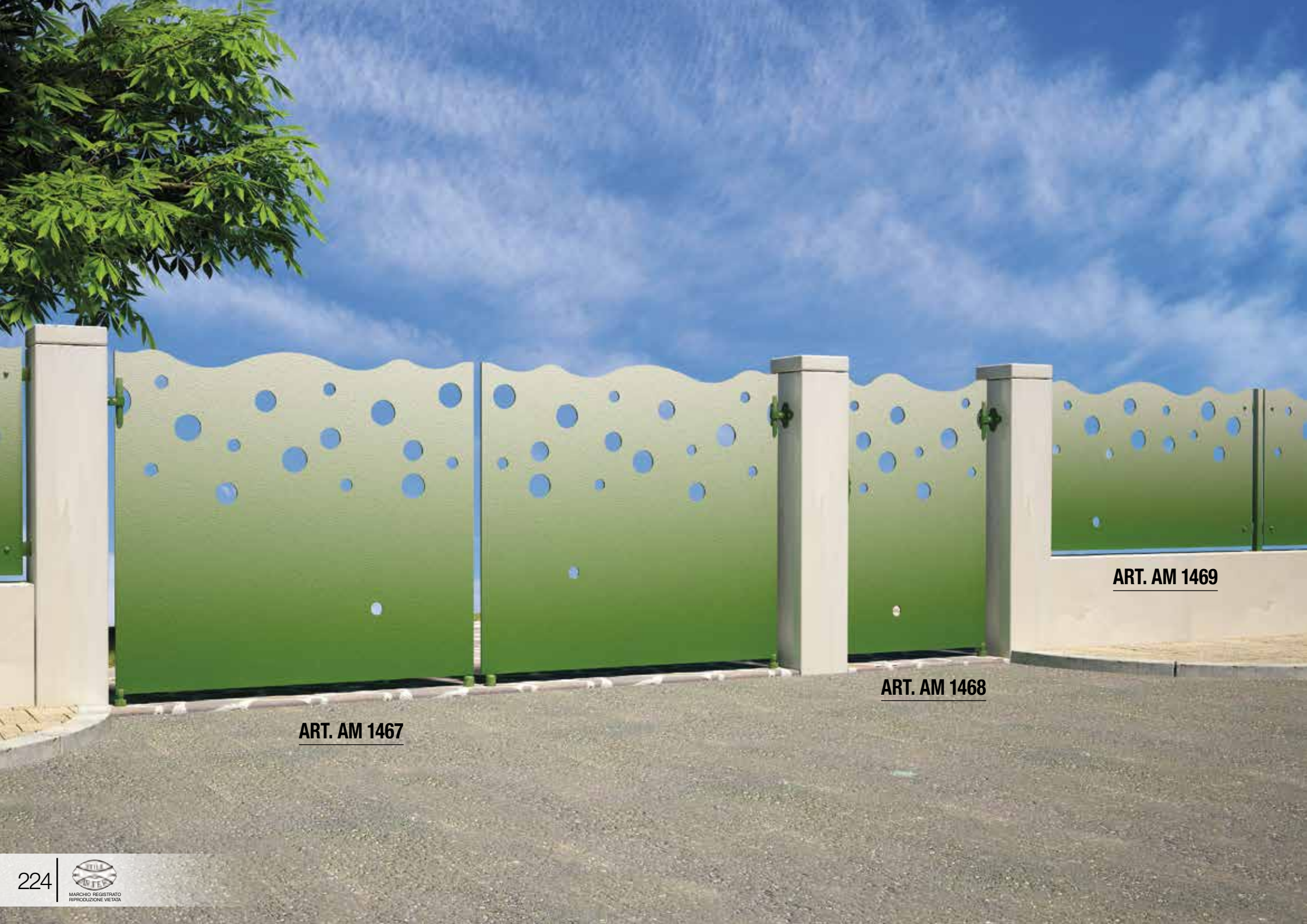

ART. AM 1467

ART. AM 1468

ART. AM 1469



ART. AM 1722

ART. AM 1721

ART. AM 1720



MARCHIO REGISTRATO
RIPRODUZIONE VIETATA



ART. AM 1730

ART. AM 1731

ART. AM 1732



ART. AM 1740

ART. AM 1741

ART. AM 1742



ART. AM 1750



ART. AM 1751



ART. AM 1752



ART. AM 1760

ART. AM 1761

ART. AM 1762





OPERE REALIZZATE



MARCHIO REGISTRATO
RIPRODUZIONE VIETATA



FOTO 1



FOTO 2



FOTO 3



FOTO 4



FOTO 5



FOTO 6



FOTO 1



FOTO 2



FOTO 3



FOTO 4



FOTO 5



FOTO 6



MARCO REGISTRATO
RIPRODUZIONE VIETATA



FOTO 1



FOTO 2



FOTO 3



FOTO 4



FOTO 5



FOTO 6



FOTO 7



FOTO 1



FOTO 2



FOTO 3



FOTO 4



FOTO 5



FOTO 6



MARCO REGISTRATO
RIPRODUZIONE VIETATA



FOTO 1



FOTO 2



FOTO 3



FOTO 4



FOTO 5



FOTO 6



FOTO 7



FOTO 8

È DISPONIBILE LA APP AR-FER!

VESTITE LA VOSTRA CASA IN TEMPO REALE. LA PRIMA APP DEDICATA AI LAVORI DECORATIVI IN FERRO

IS AVAILABLE THE APP AR-FER!

DRESSED YOUR HOME IN REAL-TIME. THE FIRST DEDICATED APP TO THE DECORATIVE IRON WORK



1. Cliccate sul pulsante foto
Click on the photo button



2. Si apre questa videata
This screen appears



3. Scegliete le inferriate esterne
Choose the outside grate

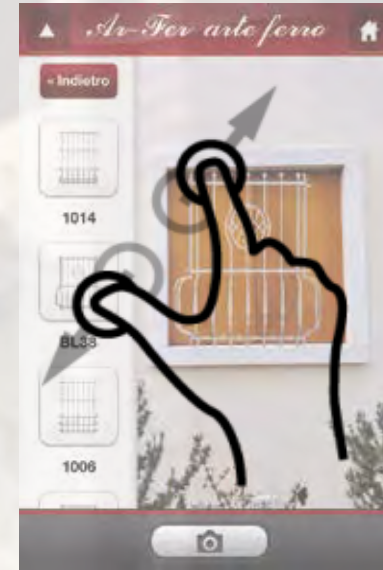

4. Ora selezionate l'inferriata che vi piace e questa apparirà nella videata. Usate il movimento delle dita, qui a lato indicato, per adattare l'immagine dell'inferriata alla vostra finestra!

Now, select the grate you like and this will appear on the screen. Use the movement of the fingers, next to shown, to fit the image of the grate to your window.



5. Usate lo stesso procedimento anche per i Cancelli e i Portoncini. Potete salvare la foto e stamparla dal vostro computer!
Used the same procedure for the Gates and Doors. You can save the picture and print it from your computer.

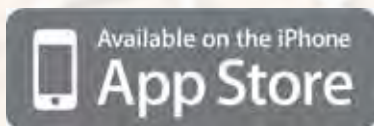

Cerca Ar-Fer sullo APP STORE della Apple
Compatibile con Iphone ed Ipad tutte le versioni
*Find Ar-Fer on the Apple APP STORE
Compatible with Iphone and Ipad all versions*

PER OFFERTE IMMEDIATE RICHIEDETE LE CREDENZIALI DI ACCESSO AL NOSTRO LISTINO ON-LINE!

REQUEST CREDENTIALS FOR ACCESS TO OUR ONLINE PRICE LIST TO GET OFFERS IMMEDIATELY!

The screenshot shows a web browser window displaying the website costopezzi.arfer.it/. The page features a navigation bar with the 'STILE ARFER Costo Pezzi' logo and menu items: 'Nuovo', 'Offerte', 'Clienti', 'Impostazioni', and 'Esci'. The main content area is a grid of 16 decorative ironwork categories, each with a representative image and a label:

- VERTICALI E LANCE
- MONTANTI RINGHIERE
- CURVE LAMINATE
- CURVE PANTOGRAFATE
- CANCELLO PEDONALE
- CANCELLO CARRAIO
- INFERRIATA INTERNA
- INFERRIATA SPORGENTE
- CANCELLETTO PORTA
- ROSONI
- BATTENTI
- BATTENTI PANTOGRAFATI
- TRASVERSALI
- FASCE

<http://costopezzi.arfer.it>



Ar-Fer arte ferro srl

ALMANACCO TECNICO

Iron
uno

**CUT
DESIGN**

EDIZIONE GENNAIO 2015

**LE DECORAZIONI PER LE MIGLIORI OPERE
IN FERRO PER RINGHIERE**

*DECORATIONS FOR
THE BEST WORKS IN IRON FOR RAILINGS*

INDICE *INDEX*

VERTICALI E TERMINALI DECORATIVI PER RECINZIONI E CANCELLI <i>DECORATIVE STAKES FOR FENCES AND GATES</i>	242	RICCIOLI DECORATIVI, FASCETTE, COPRIPILASTRI, RIBATTINI <i>DECORATIVE CURLS, CLIPS, POST TOPS, RIVETS</i>	282
PANNELLI DECORATIVI IN LAMIERA <i>DECORATIVE METAL SHEET</i>	254	LETTERE E NUMERI <i>LETTERS AND NUMBERS</i>	283
CURVE DECORATIVE PER CANCELLI <i>DECORATIVE GATE TOPS</i>	255	STAFFE DI FISSAGGIO DECORATIVE, ACCESSORI PER CANCELLI, RECINZIONI, CANCELLETTI PORTA <i>DECORATIVE BRACKET, ACCESSORIES FOR GATES, FENCES AND SECURITY GATES</i>	284
TERMINALI PER BATTENTI - TERMINALI PER MONTANTI <i>TERMINALS FOR GATES</i>	257	BARRE FORATE SU MISURA <i>HOLED BARS IN SPECIAL SIZE</i>	302
VERTICALI DECORATIVI PER INFERRIATE SPORGENTI ED INFERRIATE INTERNE <i>DECORATIVE STAKES FOR EXTERIOR AND INTERIOR GRATES</i>	258	PIATTI FORATI <i>IRON PLATE WITH HOLES</i>	303
VERTICALI DECORATIVI PER CANCELLETTI PORTA <i>DECORATIVE STAKES FOR SECURITY GATES</i>	262	PROFILI BATTUTI <i>WROUGHT PROFILES</i>	304
VERTICALI E PANNELLI DECORATIVI PER SCALE E BALCONI PROFILI E TERMINALI CORRIMANO <i>DECORATIVE STAKES AND METAL SHEET FOR STAIRCASES AND BALUSTRADES</i>	264	BORCHIE ORNAMENTALI IN TUBO <i>ORNAMENTAL TUBE STUDS</i>	305
FASCE DECORATIVE PANTOGRAFATE <i>SHEET METAL MOTIFS</i>	271	ELEMENTI DI ARREDO - ACCESSORI PER LEGNO <i>FURNISHING ELEMENTS - ACCESSORIES FOR WOOD</i>	306
ROSONI, STEMMI DECORATIVI <i>ROSETTES, DECORATIVE COAT-OF-ARMS</i>	278	INDICE ARTICOLI <i>PRODUCTS INDEX</i>	330

VERTICALI DECORATIVI PER RECINZIONI

DECORATIVE STAKES FOR FENCES



Tutte le decorazioni vengono eseguite anche con profili battuti. Per l'ordinazione del materiale fornire le misure dell'H1 e H2.

VERTICALI DECORATIVI PER RECINZIONI

DECORATIVE STAKES FOR FENCES

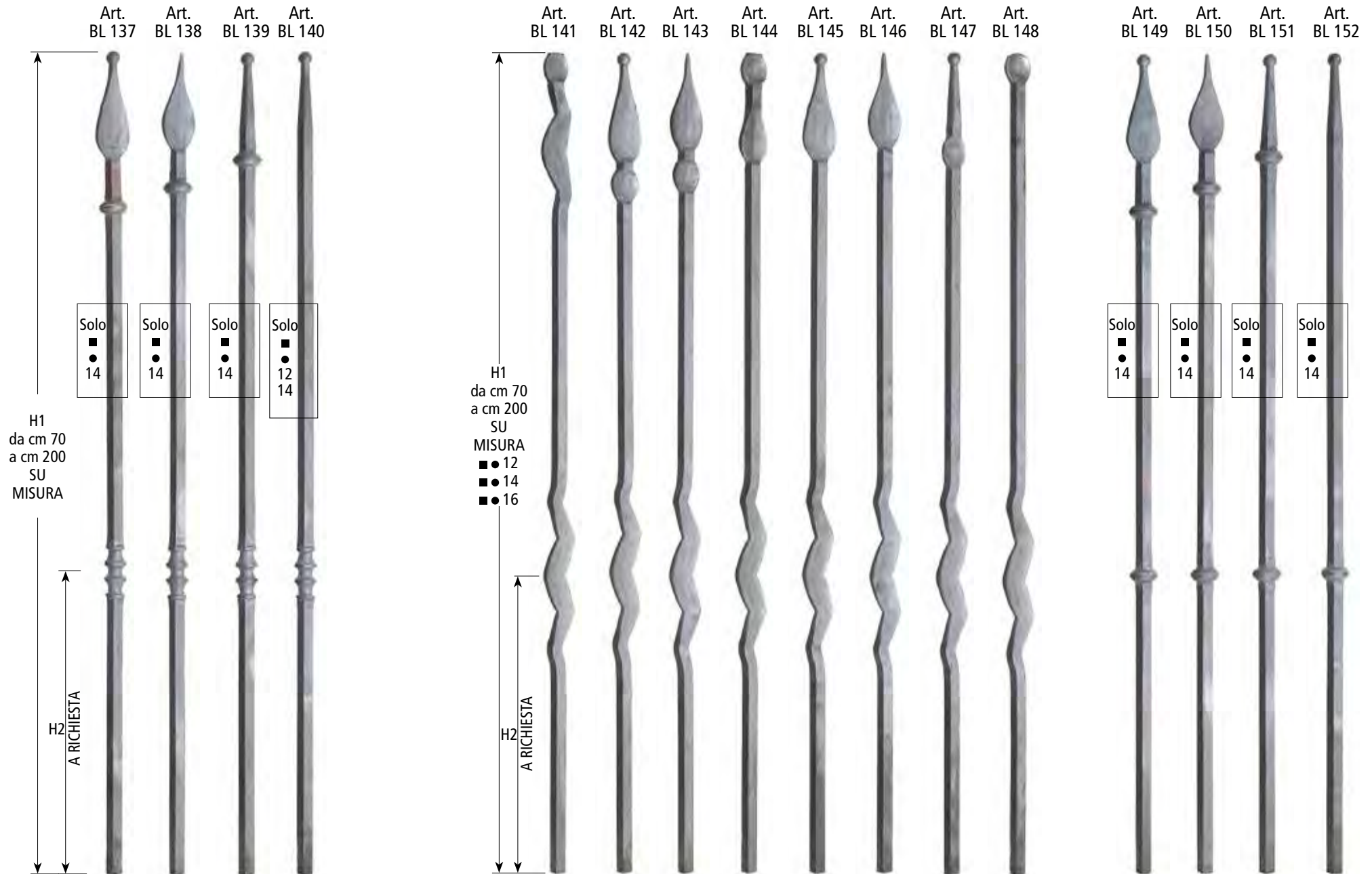

Tutte le decorazioni vengono eseguite anche con profili battuti. Per l'ordinazione del materiale fornire le misure dell'H1 e H2.

VERTICALI DECORATIVI PER RECINZIONI

DECORATIVE STAKES FOR FENCES

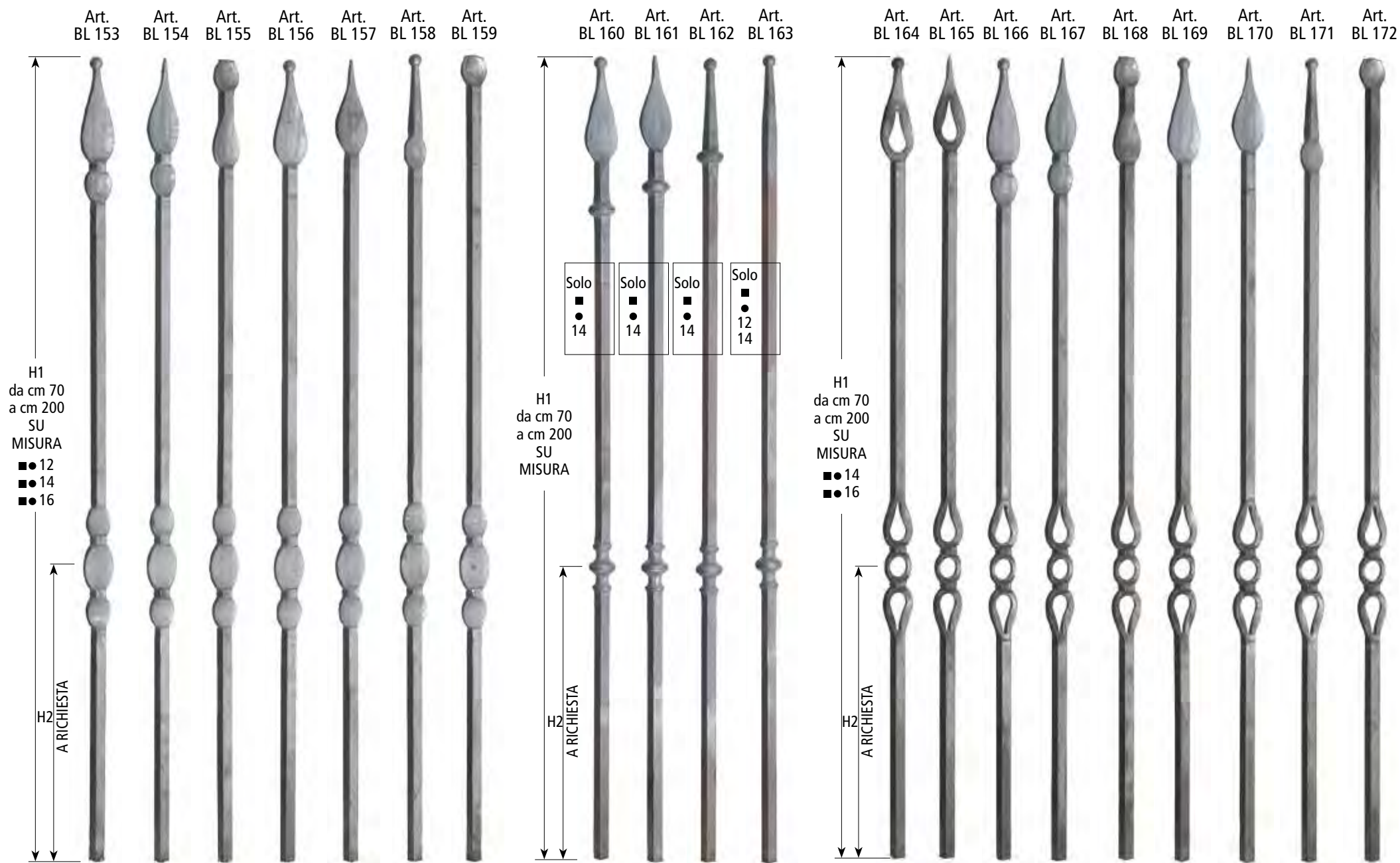

Tutte le decorazioni vengono eseguite anche con profili battuti. Per l'ordinazione del materiale fornire le misure dell'H1 e H2.

VERTICALI DECORATIVI PER RECINZIONI

DECORATIVE STAKES FOR FENCES

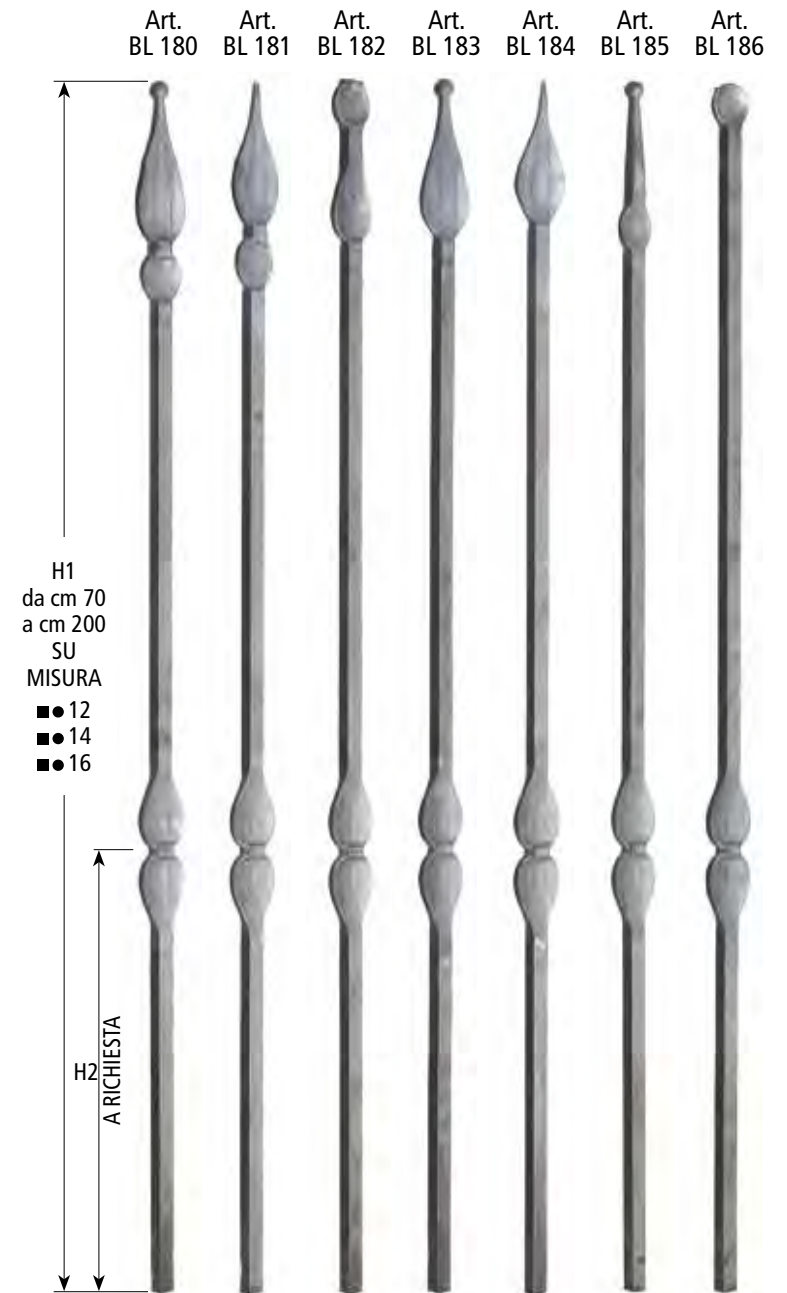
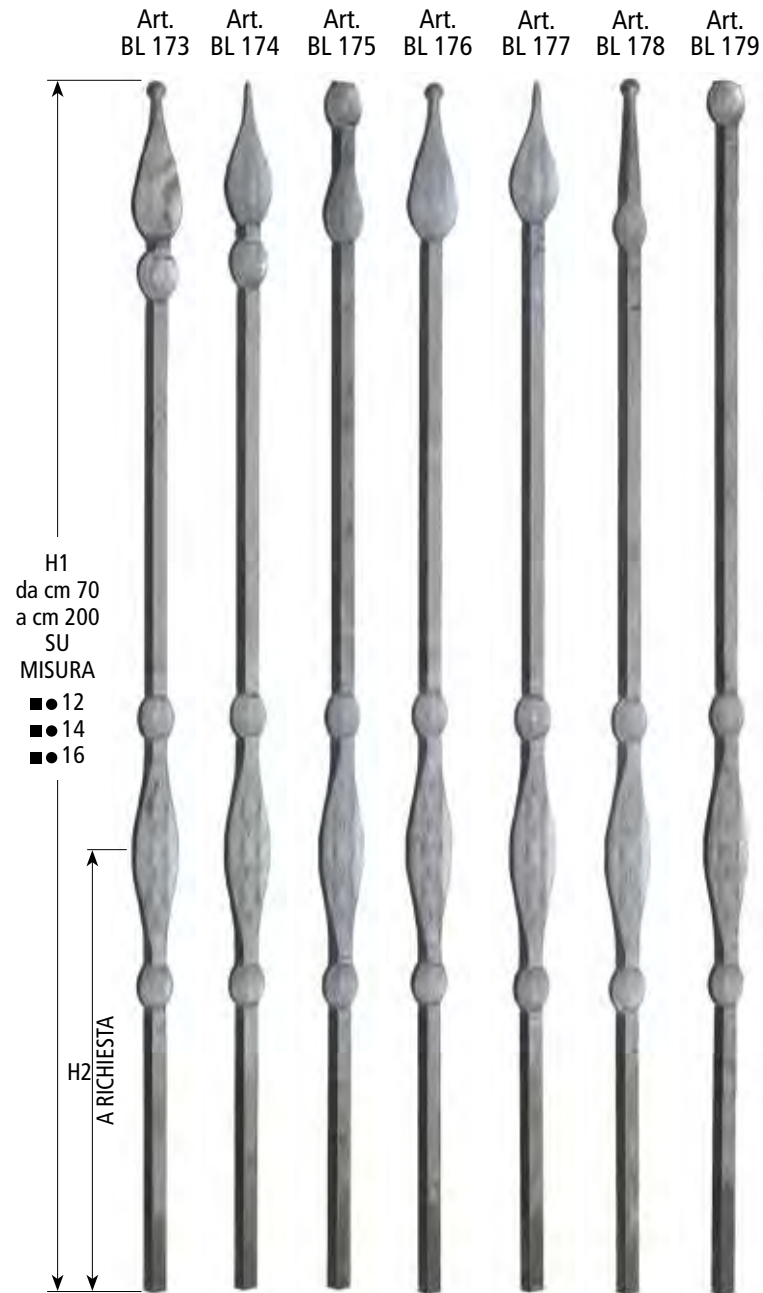

Tutte le decorazioni vengono eseguite anche con profili battuti. Per l'ordinazione del materiale fornire le misure dell'H1 e H2.

VERTICALI DECORATIVI PER INSERIMENTO ROSONI DI RECINZIONE

DECORATIVE STAKES FOR INSERTION ROSETTES FENCES

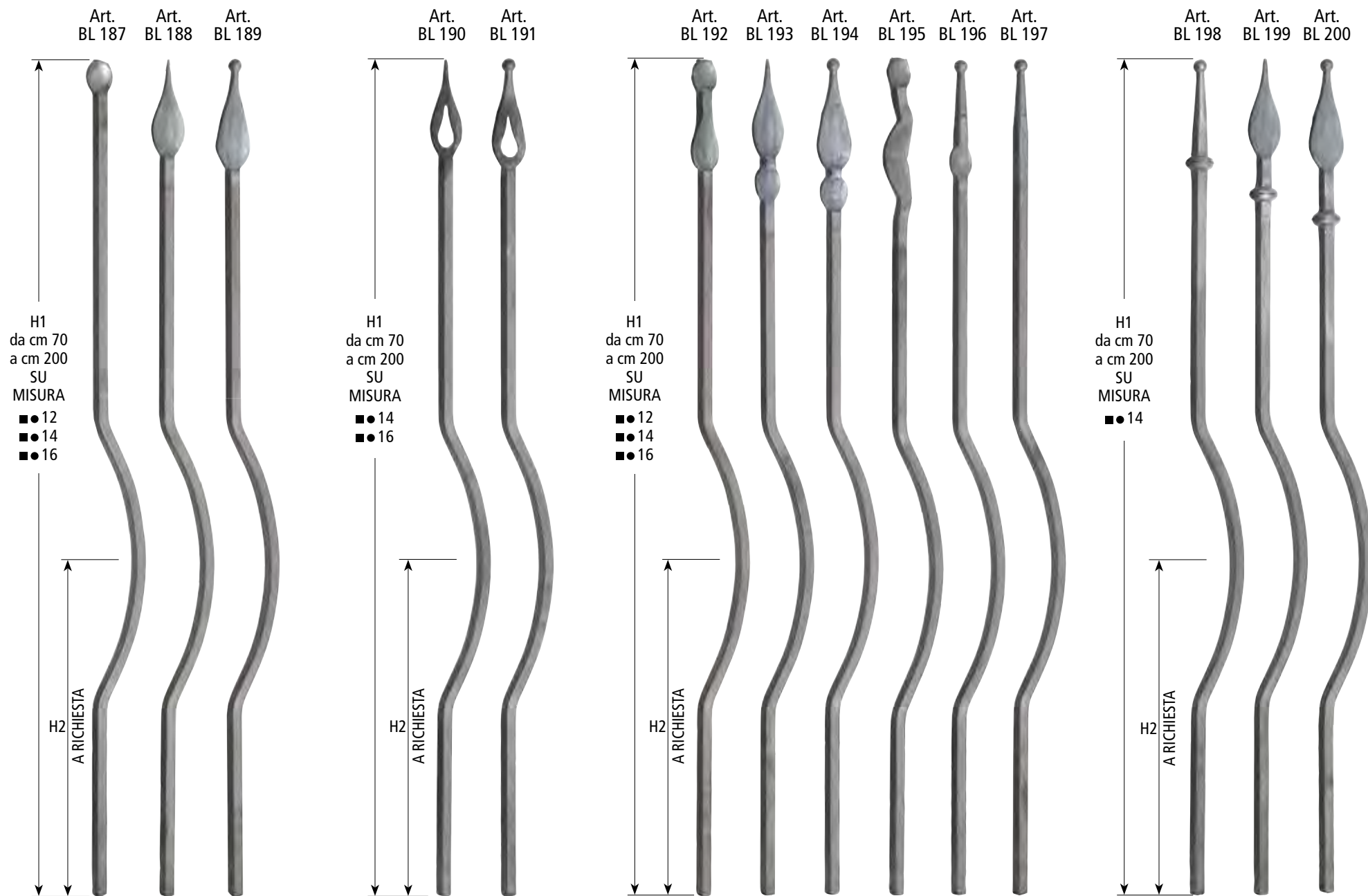

Paletti curvati per inserimento rosoni Artt. BL 81 - BL 83 - BL 86 - BL 88 - BL 90 - BL 91 - BL 92.

Tutte le decorazioni vengono eseguite anche con profili battuti. Per l'ordinazione del materiale fornire le misure dell'H1 e H2.

**I PIÙ
CONVE-
NIENTI**

VERTICALI DECORATIVI PER RECINZIONI

DECORATIVE STAKES FOR FENCES

Art. FC 180-3 Art. FC 180-4 Art. FC 180-5 Art. FC 180-6 Art. FC 180-7 Art. FC 180-8 Art. FC 180-10 Art. FC 180-11 Art. FC 180-12

Art. FC 181-3 Art. FC 181-4 Art. FC 181-5 Art. FC 181-6 Art. FC 181-7 Art. FC 181-8 Art. FC 181-10 Art. FC 181-11 Art. FC 181-12

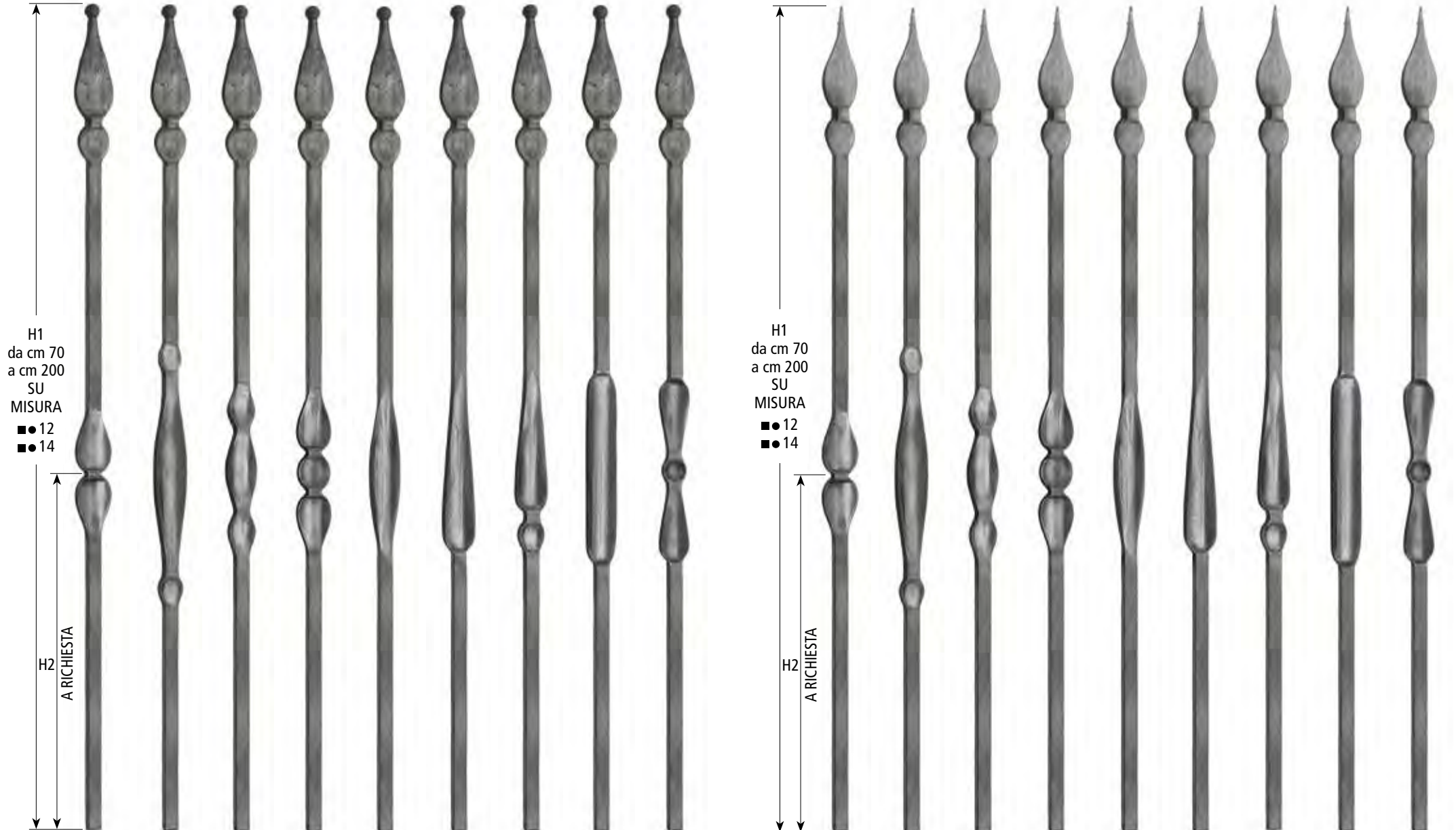

H1
da cm 70
a cm 200
SU
MISURA
■● 12
■● 14

H1
da cm 70
a cm 200
SU
MISURA
■● 12
■● 14

H2
A RICHIESTA

H2
A RICHIESTA

LANCIA STAMPATA A CALDO, DECORO STAMPATO A FREDDO

Per l'ordinazione del materiale fornire le misure dell'H1 e H2.

VERTICALI DECORATIVI PER RECINZIONI

DECORATIVE STAKES FOR FENCES

I PIÙ
CONVE-
NIENTI

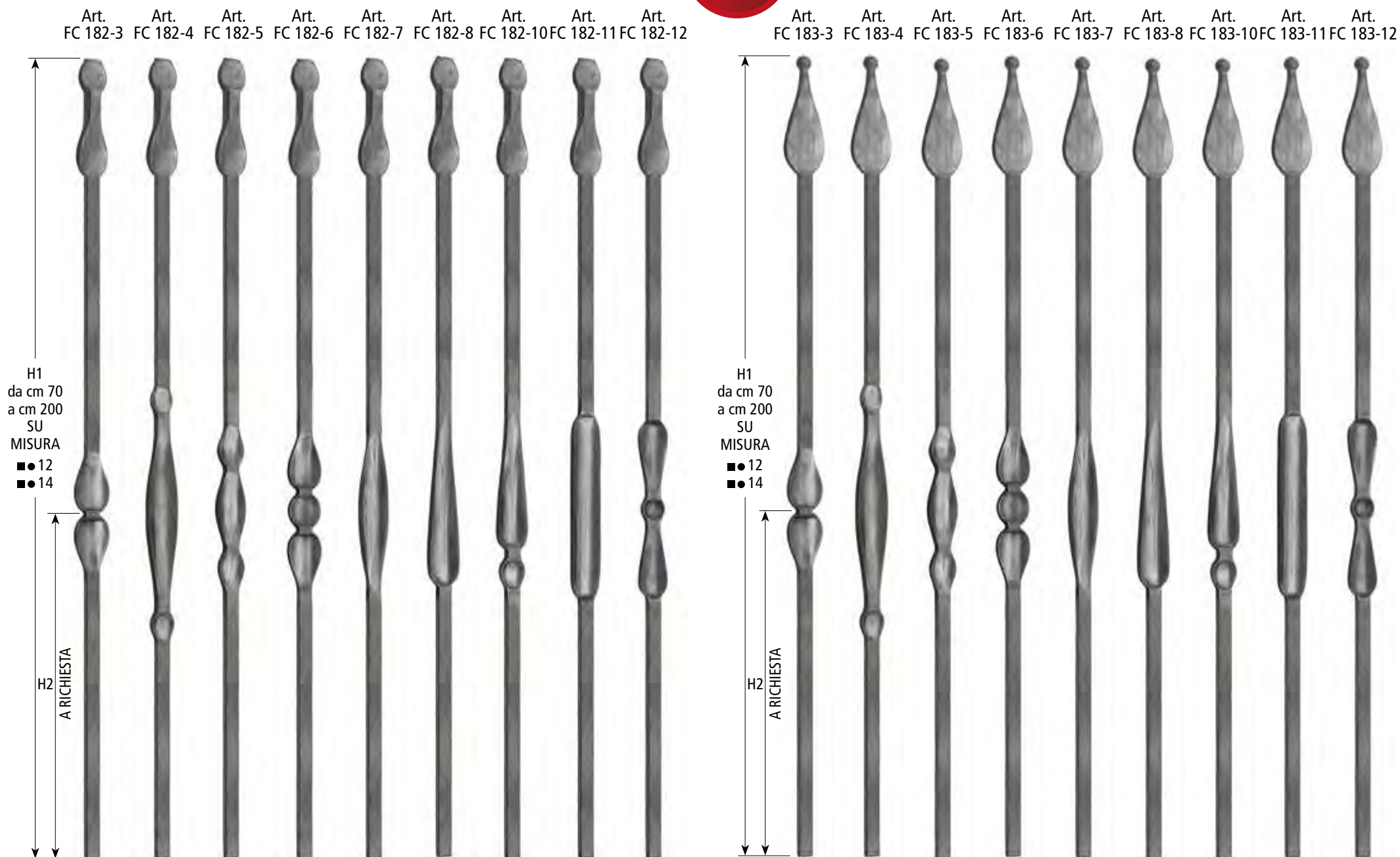

LANCIA STAMPATA A CALDO, DECORO STAMPATO A FREDDO

**I PIÙ
CONVENIENTI**

VERTICALI DECORATIVI PER RECINZIONI

DECORATIVE STAKES FOR FENCES

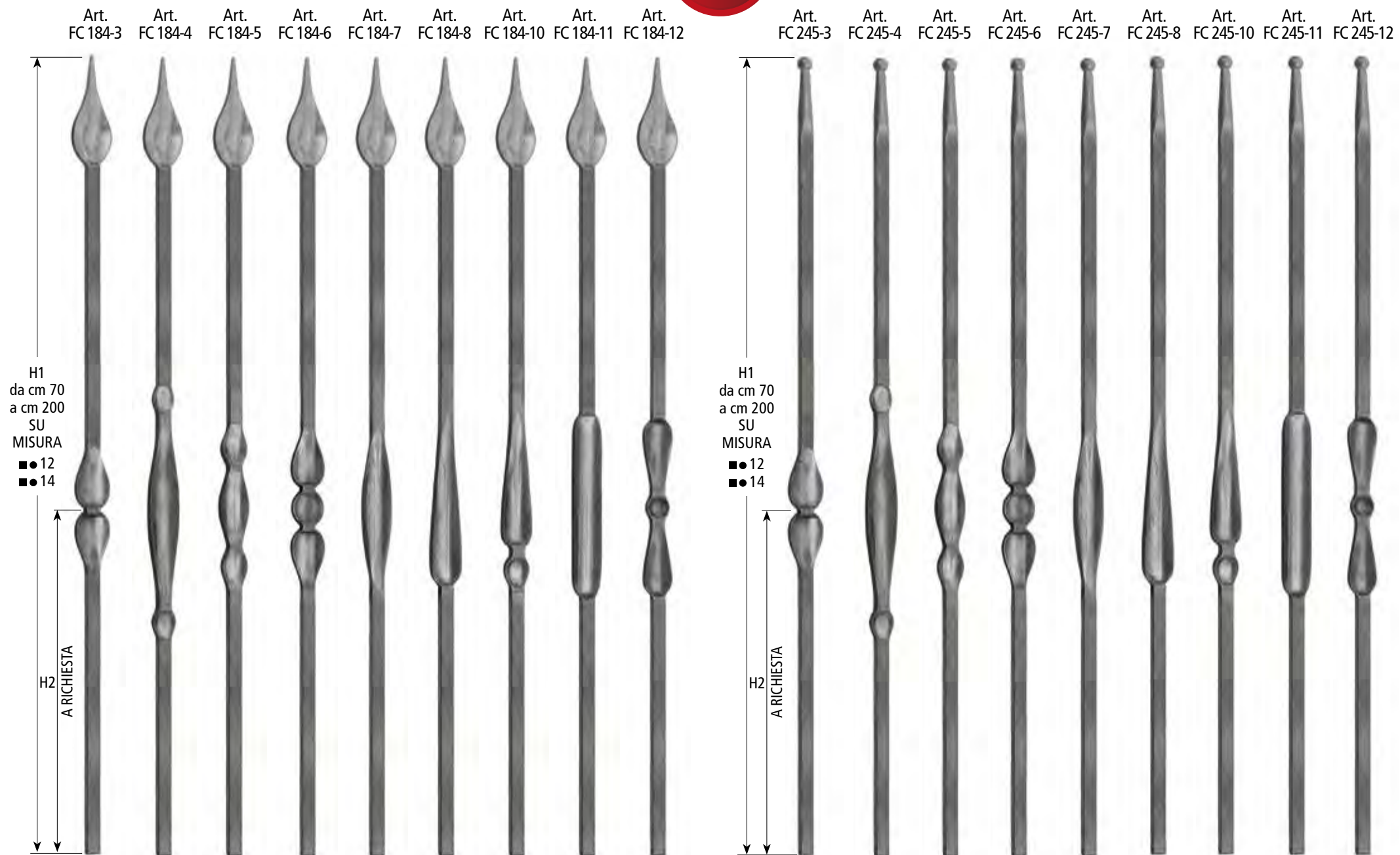

Art. FC 184-3 Art. FC 184-4 Art. FC 184-5 Art. FC 184-6 Art. FC 184-7 Art. FC 184-8 Art. FC 184-10 Art. FC 184-11 Art. FC 184-12

Art. FC 245-3 Art. FC 245-4 Art. FC 245-5 Art. FC 245-6 Art. FC 245-7 Art. FC 245-8 Art. FC 245-10 Art. FC 245-11 Art. FC 245-12

H1
da cm 70
a cm 200
SU
MISURA
■● 12
■● 14

H1
da cm 70
a cm 200
SU
MISURA
■● 12
■● 14

H2
A RICHIESTA

H2
A RICHIESTA

LANCIA STAMPATA A CALDO, DECORO STAMPATO A FREDDO

Per l'ordinazione del materiale fornire le misure dell'H1 e H2.

VERTICALI DECORATIVI PER RECINZIONI

DECORATIVE STAKES FOR FENCES

**I PIÙ
CONVE-
NIENTI**

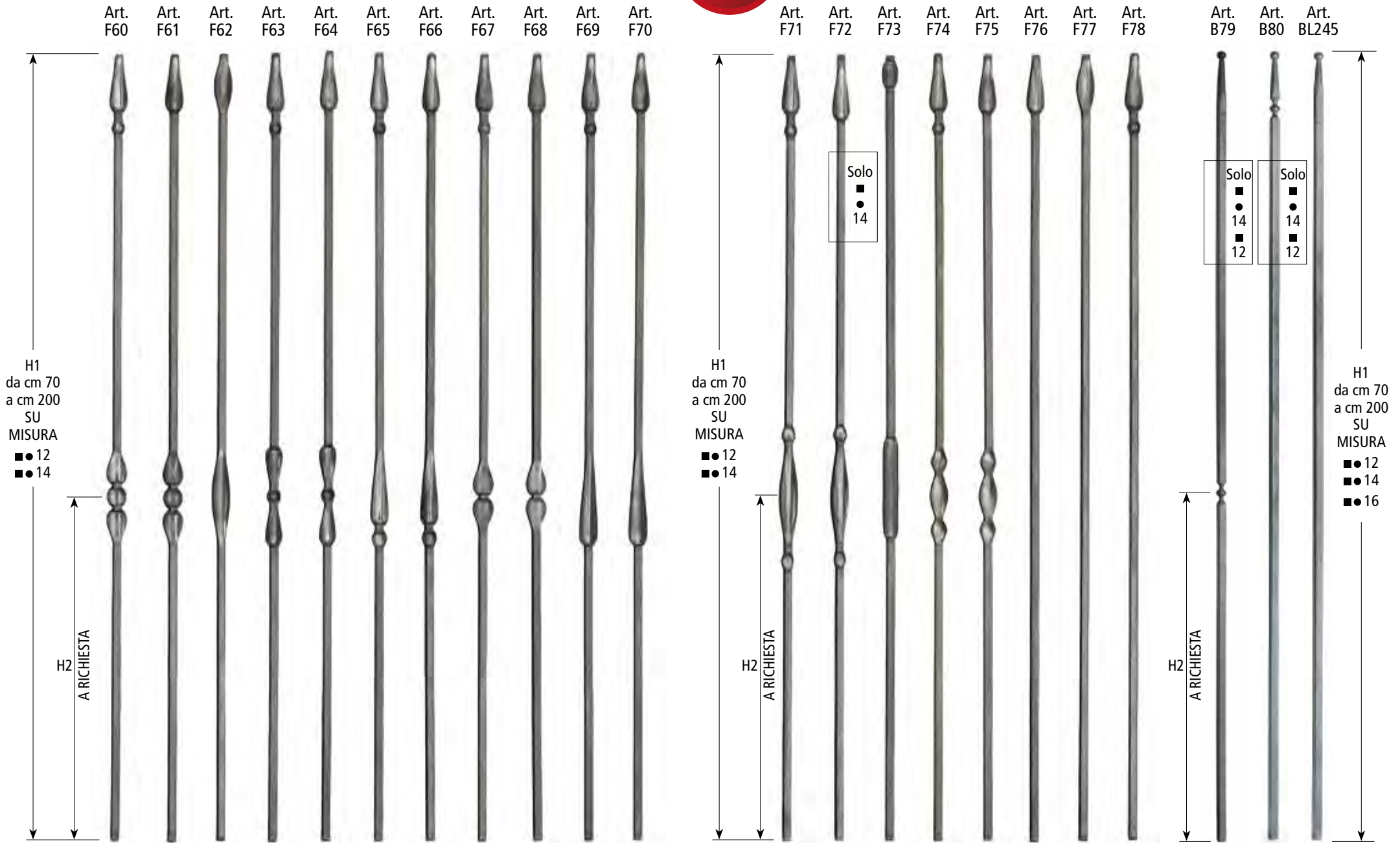

LANCIA E DECORO STAMPATI A FREDDO

Per l'ordinazione del materiale fornire le misure dell'H1 e H2.

VERTICALI E TERMINALI DECORATIVI PER CANCELLI

DECORATIVE STAKES AND TERMINALS FOR GATES

Art. 1181
Art. 1183
Art. 1187

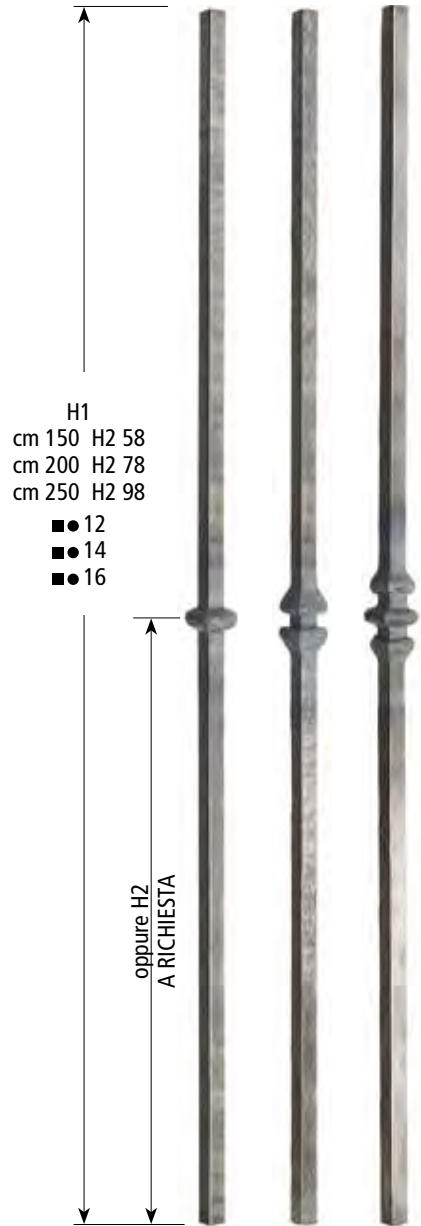

H1
cm 150 H2 58
cm 200 H2 78
cm 250 H2 98

■● 12
 ■● 14
 ■● 16

oppure H2
A RICHIESTA

Articolo	1209	1210	1211	1212	1213
Spessore ■●	12 14 16	12 14 16	12 14 16	12 14 16	12 14 16
Altezza mm	195 200 220	220 240 260	225 265 280	230 235 255	250 265 285
Articolo	1214	1216	1217	1218	BL 245
Spessore ■●	12 14 16	12 14 16	12 14 16	12 14 16	12 14 16
Altezza mm	255 285 285	245 245 275	270 280 310	280 300 320	150 150 150

Tutti i terminali si forniscono a misura fino ad altezza di cm 200.

Art. BL 70
Art. BL 71
Art. BL 72
Art. BL 73
Art. BL 74
Art. BL 75
Art. BL 76
Art. BL 77
Art. BL 78
Art. BL 80

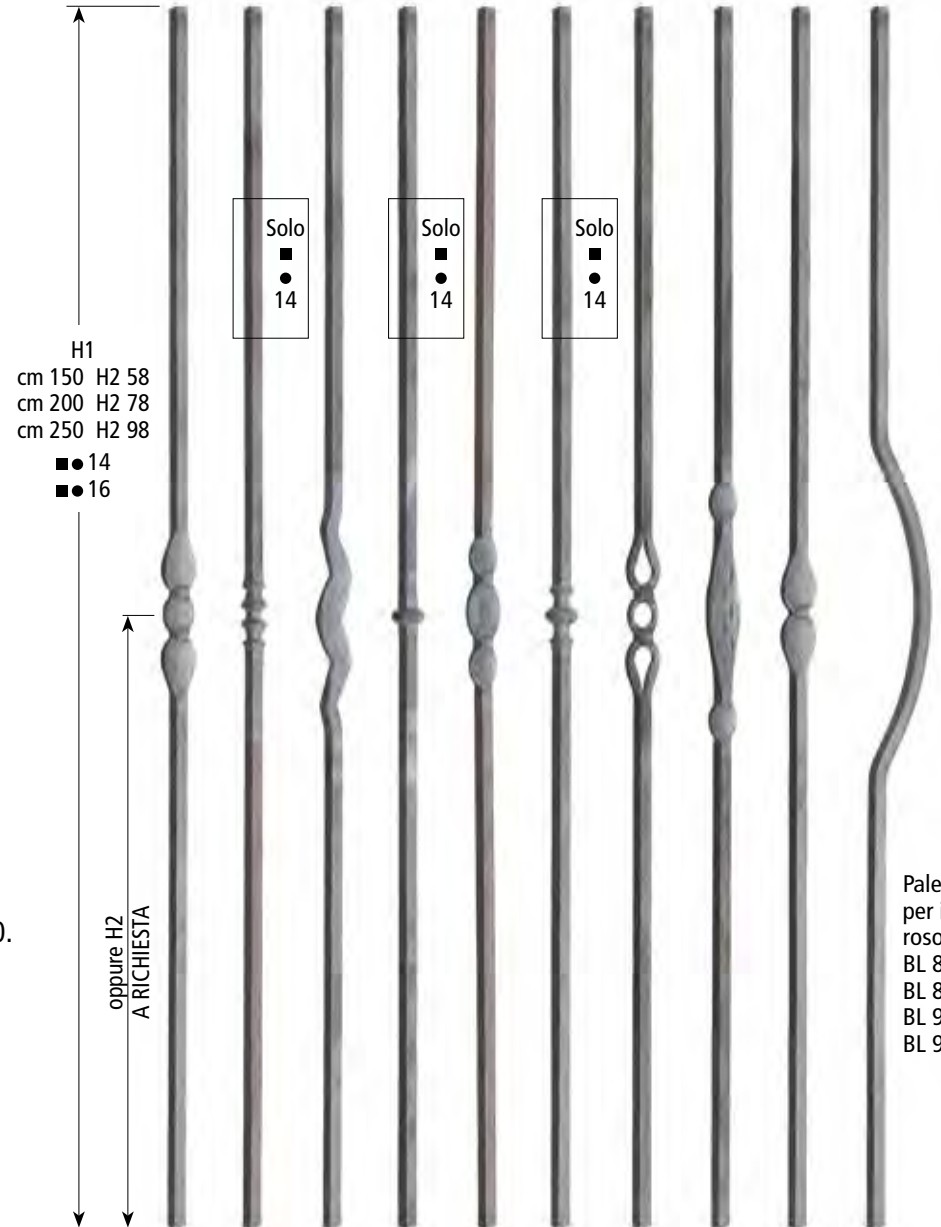

H1
cm 150 H2 58
cm 200 H2 78
cm 250 H2 98

■● 14
 ■● 16

oppure H2
A RICHIESTA

Paletto curvato
per inserimento
rosoni Art.
BL 81, BL 83,
BL 86, BL 88,
BL 90, BL 91,
BL 92.

Tutte le decorazioni vengono eseguite anche con profili battuti. Per l'ordinazione del materiale fornire le misure dell'H1 e H2.

TERMINALI DECORATIVI PER CANCELLI IN PROFILO QUADRO E TONDO

DECORATIVE TERMINALS FOR GATES

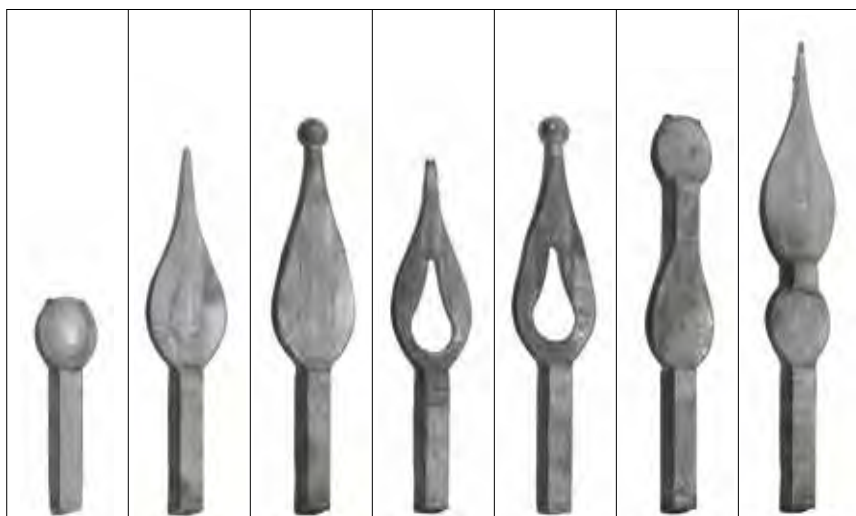

Articolo	BL 235			BL 236			BL 237			BL 238		BL 239		BL 240			BL 241		
Spessore ■	12	14	16	12	14	16	12	14	16	14	16	14	16	12	14	16	12	14	16
Altezza mm	120	120	120	150	165	180	185	200	205	170	210	205	205	200	200	200	210	225	245

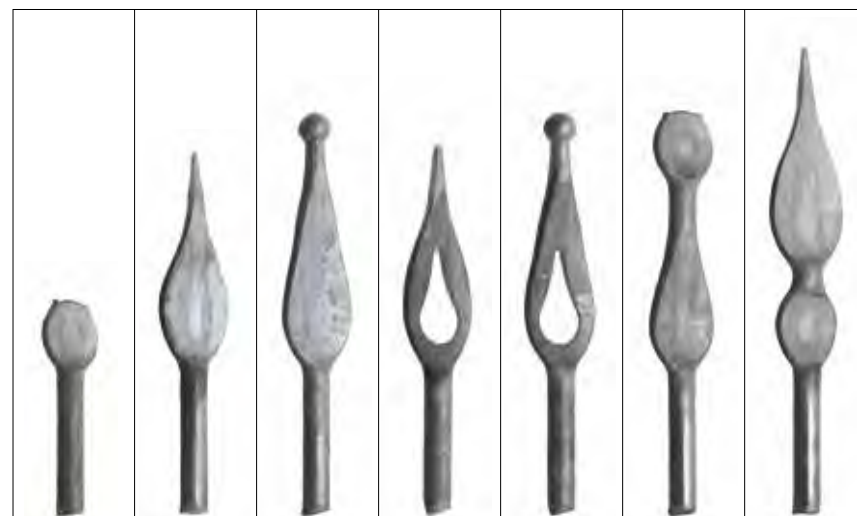

Articolo	BL 235			BL 236			BL 237			BL 238		BL 239		BL 240			BL 241		
Spessore ●	12	14	16	12	14	16	12	14	16	14	16	14	16	12	14	16	12	14	16
Altezza mm	120	120	120	150	165	180	185	200	205	170	210	205	205	200	200	200	210	225	245



Articolo	BL 242			BL 243			BL 244			BL 245			BL 246		BL 247		BL 248		BL 249		
Spessore ■	12	14	16	12	14	16	12	14	16	12	14	16	14	14	14	14	14	14	12	14	16
Altezza mm	230	250	250	240	250	250	205	210	220	150	150	150	210	240	270	150	150	150			



Articolo	BL 242			BL 243			BL 244			BL 245			BL 246		BL 247		BL 248		BL 249		
Spessore ●	12	14	16	12	14	16	12	14	16	12	14	16	14	14	14	14	14	14	12	14	16
Altezza mm	230	250	250	240	250	250	205	210	220	150	150	150	210	240	270	150	150	150			

Tutti i terminali in ferro quadro vengono eseguiti anche con profili battuti.

Tutti i terminali si forniscono a misura fino ad altezza di cm 200.

VERTICALI DECORATIVI PER CANCELLI E RECINZIONI

DECORATIVE STAKES FOR FENCES



Art. BL 59 Art. BL 300 Art. BL 61 Art. BL 301 Art. BL 63 Art. BL 302 Art. BL 65 Art. BL 66 Art. BL 67 Art. BL 69 Art. BL 303 Art. BL 304 Art. AM1455
 spessore mm 6 solo liscio

H1 da cm 70 a cm 200 SU MISURA

H2 A RICHIESTA

Solo
 ■ 12
 ● 14

Solo
 ■ 14
 ● 14

Solo
 ■ 12
 ● 14

Solo
 ■ 14
 ● 16

Paletto curvato per inserimento rosoni Art. BL 81, BL 83, BL 86, BL 88, BL 90, BL 91, BL 92.

A RICHIESTA

cm 12

cm 16

Tutte le decorazioni vengono eseguite anche con profili battuti. Per l'ordinazione del materiale fornire le misure dell'H1 e H2.

PANNELLI DECORATIVI PER BASE CANCELLI

DECORATIVE METAL SHEET

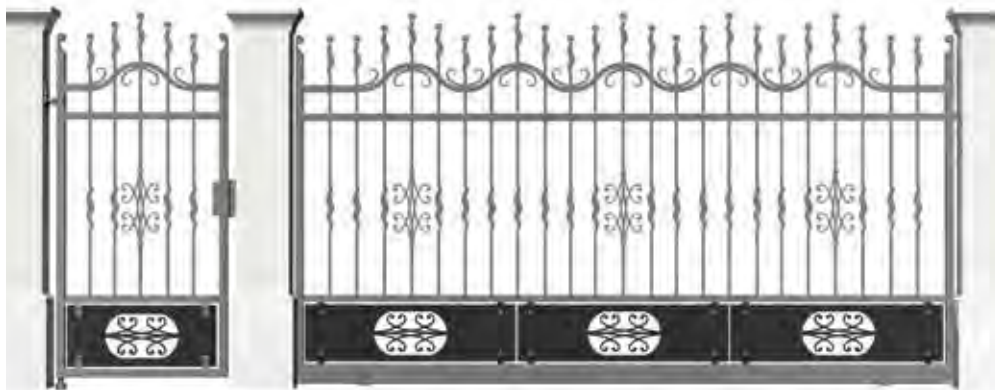

Art. BL 270 SPESSORE MM 4 - MM 6 – Si forniscono solo lisce

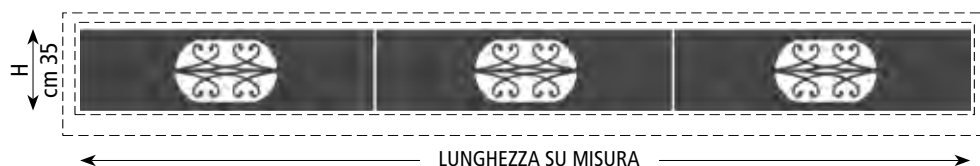

Art. BL 271
SPESSORE MM 4 - MM 6
Si forniscono solo lisce



Art. BL 272 SPESSORE MM 4 - MM 6 – Si forniscono solo lisce



Art. BL 273
SPESSORE MM 4 - MM 6
Si forniscono solo lisce



Art. BL 274 SPESSORE MM 4 - MM 6 – Si forniscono solo lisce



Art. BL 275
SPESSORE MM 4 - MM 6
Si forniscono solo lisce



Art. BL 276 SPESSORE MM 4 - MM 6 – Si forniscono solo lisce

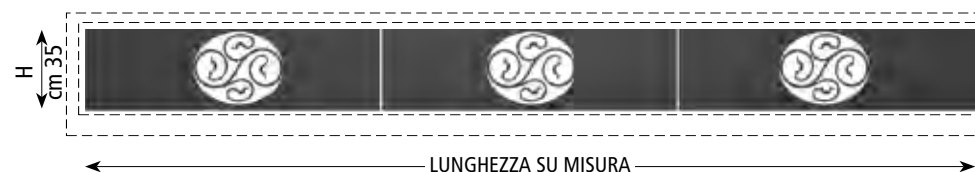

Art. BL 277
SPESSORE MM 4 - MM 6
Si forniscono solo lisce



Staffa e bullone di collegamento per pannelli in lamiera

Art. BL 280

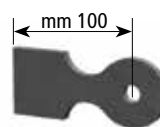

Staffa di fissaggio su colonna e pannello in lamiera
Dim. mm 120x40

spessore mm 4 Foro mm 12
spessore mm 6 Foro mm 13
Grezzo

Art. BL 370



Bulloni per staffe di fissaggio pannelli in lamiera



CURVE DECORATIVE PER CANCELLI

DECORATIVE GATE TOPS

Art. BL 250
Si forniscono anche battute

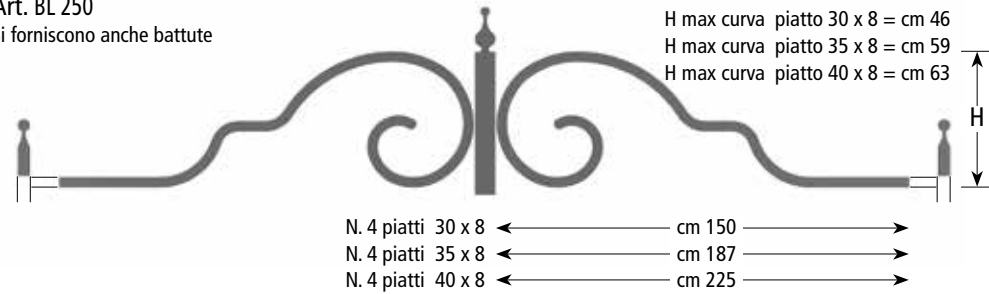

Art. BL 251
Si forniscono solo lisce

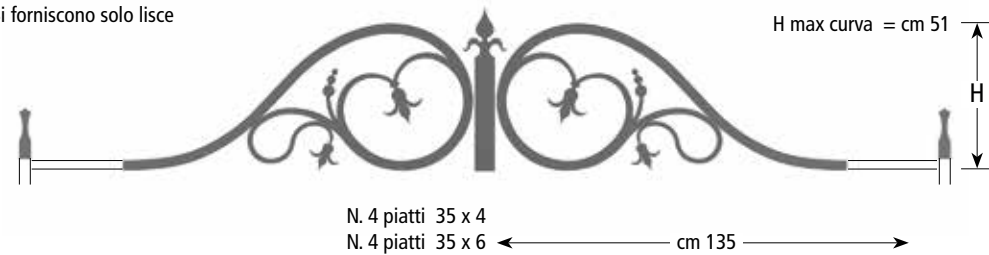

Art. BL 252
Si forniscono solo lisce

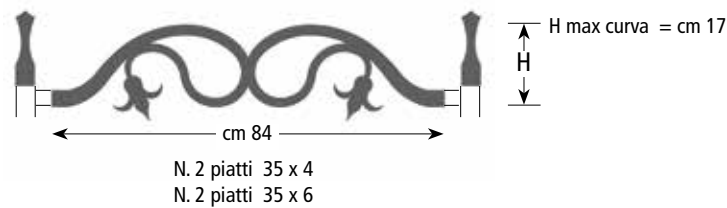

Art. BL 253
Si forniscono solo lisce

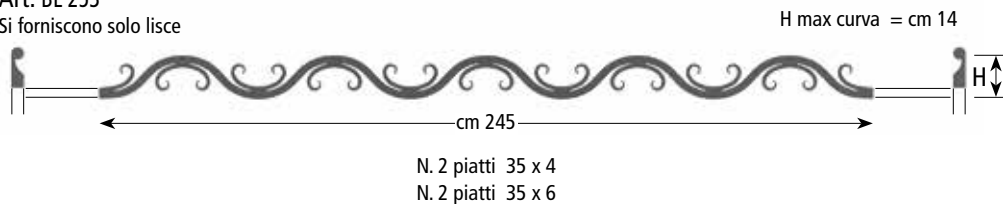

Art. BL 254
Si forniscono solo lisce

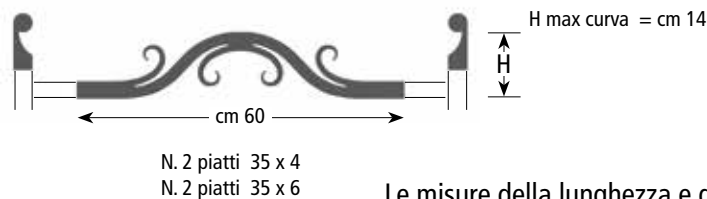

Art. BL 255
Si forniscono solo lisce

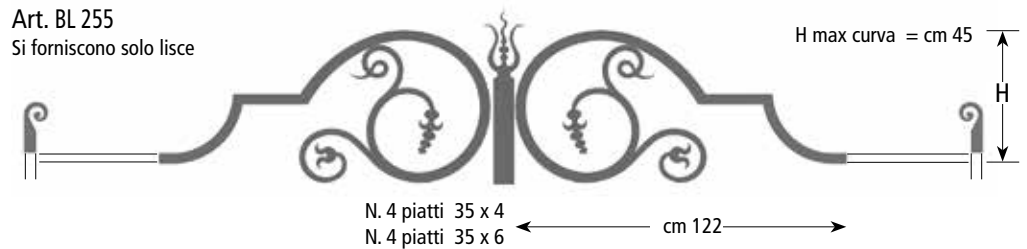

Art. BL 256
Si forniscono solo lisce

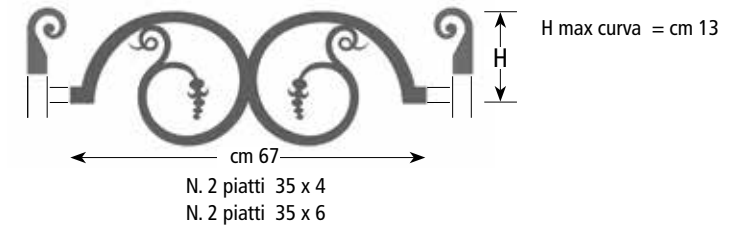

Art. BL 257
Si forniscono anche battute

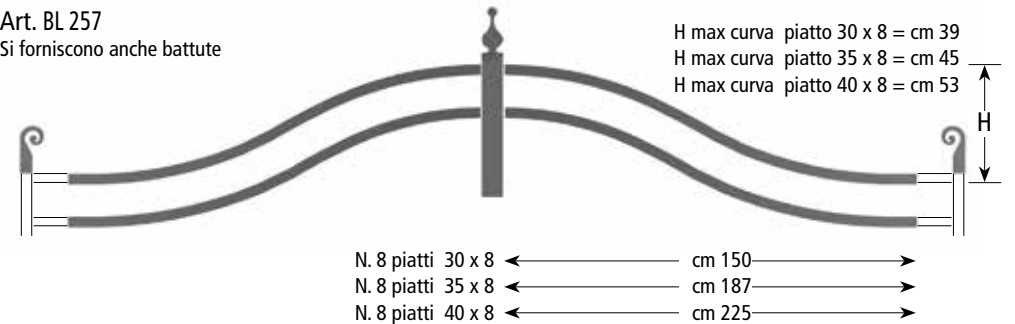

Art. BL 258
Si forniscono anche battute

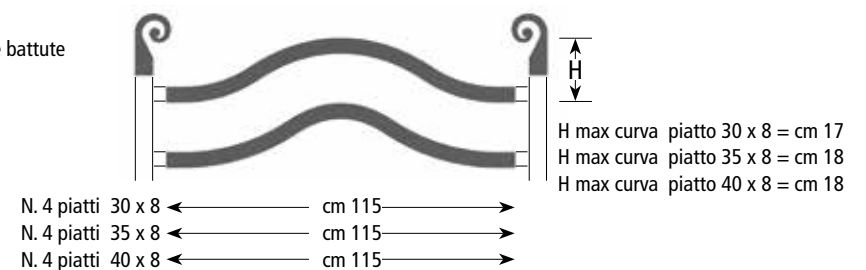

Le misure della lunghezza e dell'altezza delle curve possono subire delle leggere variazioni durante la lavorazione.

CURVE DECORATIVE PER CANCELLI

DECORATIVE GATE TOPS

Art. BL 259

Si forniscono solo lisce

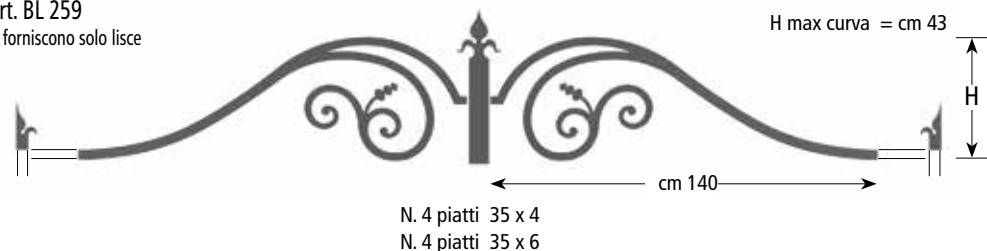

Art. BL 263

Si forniscono anche battute

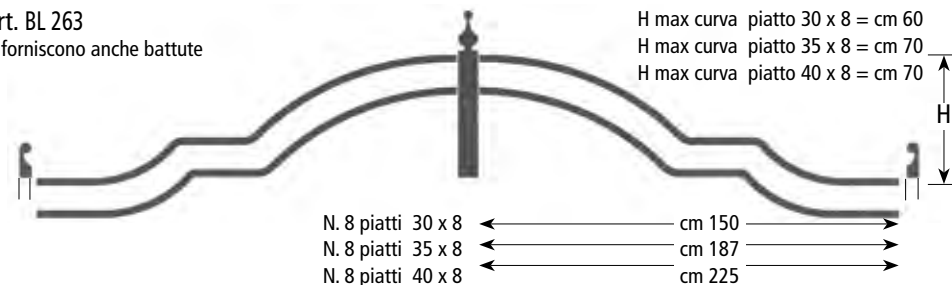

Art. BL 260

Si forniscono solo lisce

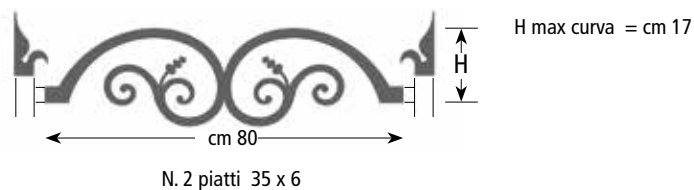

Art. BL 266

Si forniscono anche battute

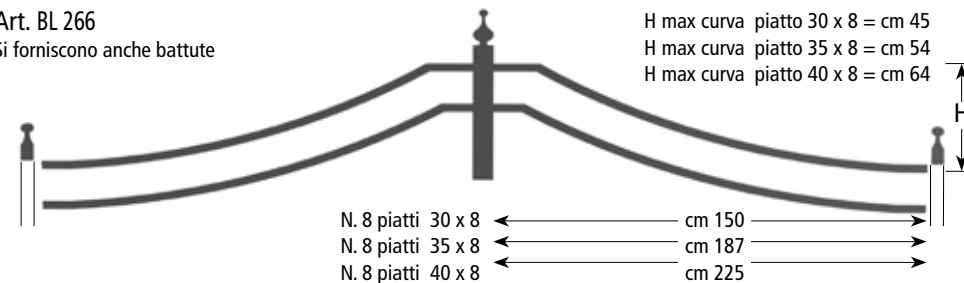

Art. BL 261

Si forniscono solo lisce

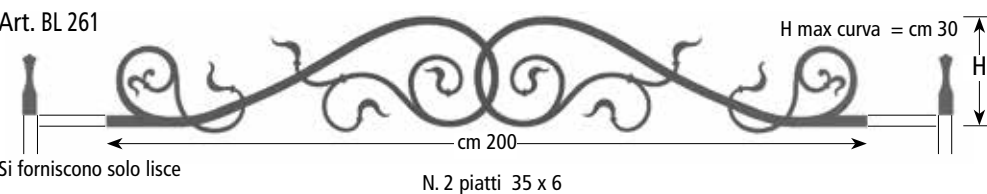

Art. BL 267

Si forniscono anche battute

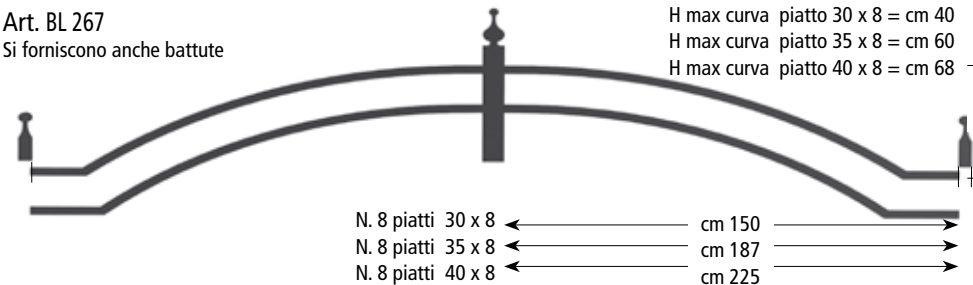

Art. BL 262

Si forniscono solo lisce

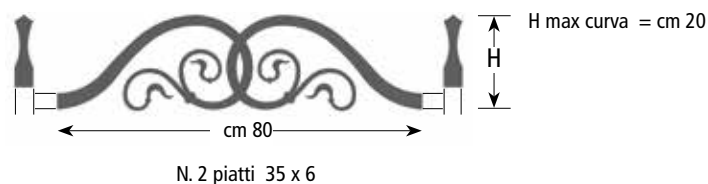

Le misure della lunghezza e dell'altezza delle curve possono subire delle leggere variazioni durante la lavorazione.

TERMINALI PER BATTENTI E PER MONTANTI

TERMINALS FOR GATES

Art. BL 210



Art. BL 212



Art. BL 215

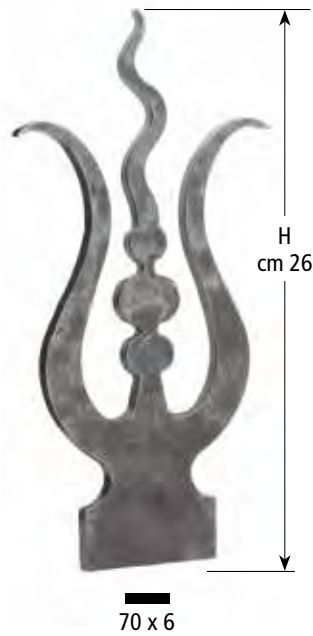

Art. BL 220

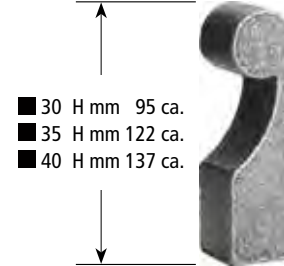

Art. BL 221

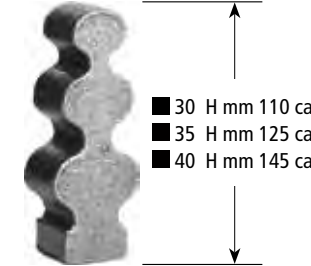

Art. BL 222



Art. BL 223

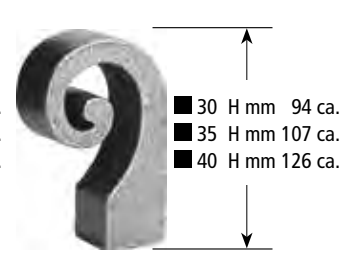

Art. BL 224

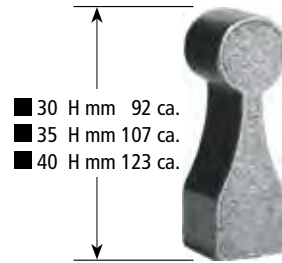

Art. BL 225

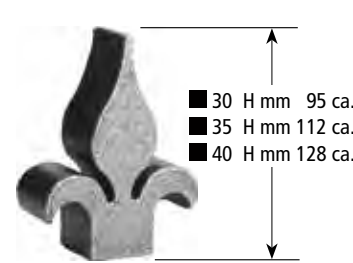

Art. BL 226

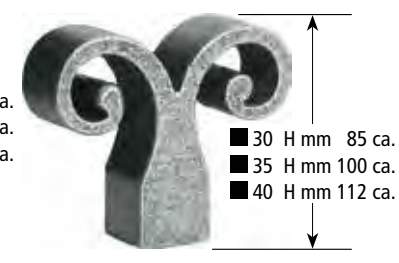

Art. BL 227

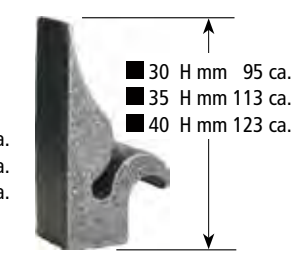

Art. BT 1



Art. BT43D



Art. BL 214



Art. 1175

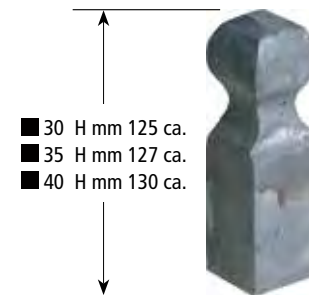

Art. 1174



- OSSITAGLIATI - SBAVATI

VERTICALI DECORATIVI PER INFERRIATE SPORGENTI ED INTERNE

DECORATIVE STAKES FOR EXTERIOR AND INTERIOR GRATES

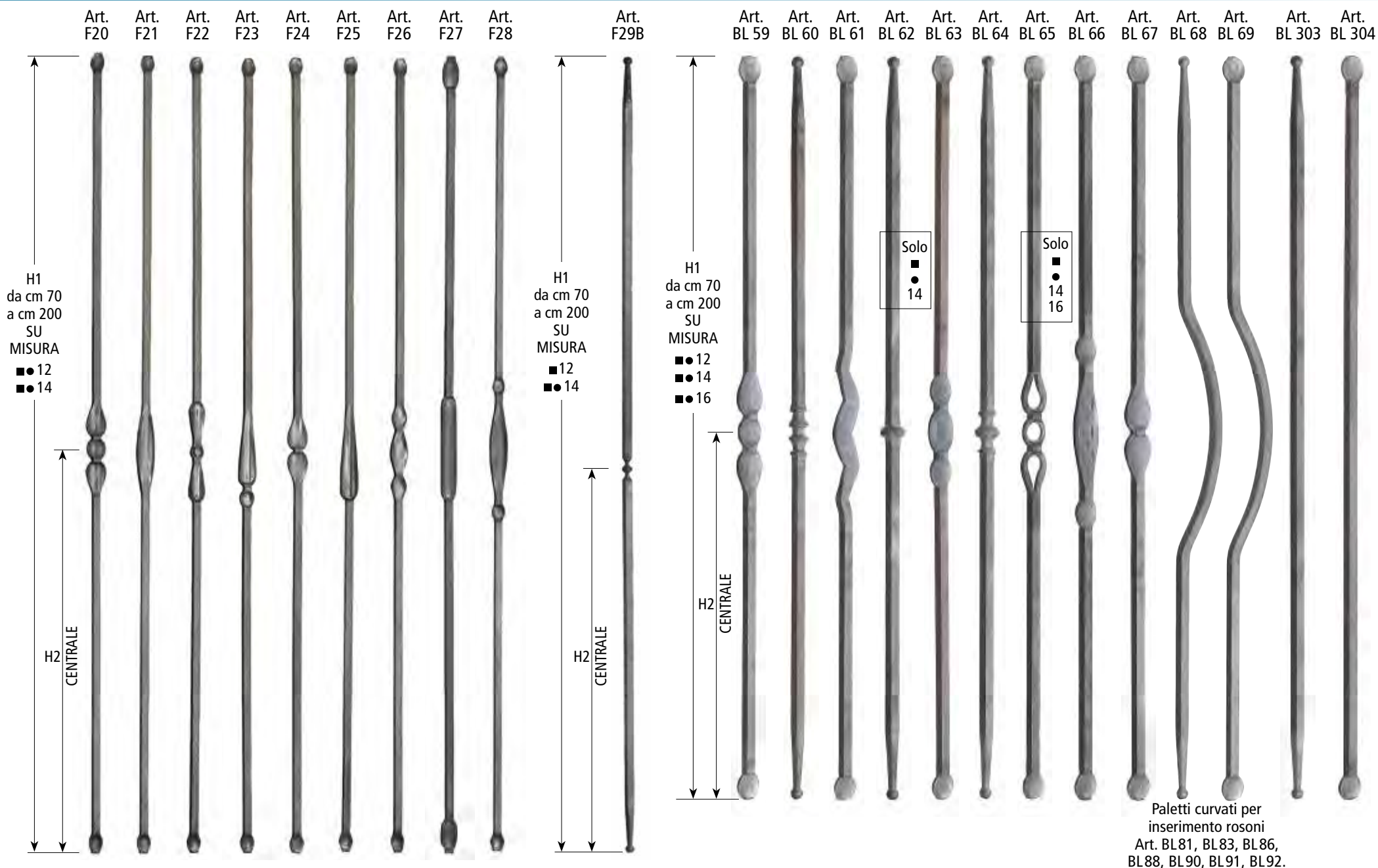

LANCIA E DECORO STAMPATI A FREDDO

Tutte le decorazioni vengono eseguite anche con profili battuti.

VERTICALI DECORATIVI PER INFERRIATE SPORGENTI ED INTERNE

DECORATIVE STAKES FOR EXTERIOR AND INTERIOR GRATES

Art. 1021 Art. 1023 Art. 1027 Art. 1041 Art. 1043 Art. 1047

H da cm 90 a cm 200 SU MISURA
 ■● 12
 ■● 14

H1 da cm 70 a cm 180 SU MISURA
 ■● 12
 ■● 14

H2 CENTRALE

Per l'ordinazione delle inferriate interne e sporgenti è sufficiente specificare le misure H e L luce interna finestra. Vi saranno così forniti i verticali e i trasversali SU MISURA.

Interasse SU RICHIESTA MINIMO CM 10,5 Art. 1050

Si forniscono SU MISURA ■● 16 foro 14

Interasse SU RICHIESTA MINIMO CM 10,5 Art. 1051

Si forniscono SU MISURA ■● 16 foro 14

Art. BL 50 Art. BL 51 Art. BL 52 Art. BL 53 Art. BL 54 Art. BL 55 Art. BL 56 Art. BL 57 Art. BL 58

H da cm 90 a cm 200 SU MISURA
 ■● 12
 ■● 14

Solo
 ■● 14

Solo
 ■● 14

Per l'ordinazione delle inferriate interne Artt. BL 1, BL 6, BL 11, BL 16, BL 21, BL 26, BL 31, BL 36, BL 41, è sufficiente specificare le misure H e L luce interna finestra. Vi saranno così forniti i verticali e i trasversali SU MISURA.

Per l'ordinazione delle inferriate sporgenti Artt. BL 3, BL 8, BL 13, BL 18, BL 23, BL 28, BL 33, BL 38, BL 43, è sufficiente specificare le misure H e L luce interna finestra. Vi saranno così forniti i verticali e i trasversali SU MISURA.

Art. BL 49

Si forniscono SU MISURA
 — 25 x 6

Tutte le decorazioni vengono eseguite anche con profili battuti.

VERTICALI DECORATIVI PER INFERRIATE SPORGENTI ED INTERNE

DECORATIVE STAKES FOR EXTERIOR AND INTERIOR GRATES

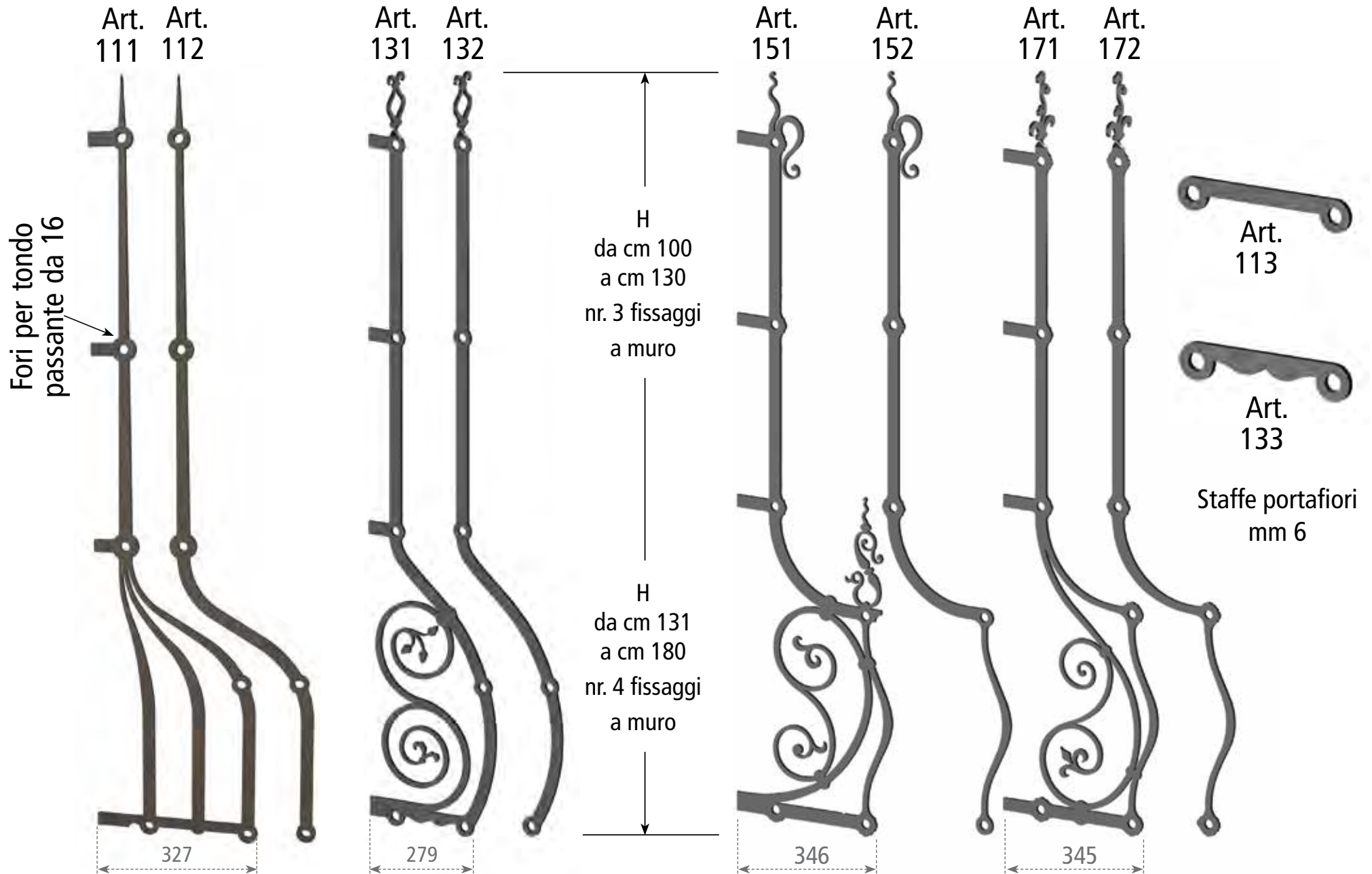

SI FORNISCONO SOLO LISCI - SPESSORE MM 6

VERTICALI DECORATIVI PER INFERRIATE SPORGENTI ED INTERNE

DECORATIVE STAKES FOR EXTERIOR AND INTERIOR GRATES

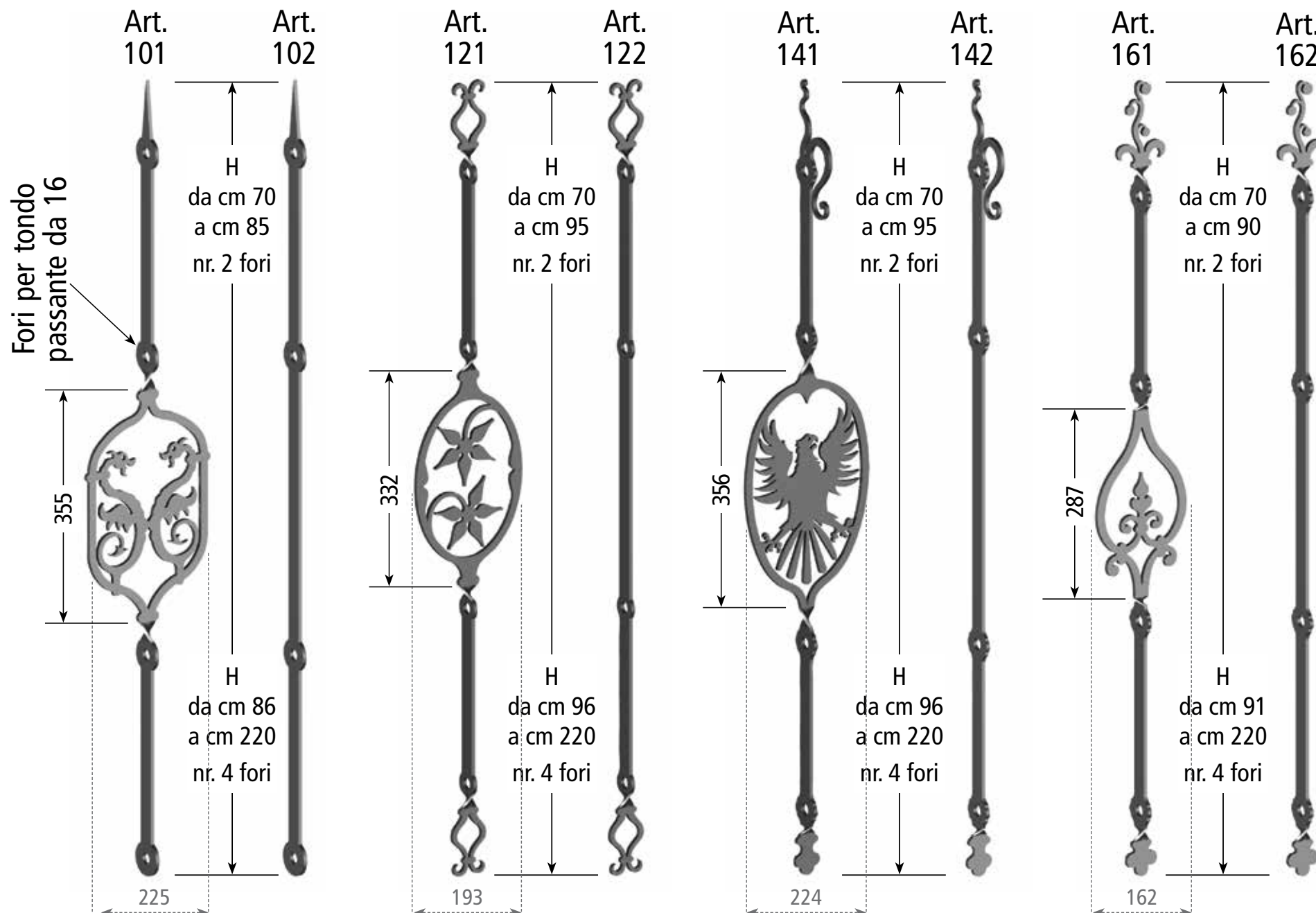

SI FORNISCONO SOLO LISCI - SPESSORE MM 6

VERTICALI DECORATIVI PER CANCELLETTI PORTA

DECORATIVE STAKES FOR SECURITY GATES

Art. F40 Art. F41 Art. F42 Art. F43 Art. F44 Art. F45 Art. F46 Art. F47 Art. F48 Art. B49 Art. 1031 Art. 1033 Art. 1037 Art. BL 70 Art. BL 71 Art. BL 72 Art. BL 73 Art. BL 74 Art. BL 75 Art. BL 76 Art. BL 77 Art. BL 78 Art. BL 80

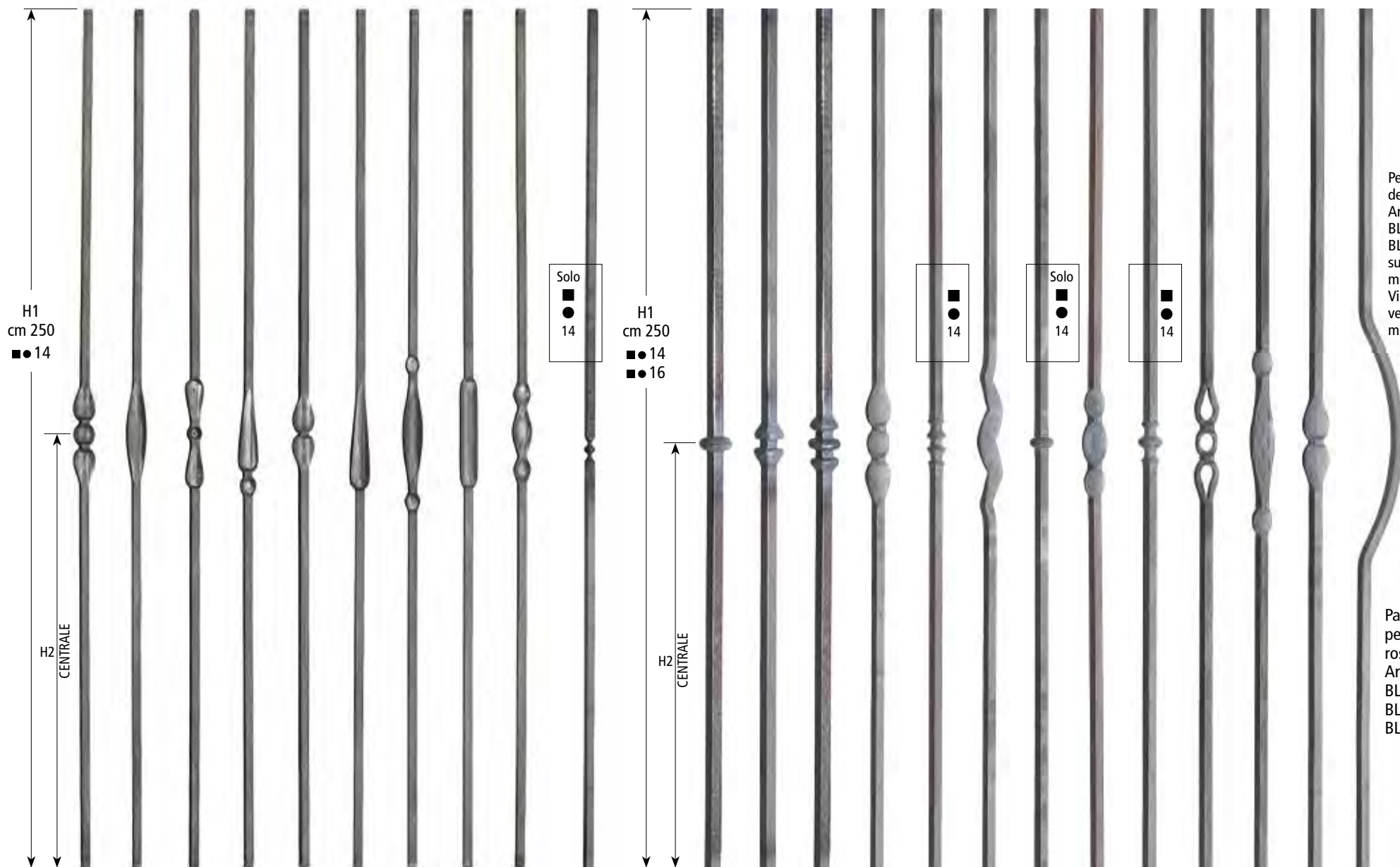

Per l'ordinazione dei cancelletti porta Art. BL 2, BL 7, BL 12, BL 17, BL 22, BL 27, BL 32, BL 37, BL 42, è sufficiente comunicare le misure H e L luce foro. Vi saranno così forniti verticali e trasversali su misura.

Paletto curvo per inserimento rosoni Art. BL 81, BL 83, BL 86, BL 88, BL 90, BL 91, BL 92.

DECORO STAMPATO A FREDDO

Tutte le decorazioni vengono eseguite anche con profili battuti.

VERTICALI DECORATIVI PER CANCELLETTI PORTA

DECORATIVE STAKES FOR SECURITY GATES

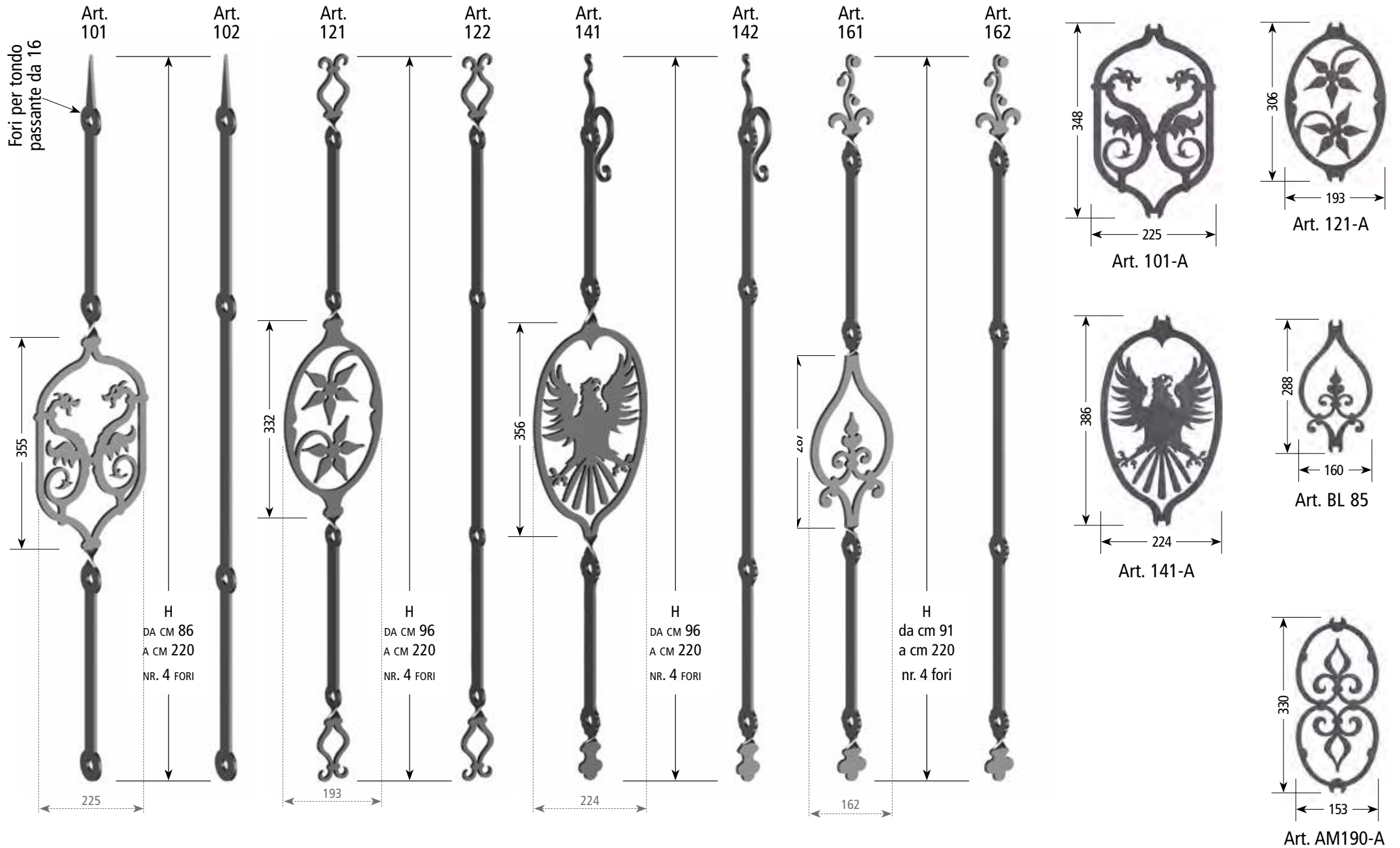

SI FORNISCONO SOLO LISCI - SPESSORE MM 6

VERTICALI DECORATIVI PER SCALE E BALCONI

DECORATIVE STAKES FOR STAIRCASES AND BALUSTRADES

**I PIÙ
CONVENIENTI**

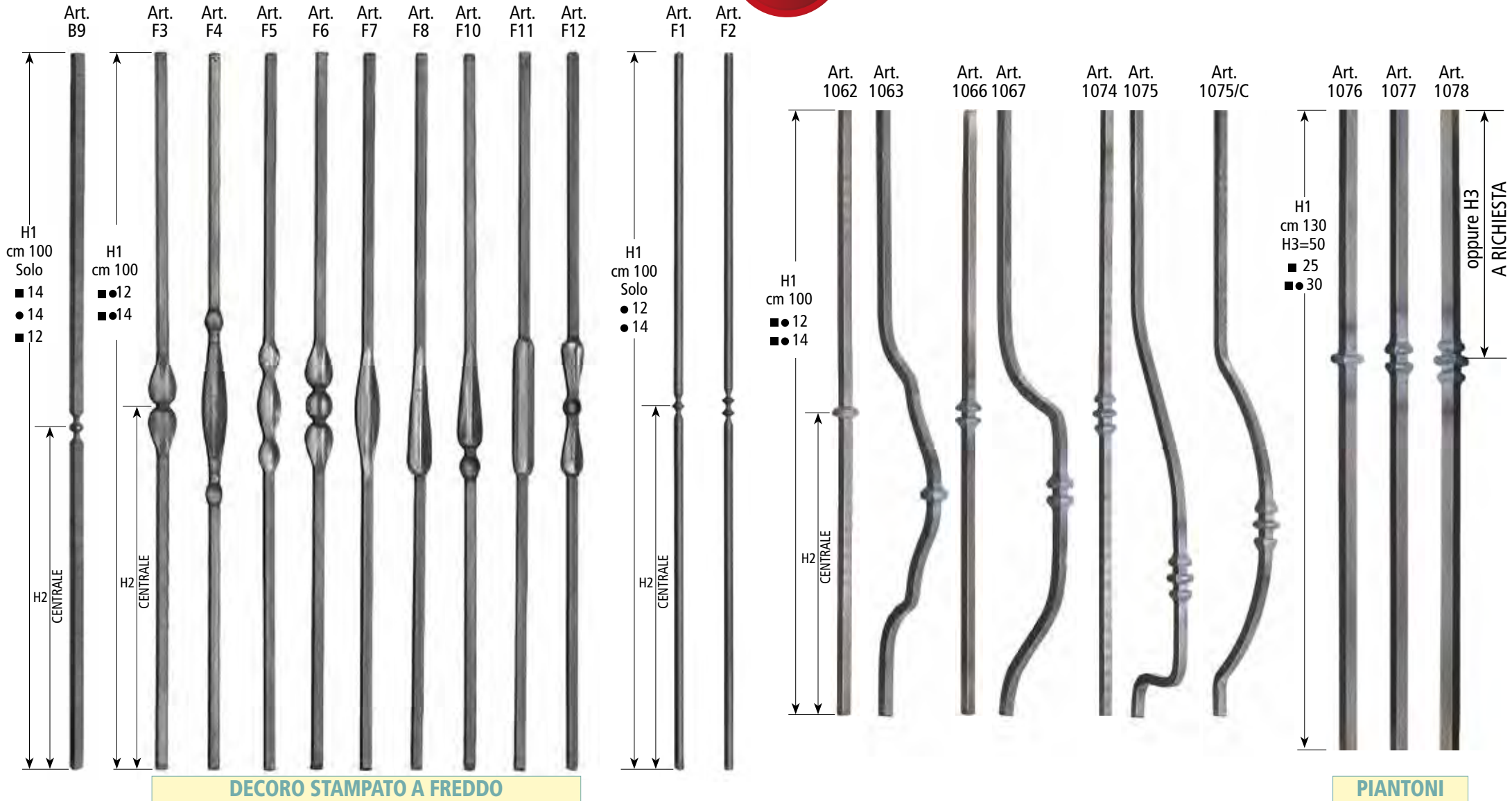

Queste decorazioni vengono eseguite anche con profili battuti.



Art. BL 124
Ricciolo terminale
50x14 45x12 40x11

VERTICALI DECORATIVI PER SCALE E BALCONI

DECORATIVE STAKES FOR STAIRCASES AND BALUSTRADES

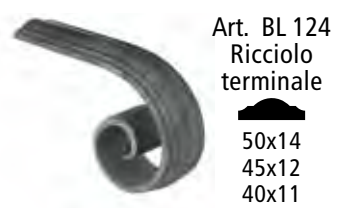
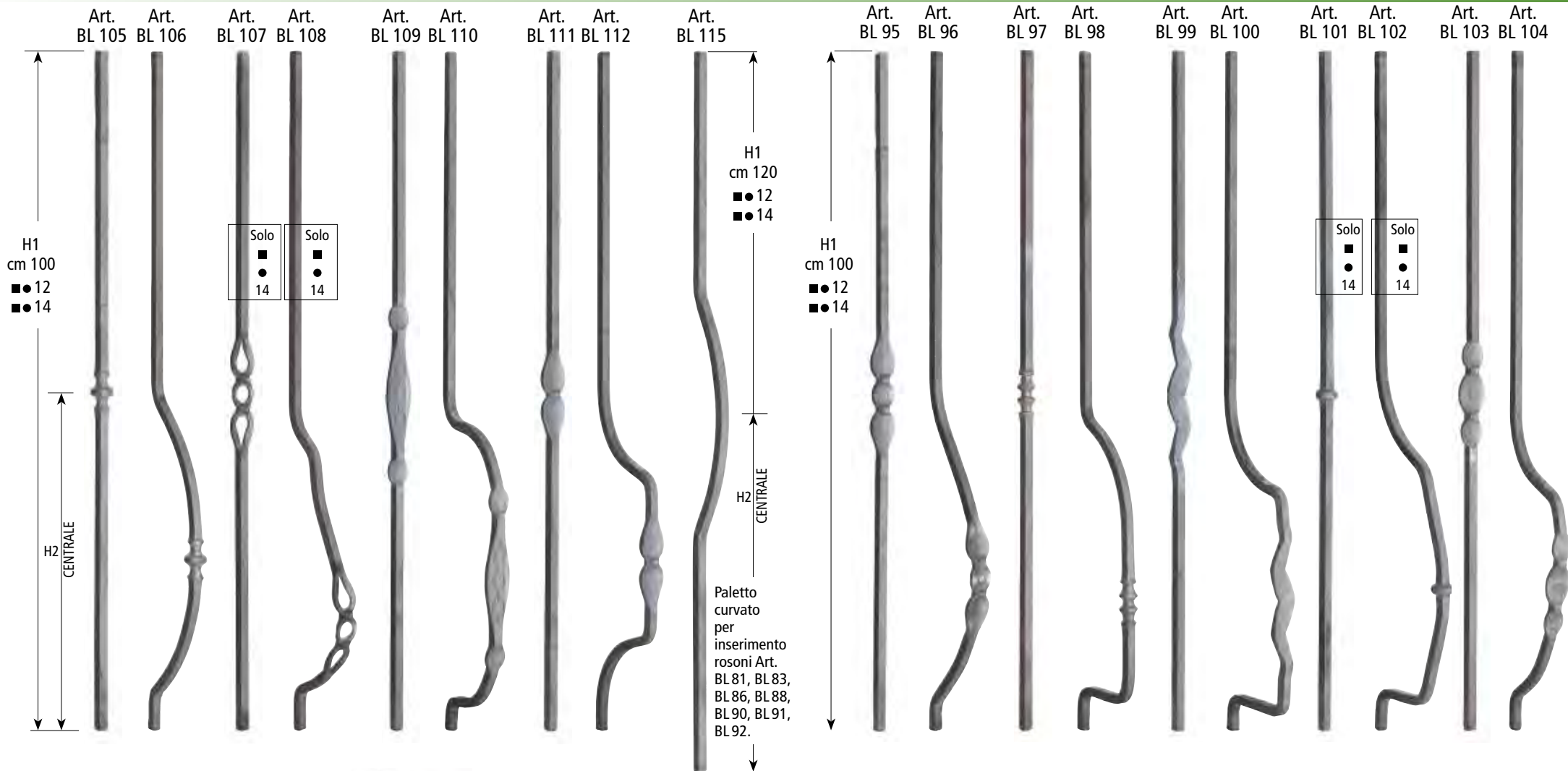

Tutte le decorazioni vengono eseguite anche con profili battuti.

VERTICALI DECORATIVI PER RINGHIERE AD ALTEZZA RIDOTTA

DECORATIVE STAKES FOR BALUSTRADES LOWER

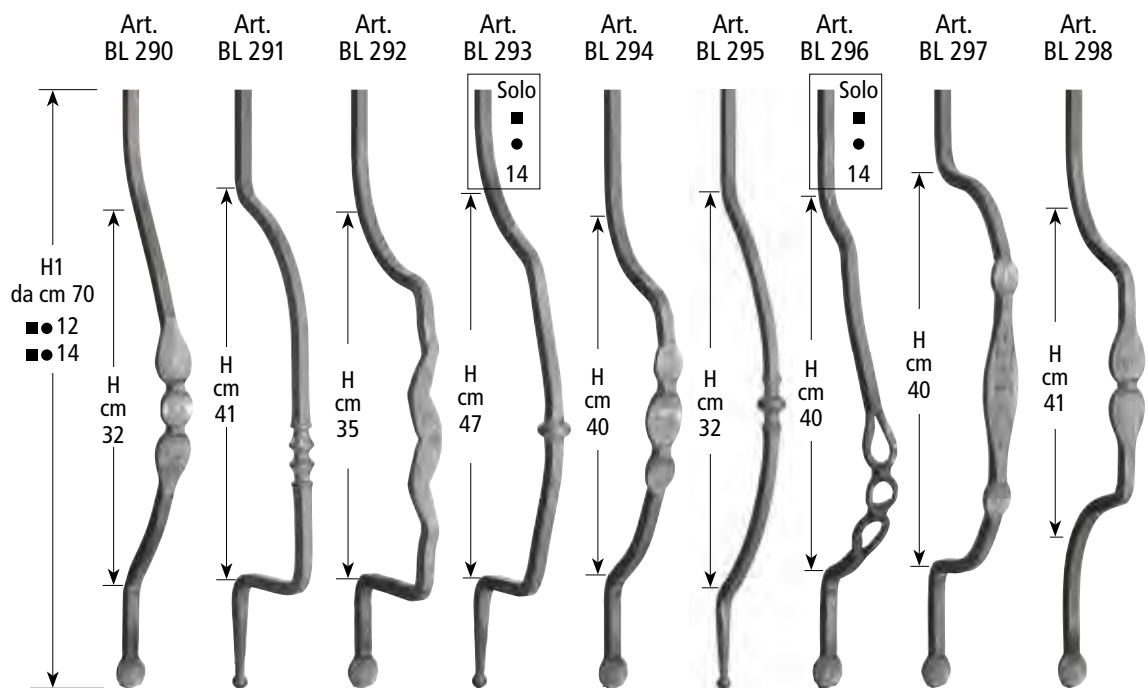

Tutte le decorazioni vengono eseguite anche con profili battuti.

VERTICALI DECORATIVI PER SCALE E BALCONI

DECORATIVE STAKES FOR STAIRCASES AND BALUSTRADES

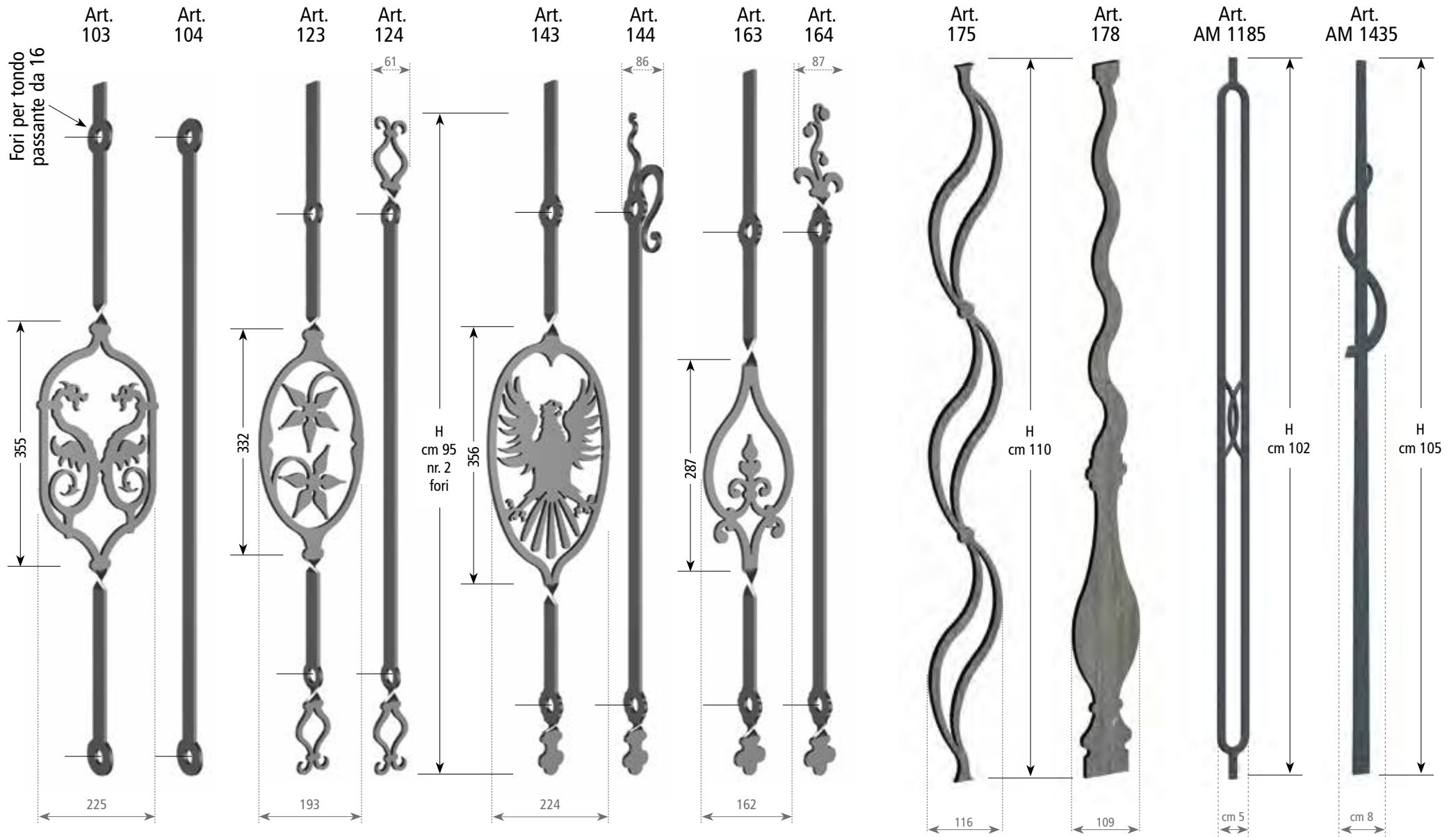

PER L'ORDINAZIONE DEI VERTICALI DECORATIVI E' NECESSARIO TRASMETTERE L'ARTICOLO E IL TIPO DI FORO:
 - FORO TONDO PER PARAPETTI DIRITTI;
 - FORO OVALE PER SCALE.

SI FORNISCONO SOLO LISCI - SPESSORE MM 6

VERTICALI DECORATIVI PER SCALE E BALCONI

DECORATIVE STAKES FOR STAIRCASES AND BALUSTRADES



corrimano Art. BL 122
cm 300-600

ricciolo terminale
Art. BL 124

profilo 50x14
45x12
40x11

Art. AM 1015 Art. AM 1105 Art. AM 1115

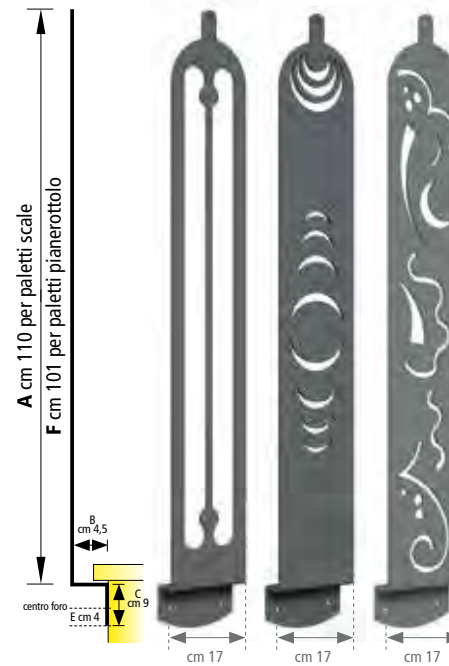

spessore mm 6
Grezzo

Art. AM 1104
spessore mm 1



Grezzo
STAFFA per fissaggio
su corrimano in legno
tondo d. mm 50

Art. AM 1014
spessore mm 1

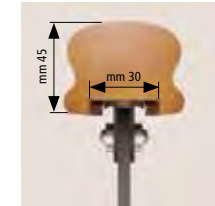

Grezzo
STAFFA per fissaggio
su corrimano in legno
sagomato - incastro mm 30

Art. AM 1235 Art. AM 1245 Art. AM 1265 Art. AM 1325

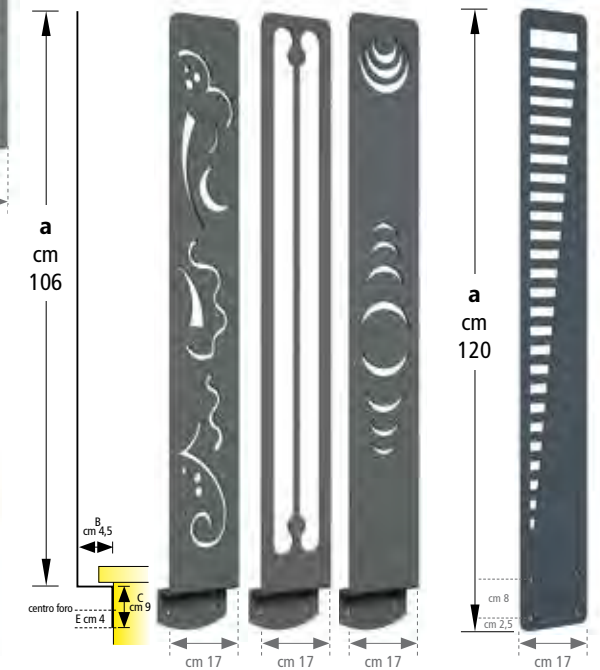

spessore mm 6
Grezzo

SI FORNISCONO SOLO LISCI - SPESSORE MM 6

VERTICALI DECORATIVI PER SCALE E BALCONI

DECORATIVE STAKES FOR STAIRCASES AND BALUSTRADES

Art.
AM 1655



Art.
AM 1656



Art.
AM 1695



Art.
AM 1695
portafiori



Per facilitare l'ordinazione degli Artt.:
AM1655/AM1656/AM1665/AM1675/
AM1685/AM1685PORTAFIORI/
AM1686/AM1695/AM1695
PORTAFIORI/AM1705/AM1705
PORTAFIORI,

è sufficiente trasmettere le misure richieste nello schema qui riportato (H;L;D;A;S).

Dimensione fori per fissaggio SU RICHIESTA.

Vi saranno forniti i verticali decorativi in materiale GREZZO e SU MISURA. (Accessori SU RICHIESTA)

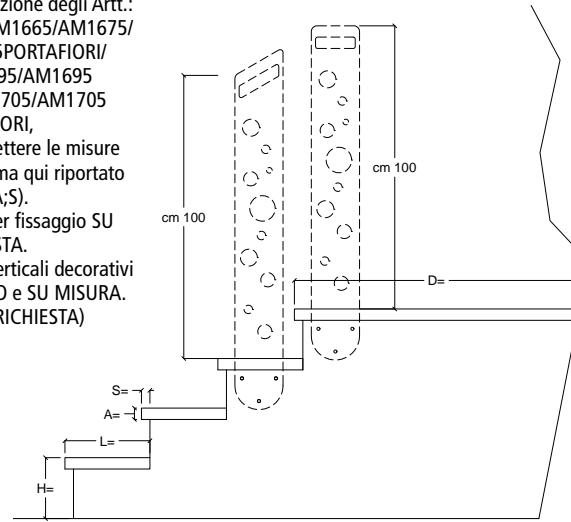

Art.
AM 1675



Art.
AM 1686



Art.
AM 1685



Art.
AM 1685
portafiori



Art.
AM 1665



Art.
AM 1705



Art.
AM 1705
portafiori



PANNELLI DECORATIVI PER SCALE E BALCONI

METAL SHEET FOR STAIRCASES AND BALUSTRADES

ART. AM 1026
spessore mm 4



ART. AM 1025
spessore mm 4



ART. AM 1146
spessore mm 4



ART. AM 1145
spessore mm 4



FASCE DECORATIVE PANTOGRAFATE

SHEET METAL MOTIFS

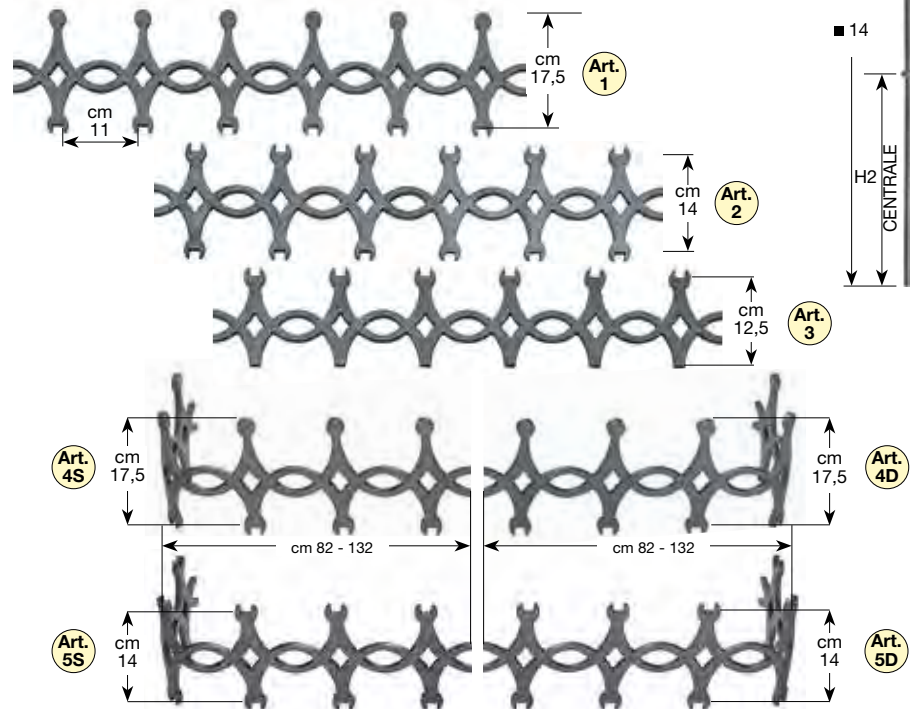
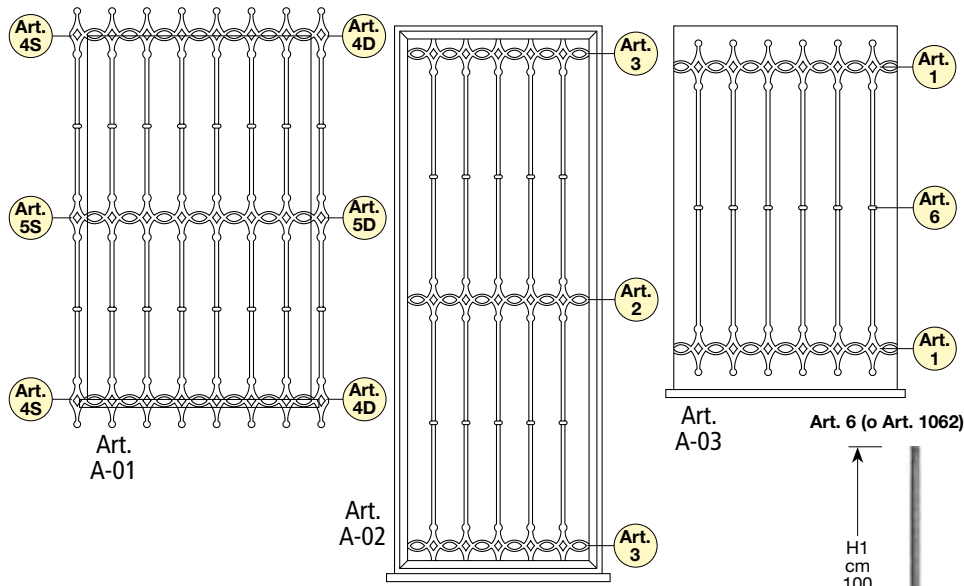

Art. 1 - 2 - 3 da cm 100 - 150 - 200 spessore mm 10.
 Art. 4S - 4D - 5S - 5D - da cm 100 - 150 spessore mm 10. Vengono forniti piegati su un lato.

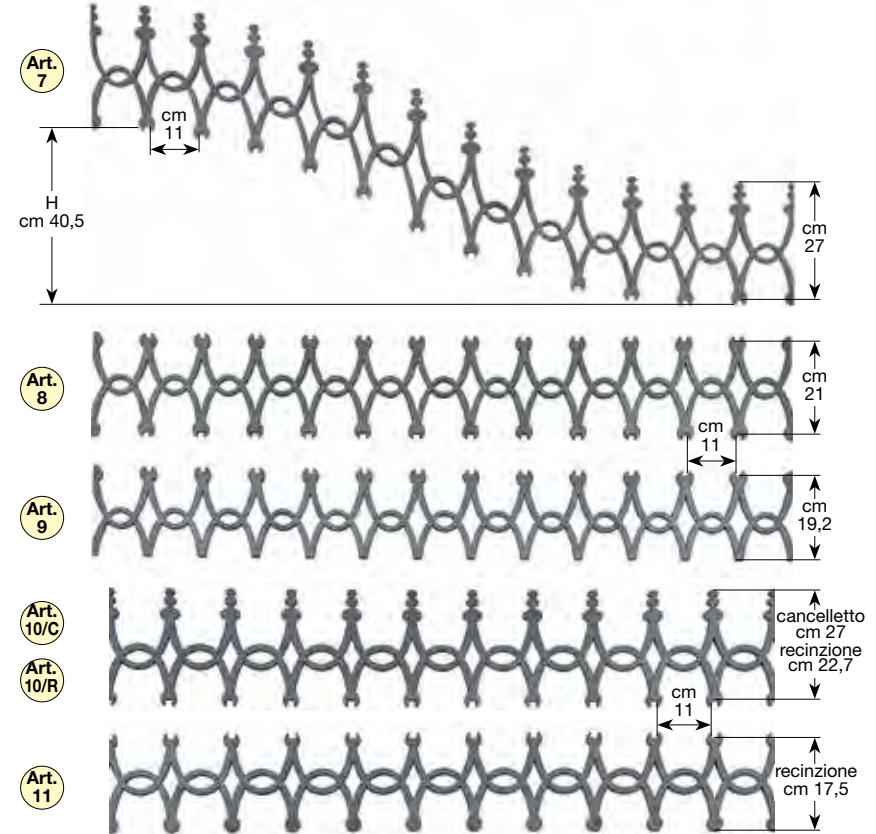
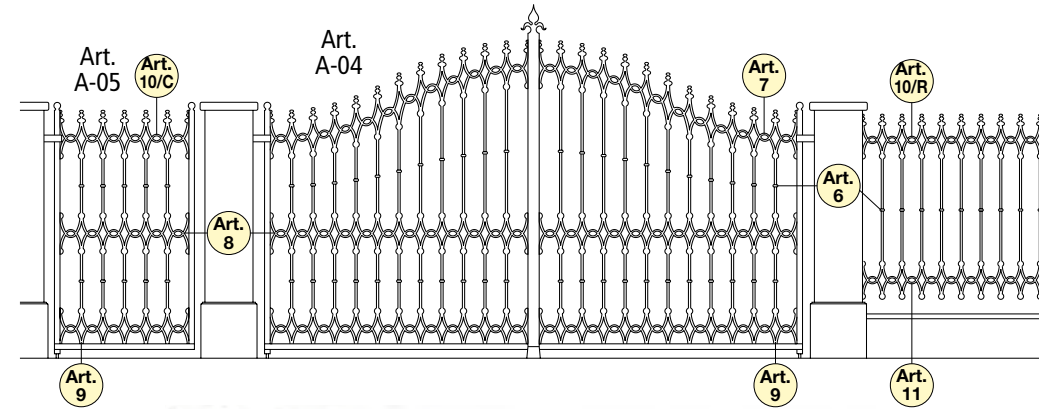

Art. 7 da cm 200 - 250 spessore mm 10. Art. 8 - 9 da cm 100 - 150 - 200 - 250 spessore mm 10.
 Art. 10 - 11 da cm 100 - 150 - 200 spessore mm 10.

FASCE DECORATIVE PANTOGRAFATE

SHEET METAL MOTIFS

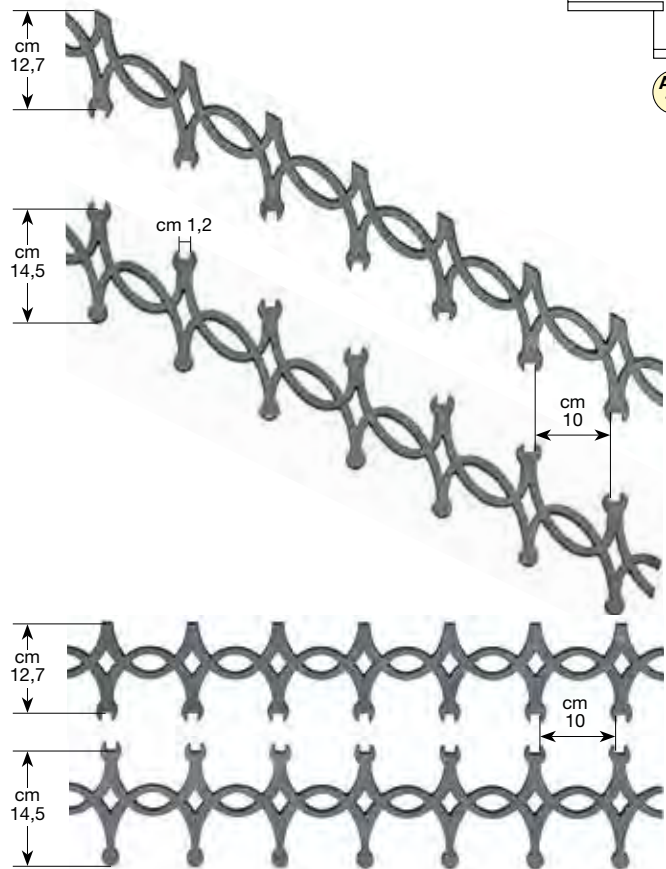
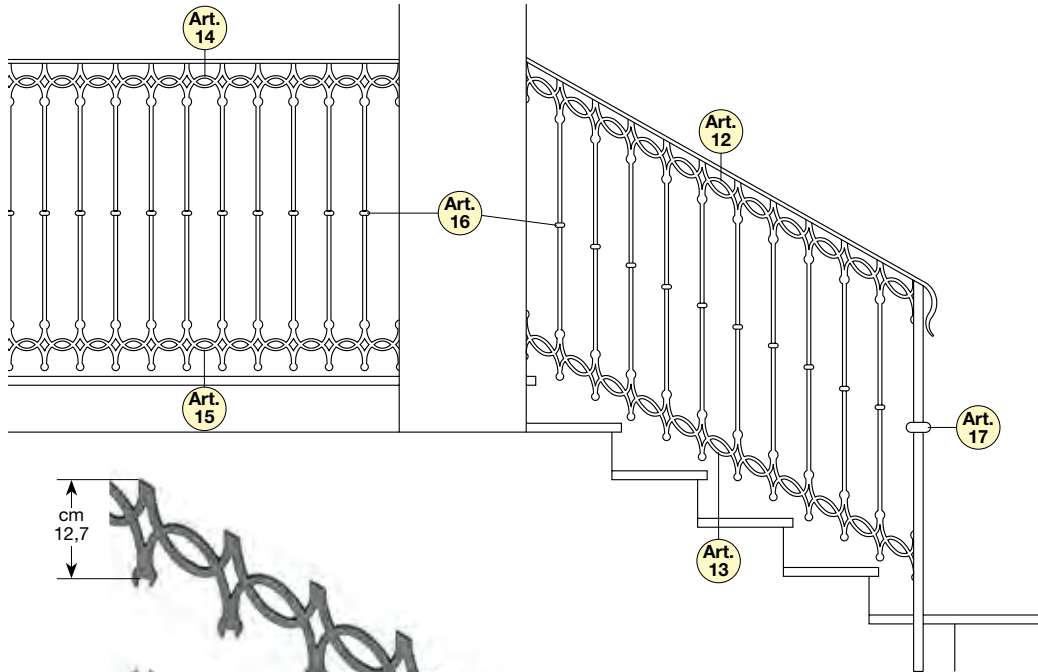

Art. 12 - 13 - 14 - 15 da cm 100 - 150 - 200 spessore mm 10.

Art. 17 (o Art. 1076)

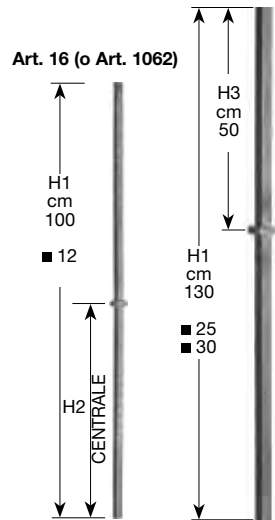

Art. 16 (o Art. 1062)

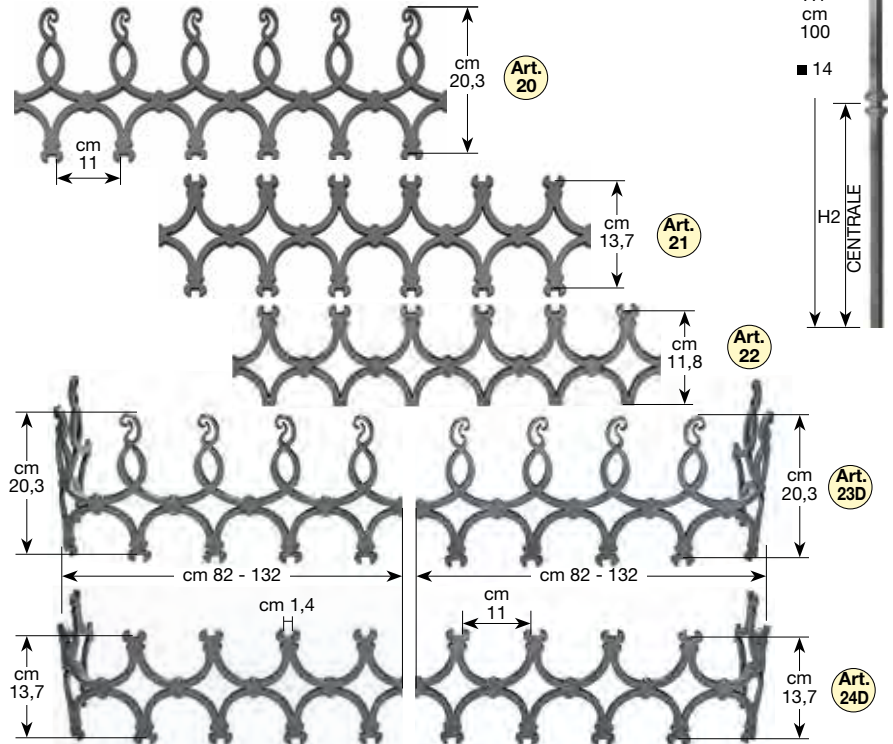
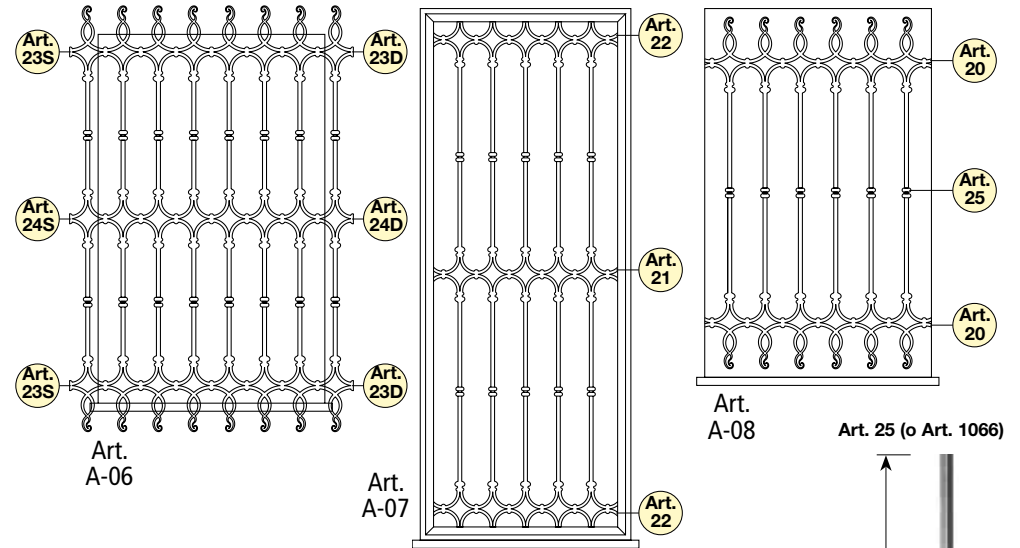

Art. 20 - 21 - 22 da cm 100 - 150 - 200 spessore mm 10.
Art. 23D - 23S - 24D - 24S - da cm 100 - 150 spessore mm 10. Vengono forniti piegati su un lato.

FASCE DECORATIVE PANTOGRAFATE

SHEET METAL MOTIFS

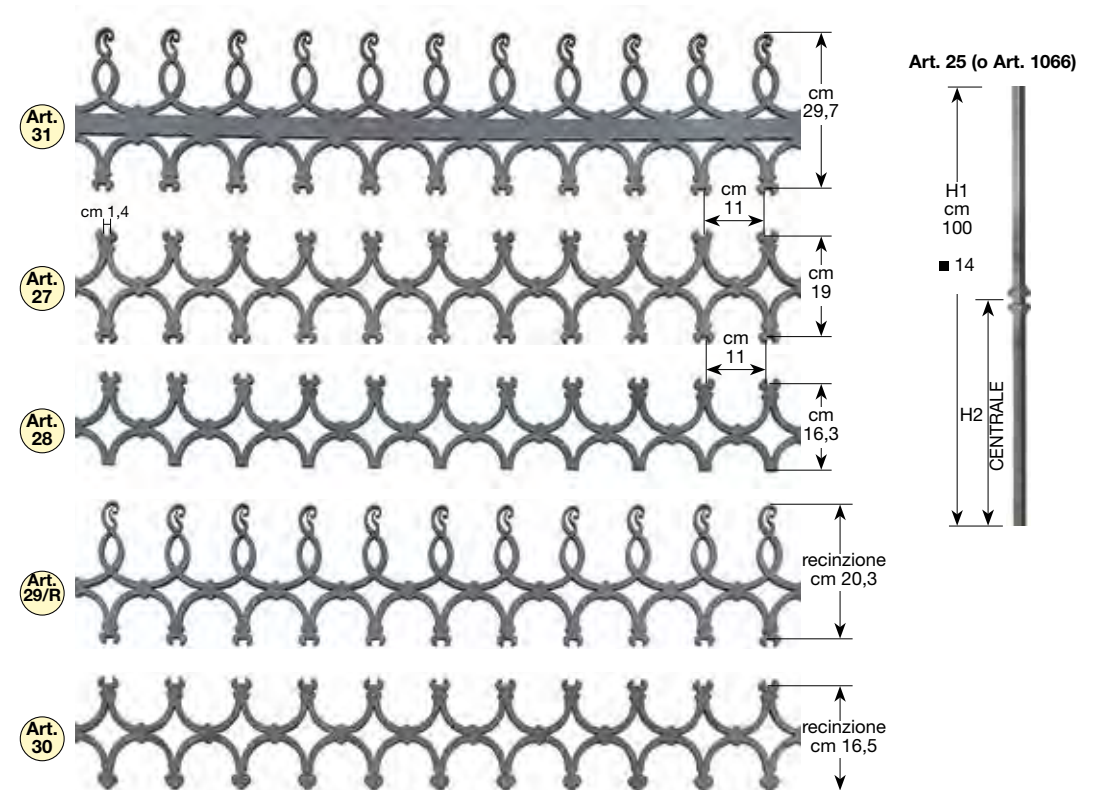
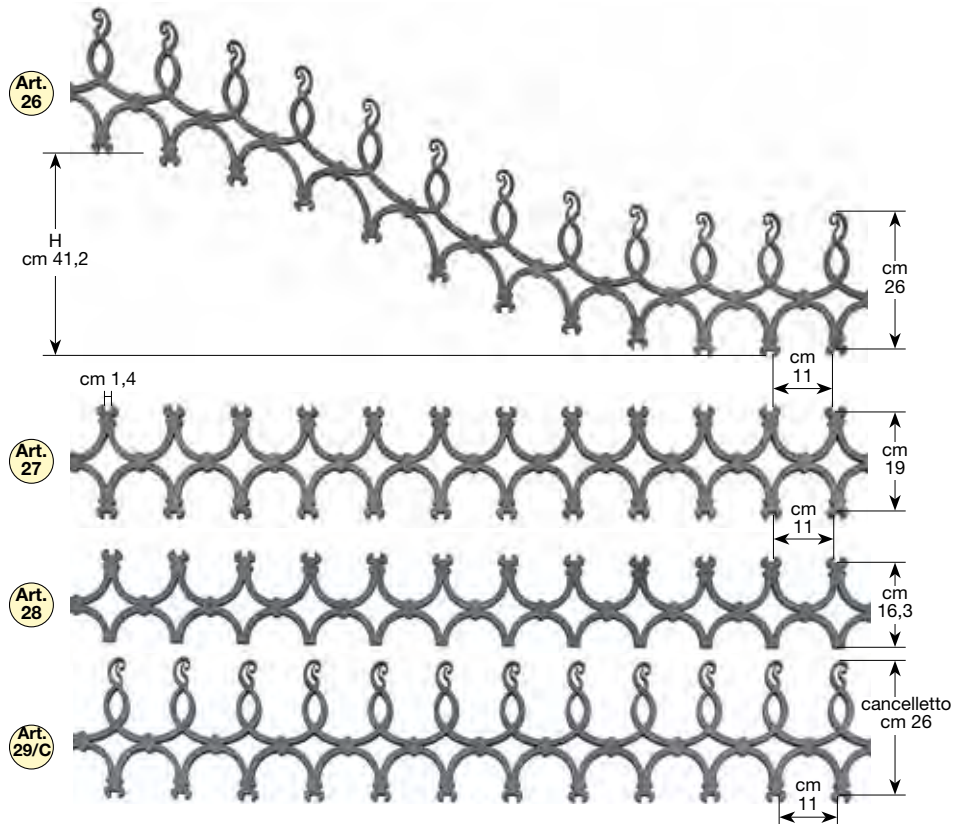
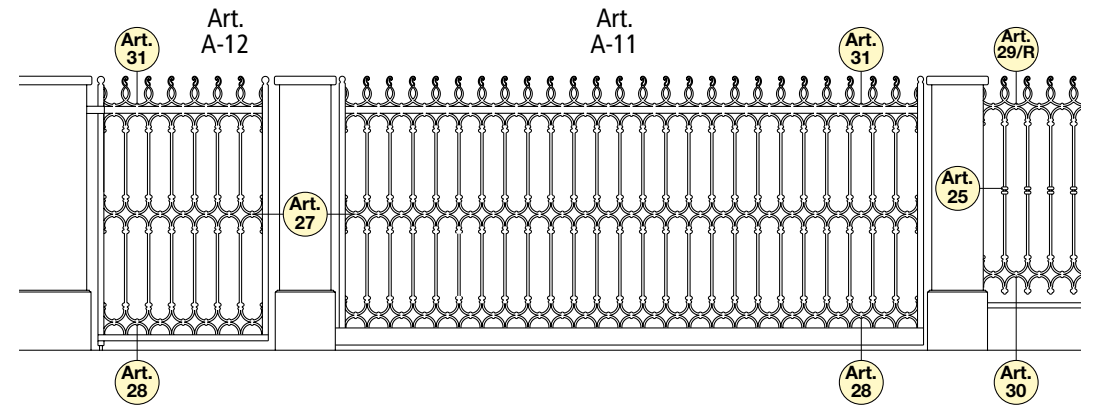
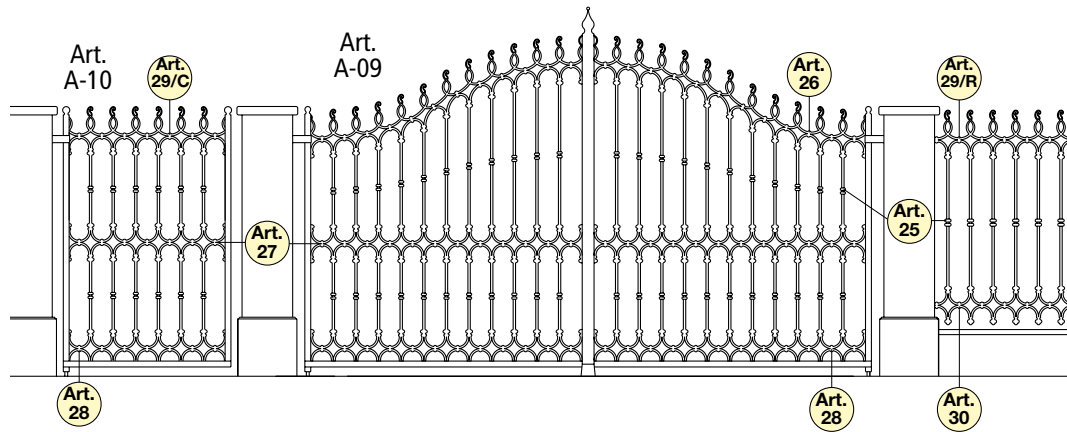

Art. 26 da cm 200 - 250 spessore mm 10. Art. 27 - 28 da cm 100 - 150 - 200 - 250 spessore mm 10.
 Art. 29 - 30 da cm 100 - 150 - 200 spessore mm 10. Art. 31 da cm 100 - 150 - 200 - 250 spessore mm 10.

FASCE DECORATIVE PANTOGRAFATE

SHEET METAL MOTIFS

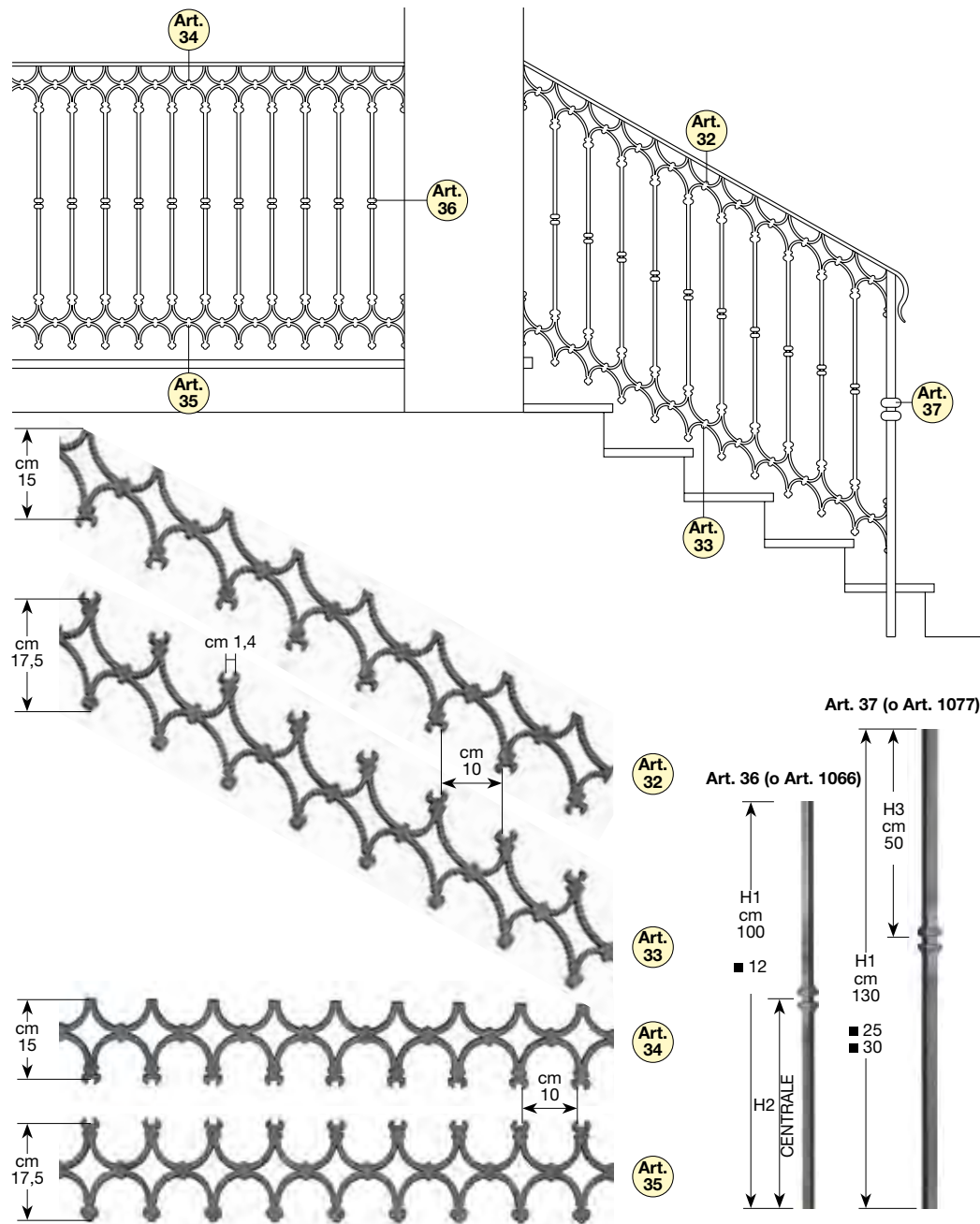

Art. 32 - 33 - 34 - 35 da cm 100 - 150 - 200 spessore mm 10.

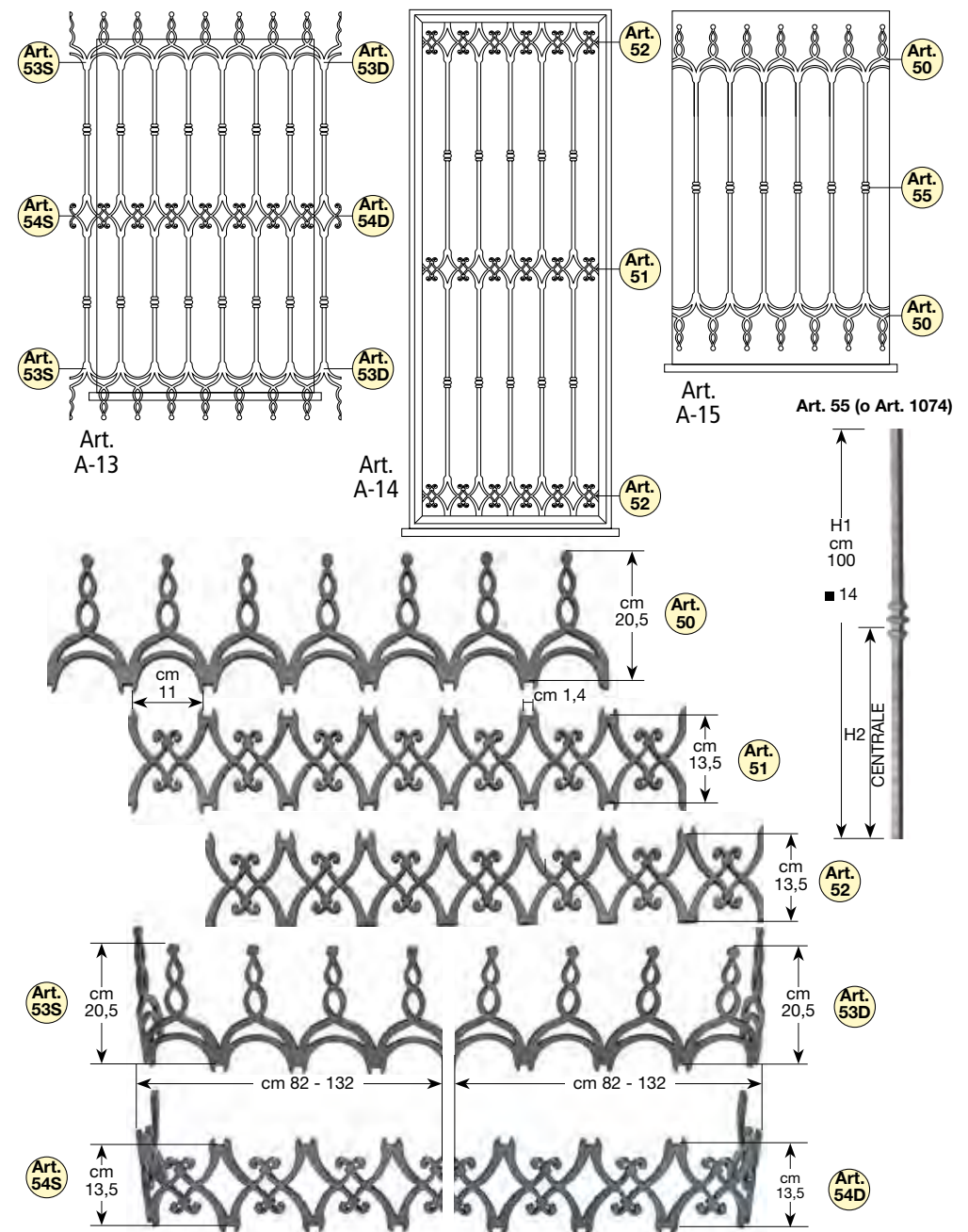

Art. 50 - 51 - 52 da cm 100 - 150 - 200 spessore mm 10.
Art. 53D - 53S - 54D - 54S - da cm 100 - 150 spessore mm 10. Vengono forniti piegati su un lato.

FASCE DECORATIVE PANTOGRAFATE

SHEET METAL MOTIFS

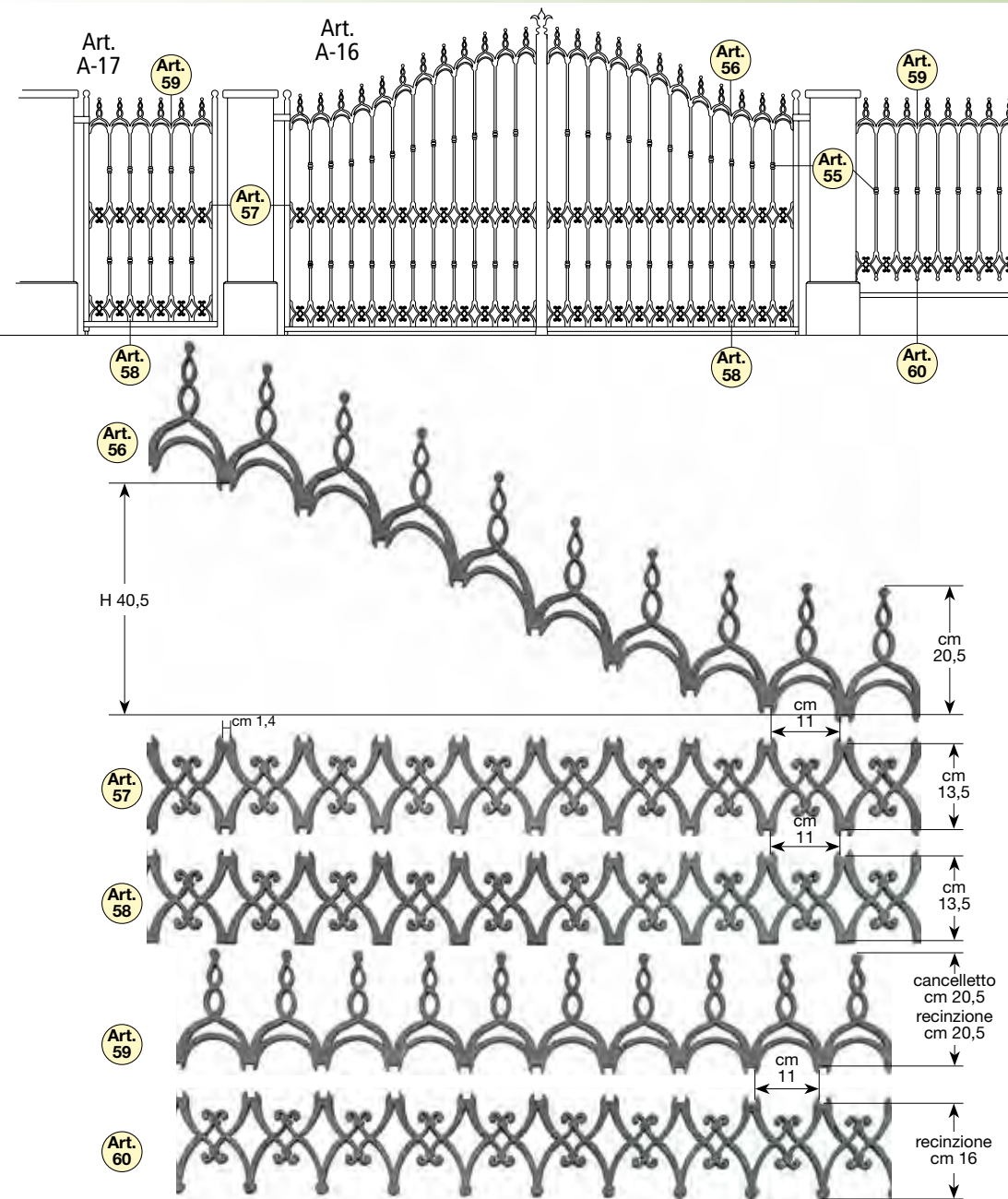

Art. 56 da cm 200 - 250 spessore mm 10. Art. 57 - 58 da cm 100 - 150 - 200 - 250 spessore mm 10.
Art. 59 - 60 da cm 100 - 150 - 200 spessore mm 10.

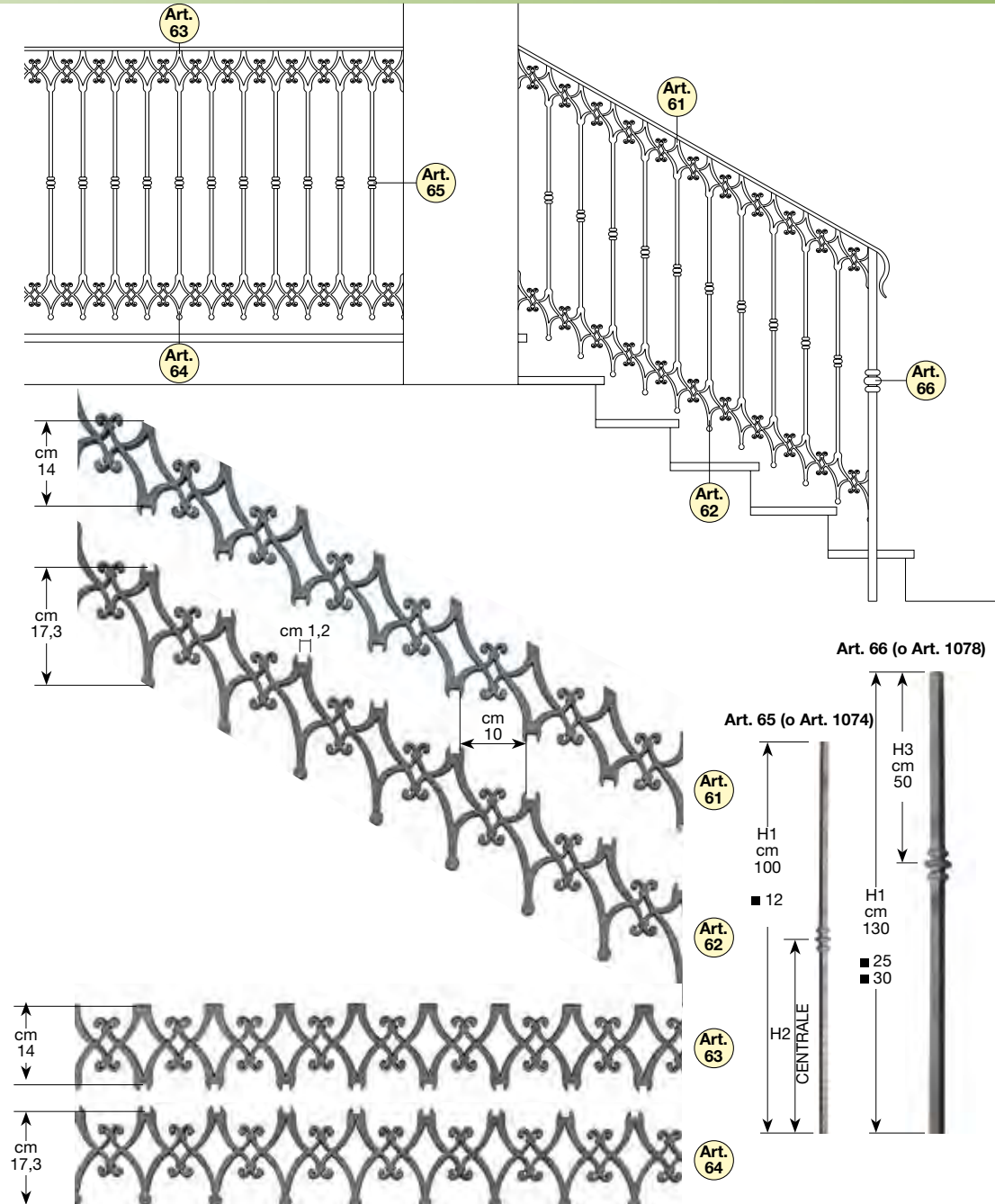

Art. 61 - 62 - 63 - 64 da cm 100 - 150 - 200 spessore mm 10.

FASCE DECORATIVE PANTOGRAFATE

SHEET METAL MOTIFS

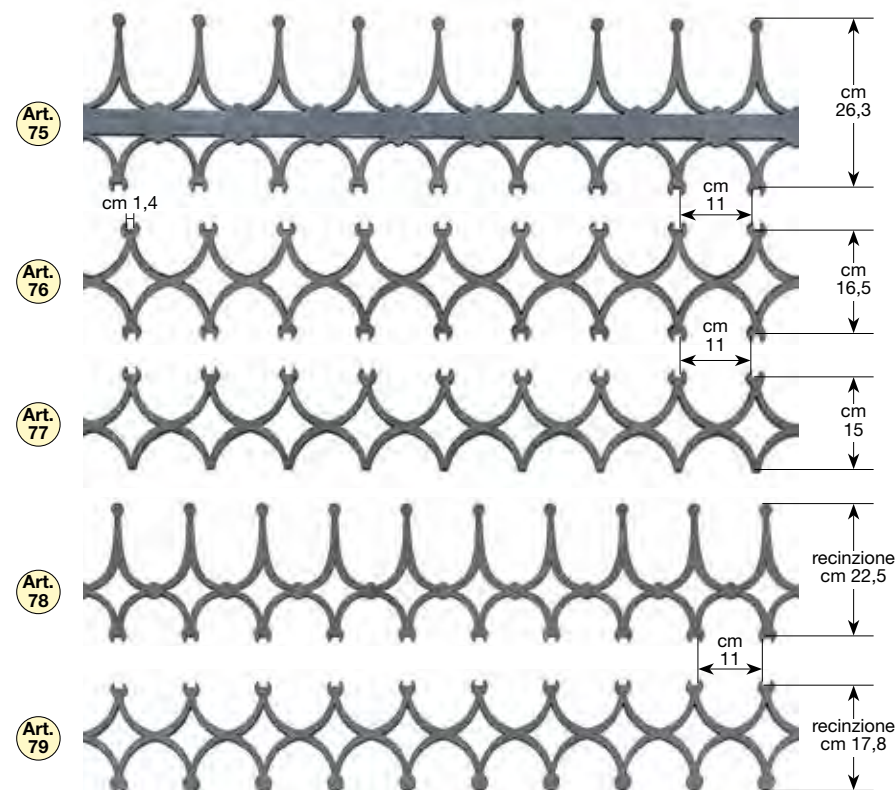
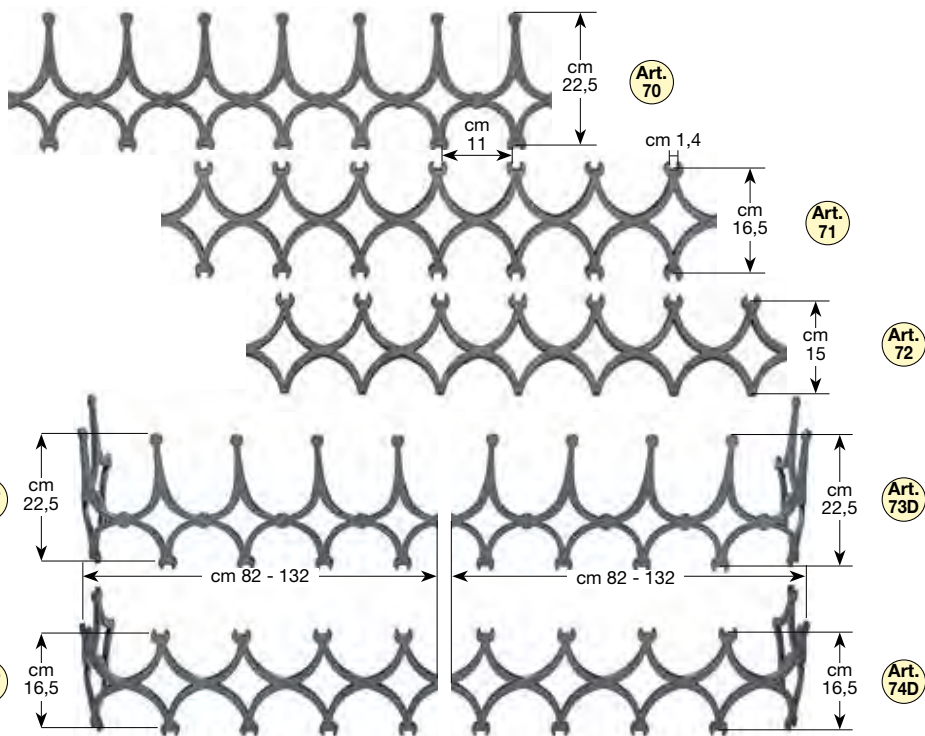
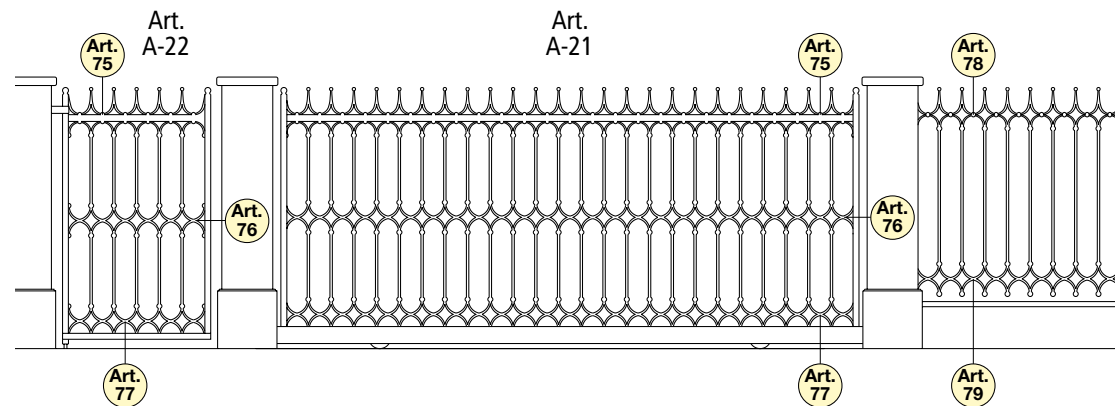
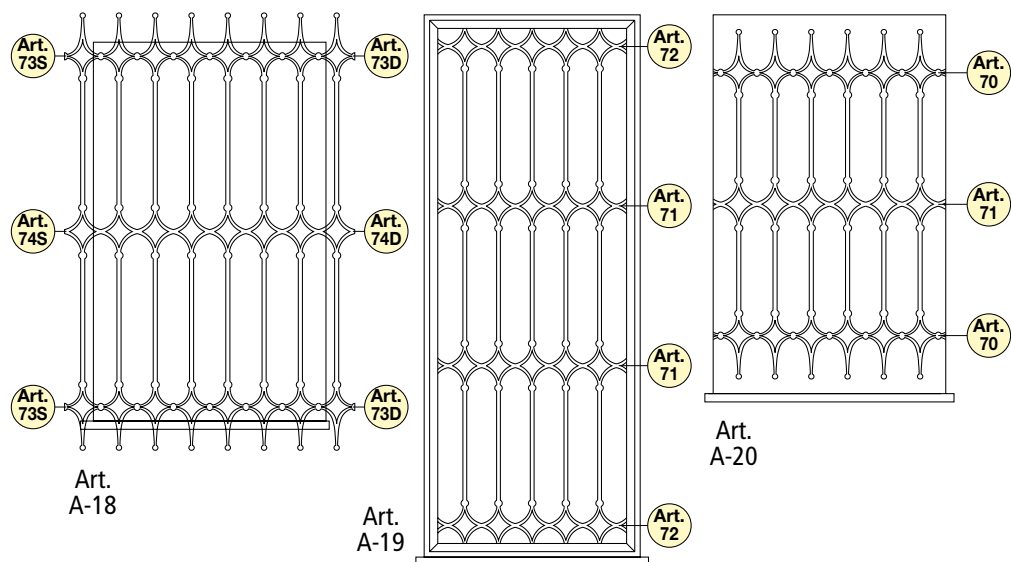

Art. 70 - 71 - 72 da cm 100 - 150 - 200 spessore mm 10.
 Art. 73D - 73S - 74D - 74S da cm 100 - 150 spessore mm 10. Vengono forniti piegati su un lato.

Art. 75 da cm 100 - 150 - 200 - 250 spessore mm 10.
 Art. 76 - 77 da cm 100 - 150 - 200 - 250 spessore mm 10.
 Art. 78 - 79 da cm 100 - 150 - 200 spessore mm 10.

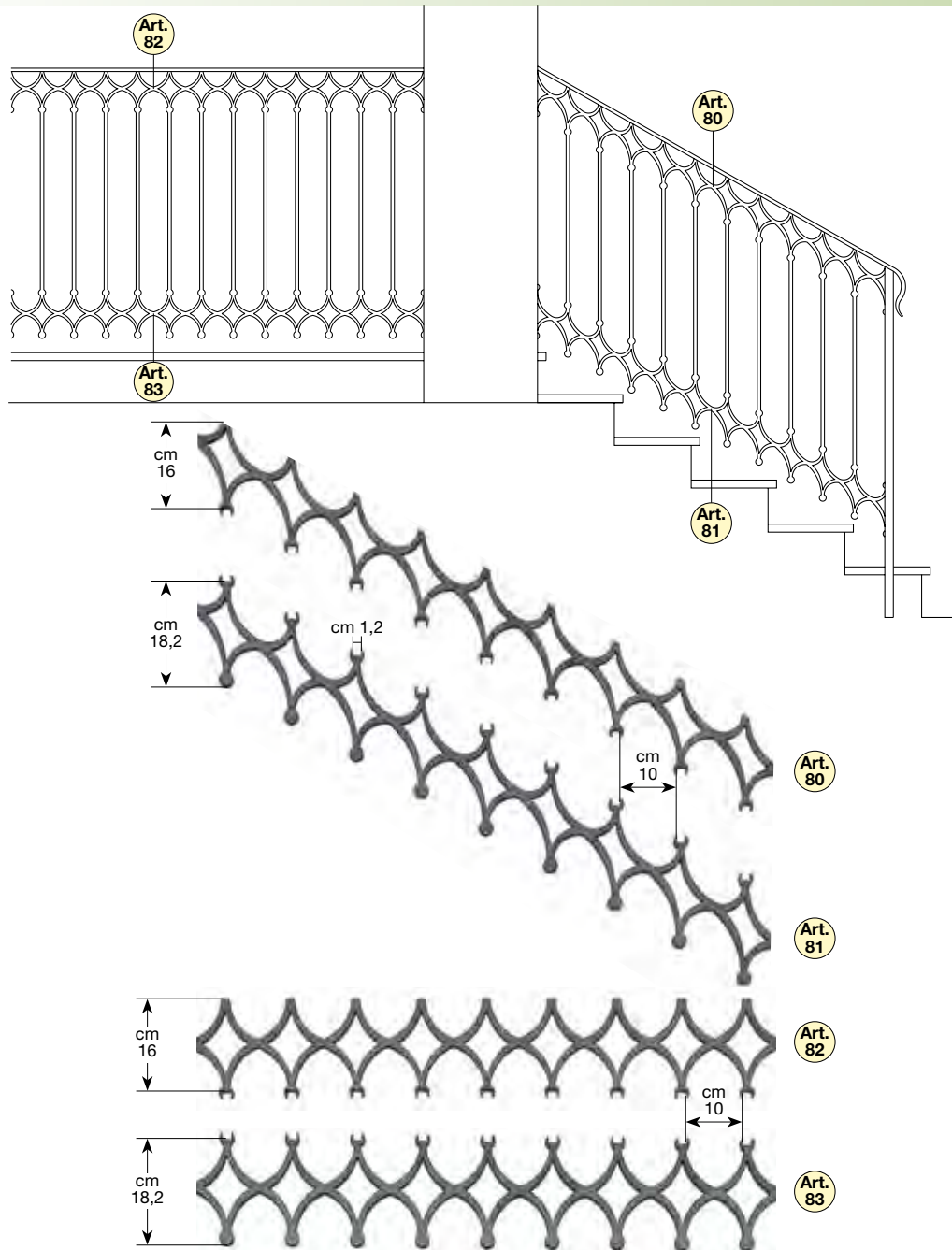

Art. 80 - 81 - 82 - 83 da cm 100 - 150 - 200 spessore mm 10.

ROSONI DECORATIVI PER INFERRIATE, SCALE E CANCELLI

DECORATIVE ROSETTES FOR RAILINGS, STAIRS AND GATES

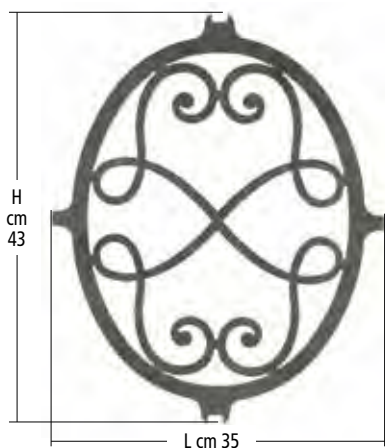

Art. BL 81

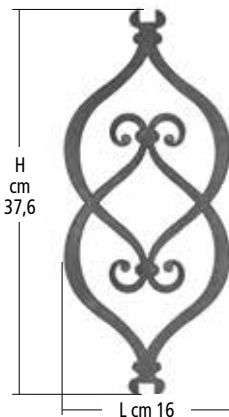

Art. BL 82

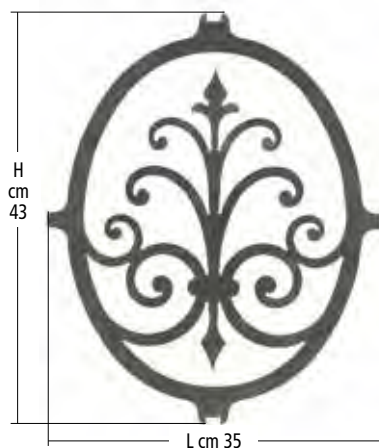

Art. BL 83

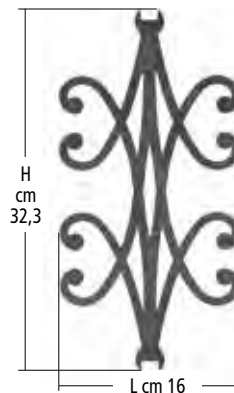

Art. BL 84

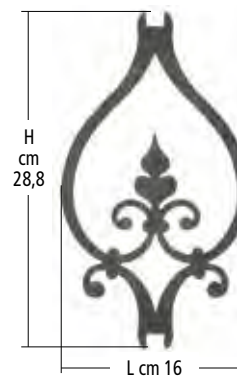

Art. BL 85

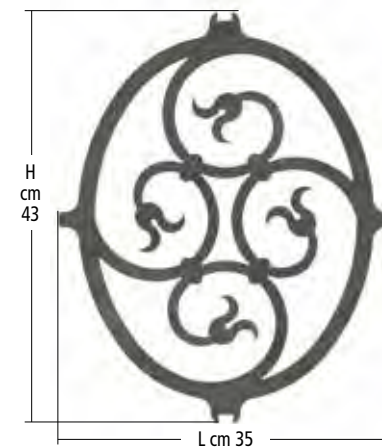

Art. BL 86

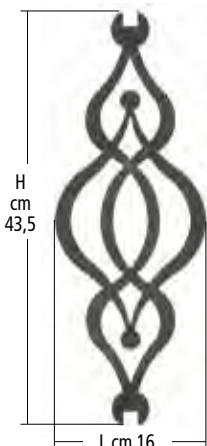

Art. BL 87

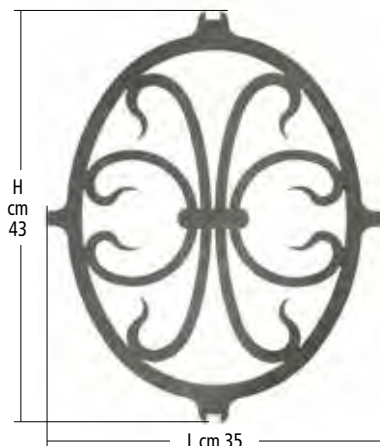

Art. BL 88

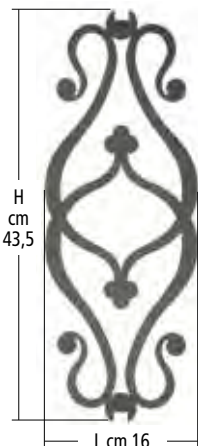

Art. BL 89

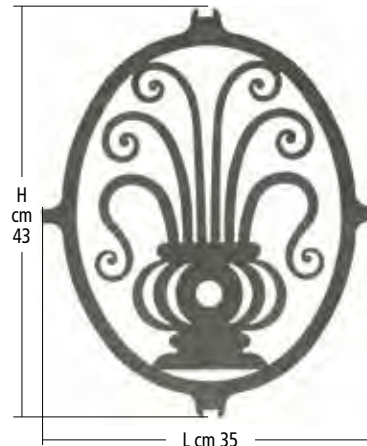

Art. BL 90

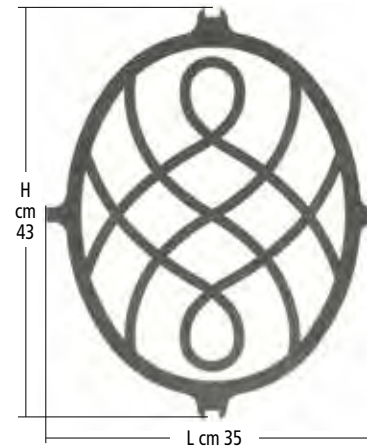

Art. BL 91

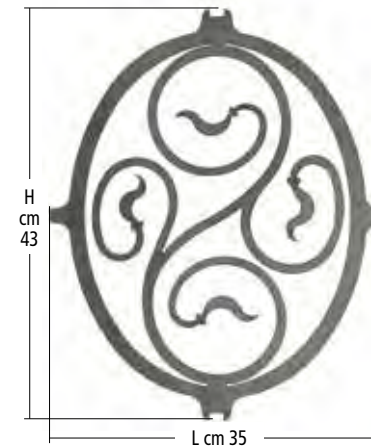

Art. BL 92

Tutti i rosoni sono di spessore 4, 6 e 8 mm e si forniscono solo in materiale liscio.

Si consiglia di utilizzare lo spessore di 6 mm per inferrate, scale e poggiali e lo spessore di 8 mm per cancelli e recinzioni.



Art. D10
sp. mm 6

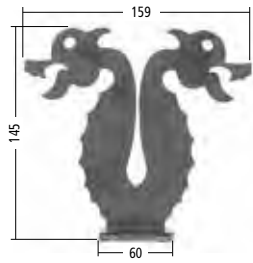

Art. D11
sp. mm 6



Art. D12
sp. mm 6



ESEMPIO



Art. D24
sp. mm 6



Art. F104
sp. mm 6



Art. D30
sp. mm 3 / sp. mm 4



Art. D13
sp. mm 6



Art. D14
sp. mm 6



Art. D15
sp. mm 6



Art. D31
sp. mm 3 / sp. mm 4

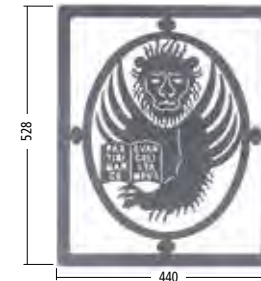

Art. D32
sp. mm 3 / sp. mm 4



Art. D33
sp. mm 3 / sp. mm 4



Art. D16
sp. mm 6

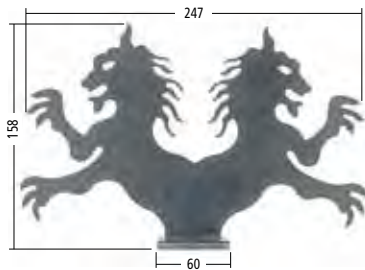

Art. D17
sp. mm 6

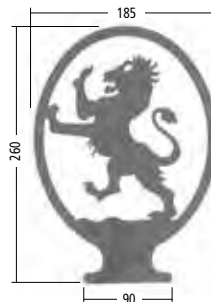

Art. F103
sp. mm 6



Art. D34
sp. mm 3 / sp. mm 4



Art. D35
sp. mm 3 / sp. mm 4

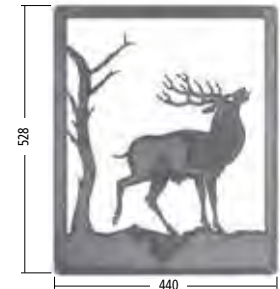

Art. D36
sp. mm 3 / sp. mm 4



Art. D21
sp. mm 6



Art. D22
sp. mm 6

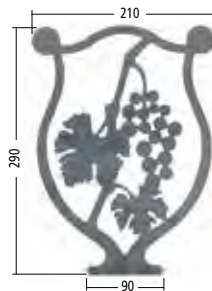

Art. D23
sp. mm 6



Art. D37
sp. mm 3 / sp. mm 4



Art. D38
sp. mm 3 / sp. mm 4



Art. D39
sp. mm 3 / sp. mm 4

SI CREANO DECORI PERSONALIZZATI

CUSTOM DESIGNS

DECORI "LO ZODIACO"



DECORI PER ARTE SACRA

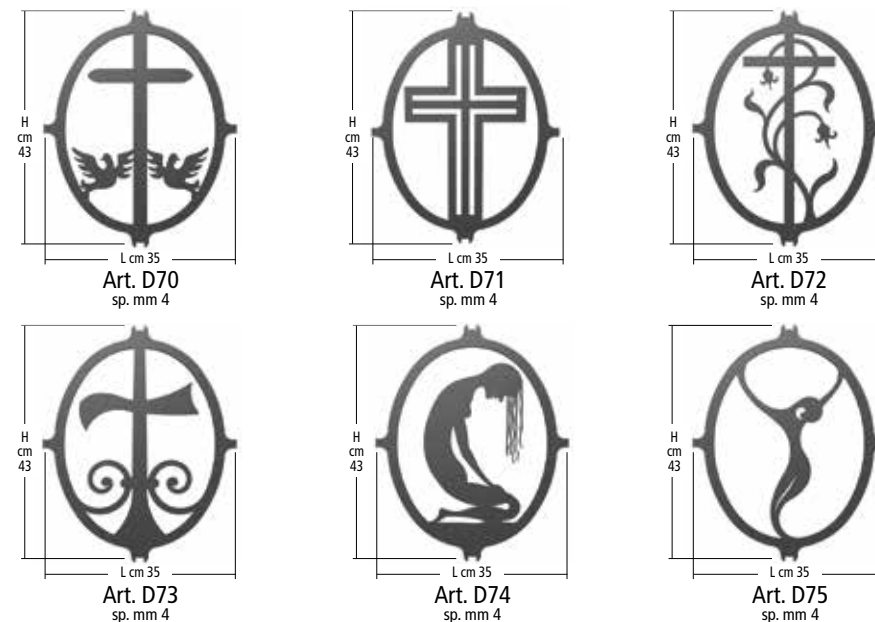

DECORI VARI

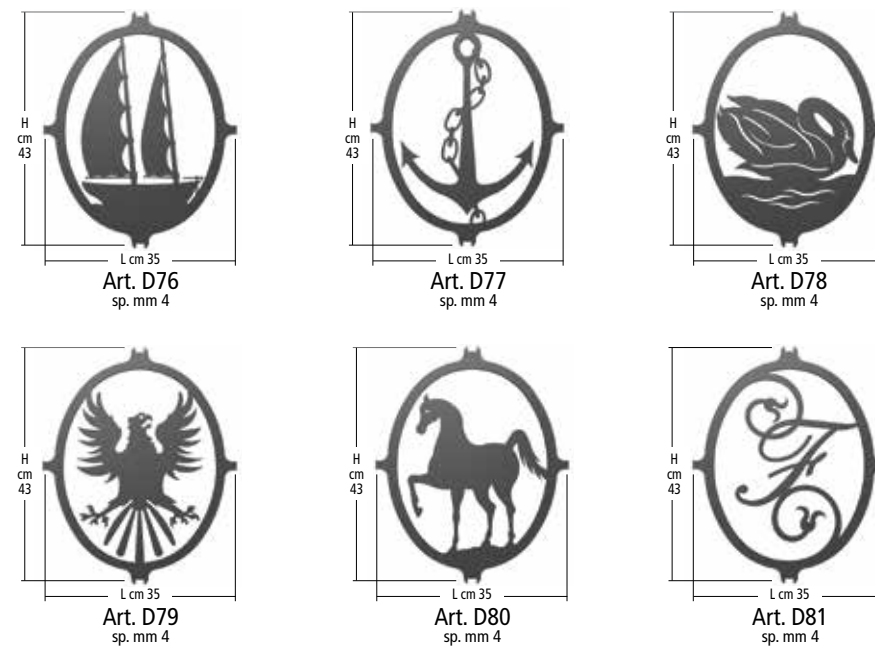

DECORI VARI

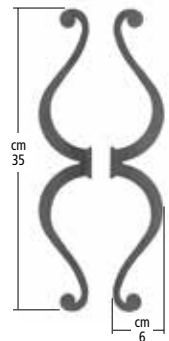

Art. F90
sp. mm 3
sp. mm 4

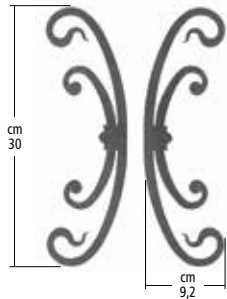

Art. F91
sp. mm 3
sp. mm 4

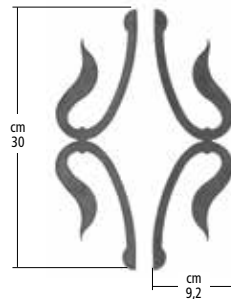

Art. F92
sp. mm 3
sp. mm 4

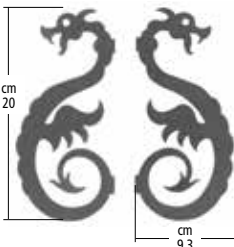

Art. F93
sp. mm 3
sp. mm 4

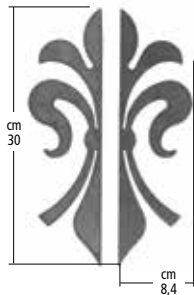

Art. F94
sp. mm 3
sp. mm 4

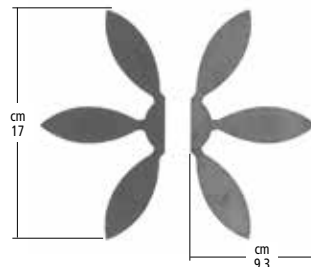

Art. F95
sp. mm 3
sp. mm 4

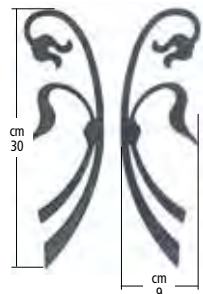

Art. F96
sp. mm 3
sp. mm 4

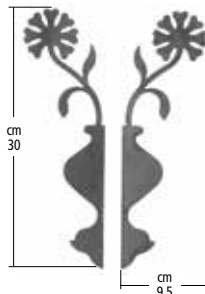

Art. F97
sp. mm 3
sp. mm 4

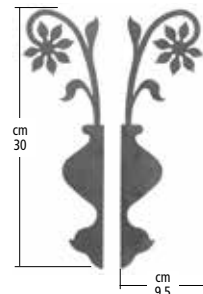

Art. F98
sp. mm 3
sp. mm 4

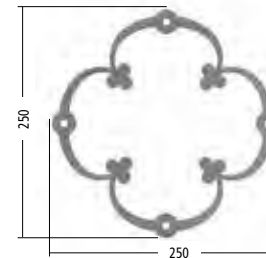

Art. D2
sp. mm 6

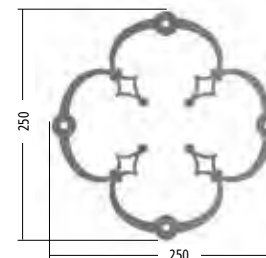

Art. D3
sp. mm 6

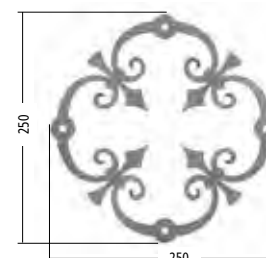

Art. D6
sp. mm 6

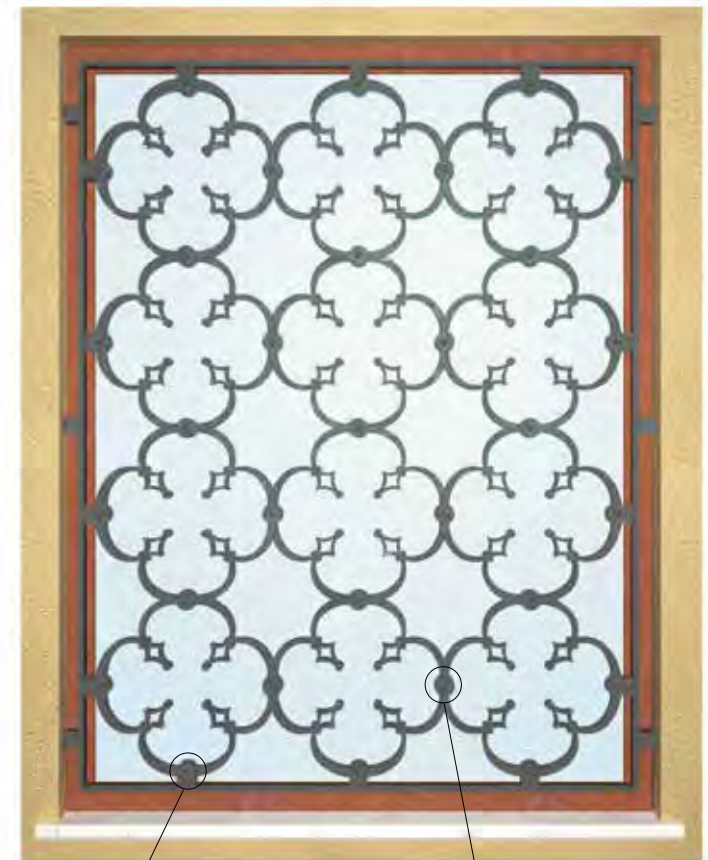

Art. BL 319 da 115x30x4
staffa di fissaggio



ribattino
20x8

Su richiesta spessore e misure diverse.

Nel listino i prezzi sono riferiti al singolo pezzo.

RICCIOLI DECORATIVI, FASCETTE, COPRIPILASTRI E RIBATTINI

DECORATIVE CURLS, CLIPS, POST TOPS, RIVETS

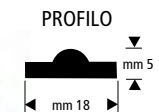
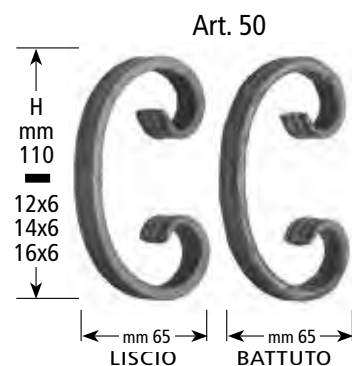
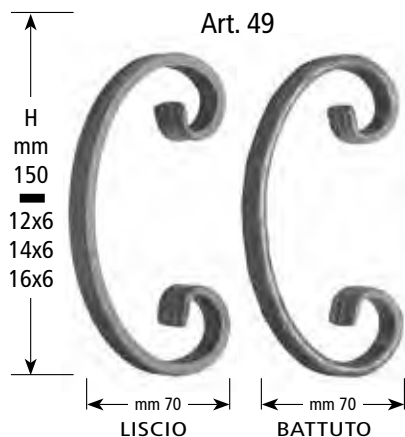
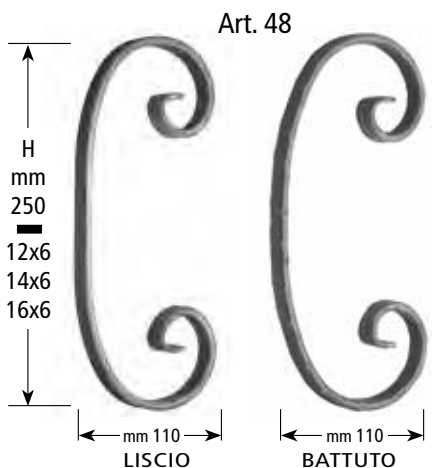
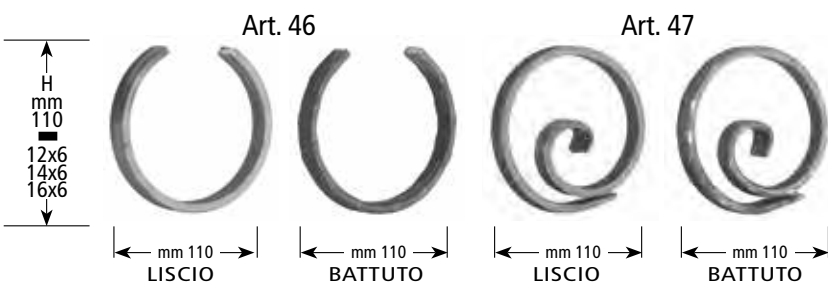
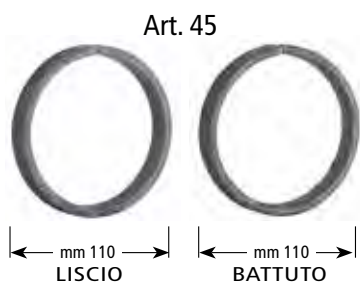
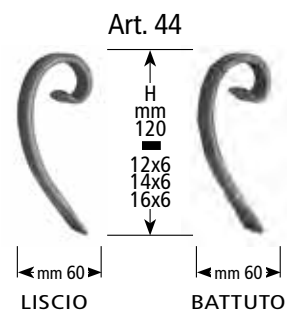
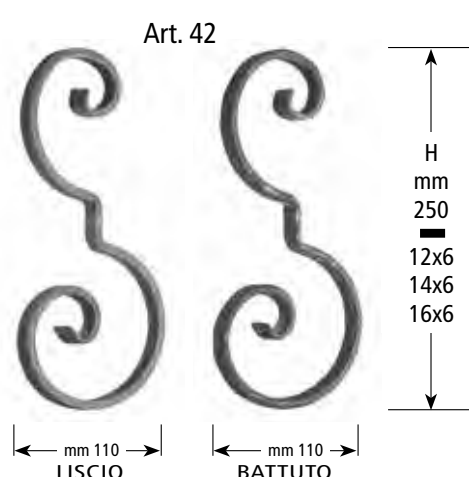
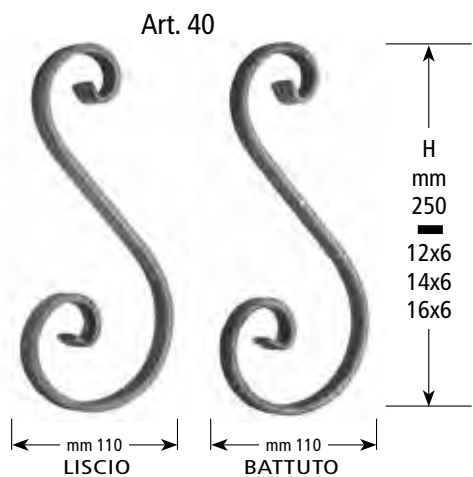

- PER QUADRI E PIATTI:
- n.1 ■ 12 + n.2 ■ 12x6
 - n.1 ■ 14 + n.2 ■ 14x6
 - n.1 ■ 16 + n.2 ■ 16x6
 - n.1 ■ 12 + n.1 ■ 12x6
 - n.1 ■ 14 + n.1 ■ 14x6
 - n.1 ■ 16 + n.1 ■ 16x6

Art. 350

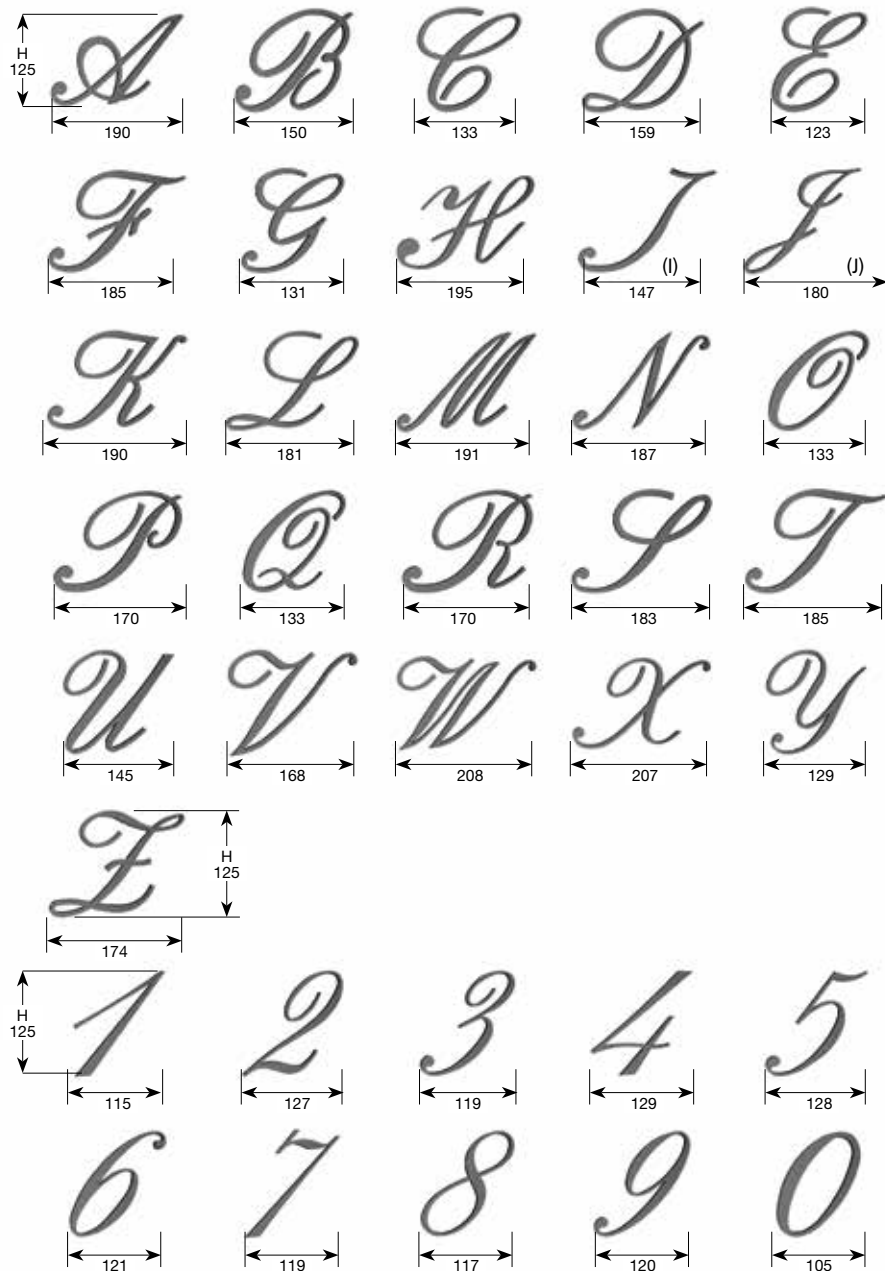

Art. 360

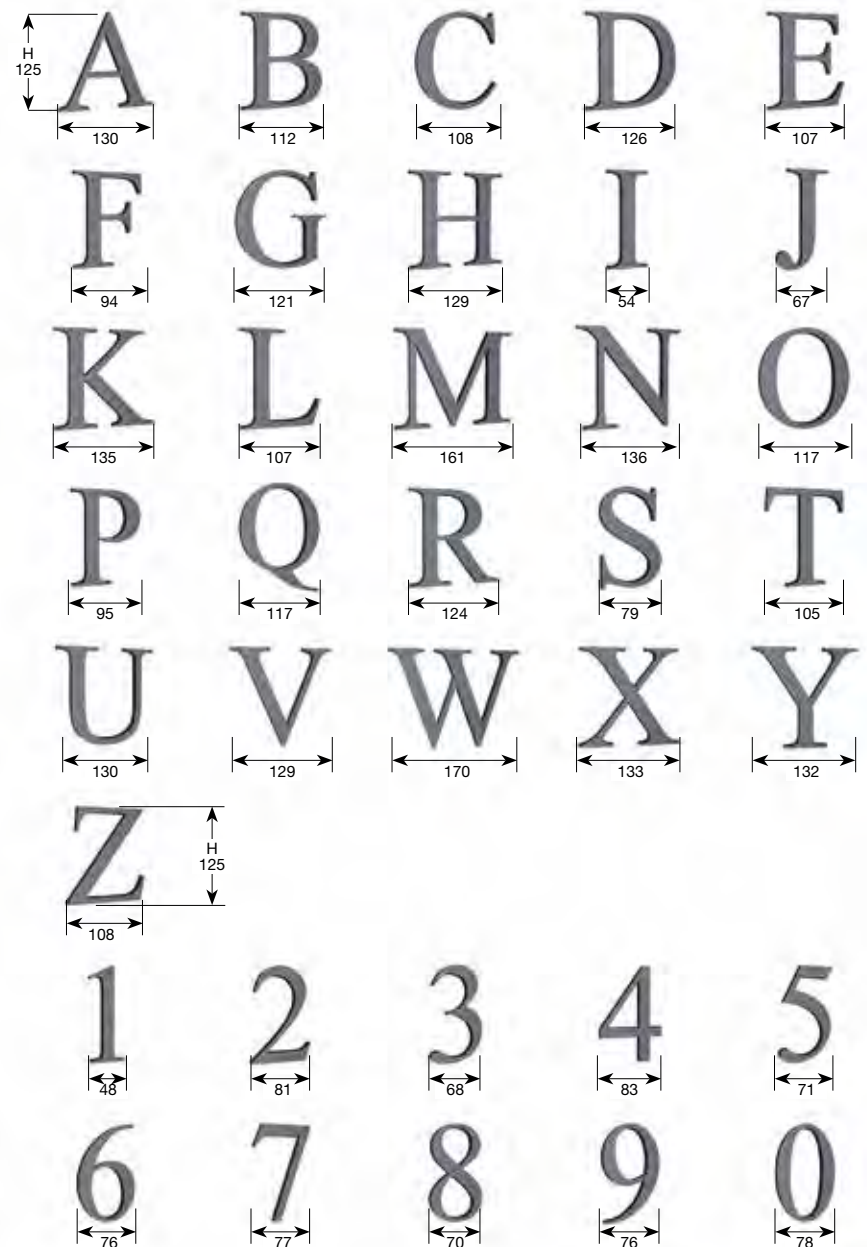

Le lettere e i numeri sono realizzati in spessore 3 o 4 mm e le dimensioni indicate sono approssimative. Su richiesta si possono fornire lettere e numeri in vari caratteri, misure e spessori.

STAFFE DECORATIVE

DECORATIVE BRACKETS

STAFFE DECORATIVE PER INFERRIATE SPORGENTI CON FISSAGGIO A TASSELLI

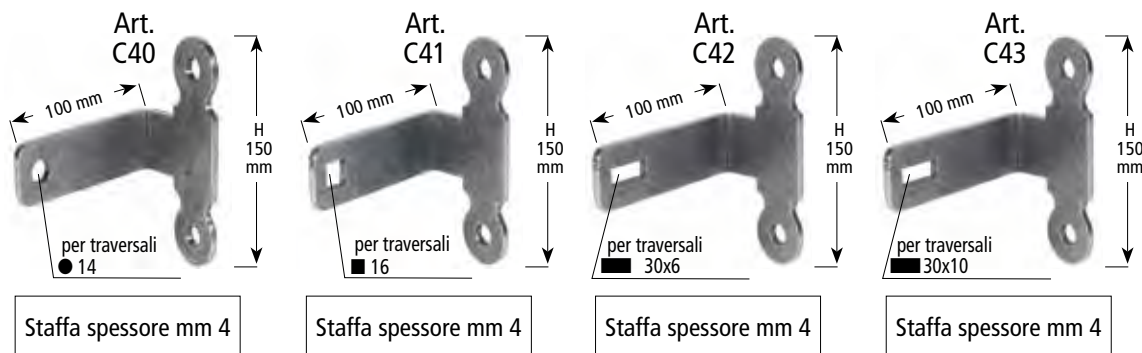

STAFFE DECORATIVE PER INFERRIATE INTERNE CON FISSAGGIO A TASSELLI

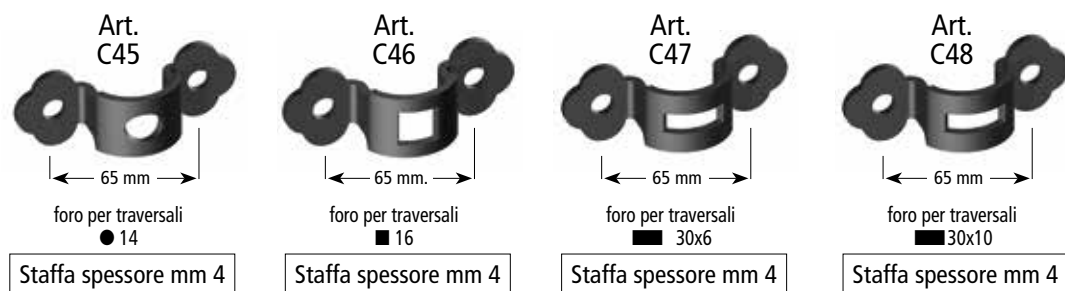

SCHEMA DI MESSA IN OPERA PER INFERRIATE INTERNE E SPORGENTI



Fissaggio a muro con tasselli
per inferriata sporgente



Fissaggio a muro con tasselli
per inferriata interna

STAFFE DECORATIVE PER MONTANTI

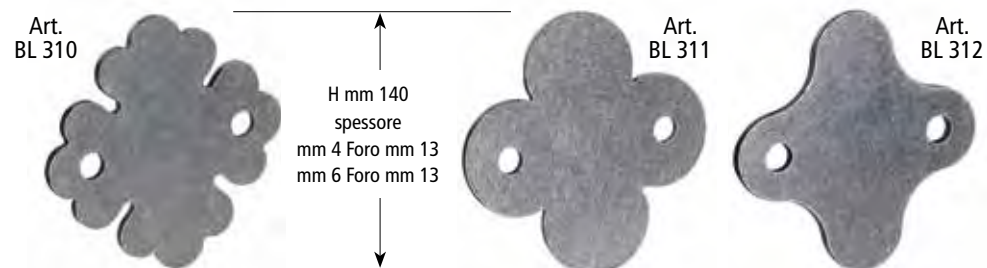

Esempio di fissaggio montante di recinzione



Esempio di fissaggio montante di scala



STAFFE DECORATIVE PER INFERRIATE INTERNE O SPORGENTI



Esempio di fissaggio traversali di inferriata sporgente

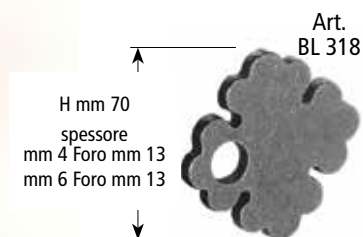

CANCELLETTI PORTA DI SICUREZZA (ORDINAZIONE E ACCESSORI)

SECURITY GATES (ORDER AND ACCESSORIES)

TUTTO MATERIALE GREZZO

CANCELLETTI-PORTA DI SICUREZZA CON TELAIO IN TUBO PER ARTT.:

BL2/BL7/BL12/BL17/BL22/BL27/BL32/BL37/BL42/1008/1016/1242/1248/BL341/BL346/BL351/BL356/BL361/A-02/A-07/A-14/A-19

Art. BL 321

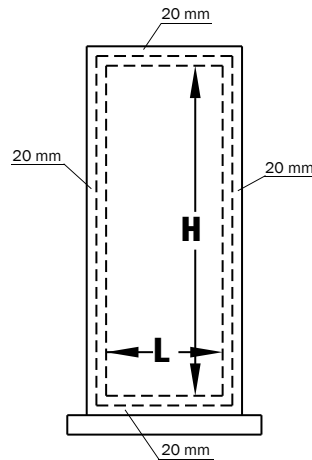
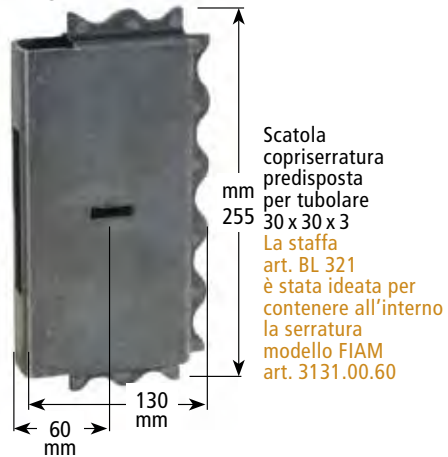

Art. BM 322
oppure
Art. BM 321

TUBO
30x30



Art. BL 320
SPESSORE MM 6



Incontro per cancelletti-porta con telaio in tubo mm 30 e in lamiera da mm 10.

Art. BM 322



Coppia di cardini per cancelletti-porta (DX E SX)
Piastra di fissaggio mm 100x100x5
Quadri mm70x30x30

Per facilitare l'ordinazione del cancelletto-porta con telaio in tubo, è sufficiente trasmettere le misure **L** e **H** interno telaio e richiedere il modello scelto. Vi sarà così fornito il cancelletto-porta in materiale grezzo, completo e **SU MISURA.** **(Telaio e accessori SU RICHIESTA)**

Art. BM 321



Coppia di cardini per cancelletti-porta (INVERTIBILI)
Perno a muro L mm 200 diam. 22
Quadri mm70x30x30

STAFFE PER INFERRIATE E CANCELLETTI PORTA DI SICUREZZA (ORDINAZIONE E ACCESSORI)

BRACKETS FOR GRATES AND SECURITY GATES (ORDER AND ACCESSORIES)

STAFFE DECORATIVE PER INFERRIATE INTERNE E SPORGENTI IN LAMIERA

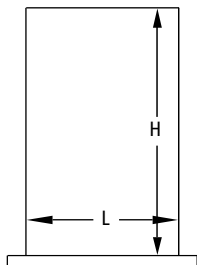

Per facilitare l'ordinazione delle inferriate interne e/o sporgenti in LAMIERA è sufficiente trasmettere le misure **L** e **H** del vano finestra, il modello scelto dal catalogo CUT DESIGN e lo spessore della lamiera mm 6/8. Vi sarà così fornita l'inferriata interna e/o sporgente in LAMIERA in materiale **grezzo**, completa e **SU MISURA**.
(Accessori SU RICHIESTA)

MODELLO DEPOSITATO

ART. BL 308
spessore mm 10
L = mm 172
Grezzo

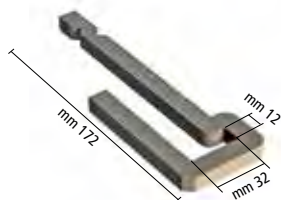

Supporto di fissaggio per inferriata sporgente in lamiera.

MODELLO DEPOSITATO

ART. BL 309
spessore mm 10
L = mm 162
Grezzo

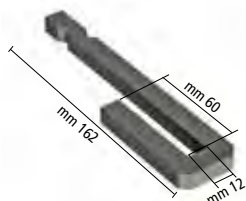

Supporto di fissaggio per inferriata interna in lamiera.

Art. BM 322



Coppia di cardini per cancelletti-porta (DX E SX)
Piastra di fissaggio mm 100x100x5
Quadri mm 70x30x30

Art. BM 321



Coppia di cardini per cancelletti-porta (INVERTIBILI)
Perno a muro L mm 200 diam. 22
Quadri mm 70x30x30

Art. BL 320 SPESSORE MM 6



Incontro per cancelletti-porta con telaio in tubo mm 30 e in lamiera da mm 10.

Art. 226



Scatola copriserratura per cancelletti-porta in lamiera da mm 10. Predisposta per serratura Fiam a doppia mappa da infilare Art. 3131 - entrata 60 mm

CANCELLETTI-PORTA DI SICUREZZA IN LAMIERA PER ARTT.: AM191/AM1048/AM1118/AM1128/AM1178/AM1218/AM1248/AM1288/AM1298/AM1348/AM1358/AM1458/AM1478/AM1488/AM1498/AM1508/210/215/220/225/M1500/M1505/M1510/M1515/M1520/M1525/M1530/M1535/M1540/M1545/M1550/M1555/M1560/M1565/M1570/M1575/M1580/M1585/M1590/M1595/M1600/M1605/M1615/M1620/M1625/M1630/M1635/M1640/M1645/M1650

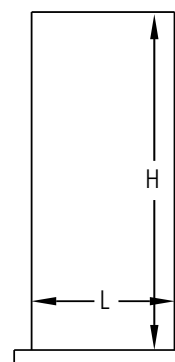

Per facilitare l'ordinazione del cancelletto-porta in lamiera, è sufficiente trasmettere le misure **L** e **H** del vano porta e richiedere il modello scelto. Vi sarà così fornito il cancelletto-porta in materiale liscio e grezzo, completo e **SU MISURA**.
(Accessori SU RICHIESTA)

Art. BM 322
oppure
Art. BM 321



LAMIERA
mm 10

Art. BL 320

Art. BM 322
oppure
Art. BM 321

CANCELLI CARRAI E PEDONALI (ORDINAZIONE E ACCESSORI)

GATES (ORDER AND ACCESSORIES)

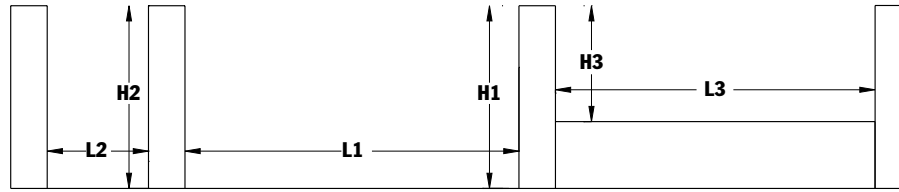

Per facilitare l'ordinazione dei cancelli e delle recinzioni presenti nei catalogo IRON UNO è sufficiente trasmettere le misure L e H dei pilastri e dei muretti e il modello scelto. Vi sarà così fornito il preventivo e il materiale grezzo, completo e SU MISURA. (Telaio e accessori SU RICHIESTA)



Art. C857
CARDINE A
FASCETTA
REGOLABILE
C/PIASTRA
ZINCATO



Art. C348
PERNO SFERICO
INFERIORE
GREZZO



Art. 345
composto da cardine
e perno da saldare
su lamiera

Zincato

Grezzo

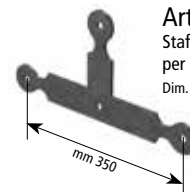

Art. 344
Staffa portaruota
per cancelli scorrevoli
Dim. mm 400x197

spessore mm 4 Fori mm 13
spessore mm 6 Fori mm 13
Grezzo

Art. C861T
TRONCHETTO DI
GIUNZIONE TONDO
PER CARDINE A
FASCETTA
GREZZO



Art. C349
PIASTRA PER
PERNO SFERICO
INFERIORE
GREZZA



Art. C380F
BATTENTE
D'ARRESTO A
FISSARE ZINCATO



Art. 346
composto da perno
da saldare su lamiera
e perno base inferiore

Zincato

Grezzo

Art. C348
Art. C349



Art. BL 323

MODELLO DEPOSITATO

ART.BL350
spessor e mm 4

Incontro per elettroserratura
per pedonali in tubo 40x40
Fori mm 13
Grezzo



SPESSORE MM 6

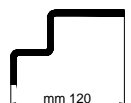

CANCELLI PEDONALI E RECINZIONI (ORDINAZIONE E ACCESSORI)

GATES AND FENCES (ORDER AND ACCESSORIES)



Art. BL 350

MODELLO DEPOSITATO

ART. BL 350
spessor e mm 4

Incontro per elettroserratura per pedonali in tubo 40x40
Fori mm 13
Grezzo



Art. BL 323

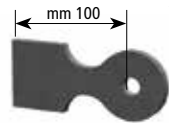

Art. BL 280
Staffa di fissaggio su colonna e pannello in lamiera
Dim. mm 120x40

spessore mm 4 Foro mm 12
spessore mm 6 Foro mm 13
Grezzo

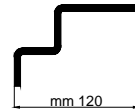

MODELLO DEPOSITATO

ART. BL 351
spessor e mm 4

Incontro per elettroserratura per pedonali in lamiera sp. mm 10
Fori mm 13
Grezzo



Art. 348

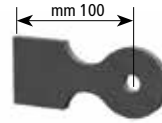

Art. BL 280

Staffa di fissaggio su colonna e pannello in lamiera

Dim. mm 120x40
spessore mm 4 Foro mm 12
spessore mm 6 Foro mm 13
Grezzo



Art. BL 370

Bulloni per staffe di fissaggio pannelli plasmati



Art. 341

Staffa di fissaggio colonna in metallo su muretto recinzione

Dim. mm 120x70
spessore mm 4 Fori mm
spessore mm 6 Fori mm
Grezzo

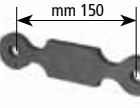

Art. 342

Staffa di collegamento tra pannello e pannello

spessore mm 4 Fori mm
spessore mm 6 Fori mm
Grezzo

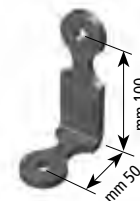

Art. 343

Staffa di collegamento tra pannello e muretto

spessore mm 4 Fori mm
spessore mm 6 Fori mm
Grezzo

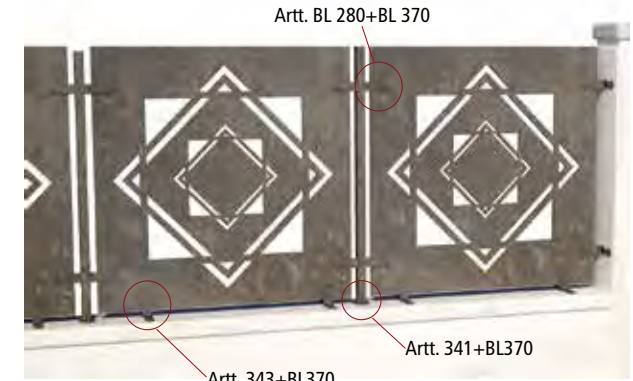

Art. BL 280+BL 370

Art. 343+BL370

Art. 341+BL370

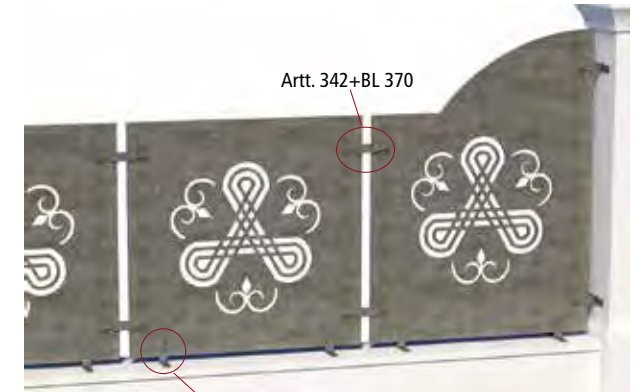

Art. 342+BL 370

Art. 343+BL370

CANCELLI CARRAI, PEDONALI E CANCELLETTI-PORTA (ACCESSORI)

GATES AND SECURITY GATES (ACCESSORIES)

Cerniera 2 all perno sfilabile

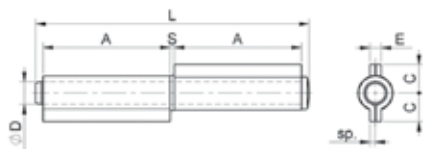

mm.	A	C	Sp	D	E	L	S
60	27	8,5	2	Ø6	4,5	61	2
80	36	10	2	Ø8	4,5	80	2
100	46	11,5	2	Ø9	4,5	100	2,2
120	56	12	2,3	Ø10	5	121	2,2
140	66	13	2,5	Ø11	5,5	142	2,2
140P	66	15	2,7	Ø12	6	142	2,2
170P	81	15	2,7	Ø12	6	171	2,2
200P	96	17	3	Ø14	6,5	202	2,3



Art. C100

Cerniera per cancelli 2 all corte perno zincato e rondella ottone

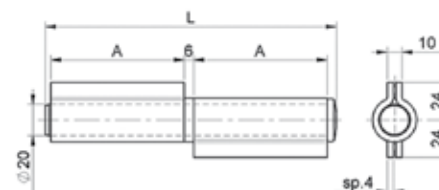

mm.	A	L
90	40	94
180	85	185



Art. C175

Cerniera per cancelli 3 all corte con perno zincato e rondelle ottone

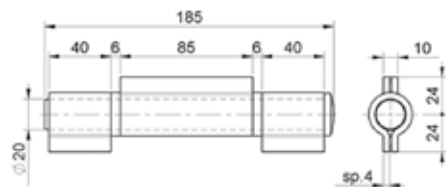

mm.
180



Art. C185

Catenaccio verticale 10x10 zincato c/punta tonda

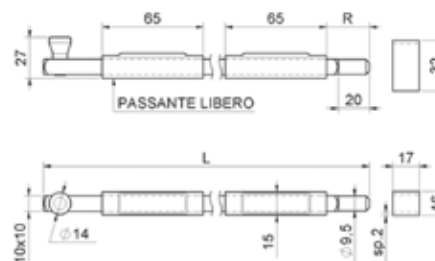

mm.	L	R	Passanti
130	130	2-40	n.1
300	300	2-40	n.2
500	500	2-40	n.2



Art. C206

Catenaccio verticale zincato

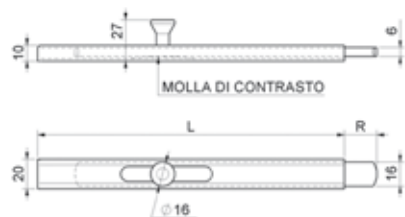

mm.	L	R
150	150	0-49
200	200	0-49
250	250	0-49
300	300	0-49
400	400	0-49
500	500	0-49
700	700	0-49



Art. C215

Catenaccio UNA azione c/leva OTTONE Zincato

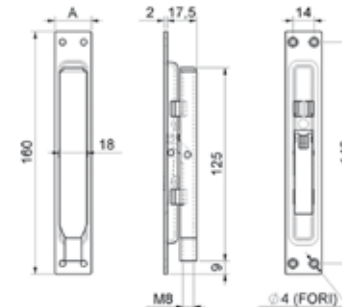

mm.	A	Corsa
20	20	17
24	24	17



Art. C223

CANCELLI CARRAI, PEDONALI E CANCELLETTI-PORTA (ACCESSORI) GATES AND SECURITY GATES (ACCESSORIES)

Fisce

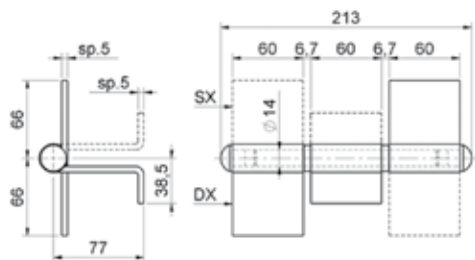

Art. C238

PALETTO A LEVA ZINCATO con passanti di guida

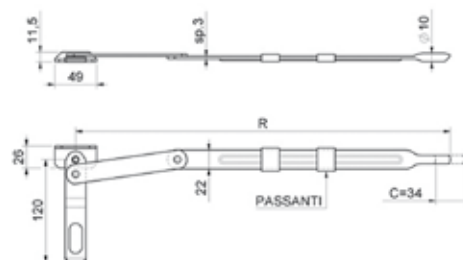

Art. C305

mm.	R	Passanti
600	571-605	3 PZ.

mm.
Dx/Sx

Copripiastro quadro

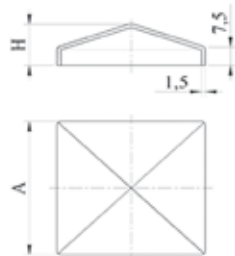

Art. C340

Misura	A	H
mm.30	34	13
mm.40	44	15
mm.50	54	17
mm.60	64	20
mm.80	64	22
mm.100	104	26
mm.120	124	29
mm.150	154	35

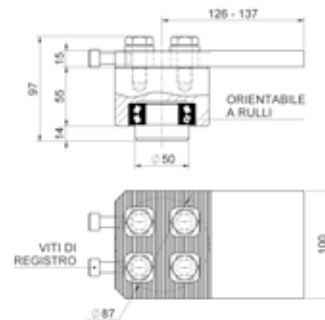

Art. C345MAXI

mm.	Viti TE	Viti registro
MAXI	M14	M10

Cardine regolabile zincato c/cuscinetto

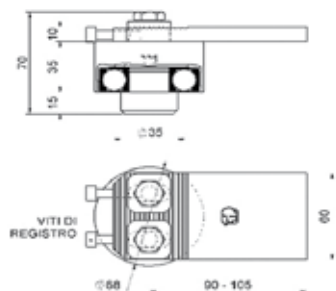

Art. C345RG

CARDINE CON CUSCINETTO ZINCATO - REGOLABILE

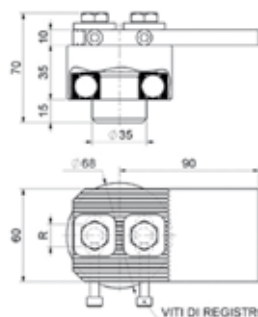

Art. C345RGL

mm.	Viti TE	Viti registro
GRANDE	M10	M6

CANCELLI CARRAI, PEDONALI E CANCELLETTI-PORTA (ACCESSORI)

GATES AND SECURITY GATES (ACCESSORIES)

Cardine con cuscinetto zincato-regolabile per attacco laterale, da fissare, con viti di registro

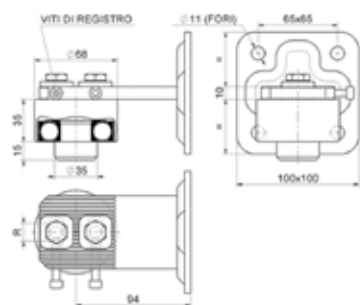

mm.	Viti TE	Viti registro	R
GRANDE	M10	M6	±7



Art. C345RGLPST

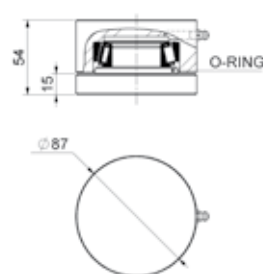

mm.
MAXI



Art. C346MAXI

Piastra girevole zincata c/cuscinetto reggispinta c/ingrassatore Grande diametro 70



mm.
GRANDE



Art. C346G

Piastra girevole zincata c/cuscinetto reggispinta c/ingrassatore Piccola diametro 45

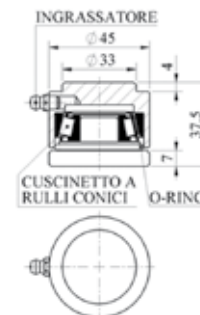

mm.
PICCOLA



Art. C346P

Perno sferico inferiore

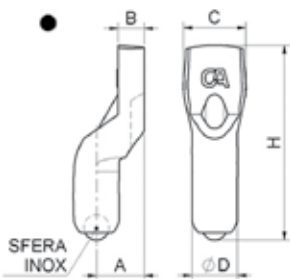

Ø	A	B	C	ØD	H	Finitura	
20	• (*)	21	11	27	Ø20	85	Grezzo
24	• (*)	25	14	32	Ø24	96	Grezzo
27	•	28	15	40	Ø28	103	Grezzo



Art. C348

Piastra per perno sferico inferiore

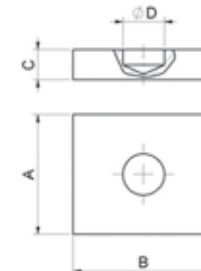

	Ø	A	B	C	ØD
Grezzo	20	60	70	15	Ø20,5
Grezzo	24	60	70	20	Ø24,5
Grezzo	27	79	80	20	Ø28,5

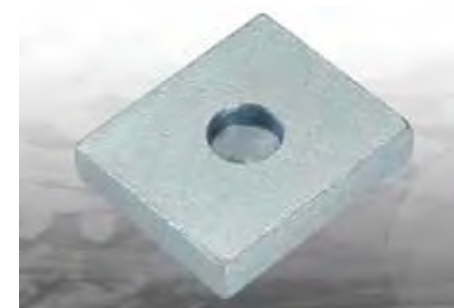

Art. C349

CANCELLI CARRAI, PEDONALI E CANCELLETTI-PORTA (ACCESSORI)

GATES AND SECURITY GATES (ACCESSORIES)

Serratura a gancio zincata c/controlpiastra c/cilindro - tub. 60

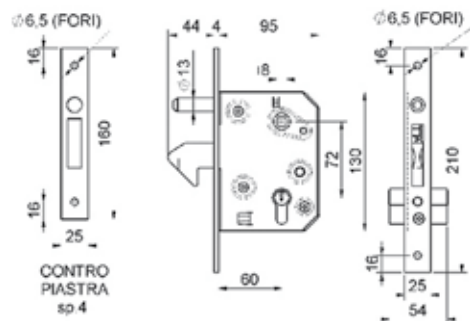

mm.
60



Art. C350

Battente portaincontro regolabile zincato per elettroserrature

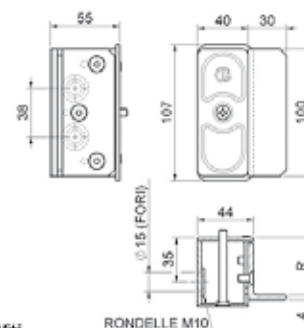

mm. R Viti
UNICA 45-55 M6



Art. C352

Battente portaincontro regolabile zincato per elettroserrature c/ali a fissare o saldare

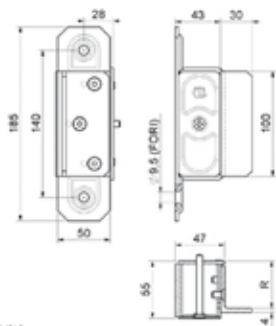

mm. R VITI
UNICA 45-55 M6



Art. C352F

Scatola copriserratura zincata

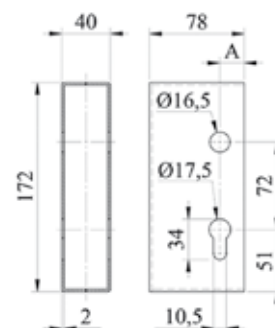

Ø A
40 20
50 10



Art. C354

Maniglia c/vite in testa verniciata nera

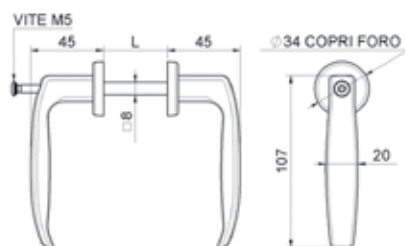

mm. L
25-35 25-35
40-50 40-50
50-60 50-60



Art. C355

Cardine c/cavallotto c/boccola Zincato

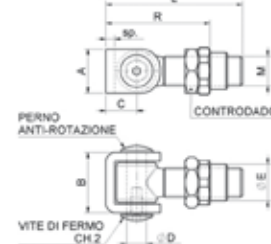

mm.	A	B	C	ØD	ØE	L	sp.	M	R	CH.2
M16	27	36	21	Ø12	Ø21	79	5	M16	52-66	Es.4
M18	30	41	21	Ø14	Ø25	81	6	M18	57-68	Es.5
M20	30	41	21	Ø14	Ø25	92	6	M20	58-78	Es.5
M22	35	48	25	Ø17	Ø27	96	6	M22	64-82	Es.6
M24	35	47	25	Ø17	Ø30	96	6	M24	67-80	Es.6



Art. C376

CANCELLI CARRAI, PEDONALI E CANCELLETTI-PORTA (ACCESSORI)

GATES AND SECURITY GATES (ACCESSORIES)

Cardine c/piastra 100x100 c/cavallotto Zincato

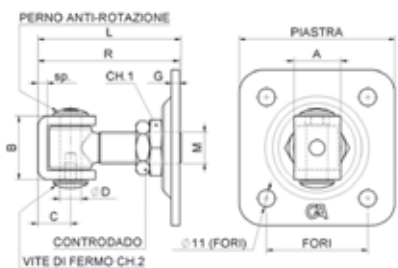

mm.	A	B	C	ØD	G	L	Sp.	M	R	CH.1	CH.2	Piastra	Fori
M16	27	36	21	Ø12	5	79	5	M16	64-78	Es.36	Es.4	80x80	56x56
M18	30	41	21	Ø14	5	91	5	M18	68-80	Es.36	Es.5	80x90	56x56
M20	30	41	21	Ø14	5	92	5	M20	70-91	Es.36	Es.5	100x100	65x65
M22	35	48	25	Ø17	5	96	5	M22	76-95	Es.36	Es.6	100x100	65x65
M24	35	48	25	Ø17	5	96	5	M24	77-95	Es.36	Es.6	100x100	65x65
M27	35	48	25	Ø17	5	107	5	M27	82-106	Es.46	Es.6	120x120	90x90



Art. C378

Battente d'arresto Zincato

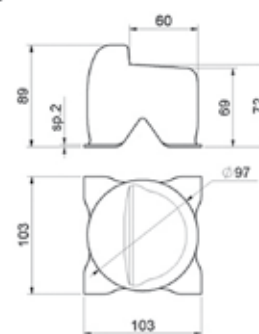

mm.
UNICA



Art. C380

Battente d'arresto a fissare Zincato

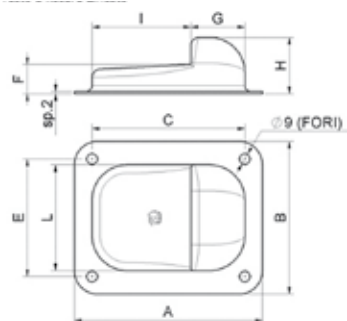

mm.	A	B	C	E	F	G	H	I	L
GRANDE	160	130	130	100	25	46	48	84	90



Art. C380F

Arresto fine corsa zincato

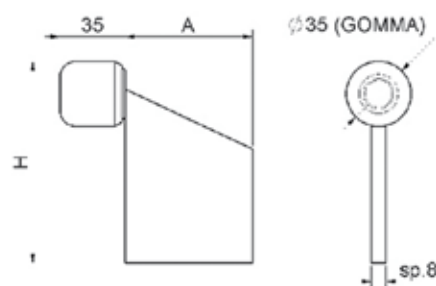

mm.	A	H
PICCOLO	50	90
GRANDE	70	110



Art. C381

Arresto fine corsa zincato c/piastra a fissare

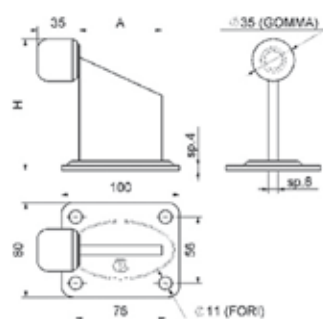

mm.	A	H
GRANDE	70	111

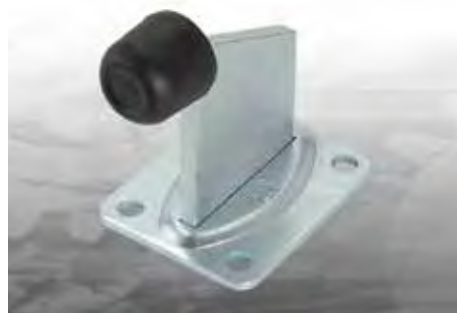

Art. C382

Arresto fine corsa con piastra copri-binario a fissare Zincato

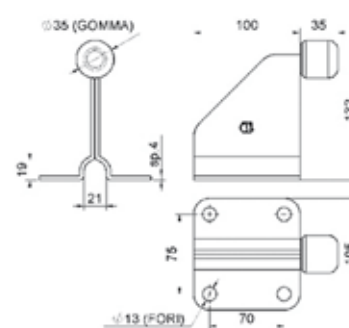

mm.
GRANDE

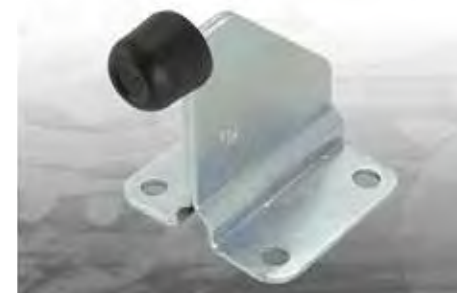

Art. C383

CANCELLI CARRAI, PEDONALI E CANCELLETTI-PORTA (ACCESSORI) GATES AND SECURITY GATES (ACCESSORIES)

Cariglione quadro 14 zincato c/cilindro

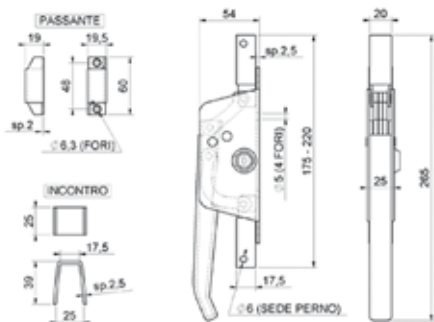

Art. C391

Ruota gola tonda 1 cuscinetto

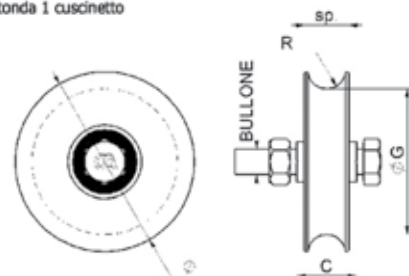

Art. C400

mm.	C	ØG	Sp	R	Cuscinetto	Bullone	x Articolo	Portata
Ø100/20	33	Ø79	24	10,3	1	M14x70	900-902 Ø20	Kg.230
Ø120	33	Ø99	24	10,3	1	M14x70	900-902 Ø20	Kg.250
Ø140	43	Ø117	25	10,3	1	M16x70	900-902 Ø20	Kg.280
Ø160	43	Ø137	25	10,3	1	M16x70	900-902 Ø20	Kg.300

Ruota gola V 1 cuscinetto

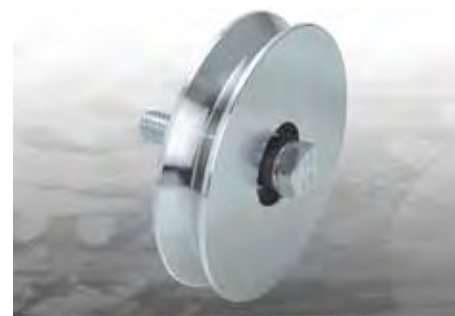
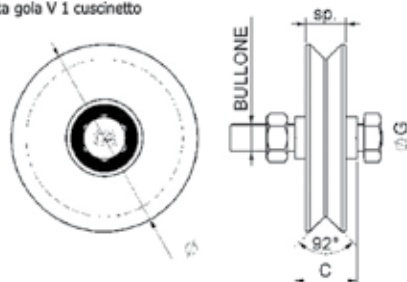

Art. C402

Ruota gola tonda 2 cuscinetti

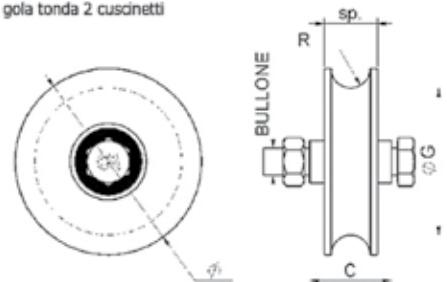

Art. C405

Ø	C	ØG	Sp	R	Bullone	Cuscinetti	Binario	Portata
100	43	Ø77	28	10,3	M14x70	2	Art.900-902 Ø20	410 Kg.
120	43	Ø97	28	10,3	M14x70	2	Art.900-902 Ø20	430 Kg.
140	43	Ø117	32	10,3	M16x70	2	Art.900-902 Ø20	550 Kg.
160	43	Ø137	32	10,3	M16x70	2	Art.900-902 Ø20	570 Kg.

Misura	C	ØG	Sp	Cuscinetto	Bullone	Binario	Portata
Ø100	33	Ø82	21	1	M14x70	906	Kg.230
Ø120	33	Ø100	24	1	M14x70	906	Kg.250
Ø140	43	Ø118	25	1	M16x70	906	Kg.280
Ø160	43	Ø138	25	1	M16x70	906	Kg.300

Ruota gola V 2 cuscinetti

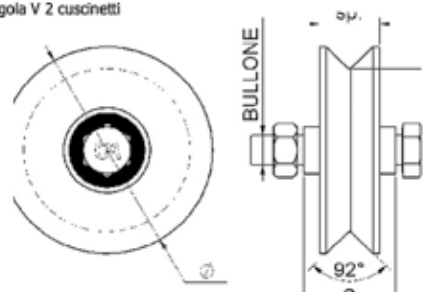

Art. C407

Ruota gola V 1 cuscinetto supporto laterale

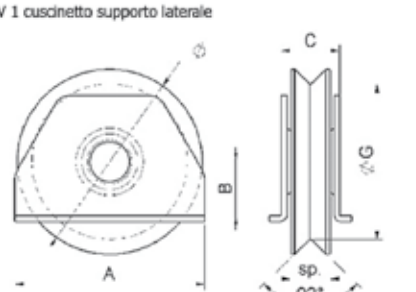

Art. C417

Ø	A	B	C	ØG	Sp.	Cuscinetti	Binario	Portata
100	100	28,5	31	Ø82	21	1	Art.906	230 Kg.
120	120	38	33	Ø100	24	1	Art.906	250 Kg.
140	140	48,5	34	Ø118	25	1	Art.906	280 Kg.

Ø	C	ØG	Sp.	Bullone	Cuscinetti	Binario	Portata
100	43	Ø77	28	M14x70	2	Art.906	410 Kg.
120	43	Ø97	28	M14x70	2	Art.906	430 Kg.
140	43	Ø117	32	M16x70	2	Art.906	550 Kg.
160	43	Ø137	32	M16x70	2	Art.906	570 Kg.

CANCELLI CARRAI, PEDONALI E CANCELLETTI-PORTA (ACCESSORI)

GATES AND SECURITY GATES (ACCESSORIES)

Ruota gola tonda 1 cuscinetto supporto interno

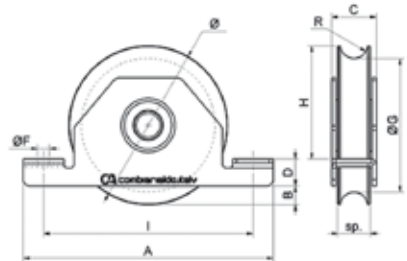

Art. C425

Ø	A	B	C	D	ØF	ØG	H	I	Sp	R	Cuscinetti	Binario	Portata
100/20	155	14	33	18	Ø9	Ø79	66	130	24	10,3	1	art.900-902 Ø20	230 Kg.
120	185	14	32	20	Ø9	Ø99	84	155	24	10,3	1	art.900-902 Ø20	250 Kg.
140	205	15	32	22	Ø11	Ø117	100	175	24	10,3	1	art.900-902 Ø20	280 Kg.
160	225	20	37	24	Ø11	Ø137	113	195	25	10,3	1	art.900-902 Ø20	300 Kg.

Ruota gola tonda 1 cuscinetto supporto interno

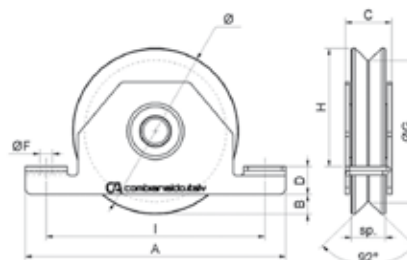

Art. C427

Ø	A	B	C	D	ØF	ØG	H	I	Sp	Cuscinetti	Portata	Binario
100	155	14	33	18	Ø9	Ø82	66	130	21	1	230 Kg.	art.906
120	185	14	32	20	Ø9	Ø100	84	155	24	1	250 Kg.	art.906
140	205	15	32	22	Ø11	Ø118	100	175	24	1	280 Kg.	art.906
160	225	20	37	24	Ø11	Ø138	113	195	25	1	300 Kg.	art.906

Ruota gola tonda 2 cuscinetti supporto interno

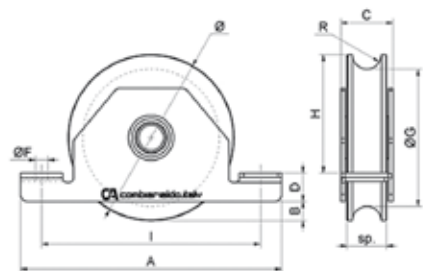

Art. C430

Ø	A	B	C	D	ØF	ØG	H	I	Sp	R	Cuscinetti	Portata	Binario
100	155	14	33	18	Ø9	Ø77	66	130	28	10,3	2	410 Kg.	art.900-902 Ø20
120	185	14	37	20	Ø9	Ø97	84	155	28	10,3	2	430 Kg.	art.900-902 Ø20
140	205	15	42	22	Ø11	Ø117	100	175	32	10,3	2	550 Kg.	art.900-902 Ø20
160	225	20	42	24	Ø11	Ø137	113	195	32	10,3	2	630 Kg.	art.900-902 Ø20

Ruota gola tonda 1 cuscinetto c/ingrassatore

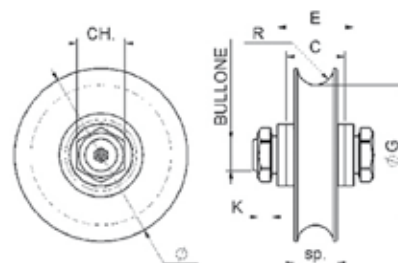

Art. C435

Ø	C	E	ØG	Sp	R	CH	K	Cuscinetti	Bullone	Binario	Portata
100	33	43	Ø79	24	10,3	Es.27	8	1	M18X60	Art.900-902 Ø20	380 Kg.
120	33	43	Ø99	24	10,3	Es.27	8	1	M18X60	Art.900-902 Ø20	400 Kg.
140	43	53	Ø117	25	10,3	Es.30	9	1	M20X70	Art.900-902 Ø20	670 Kg.
160	43	53	Ø137	25	10,3	Es.30	9	1	M20X70	Art.900-902 Ø20	700 Kg.

Ruota gola V 1 cuscinetto c/ingrassatore

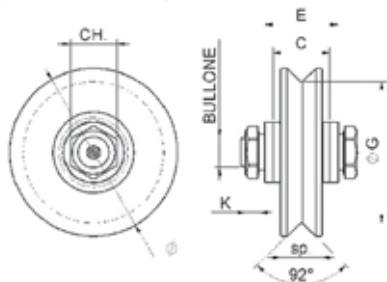

Art. C437

Ø	C	E	ØG	Sp	CH	K	Bullone	Cuscinetti	Binario	Portata
100	33	43	Ø82	24	Es.27	8	M18X60	1	Art.906	380 Kg.
120	33	43	Ø100	24	Es.27	8	M18X60	1	Art.906	400 Kg.
140	43	53	Ø118	25	Es.30	9	M20X70	1	Art.906	670 Kg.
160	43	53	Ø138	25	Es.30	9	M20X70	1	Art.906	700 Kg.

Ruota gola tonda 2 cuscinetti c/ingrassatore

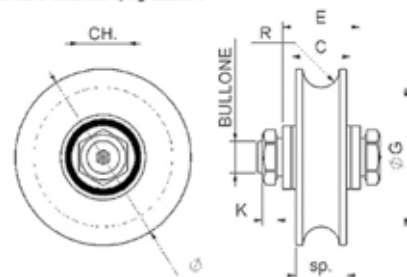

Art. C440

Ø	C	E	ØG	Sp	R	CH	K	Bullone	Cuscinetti	Binario	Portata
100	33	43	Ø77	28	10,3	Es.27	8	M18X60	2	Art.900-902 Ø20	560 Kg.
120	33	43	Ø97	28	10,3	Es.27	8	M18X60	2	Art.900-902 Ø20	580 Kg.
140	43	53	Ø117	32	10,3	Es.30	9	M20X70	2	Art.900-902 Ø20	920 Kg.
160	43	53	Ø137	32	10,3	Es.30	9	M20X70	2	Art.900-902 Ø20	940 Kg.

CANCELLI CARRAI, PEDONALI E CANCELLETTI-PORTA (ACCESSORI) GATES AND SECURITY GATES (ACCESSORIES)

Ruota gola V 2 cuscinetti c/Ingrassatore

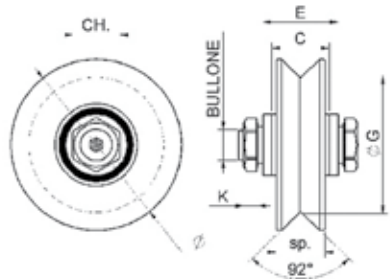

Art. C442

Ø	C	E	ØG	Sp	CH	K	Bullone	Cuscinetti	Cuscinetti	Binario	Portata
100	33	43	Ø77	28	Es.27	8	M18x60	2	Art.906	560 Kg.	
120	33	43	Ø97	28	Es.27	8	M18x60	2	Art.906	580 Kg.	
140	43	53	Ø117	32	Es.30	9	M20x70	2	Art.906	920 Kg.	
160	43	53	Ø137	32	Es.30	9	M20x70	2	Art.906	940 Kg.	

Oliva nylon

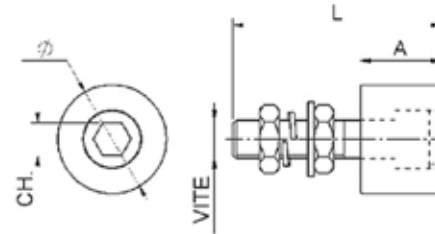

Art. C447

Ø	A	L	CH	Vite
25	30	70	Es.10	M12x55
30	30	77	Es.12	M14x60
40	30	77	Es.12	M14x60

Oliva nylon bombata

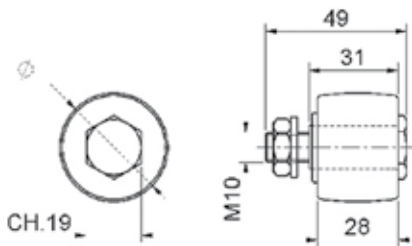

Art. C449

Oliva nylon

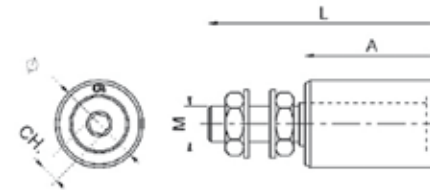

Art. C450

Ø	A	CH.	L	M
25x30	33	Es.6	65	M14
30x40	40	Es.6	76	M14
40x45	45	Es.8	83	M16
40x60	60	Es.8	102	M16

Ø
40x30

Piastra guida 4 olive bombate nylon

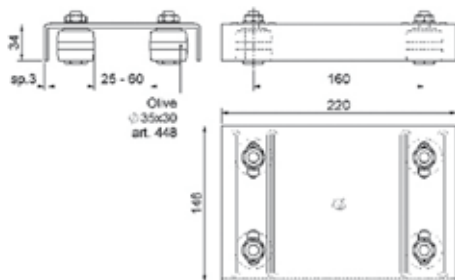

Art. C461

mm.
UNICA

Piastra guida regolabile 4 olive nylon

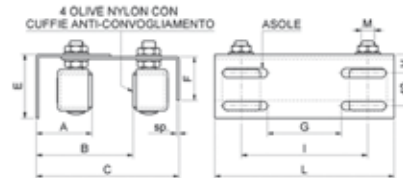

Art. C462

mm.	A	B	C	E	F	G	H	I	L	M	Asole	Sp.	Olive
Piccola	43-66	93-156	149-197	76	54	91	21	155	220	M14	11x54	3	Ø30x40
Media	47-90	89-151	149-197	76	54	91	21	155	220	M16	11x54	3	Ø40x45
Grande	49-91	110-195	200-243	81	74	157	26	285	350	M16	11x63	4	Ø40x60

CANCELLI CARRAI, PEDONALI E CANCELLETTI-PORTA (ACCESSORI)

GATES AND SECURITY GATES (ACCESSORIES)

Incontro superiore universale regolabile zincato

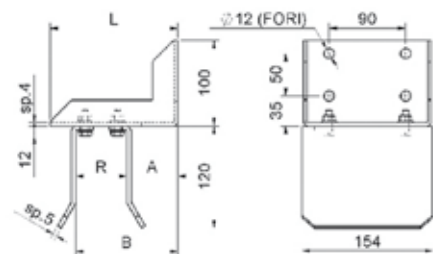

Art. C465

mm.	A	B	E	F	G	L	R	Bulloni
PICCOLO	36-104	76-144	105	80	40	150	40-108	M8
MEDIO	36-104	76-144	120	154	90	150	40-108	M8
GRANDE	56-184	96-224	120	154	90	230	40-168	M8

Incontro superiore zincato regolabile

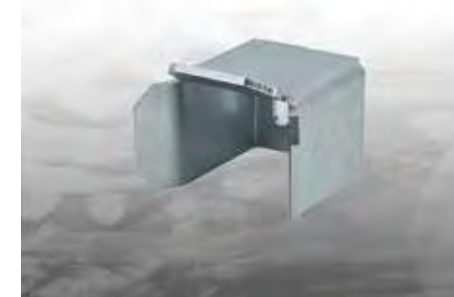
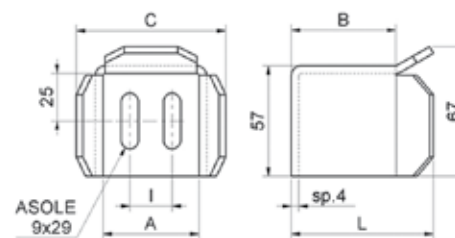

Art. C468

mm.	A	B	C	I	L
Tub.40	50	55	78	22	74
Tub.50	60	65	88	30	84
Tub.60	70	75	98	30	94

Antistrappo perno filettato

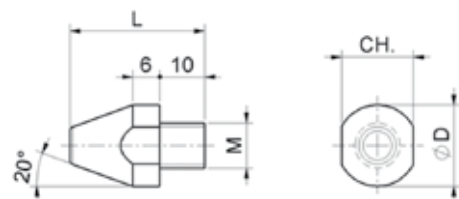

Art. C730

mm.	ØD	L	CH.
M8	Ø16	28	14
M10	Ø16	30	16

Antistrappo per vite testa svasata

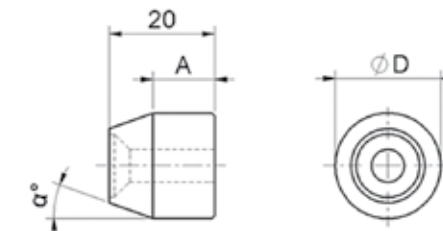

Art. C731

Ø	ØD	A	α°
16	Ø16	13	10°
20	Ø20	12	20°

Carrello scorrevole zincato 2 ruote/cuscinetti

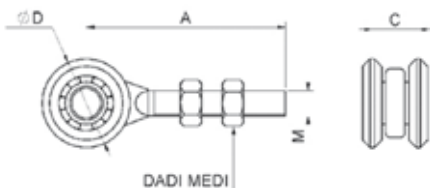

Art. C750

mm.	A	C	ØD	M	Portata
PICCOLO	48	21,5	Ø24	M8	Kg.30
MEDIO	95	22	Ø42	M12	Kg.100
GRANDE	125	30	Ø55	M20	Kg.200

Carrello scorrevole zincato 4 ruote/cuscinetti

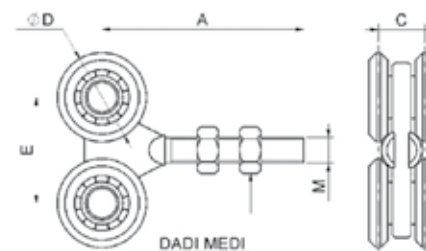

Art. C752

mm.	A	C	ØD	E	M	Portata
PICCOLO	48	21,5	Ø24	30	M8	Kg.50
MEDIO	95	22	Ø42	50	M12	Kg.300
GRANDE	125	30	Ø55	60	M20	Kg.375

CANCELLI CARRAI, PEDONALI E CANCELLETTI-PORTA (ACCESSORI)

GATES AND SECURITY GATES (ACCESSORIES)

Cremagliera zincata rettangolare 30x12 m.4

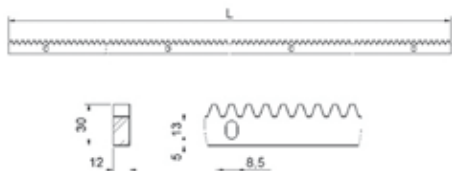

Art. C805

Attacco zincato per cremagliera a saldare

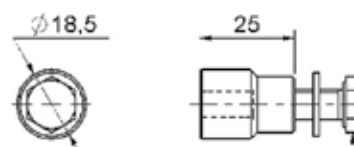

VITE TE M8x25
CON RONDELLA



Art. C810

m.	L	Modulo	Nr.denti	Nr.asole	Passo	Ang.press.
1	1005	M.4	80	3	12,566	20°
2	2010	M.4	160	4	12,566	20°

mm.
UNICA

Cremagliera nylon c/attacchi inferiori - mod. medio

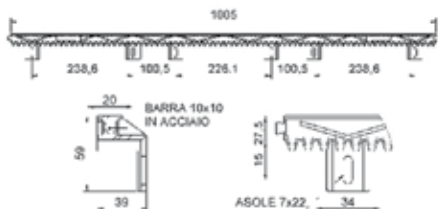

Art. C822NY

Cardine MATRIX c/piastra con ingrass. Zincato

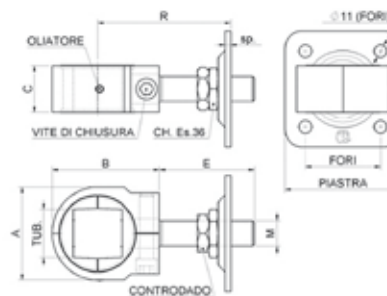

Art. C848

mm.	A	B	C	E	M	Sp	R	Vite	Piastra	Fori
TUB.40	80	92,5	40	82	M22	5	85-135	M12	100x100	65x65

m.	Modulo	Nr.denti	Passo	Ang.press.
1	M.4	80	12,566	20°

Cardine a fascetta c/boccola Zincato

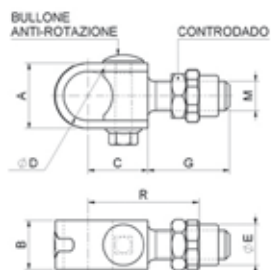

Art. C855

Cardine a fascetta regolabile c/piastra Zincato

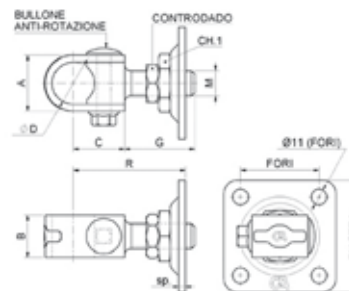

Art. C857

mm.	A	B	C	ØD	G	M	R	Sp	CH.1	Bullone	Piastra	Fori
M18	40	30	36,5	Ø30	50	M18	70-87	5	Es.36	M10	80x80	56x56
M22	47	35	42,5	Ø35	55	M22	77-98	6	Es.36	M12	100x100	65x65
M27	52	40	48,5	Ø40	60	M27	89-109	6	Es.46	M12	120x120	90x90

mm.	A	B	C	ØD	ØE	G	M	R	Bullone
M18	40	30	36,5	Ø30	Ø25	50	M18	59-74	M10
M22	47	35	42,5	Ø35	Ø27	55	M22	65-83	M12
M27	52	40	48,5	Ø40	Ø35	60	M27	75-93	M12

CANCELLI CARRAI, PEDONALI E CANCELLETTI-PORTA (ACCESSORI)

GATES AND SECURITY GATES (ACCESSORIES)

Anello di sicurezza zincato

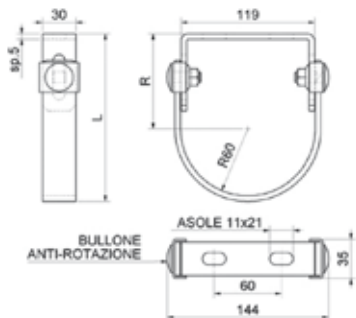

mm.	R	L
UNICA	70-100	135-165



Art. C858

Tronchetto di giunzione per cardine a fascetta

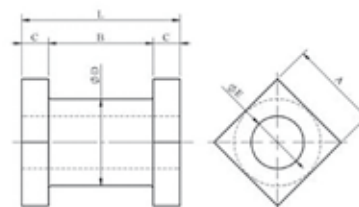

Ø	A	B	C	ØD	ØE	L	Tub.	Cardine
30	30x30	35	9	Ø29	Ø17,5	53	30	M18
35	35x35	40	9	Ø34	Ø17,5	58	35	M22
40	40x40	45	10	Ø39	Ø17,5	65	40	M27

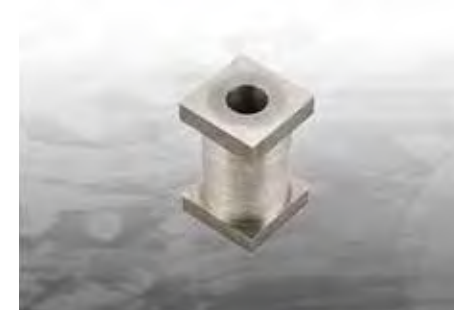

Art. C861P

Tronchetto di giunzione tondo per cardine a fascetta

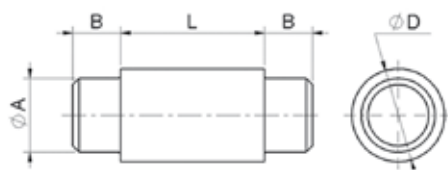

Ø	Tubolare	Cardine	ØA	B	ØD	L
30	Ø30	M18	Ø24	15	Ø29	45
35	Ø35	M22	Ø29	15	Ø34	50
40	Ø40	M27	Ø34	15	Ø39	55



Art. C861T

Cardine con alette c/boccola Zincato



Misura	A	B	C	ØD	ØE	L	Sp	M	R	CH.2
M18	• 30	42	21	Ø14	Ø25	81	6	M18	57-69	Es.5
M22	• 35	43	25	Ø17	Ø27	90	8	M22	61-75	Es.6
M27	• 40	53	25	Ø20	Ø35	102	8	M27	67-88	--



Art. C876

Cardine con alette c/piastra Zincato

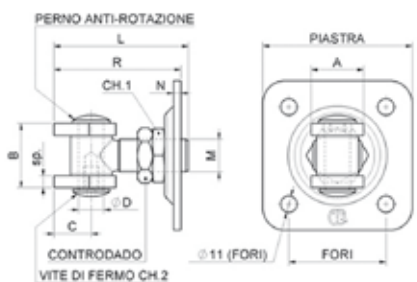

mm.	A	B	C	ØD	L	Sp	M	N	R	Fori	Piastra	CH.1	CH.2
M18	• 30	42	21	Ø14	81	6	M18	5	68-81	56x56	80x80	Es.36	Es.5
M22	• 35	43	25	Ø17	90	8	M22	5	73-90	65x65	100x100	Es.36	Es.6
M27	• 40	53	25	Ø20	102	8	M27	6	86-103	90x90	120x120	Es.46	--



Art. C878

Giunzione zincata per guida a cementare e fissare

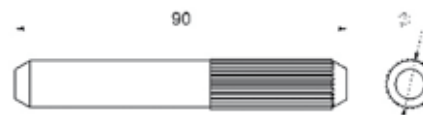

Ø	Binario
9	Ø16
13	Ø20



Art. C901

CANCELLI CARRAI, PEDONALI E CANCELLETTI-PORTA (ACCESSORI)

GATES AND SECURITY GATES (ACCESSORIES)

Guida tonda zincata a fissare

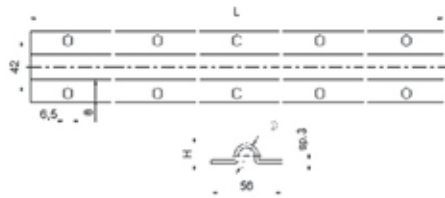

Ø	Ø	L	H	Asole
16 - 3m.	16	3000	13	nr.9+9
16 - 6m.	16	6000	13	nr.17+17
20 - 3m.	20	3000	16	nr.9+9
20 - 6m.	20	6000	16	nr.17+17



Art. C902

Binario Tondo Aperto Ø20 a cementare Zincato

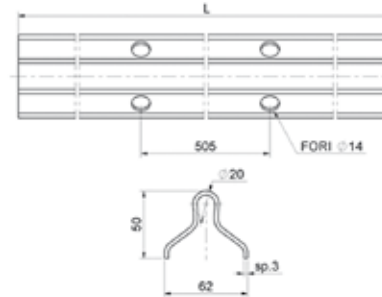

codice	Ø	L
904.20x3	20 - 3 m	3000
904.20x6	20 - 6 m	6000

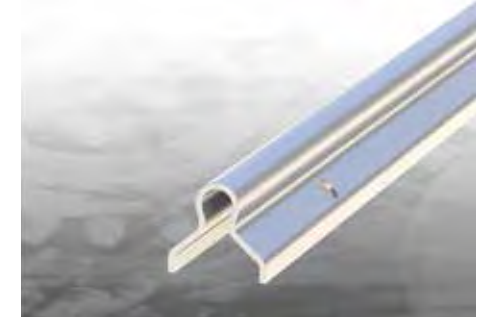

Art. C904

art. 906
Guida a

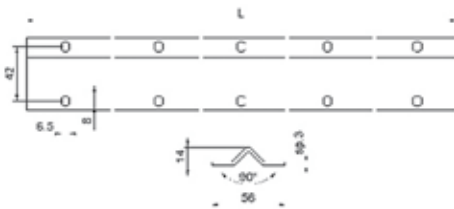

m.	L	Asole
3	3000	nr. 9+9
6	6000	nr. 17+17



Art. C906

Pozzetto in ottone antipolvere c/molla inox

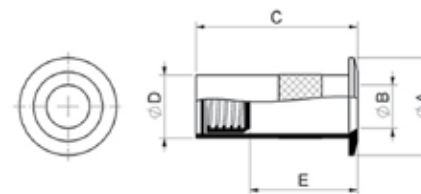

Ø	ØA	ØB	C	ØD	E
Ø18	Ø30	Ø18	31	Ø22	20



Art. C2010

BARRE FORATE SU MISURA

HOLED BARS IN SPECIAL SIZE



Art. 1050

BARRA FORATA
SU MISURA

SPESSORI IN
TONDO E QUADRO
DA MM

- 12
- 14
- 16
- 18
- 20
- 22

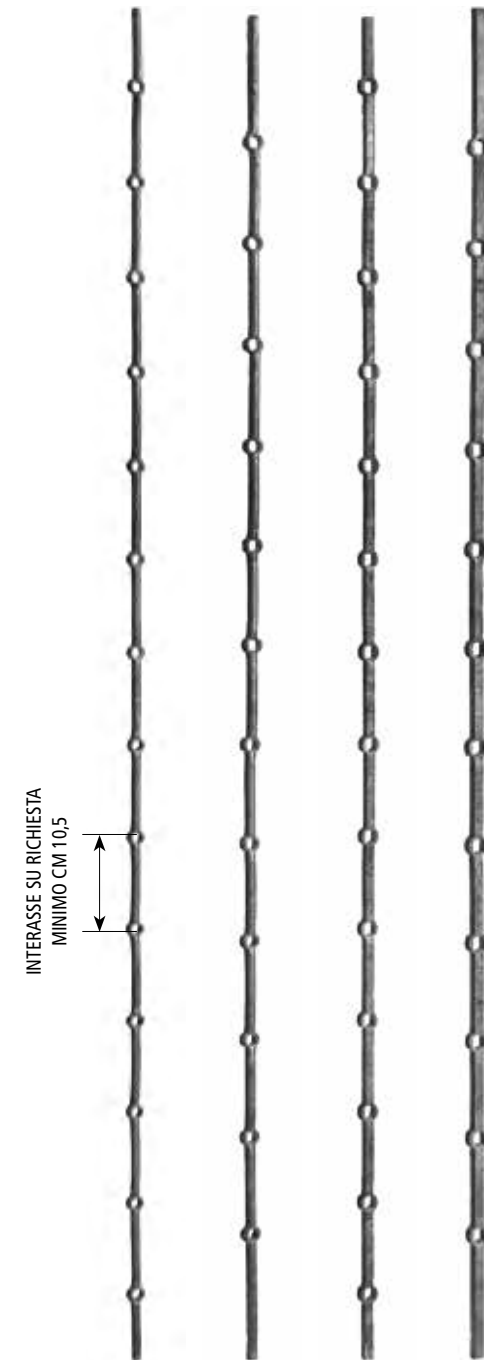

Art. 1051

BARRA FORATA
SU MISURA
CON CURVE



PIATTI FORATI IRON PLATE WITH HOLES

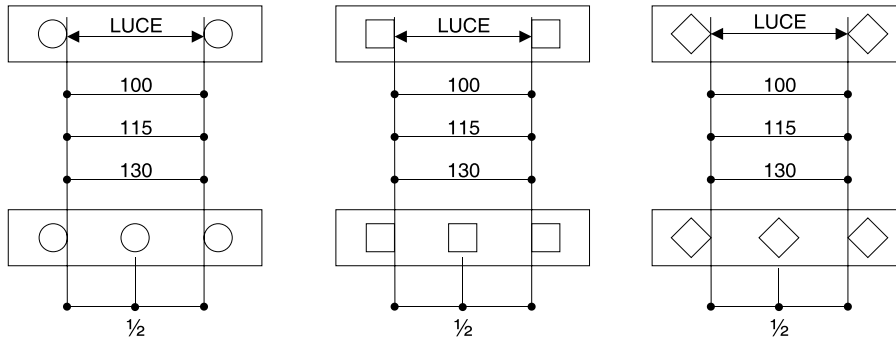

Ogni articolo dei ferri piatti H=2000 mm. Viene fornito con i fori di diametro 13-15-17 mm. Con luce da bordo foro a bordo foro. (Vedi disegno tecnico a lato)

Dimensione piatti:

30x6	35x6	40x6
30x8	35x8	40x8
30x10	35x10	40x10

I piatti art. F156 - F157 - F158 - F159 - F160 - F161 sono battuti ai quattro angoli come da foto. Il foro a centro luce serve per fissare i paletti ridotti.

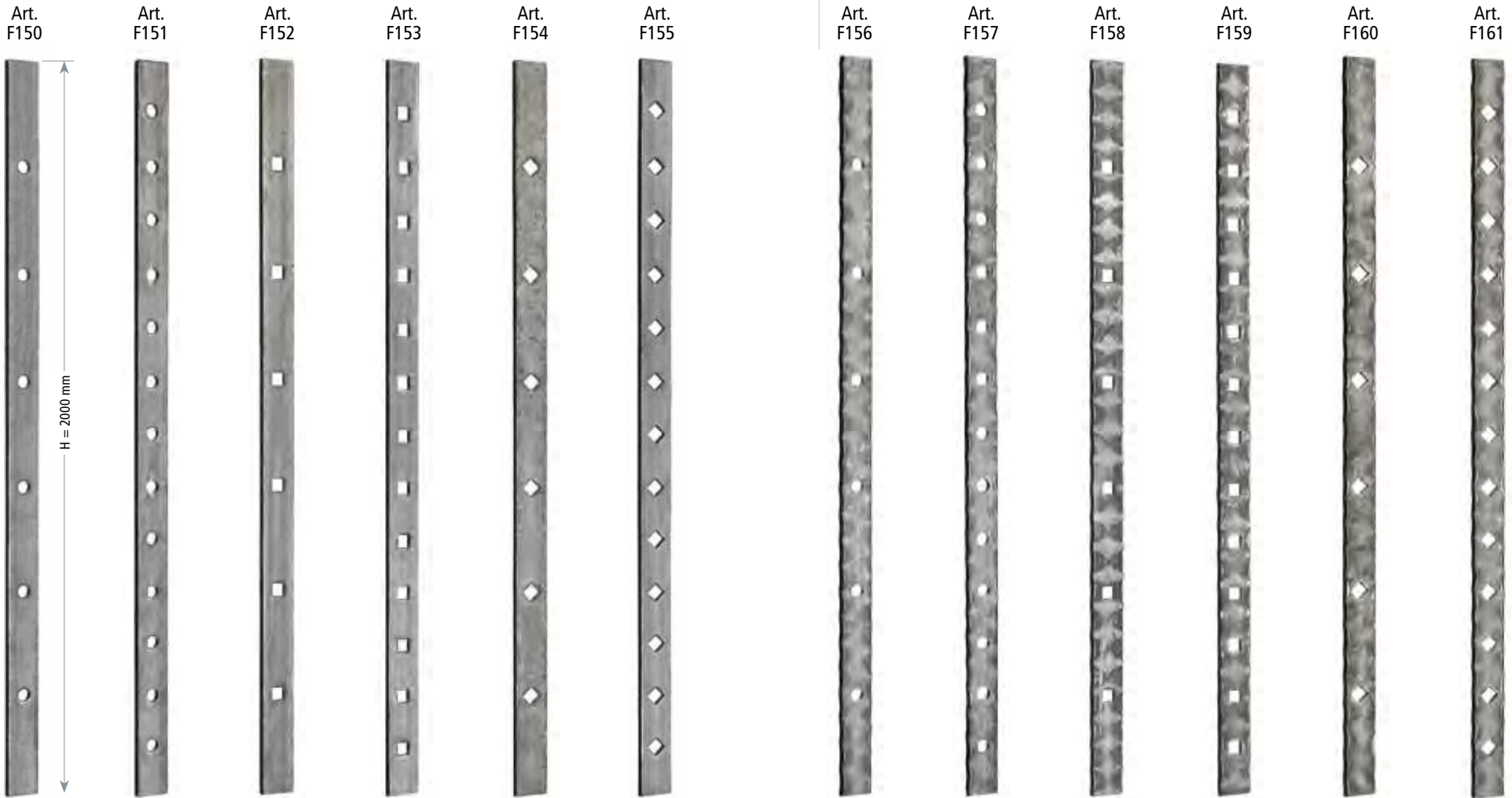

PROFILI BATTUTI

WROUGHT PROFILES

Art. BL 281



Spigolato

SEZIONE



12
14
16
18
20
25
30
35
40

Art. BL 282



Spigolato continuo

TUBOLARE



30 x 30 x 3
35 x 35 x 3
40 x 40 x 3

Art. BL 283



Spigolato

Art. BL 284



Spigolato

SEZIONE



25 x 6
30 x 6
30 x 8
35 x 8
40 x 8
30 x 10
35 x 10
40 x 10

Art. BL 285



Spigolato continuo

I profili battuti vengono forniti in altezze standard di cm. 300 - 600.

Tutto il materiale viene fornito grezzo.

NOVITÀ



Borchie ornamentali in tubo
Ornamental Tube studs

H. 67 X L. 40 mm

27/118	Tondo <i>Round</i>	12,5
27/119	Tondo <i>Round</i>	14,5
27/120	Tondo <i>Round</i>	16,5



Borchie ornamentali in tubo
Ornamental Tube studs

H. 67 X L. 40 mm

27/121	Quadro <i>Square</i>	12,5
H. 67 X L. 40 mm		
27/122	Quadro <i>Square</i>	14,5

ELEMENTI DI ARREDO - ACCESSORI PER LEGNO

FURNISHING ELEMENTS - ACCESSORIES FOR WOOD



Art. L010.08.000
H mm 125
L mm 85
P mm 23



Art. L012.08.000CP
H mm 280
L mm 160
P mm 80



Art. L012.08.000
H mm 280
L mm 160
P mm 80



Art. L013.08.000
H mm 150
L mm 100



Art. L014.08.000CP
H mm 145
L mm 110



Art. L014.08.000
H mm 145
L mm 110



Art. L019.08.000CP
H mm 245
L mm 230



Art. L019.08.000
H mm 245
L mm 230



Art. L349.02.000
H mm 210
L mm 180



Art. L350.02.000CP
H mm 210
L mm 125



Art. L456.02.000
H mm 100
L mm 100



Art. L639.02.000CP
H mm 210
L mm 110



Art. L639.02.000
H mm 210
L mm 110

ELEMENTI DI ARREDO - ACCESSORI PER LEGNO

FURNISHING ELEMENTS - ACCESSORIES FOR WOOD



Art. L017.08.000
H mm 250
L mm 100

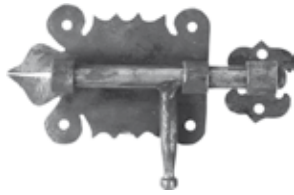

Art. L018.08.000
H mm 60
L mm 90



Art. L446.04.000
H mm 105
L mm 130



Art. L020.08.000
H mm 250
L mm 255



Art. L311.02.000
H mm 340
L mm 115
P mm 105



Art. L312.02.000
H mm 340
L mm 115
P mm 105



Art. L313.02.000
■ 20
H mm 410
L mm 80
P mm 80



Art. L314.02.000
■ 20
H mm 505
L mm 90
P mm 80



Art. L315.02.000
H mm 600
L mm 95
P mm 40



Art. L317.02.000
H mm 615
L mm 100
P mm 80



Art. L318.02.000
H mm 615
L mm 100
P mm 80



Art. L327.02.000
H mm 555
L mm 130
P mm 110



Art. L328.02.000
H mm 555
L mm 130
P mm 110



Art. L329.02.000
H mm 665
L mm 150
P mm 95

ELEMENTI DI ARREDO - ACCESSORI PER LEGNO

FURNISHING ELEMENTS - ACCESSORIES FOR WOOD



Art. L330.02.000
H mm 480
L mm 50
P mm 138



Art. L338.02.000
H mm 260
L mm 85
P mm 45



Art. L347.02.000
H mm 230
L mm 45
P mm 45



Art. L348.02.000
H mm 245
L mm 50
P mm 45



Art. L351.02.000
H mm 350
L mm 90
P mm 75



Art. L352.02.000
H mm 385
L mm 60
P mm 80



Art. L356.02.000
● 20
H mm 240
L mm 60
P mm 80



Art. L358.02.000
■ 20
H mm 295
L mm 55
P mm 80



Art. L359.02.000
H mm 350
L mm 40
P mm 80



Art. L362.02.000
■ 16
H mm 330
L mm 70
P mm 80



Art. L363.02.000
■ 16
H mm 290
L mm 65
P mm 75



Art. L392.02.000CP
● 20
H mm 400
L mm 68
P mm 90



Art. L392.02.000
● 20
H mm 400
L mm 68
P mm 90



Art. L393.02.000CP
● 25
H mm 700
L mm 68
P mm 90

ELEMENTI DI ARREDO - ACCESSORI PER LEGNO

FURNISHING ELEMENTS - ACCESSORIES FOR WOOD



Art. L393.02.000
● 25
H mm 700
L mm 68
P mm 90



Art. L394.02.000CP
● 25
H mm 510
L mm 68
P mm 90



Art. L394.02.000
● 25
H mm 510
L mm 68
P mm 90



Art. L395.02.000CP
● 25
H mm 465
L mm 150
P mm 100



Art. L395.02.000
● 25
H mm 465
L mm 150
P mm 100



Art. L396.02.000CP
◆ 20
H mm 400
L mm 65
P mm 110



Art. L396.02.000
◆ 20
H mm 400
L mm 65
P mm 110



Art. L398.02.000CP
● 25
H mm 450
L mm 68
P mm 80



Art. L398.02.000
● 25
H mm 450
L mm 68
P mm 80



Art. L399.02.000CP
● 20
H mm 415
L mm 68
P mm 85



Art. L399.02.000
● 20
H mm 415
L mm 68
P mm 85



Art. L410.02.000
● 16
H mm 215
L mm 45
P mm 75



Art. L424.02.000CP
H mm 500
L mm 140
P mm 70



Art. L424.02.000
H mm 500
L mm 140
P mm 70

ELEMENTI DI ARREDO - ACCESSORI PER LEGNO

FURNISHING ELEMENTS - ACCESSORIES FOR WOOD



Art. L426.02.000CP
H mm 460
L mm 50
P mm 80



Art. L426.02.000
H mm 460
L mm 50
P mm 80



Art. L427.02.000CP
H mm 460
L mm 50
P mm 80



Art. L427.02.000
H mm 460
L mm 50
P mm 80



Art. L321.02.000
H mm 90
L mm 170



Art. L322.02.000
H mm 90
L mm 170



Art. L323.02.000
H mm 90
L mm 130



Art. L324.02.000
H mm 90
L mm 130



Art. L325.02.000
H mm 65
L mm 110



Art. L657.02.000
H mm 75
L mm 130



Art. L658.02.000
H mm 75
L mm 130



Art. L696.02.000
H mm 65
L mm 130



Art. L697.02.000
H mm 65
L mm 130

ELEMENTI DI ARREDO - ACCESSORI PER LEGNO

FURNISHING ELEMENTS - ACCESSORIES FOR WOOD



Art. L101.92.000
H mm 120
L mm 560



Art. L104.92.000
H mm 260
L mm 540



Art. L112.92.000
H mm 225
L mm 430



Art. L116.92.000
H mm 645
L mm 500



Art. L117.92.000
■ 350 base
H mm 1270
L mm 550
P mm 400



Art. L136.92.000
H mm 360
L mm 500
P mm 185



Art. L102.92.000
H mm 285
L mm 640



Art. L105.92.000
■ 8
H mm 200
L mm 500



Art. L106.94.000
■ 8
H mm 80
L mm 37



Art. L108.94.000
■ 6
H mm 100
L mm 30



Art. L109.94.000
■ 6
H mm 85
L mm 45



Art. L151.94.000
H mm 80
Ø mm 250



Art. L152.94.000
H mm 60
Ø mm 275



Art. L207.93.000
H mm 220
L mm 100

ELEMENTI DI ARREDO - ACCESSORI PER LEGNO

FURNISHING ELEMENTS - ACCESSORIES FOR WOOD



Art. L217.93.000
■ 8
H mm 95
L mm 75



Art. L219.93.000
■ 10
H mm 120
L mm 95



Art. L228.93.000
■ 16x8
H mm 95
L mm 50



Art. L229.93.000
● 8
H mm 110
L mm 120



Art. L236.93.000
■ 10x6
H mm 130
L mm 70



Art. L237.93.000
■ 8x5
H mm 130
L mm 65



Art. L303.93.000CP
H mm 200
L mm 125
P mm 245



Art. L303.93.000
H mm 200
L mm 125
P mm 245



Art. L306.93.000CP
● 6
H mm 80



Art. L306.93.000
● 6
H mm 80



Art. L307.93.000
■ 14x7
H mm 110
L mm 50



Art. L318.93.000CP
● 8
H mm 100



Art. L318.93.000
● 8
H mm 100



Art. L323.93.000
H mm 90
L mm 45
P mm 70

ELEMENTI DI ARREDO - ACCESSORI PER LEGNO
 FURNISHING ELEMENTS - ACCESSORIES FOR WOOD



Art. L325.93.000CP
 ● 8
 H mm 130
 L mm 80
 P mm 30



Art. L325.93.000
 ● 8
 H mm 130
 L mm 80
 P mm 30



Art. L368.93.000
 H mm 120
 L mm 70



Art. L522.93.000CP
 H mm 90
 L mm 40



Art. L522.93.000
 H mm 90
 L mm 40



Art. L523.93.000CP
 H mm 210
 L mm 80



Art. L523.93.000
 H mm 210
 L mm 80



Art. L208.93.000
 H mm 225
 L mm 170



Art. L210.93.000
 H mm 230
 L mm 240



Art. L308.93.000
 ● 12
 H mm 380
 L mm 250



Art. L211.93.000
 ■ 25x8
 H mm 250
 L mm 240



Art. L212.93.000
 ■ 25x8
 H mm 300
 L mm 260



Art. L304.93.000CP
 H mm 330
 L mm 320
 P mm 55



Art. L304.93.000
 H mm 330
 L mm 320
 P mm 55

ELEMENTI DI ARREDO - ACCESSORI PER LEGNO

FURNISHING ELEMENTS - ACCESSORIES FOR WOOD



Art. L201.93.000
H mm 320
L mm 1040

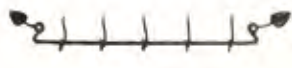

Art. L305.93.000CP
H mm 130
L mm 965



Art. L305.93.000
H mm 130
L mm 965



Art. L399.93.000
H mm 310
L mm 850



Art. L401.93.000
H mm 420
L mm 950



Art. L463.93.000DIY
H mm 390
L mm 1400
P mm 350



Art. L524.93.000CP
H mm 250
L mm 710



Art. L524.93.000
H mm 250
L mm 710



Art. L281.93.000
● 16
H mm 170
L mm 900



Art. L302.92.000
● 16
H mm 710
L mm 660



Art. L303.92.000
■ 20x8
H mm 700
L mm 1190



Art. L304.92.000
● 14
H mm 660
L mm 650



Art. L308.92.000
■ 16x8
H mm 910
L mm 520



Art. L312.92.015
● 16
H mm 800
L mm 1170

ELEMENTI DI ARREDO - ACCESSORI PER LEGNO

FURNISHING ELEMENTS - ACCESSORIES FOR WOOD



Art. L313.92.014
● 14
H mm 570
L mm 800



Art. L314.92.044
■ 20x8
H mm 485
L mm 600



Art. L315.92.216
■ 16x8
H mm 610
L mm 500



Art. L244.04.000
H mm 210
L mm 90
P mm 100



Art. L356.04.000
si adatta a ■ 100
H mm 460
L mm 115



Art. L031.88.119
● 12
H mm 655
L mm 270



Art. L032.88.119
● 12
H mm 655
L mm 270



Art. L035.88.119
● 12
H mm 980
L mm 400



Art. L036.88.119
● 12
H mm 980
L mm 400



Art. L039.88.119
● 12
H mm 880
L mm 580



Art. L040.88.119
● 12
H mm 880
L mm 580



Art. L041.88.119
● 12
H mm 970
L mm 780



Art. L042.88.119
● 12
H mm 970
L mm 780



Art. L050.88.013
● 12
H mm 460
L mm 460

ELEMENTI DI ARREDO - ACCESSORI PER LEGNO

FURNISHING ELEMENTS - ACCESSORIES FOR WOOD



Art. L051.88.013
● 12
H mm 820
L mm 820



Art. L052.88.013
● 12
H mm 710
L mm 710



Art. L053.88.216
■ 16x8
H mm 450
L mm 450



Art. L054.88.216
■ 16x8
H mm 720
L mm 720

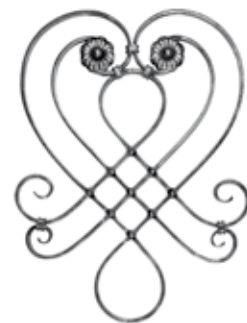

Art. L055.88.216
■ 16x8
H mm 600
L mm 430



Art. L061.88.072
■ 12
H mm 520
L mm 430



Art. L062.88.043
■ 16x8
H mm 480
L mm 400



Art. L062.88.216
■ 16x8
H mm 480
L mm 400

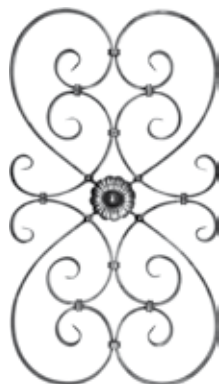

Art. L063.88.216
■ 16x8
H mm 800
L mm 440



Art. L064.88.024
■ 12
H mm 520
L mm 430



Art. L070.88.119
● 12
H mm 940
L mm 500



Art. L071.88.119
● 12
H mm 940
L mm 500



Art. L072.88.119
● 12
H mm 980
L mm 600



Art. L073.88.119
● 12
H mm 980
L mm 600

ELEMENTI DI ARREDO - ACCESSORI PER LEGNO

FURNISHING ELEMENTS - ACCESSORIES FOR WOOD



Art. L101.88.216
 ■ 16x8
 H mm 600
 L mm 270



Art. L102.88.216
 ■ 16x8
 H mm 600
 L mm 270



Art. L103.88.216
 ■ 16x8
 H mm 805
 L mm 320



Art. L104.88.216
 ■ 16x8
 H mm 805
 L mm 320



Art. L113.33.042
 ■ 12x6
 H mm 870
 L mm 350



Art. L202.88.014
 ● 14
 H mm 490
 L mm 185



Art. L203.88.014
 ● 14
 H mm 490
 L mm 185



Art. L259.88.231
 ■ 20x8
 H mm 1010
 L mm 540



Art. L127.92.000CP
 H mm 620
 L mm 510



Art. L127.92.000
 H mm 620
 L mm 510



Art. L128.92.000
 H mm 550
 L mm 390



Art. L129.92.000
 H mm 550
 L mm 390



Art. L130.92.000CP
 H mm 750
 L mm 580



Art. L130.92.000
 H mm 750
 L mm 580

ELEMENTI DI ARREDO - ACCESSORI PER LEGNO

FURNISHING ELEMENTS - ACCESSORIES FOR WOOD



Art. L131.92.000CP
H mm 750
L mm 580



Art. L131.92.000
H mm 750
L mm 580



Art. L132.92.000CP
H mm 620
L mm 510



Art. L132.92.000
H mm 620
L mm 510



Art. L134.92.000
H mm 440
L mm 1060



Art. L307.88.000CP
H mm 500
L mm 510



Art. L308.88.000CP
H mm 650
L mm 680



Art. L308.88.000
H mm 650
L mm 680



Art. L369.04.000
H mm 660
L mm 632
P mm 90



Art. L511.92.000
H mm 345
L mm 456



Art. L512.92.000
H mm 345
L mm 456



Art. L517.92.000
Ø 300



Art. L518.92.000
Ø300



Art. L603.92.000
12x6
Ø 300

ELEMENTI DI ARREDO - ACCESSORI PER LEGNO

FURNISHING ELEMENTS - ACCESSORIES FOR WOOD



Art. L604.92.000
 ■ 12x6
 Ø 300



Art. L615.92.000CP
 H mm 780
 L mm 630



Art. L615.92.000
 H mm 780
 L mm 630



Art. L538.92.000
 H mm 545
 L mm 500



Art. L539.92.000
 H mm 545
 L mm 500



Art. L617.92.000
 ■ 12x6
 Ø 300



Art. L618.92.000
 ■ 12x6
 Ø 300



Art. L623.92.000
 ■ 12x6
 Ø 300



Art. L629.92.000
 H mm 600
 L mm 530



Art. L675.92.000CP
 ■ 10x5
 H mm 480
 L mm 340



Art. L675.92.000
 ■ 10x5
 H mm 480
 L mm 340



Art. L701.92.000
 H mm 260
 L mm 380



Art. L702.92.000
 H mm 430
 L mm 320



Art. L288.93.000
 H mm 990
 L mm 350

ELEMENTI DI ARREDO - ACCESSORI PER LEGNO

FURNISHING ELEMENTS - ACCESSORIES FOR WOOD



Art. L310.92.000
H mm 710
L mm 135



Art. L311.92.000
H mm 660
L mm 195



Art. L329.92.000
H mm 700
L mm 190



Art. L331.92.000
H mm 660
L mm 195



Art. L527.92.000
H mm 190
L mm 315



Art. L528.92.000
H mm 190
L mm 315



Art. L529.92.000
H mm 390
L mm 160



Art. L530.92.000
H mm 390
L mm 160



Art. L531.92.000CP
H mm 65
L mm 65



Art. L531.92.000
H mm 65
L mm 65



Art. L532.92.000CP
H mm 140
L mm 90



Art. L532.92.000
H mm 140
L mm 90



Art. L533.92.000CP
H mm 155
L mm 65



Art. L533.92.000
H mm 155
L mm 65

ELEMENTI DI ARREDO - ACCESSORI PER LEGNO

FURNISHING ELEMENTS - ACCESSORIES FOR WOOD



Art. L534.92.000
H mm 240
L mm 180



Art. L535.92.000
H mm 120
L mm 175



Art. L537.92.000
H mm 70
L mm 100



Art. L545.92.000CP
H mm 230
L mm 110



Art. L545.92.000
H mm 230
L mm 110



Art. L546.92.000CP
H mm 270
L mm 120



Art. L546.92.000
H mm 270
L mm 120



Art. L548.92.000
H mm 240
L mm 155



Art. L551.92.000
H mm 100
L mm 110



Art. L552.92.000CP
H mm 240
L mm 370



Art. L552.92.000
H mm 240
L mm 370



Art. L553.92.000CP
H mm 300
L mm 490



Art. L553.92.000
H mm 300
L mm 490



Art. L561.92.000CP
H mm 90
L mm 170

ELEMENTI DI ARREDO - ACCESSORI PER LEGNO

FURNISHING ELEMENTS - ACCESSORIES FOR WOOD



Art. L561.92.000
H mm 90
L mm 170



Art. L563.92.000
H mm 125
L mm 110



Art. L565.92.000
H mm 160
L mm 220



Art. L566.92.000
H mm 210
L mm 160



Art. L562.92.000
H mm 180
L mm 180



Art. L601.92.000
12x6
Ø 300



Art. L602.92.000
12x6
Ø 300



Art. L605.92.000
12x6
Ø 300



Art. L606.92.000
12x6
Ø 300



Art. L607.92.000
12x6
Ø 300



Art. L608.92.000
12x6
Ø 300



Art. L609.92.000
12x6
Ø 300



Art. L610.92.000
12x6
Ø 300



Art. L613.92.000
12x6
Ø 300

ELEMENTI DI ARREDO - ACCESSORI PER LEGNO

FURNISHING ELEMENTS - ACCESSORIES FOR WOOD



Art. L614.92.000
■ 12x6
Ø 300



Art. L621.92.000
■ 12x6
Ø 300



Art. L622.92.000
■ 12x6
Ø 300



Art. L624.92.000
■ 12x6
Ø 300



Art. L703.92.000
H mm 630
L mm 480



Art. L581.92.000
■ 16x8
Ø 600



Art. L582.92.000
■ 16x8
Ø 600



Art. L583.92.000
■ 16x8
Ø 600



Art. L584.92.000
■ 16x8
Ø 600



Art. L585.92.000
■ 16x8
Ø 600



Art. L586.92.000
■ 16x8
Ø 600



Art. L587.92.000
■ 16x8
Ø 600



Art. L588.92.000
■ 16x8
Ø 600



Art. L589.92.000
■ 16x8
Ø 600

ELEMENTI DI ARREDO - ACCESSORI PER LEGNO

FURNISHING ELEMENTS - ACCESSORIES FOR WOOD



Art. L590.92.000
■ 16x8
Ø 600



Art. L591.92.000
■ 16x8
Ø 600



Art. L592.92.000
■ 16x8
Ø 600



Art. L536.92.000
H mm 210
L mm 90
P mm 60

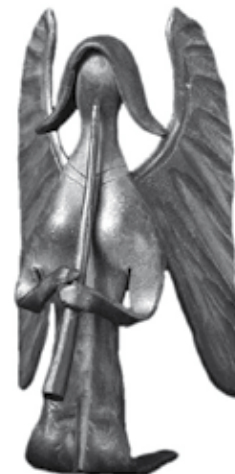

Art. L540.92.000
H mm 200
L mm 120
P mm 110



Art. L543.92.000
H mm 235
L mm 120
P mm 60



Art. L549.92.000
H mm 800
L mm 600
P mm 600



Art. L101.93.000
H mm 460
L mm 160



Art. L106.93.000
H mm 415
L mm 600
P mm 590



Art. L108.93.000CP
H mm 160
L mm 185



Art. L108.93.000
H mm 160
L mm 185



Art. L115.93.000CP
H mm 85
L mm 180



Art. L115.93.000
H mm 85
L mm 180



Art. L222.93.000CP
H mm 245
L mm 145

ELEMENTI DI ARREDO - ACCESSORI PER LEGNO

FURNISHING ELEMENTS - ACCESSORIES FOR WOOD



Art. L223.93.000CP
H mm 105



Art. L223.93.000
H mm 105



Art. L224.93.000CP
H mm 115
L mm 320
P mm 170



Art. L224.93.000
H mm 115
L mm 320
P mm 170



Art. L225.93.000CP
H mm 115
L mm 320
P mm 170



Art. L225.93.000
H mm 115
L mm 320
P mm 170



Art. L226.93.000CP
H mm 155



Art. L226.93.000
H mm 155



Art. L289.93.000CP
H mm 385
L mm 520



Art. L289.93.000
H mm 385
L mm 520



Art. L309.93.000
H mm 965
L mm 345
P mm 345



Art. L311.93.000
H mm 1490
L mm 445
P mm 330



Art. L312.93.000CP
H mm 265



Art. L312.93.000
H mm 265

ELEMENTI DI ARREDO - ACCESSORI PER LEGNO

FURNISHING ELEMENTS - ACCESSORIES FOR WOOD



Art. L321.93.000
H mm 340
L mm 110



Art. L521.93.000CP
H mm 330
L mm 180



Art. L521.93.000
H mm 330
L mm 180



Art. L526.93.000
H mm 620
L mm 255



Art. L527.93.000
H mm 930
L mm 255



Art. L528.93.000
H mm 1235
L mm 255



Art. L529.93.000CP
H mm 400
L mm 130



Art. L529.93.000
H mm 400
L mm 130



Art. L530.93.000CP
H mm 455
L mm 130



Art. L530.93.000
H mm 455
L mm 130



Art. L531.93.000CP
H mm 535
L mm 130



Art. L531.93.000
H mm 535
L mm 130



Art. L103.93.000CP
● 8
H mm 190
L mm 110



Art. L103.93.000
● 8
H mm 190
L mm 110

ELEMENTI DI ARREDO - ACCESSORI PER LEGNO

FURNISHING ELEMENTS - ACCESSORIES FOR WOOD



Art. L115.92.000
H mm 210
L mm 410



Art. L302.93.000
H mm 1270
L mm 345



Art. L313.93.000
H mm 1405
L mm 460
P mm 400



Art. L319.93.000
H mm 110
L mm 150



Art. L248.93.000
● 12
H mm 125
L mm 500
P mm 80



Art. L249.93.000
● 12
H mm 125
L mm 650
P mm 80



Art. L250.93.000
● 12
H mm 125
L mm 900
P mm 80



Art. L264.93.000
H mm 260
L mm 320



Art. L246.93.000
● 12
H mm 1300
L mm 560



Art. L317.93.000
● 12
H mm 1125
L mm 445
P mm 390



Art. L327.93.000
H mm 400
L mm 500



Art. L474.93.000DIY
H mm 1260
L mm 375



Art. L478.93.000DIY
H mm 700
L mm 320
P mm 240



Art. L481.93.000DIY
H mm 900
L mm 310
P mm 300

ELEMENTI DI ARREDO - ACCESSORI PER LEGNO

FURNISHING ELEMENTS - ACCESSORIES FOR WOOD



Art. L256.93.000
H mm 540
Ø 710



Art. L257.93.000
H mm 500
L mm 820



Art. L260.93.000
■ 16
H mm 355
L mm 570
P mm 280



Art. L261.93.000
H mm 490
L mm 530
P mm 280



Art. L287.93.000
H mm 130
L mm 220



Art. L315.93.000CP
H mm 710
L mm 440
P mm 230



Art. L315.93.000
H mm 710
L mm 440
P mm 230



Art. L326.93.000
H mm 950
L mm 450
P mm 450



Art. L328.93.000CP
H mm 1050
L mm 700
P mm 250



Art. L328.93.000
H mm 1050
L mm 700
P mm 250



Art. L412.93.000
H mm 1040
L mm 500
P mm 340



Art. L525.93.000CP
H mm 740
L mm 330



Art. L525.93.000
H mm 740
L mm 330



Art. L442.93.000DIY
H mm 970
L mm 520
P mm 520



Art. L476.93.000DIY
 H mm 970
 L mm 530
 P mm 485

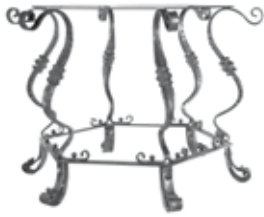

Art. L451.93.000DIY
 H mm 800
 Ø 200



Art. L452.93.000DIY
 H mm 785
 L mm 710
 P mm 710



Art. L453.93.000DIY
 H mm 800
 Ø 850



Art. L454.93.000DIY
 H mm 415
 L mm 1335
 P mm 845



Art. L457.93.000DIY
 H mm 430
 L mm 670
 P mm 670



Art. L473.93.000DIY
 H mm 565
 L mm 640
 P mm 640



Art. L477.93.000DIY
 H mm 585
 L mm 850
 P mm 530



Art. L490.93.000DIY
 H mm 810
 L mm 1340
 P mm 680

INDICE ARTICOLI ALMANACCO TECNICO

INDEX ALMANAC TECHNICAL ARTICLES

Art. 1 - pag. 271	Art. 28 - pag. 273	Art. 56 - pag. 275	Art. 102 - pag. 263	Art. 171 - pag. 260	Art. 1051 - pag. 259
Art. 2 - pag. 271	Art. 29/C - pag. 273	Art. 57 - pag. 275	Art. 103 - pag. 267	Art. 172 - pag. 260	Art. 1051 - pag. 302
Art. 3 - pag. 271	Art. 29/R - pag. 273	Art. 58 - pag. 275	Art. 104 - pag. 267	Art. 175 - pag. 267	Art. 1062 - pag. 264
Art. 4D - pag. 271	Art. 30 - pag. 273	Art. 59 - pag. 275	Art. 111 - pag. 260	Art. 178 - pag. 267	Art. 1063 - pag. 264
Art. 4S - pag. 271	Art. 30 FASCETTA - pag. 282	Art. 60 - pag. 275	Art. 112 - pag. 260	Art. 180 - pag. 268	Art. 1066 - pag. 264
Art. 5D - pag. 271	Art. 31 - pag. 273	Art. 61 - pag. 275	Art. 113 - pag. 260	Art. 181 - pag. 268	Art. 1067 - pag. 264
Art. 5S - pag. 271	Art. 32 - pag. 274	Art. 62 - pag. 275	Art. 121 - pag. 261	Art. 182 - pag. 268	Art. 1074 - pag. 264
Art. 6 (1062) - pag. 271	Art. 33 - pag. 274	Art. 63 - pag. 275	Art. 121 - pag. 263	Art. 183 - pag. 268	Art. 1075 - pag. 264
Art. 7 - pag. 271	Art. 34 - pag. 274	Art. 64 - pag. 275	Art. 121-A - pag. 263	Art. 226 - pag. 287	Art. 1075/C - pag. 264
Art. 8 - pag. 271	Art. 35 - pag. 274	Art. 65 (1074) - pag. 275	Art. 122 - pag. 261	Art. 252 RIBATTINO - pag. 282	Art. 1076 - pag. 264
Art. 9 - pag. 271	Art. 36 (1066) - pag. 274	Art. 66 (1078) - pag. 275	Art. 122 - pag. 263	Art. 341 - pag. 289	Art. 1077 - pag. 264
Art. 10/C - pag. 271	Art. 37 (1077) - pag. 274	Art. 70 - pag. 276	Art. 123 - pag. 267	Art. 342 - pag. 289	Art. 1078 - pag. 264
Art. 10/R - pag. 271	Art. 40 - pag. 282	Art. 71 - pag. 276	Art. 124 - pag. 267	Art. 343 - pag. 289	Art. 1104 - pag. 242
Art. 11 - pag. 271	Art. 41 - pag. 282	Art. 72 - pag. 276	Art. 131 - pag. 260	Art. 344 - pag. 288	Art. 1105 - pag. 242
Art. 12 - pag. 272	Art. 42 - pag. 282	Art. 73D - pag. 276	Art. 132 - pag. 260	Art. 345 - pag. 288	Art. 1106 - pag. 242
Art. 13 - pag. 272	Art. 43 - pag. 282	Art. 73S - pag. 276	Art. 133 - pag. 260	Art. 346 - pag. 288	Art. 1107 - pag. 242
Art. 14 - pag. 272	Art. 44 - pag. 282	Art. 74D - pag. 276	Art. 141 - pag. 261	Art. 348 - pag. 289	Art. 1112 - pag. 242
Art. 15 - pag. 272	Art. 45 - pag. 282	Art. 74S - pag. 276	Art. 141 - pag. 263	Art. 350 - pag. 283	Art. 1113 - pag. 242
Art. 16 (1062) - pag. 272	Art. 46 - pag. 282	Art. 75 - pag. 276	Art. 141-A - pag. 263	Art. 360 - pag. 283	Art. 1114 - pag. 242
Art. 17 (1076) - pag. 272	Art. 47 - pag. 282	Art. 76 - pag. 276	Art. 142 - pag. 261	Art. 560 - pag. 282	Art. 1115 - pag. 242
Art. 20 - pag. 272	Art. 48 - pag. 282	Art. 77 - pag. 276	Art. 142 - pag. 263	Art. 1021 - pag. 259	Art. 1128 - pag. 242
Art. 21 - pag. 272	Art. 49 - pag. 282	Art. 78 - pag. 276	Art. 143 - pag. 267	Art. 1023 - pag. 259	Art. 1129 - pag. 242
Art. 22 - pag. 272	Art. 50 - pag. 274	Art. 79 - pag. 276	Art. 144 - pag. 267	Art. 1027 - pag. 259	Art. 1130 - pag. 242
Art. 23D - pag. 272	Art. 50 RICCILOLO - pag. 282	Art. 80 - pag. 277	Art. 151 - pag. 260	Art. 1031 - pag. 262	Art. 1131 - pag. 242
Art. 23S - pag. 272	Art. 51 - pag. 274	Art. 81 - pag. 277	Art. 152 - pag. 260	Art. 1033 - pag. 262	Art. 1174 - pag. 257
Art. 24D - pag. 272	Art. 52 - pag. 274	Art. 82 - pag. 277	Art. 161 - pag. 261	Art. 1037 - pag. 262	Art. 1175 - pag. 257
Art. 24S - pag. 272	Art. 53D - pag. 274	Art. 83 - pag. 277	Art. 161 - pag. 263	Art. 1041 - pag. 259	Art. 1181 - pag. 251
Art. 25 (1066) - pag. 272	Art. 53S - pag. 274	Art. 101 - pag. 261	Art. 162 - pag. 261	Art. 1043 - pag. 259	Art. 1183 - pag. 251
Art. 25 (1066) - pag. 273	Art. 54D - pag. 274	Art. 101 - pag. 263	Art. 162 - pag. 263	Art. 1047 - pag. 259	Art. 1187 - pag. 251
Art. 26 - pag. 273	Art. 54S - pag. 274	Art. 101-A - pag. 263	Art. 163 - pag. 267	Art. 1050 - pag. 259	Art. 1209 - pag. 251
Art. 27 - pag. 273	Art. 55 (1074) - pag. 274	Art. 102 - pag. 261	Art. 164 - pag. 267	Art. 1050 - pag. 302	Art. 1210 - pag. 251

Art. 1211 - pag. 251	Art. AM1695 - pag. 269	Art. BL67 - pag. 253	Art. BL86 - pag. 278	Art. BL127 - pag. 265	Art. BL160 - pag. 244
Art. 1212 - pag. 251	Art. AM1695 PORTAFIORI - pag. 269	Art. BL67 - pag. 258	Art. BL87 - pag. 278	Art. BL130 - pag. 242	Art. BL161 - pag. 244
Art. 1213 - pag. 251	Art. AM1705 - pag. 269	Art. BL68 - pag. 258	Art. BL88 - pag. 278	Art. BL131 - pag. 242	Art. BL162 - pag. 244
Art. 1214 - pag. 251	Art. AM1705 PORTAFIORI - pag. 269	Art. BL69 - pag. 253	Art. BL89 - pag. 278	Art. BL132 - pag. 242	Art. BL163 - pag. 244
Art. 1216 - pag. 251	Art. B9 - pag. 264	Art. BL69 - pag. 258	Art. BL90 - pag. 278	Art. BL133 - pag. 242	Art. BL164 - pag. 244
Art. 1217 - pag. 251	Art. B49 - pag. 262	Art. BL70 - pag. 251	Art. BL91 - pag. 278	Art. BL134 - pag. 242	Art. BL165 - pag. 244
Art. 1218 - pag. 251	Art. B79 - pag. 250	Art. BL70 - pag. 262	Art. BL92 - pag. 278	Art. BL135 - pag. 242	Art. BL166 - pag. 244
Art. AM190-A - pag. 263	Art. B80 - pag. 250	Art. BL71 - pag. 251	Art. BL95 - pag. 265	Art. BL136 - pag. 242	Art. BL167 - pag. 244
Art. AM1014 - pag. 268	Art. BL49 - pag. 259	Art. BL71 - pag. 262	Art. BL96 - pag. 265	Art. BL137 - pag. 243	Art. BL168 - pag. 244
Art. AM1015 - pag. 268	Art. BL50 - pag. 259	Art. BL72 - pag. 251	Art. BL97 - pag. 265	Art. BL138 - pag. 243	Art. BL169 - pag. 244
Art. AM1025 - pag. 270	Art. BL51 - pag. 259	Art. BL72 - pag. 262	Art. BL98 - pag. 265	Art. BL139 - pag. 243	Art. BL170 - pag. 244
Art. AM1026 - pag. 270	Art. BL52 - pag. 259	Art. BL73 - pag. 251	Art. BL99 - pag. 265	Art. BL140 - pag. 243	Art. BL171 - pag. 244
Art. AM1104 - pag. 268	Art. BL53 - pag. 259	Art. BL73 - pag. 262	Art. BL100 - pag. 265	Art. BL141 - pag. 243	Art. BL172 - pag. 244
Art. AM1105 - pag. 268	Art. BL54 - pag. 259	Art. BL74 - pag. 251	Art. BL101 - pag. 265	Art. BL142 - pag. 243	Art. BL173 - pag. 245
Art. AM1115 - pag. 268	Art. BL55 - pag. 259	Art. BL74 - pag. 262	Art. BL102 - pag. 265	Art. BL143 - pag. 243	Art. BL174 - pag. 245
Art. AM1145 - pag. 270	Art. BL56 - pag. 259	Art. BL75 - pag. 251	Art. BL103 - pag. 265	Art. BL144 - pag. 243	Art. BL175 - pag. 245
Art. AM1146 - pag. 270	Art. BL57 - pag. 259	Art. BL75 - pag. 262	Art. BL104 - pag. 265	Art. BL145 - pag. 243	Art. BL176 - pag. 245
Art. AM1185 - pag. 267	Art. BL58 - pag. 259	Art. BL76 - pag. 251	Art. BL105 - pag. 265	Art. BL146 - pag. 243	Art. BL177 - pag. 245
Art. AM1235 - pag. 268	Art. BL59 - pag. 253	Art. BL76 - pag. 262	Art. BL106 - pag. 265	Art. BL147 - pag. 243	Art. BL178 - pag. 245
Art. AM1245 - pag. 268	Art. BL59 - pag. 258	Art. BL77 - pag. 251	Art. BL107 - pag. 265	Art. BL148 - pag. 243	Art. BL179 - pag. 245
Art. AM1265 - pag. 268	Art. BL60 - pag. 258	Art. BL77 - pag. 262	Art. BL108 - pag. 265	Art. BL149 - pag. 243	Art. BL180 - pag. 245
Art. AM1325 - pag. 268	Art. BL61 - pag. 253	Art. BL78 - pag. 251	Art. BL109 - pag. 265	Art. BL150 - pag. 243	Art. BL181 - pag. 245
Art. AM1435 - pag. 267	Art. BL61 - pag. 258	Art. BL78 - pag. 262	Art. BL110 - pag. 265	Art. BL151 - pag. 243	Art. BL182 - pag. 245
Art. AM1455 - pag. 253	Art. BL62 - pag. 258	Art. BL80 - pag. 251	Art. BL111 - pag. 265	Art. BL152 - pag. 243	Art. BL183 - pag. 245
Art. AM1655 - pag. 269	Art. BL63 - pag. 253	Art. BL80 - pag. 262	Art. BL112 - pag. 265	Art. BL153 - pag. 244	Art. BL184 - pag. 245
Art. AM1656 - pag. 269	Art. BL63 - pag. 258	Art. BL81 - pag. 278	Art. BL115 - pag. 265	Art. BL154 - pag. 244	Art. BL185 - pag. 245
Art. AM1665 - pag. 269	Art. BL64 - pag. 258	Art. BL82 - pag. 278	Art. BL122 - pag. 265	Art. BL155 - pag. 244	Art. BL186 - pag. 245
Art. AM1675 - pag. 269	Art. BL65 - pag. 253	Art. BL83 - pag. 278	Art. BL122 - pag. 268	Art. BL156 - pag. 244	Art. BL187 - pag. 246
Art. AM1685 - pag. 269	Art. BL65 - pag. 258	Art. BL84 - pag. 278	Art. BL124 - pag. 264	Art. BL157 - pag. 244	Art. BL188 - pag. 246
Art. AM1685 PORTAFIORI - pag. 269	Art. BL66 - pag. 253	Art. BL85 - pag. 263	Art. BL124 - pag. 265	Art. BL158 - pag. 244	Art. BL189 - pag. 246
Art. AM1686 - pag. 269	Art. BL66 - pag. 258	Art. BL85 - pag. 278	Art. BL124 - pag. 268	Art. BL159 - pag. 244	Art. BL190 - pag. 246

INDICE ARTICOLI ALMANACCO TECNICO

INDEX ALMANAC TECHNICAL ARTICLES

- | | | | | | |
|------------------------------|------------------------------|------------------------------|------------------------------|-----------------------------------|-------------------------------|
| Art. BL191 - pag. 246 | Art. BL244 - pag. 252 | Art. BL277 - pag. 254 | Art. BL317 - pag. 284 | Art. C215 - pag. 290 | Art. C402 - pag. 295 |
| Art. BL192 - pag. 246 | Art. BL245 - pag. 250 | Art. BL280 - pag. 254 | Art. BL318 - pag. 284 | Art. C223 - pag. 290 | Art. C405 - pag. 295 |
| Art. BL193 - pag. 246 | Art. BL245 - pag. 251 | Art. BL280 - pag. 289 | Art. BL319 - pag. 281 | Art. C238 - pag. 291 | Art. C407 - pag. 295 |
| Art. BL194 - pag. 246 | Art. BL245 - pag. 252 | Art. BL281 - pag. 304 | Art. BL320 - pag. 285 | Art. C305 - pag. 291 | Art. C417 - pag. 295 |
| Art. BL195 - pag. 246 | Art. BL246 - pag. 252 | Art. BL282 - pag. 304 | Art. BL320 - pag. 287 | Art. C340 - pag. 291 | Art. C425 - pag. 296 |
| Art. BL196 - pag. 246 | Art. BL247 - pag. 252 | Art. BL283 - pag. 304 | Art. BL321 - pag. 285 | Art. C345MAXI - pag. 291 | Art. C427 - pag. 296 |
| Art. BL197 - pag. 246 | Art. BL248 - pag. 252 | Art. BL284 - pag. 304 | Art. BL323 - pag. 288 | Art. C345RG - pag. 291 | Art. C430 - pag. 296 |
| Art. BL198 - pag. 246 | Art. BL249 - pag. 252 | Art. BL285 - pag. 304 | Art. BL323 - pag. 289 | Art. C345RGL - pag. 291 | Art. C435 - pag. 296 |
| Art. BL199 - pag. 246 | Art. BL250 - pag. 255 | Art. BL290 - pag. 266 | Art. BL350 - pag. 288 | Art. C345RGLPST - pag. 292 | Art. C437 - pag. 296 |
| Art. BL200 - pag. 246 | Art. BL251 - pag. 255 | Art. BL291 - pag. 266 | Art. BL350 - pag. 289 | Art. C346G - pag. 292 | Art. C440 - pag. 296 |
| Art. BL210 - pag. 257 | Art. BL252 - pag. 255 | Art. BL292 - pag. 266 | Art. BL351 - pag. 289 | Art. C346MAXI - pag. 292 | Art. C442 - pag. 297 |
| Art. BL212 - pag. 257 | Art. BL253 - pag. 255 | Art. BL293 - pag. 266 | Art. BL370 - pag. 254 | Art. C346P - pag. 292 | Art. C447 - pag. 297 |
| Art. BL214 - pag. 257 | Art. BL254 - pag. 255 | Art. BL294 - pag. 266 | Art. BL370 - pag. 289 | Art. C348 - pag. 288 | Art. C449 - pag. 297 |
| Art. BL215 - pag. 257 | Art. BL255 - pag. 255 | Art. BL295 - pag. 266 | Art. BM321 - pag. 285 | Art. C348 - pag. 292 | Art. C450 - pag. 297 |
| Art. BL220 - pag. 257 | Art. BL256 - pag. 255 | Art. BL296 - pag. 266 | Art. BM321 - pag. 287 | Art. C349 - pag. 288 | Art. C461 - pag. 297 |
| Art. BL221 - pag. 257 | Art. BL257 - pag. 255 | Art. BL297 - pag. 266 | Art. BM322 - pag. 285 | Art. C349 - pag. 292 | Art. C462 - pag. 297 |
| Art. BL222 - pag. 257 | Art. BL258 - pag. 255 | Art. BL298 - pag. 266 | Art. BM322 - pag. 287 | Art. C350 - pag. 293 | Art. C465 - pag. 298 |
| Art. BL223 - pag. 257 | Art. BL259 - pag. 256 | Art. BL300 - pag. 253 | Art. BT1 - pag. 257 | Art. C352 - pag. 293 | Art. C468 - pag. 298 |
| Art. BL224 - pag. 257 | Art. BL260 - pag. 256 | Art. BL301 - pag. 253 | Art. BT43D - pag. 257 | Art. C352F - pag. 293 | Art. C730 - pag. 298 |
| Art. BL225 - pag. 257 | Art. BL261 - pag. 256 | Art. BL302 - pag. 253 | Art. C40 - pag. 284 | Art. C354 - pag. 293 | Art. C731 - pag. 298 |
| Art. BL226 - pag. 257 | Art. BL262 - pag. 256 | Art. BL303 - pag. 253 | Art. C41 - pag. 284 | Art. C355 - pag. 293 | Art. C750 - pag. 298 |
| Art. BL227 - pag. 257 | Art. BL263 - pag. 256 | Art. BL303 - pag. 258 | Art. C42 - pag. 284 | Art. C376 - pag. 293 | Art. C752 - pag. 298 |
| Art. BL235 - pag. 252 | Art. BL266 - pag. 256 | Art. BL304 - pag. 253 | Art. C43 - pag. 284 | Art. C378 - pag. 294 | Art. C805 - pag. 299 |
| Art. BL236 - pag. 252 | Art. BL267 - pag. 256 | Art. BL304 - pag. 258 | Art. C45 - pag. 284 | Art. C380 - pag. 294 | Art. C810 - pag. 299 |
| Art. BL237 - pag. 252 | Art. BL270 - pag. 254 | Art. BL308 - pag. 287 | Art. C46 - pag. 284 | Art. C380F - pag. 288 | Art. C822NY - pag. 299 |
| Art. BL238 - pag. 252 | Art. BL271 - pag. 254 | Art. BL309 - pag. 287 | Art. C47 - pag. 284 | Art. C380F - pag. 294 | Art. C848 - pag. 299 |
| Art. BL239 - pag. 252 | Art. BL272 - pag. 254 | Art. BL310 - pag. 284 | Art. C48 - pag. 284 | Art. C381 - pag. 294 | Art. C855 - pag. 299 |
| Art. BL240 - pag. 252 | Art. BL273 - pag. 254 | Art. BL311 - pag. 284 | Art. C100 - pag. 290 | Art. C382 - pag. 294 | Art. C857 - pag. 288 |
| Art. BL241 - pag. 252 | Art. BL274 - pag. 254 | Art. BL312 - pag. 284 | Art. C175 - pag. 290 | Art. C383 - pag. 294 | Art. C857 - pag. 299 |
| Art. BL242 - pag. 252 | Art. BL275 - pag. 254 | Art. BL315 - pag. 284 | Art. C185 - pag. 290 | Art. C391 - pag. 295 | Art. C858 - pag. 300 |
| Art. BL243 - pag. 252 | Art. BL276 - pag. 254 | Art. BL316 - pag. 284 | Art. C206 - pag. 290 | Art. C400 - pag. 295 | Art. C861P - pag. 300 |

Art. C861T - pag. 288	Art. D37 - pag. 279	Art. F5 - pag. 264	Art. F65 - pag. 250	Art. F156 - pag. 303	Art. FC182-11 - pag. 248
Art. C861T - pag. 300	Art. D38 - pag. 279	Art. F6 - pag. 264	Art. F66 - pag. 250	Art. F157 - pag. 303	Art. FC182-12 - pag. 248
Art. C876 - pag. 300	Art. D39 - pag. 279	Art. F7 - pag. 264	Art. F67 - pag. 250	Art. F158 - pag. 303	Art. FC183-3 - pag. 248
Art. C878 - pag. 300	Art. D50 - pag. 280	Art. F8 - pag. 264	Art. F68 - pag. 250	Art. F159 - pag. 303	Art. FC183-4 - pag. 248
Art. C901 - pag. 300	Art. D51 - pag. 280	Art. F10 - pag. 264	Art. F69 - pag. 250	Art. F160 - pag. 303	Art. FC183-5 - pag. 248
Art. C902 - pag. 301	Art. D52 - pag. 280	Art. F11 - pag. 264	Art. F70 - pag. 250	Art. F161 - pag. 303	Art. FC183-6 - pag. 248
Art. C904 - pag. 301	Art. D53 - pag. 280	Art. F12 - pag. 264	Art. F71 - pag. 250	Art. FC180-3 - pag. 247	Art. FC183-7 - pag. 248
Art. C906 - pag. 301	Art. D54 - pag. 280	Art. F20 - pag. 258	Art. F72 - pag. 250	Art. FC180-4 - pag. 247	Art. FC183-8 - pag. 248
Art. C2010 - pag. 301	Art. D55 - pag. 280	Art. F21 - pag. 258	Art. F73 - pag. 250	Art. FC180-5 - pag. 247	Art. FC183-10 - pag. 248
Art. D2 - pag. 281	Art. D56 - pag. 280	Art. F22 - pag. 258	Art. F74 - pag. 250	Art. FC180-6 - pag. 247	Art. FC183-11 - pag. 248
Art. D3 - pag. 281	Art. D57 - pag. 280	Art. F23 - pag. 258	Art. F75 - pag. 250	Art. FC180-7 - pag. 247	Art. FC183-12 - pag. 248
Art. D6 - pag. 281	Art. D58 - pag. 280	Art. F24 - pag. 258	Art. F76 - pag. 250	Art. FC180-8 - pag. 247	Art. FC184-3 - pag. 249
Art. D10 - pag. 279	Art. D59 - pag. 280	Art. F25 - pag. 258	Art. F77 - pag. 250	Art. FC180-10 - pag. 247	Art. FC184-4 - pag. 249
Art. D11 - pag. 279	Art. D60 - pag. 280	Art. F26 - pag. 258	Art. F78 - pag. 250	Art. FC180-11 - pag. 247	Art. FC184-5 - pag. 249
Art. D12 - pag. 279	Art. D61 - pag. 280	Art. F27 - pag. 258	Art. F90 - pag. 281	Art. FC180-12 - pag. 247	Art. FC184-6 - pag. 249
Art. D13 - pag. 279	Art. D70 - pag. 280	Art. F28 - pag. 258	Art. F91 - pag. 281	Art. FC181-3 - pag. 247	Art. FC184-7 - pag. 249
Art. D14 - pag. 279	Art. D71 - pag. 280	Art. F29B - pag. 258	Art. F92 - pag. 281	Art. FC181-4 - pag. 247	Art. FC184-8 - pag. 249
Art. D15 - pag. 279	Art. D72 - pag. 280	Art. F40 - pag. 262	Art. F93 - pag. 281	Art. FC181-5 - pag. 247	Art. FC184-10 - pag. 249
Art. D16 - pag. 279	Art. D73 - pag. 280	Art. F41 - pag. 262	Art. F94 - pag. 281	Art. FC181-6 - pag. 247	Art. FC184-11 - pag. 249
Art. D17 - pag. 279	Art. D74 - pag. 280	Art. F42 - pag. 262	Art. F95 - pag. 281	Art. FC181-7 - pag. 247	Art. FC184-12 - pag. 249
Art. D21 - pag. 279	Art. D75 - pag. 280	Art. F43 - pag. 262	Art. F96 - pag. 281	Art. FC181-8 - pag. 247	Art. FC245-3 - pag. 249
Art. D22 - pag. 279	Art. D76 - pag. 280	Art. F44 - pag. 262	Art. F97 - pag. 281	Art. FC181-10 - pag. 247	Art. FC245-4 - pag. 249
Art. D23 - pag. 279	Art. D77 - pag. 280	Art. F45 - pag. 262	Art. F98 - pag. 281	Art. FC181-11 - pag. 247	Art. FC245-5 - pag. 249
Art. D24 - pag. 279	Art. D78 - pag. 280	Art. F46 - pag. 262	Art. F103 - pag. 279	Art. FC181-12 - pag. 247	Art. FC245-6 - pag. 249
Art. D30 - pag. 279	Art. D79 - pag. 280	Art. F47 - pag. 262	Art. F104 - pag. 279	Art. FC182-3 - pag. 248	Art. FC245-7 - pag. 249
Art. D31 - pag. 279	Art. D80 - pag. 280	Art. F48 - pag. 262	Art. F150 - pag. 303	Art. FC182-4 - pag. 248	Art. FC245-8 - pag. 249
Art. D32 - pag. 279	Art. D81 - pag. 280	Art. F60 - pag. 250	Art. F151 - pag. 303	Art. FC182-5 - pag. 248	Art. FC245-10 - pag. 249
Art. D33 - pag. 279	Art. F1 - pag. 264	Art. F61 - pag. 250	Art. F152 - pag. 303	Art. FC182-6 - pag. 248	Art. FC245-11 - pag. 249
Art. D34 - pag. 279	Art. F2 - pag. 264	Art. F62 - pag. 250	Art. F153 - pag. 303	Art. FC182-7 - pag. 248	Art. FC245-12 - pag. 249
Art. D35 - pag. 279	Art. F3 - pag. 264	Art. F63 - pag. 250	Art. F154 - pag. 303	Art. FC182-8 - pag. 248	Art. G27/118 - pag. 305
Art. D36 - pag. 279	Art. F4 - pag. 264	Art. F64 - pag. 250	Art. F155 - pag. 303	Art. FC182-10 - pag. 248	Art. G27/119 - pag. 305

INDICE ARTICOLI ALMANACCO TECNICO

INDEX ALMANAC TECHNICAL ARTICLES

Art. G27/120 - pag. 305	Art. L051.88.013 - pag. 316	Art. L112.92.000 - pag. 311	Art. L222.93.000CP - pag. 324	Art. L303.92.000 - pag. 314	Art. L315.92.216 - pag. 315
Art. G27/121 - pag. 305	Art. L052.88.013 - pag. 316	Art. L113.33.042 - pag. 317	Art. L223.93.000 - pag. 325	Art. L303.93.000 - pag. 312	Art. L315.93.000 - pag. 328
Art. G27/122 - pag. 305	Art. L053.88.216 - pag. 316	Art. L115.92.000 - pag. 327	Art. L223.93.000CP - pag. 325	Art. L303.93.000CP - pag. 312	Art. L315.93.000CP - pag. 328
Art. G30/001/DG - pag. 286	Art. L054.88.216 - pag. 316	Art. L115.93.000 - pag. 324	Art. L224.93.000 - pag. 325	Art. L304.92.000 - pag. 314	Art. L317.02.000 - pag. 307
Art. G30/001/SG - pag. 286	Art. L055.88.216 - pag. 316	Art. L115.93.000CP - pag. 324	Art. L224.93.000CP - pag. 325	Art. L304.93.000 - pag. 313	Art. L317.93.000 - pag. 327
Art. G30/002/DG - pag. 286	Art. L061.88.072 - pag. 316	Art. L116.92.000 - pag. 311	Art. L225.93.000 - pag. 325	Art. L304.93.000CP - pag. 313	Art. L318.02.000 - pag. 307
Art. G30/002/SG - pag. 286	Art. L062.88.043 - pag. 316	Art. L117.92.000 - pag. 311	Art. L225.93.000CP - pag. 325	Art. L305.93.000 - pag. 314	Art. L318.93.000 - pag. 312
Art. G30/003/G - pag. 286	Art. L062.88.216 - pag. 316	Art. L127.92.000 - pag. 317	Art. L226.93.000 - pag. 325	Art. L305.93.000CP - pag. 314	Art. L318.93.000CP - pag. 312
Art. G30/004/G - pag. 286	Art. L063.88.216 - pag. 316	Art. L127.92.000CP - pag. 317	Art. L226.93.000CP - pag. 325	Art. L306.93.000 - pag. 312	Art. L319.93.000 - pag. 327
Art. G30/005/G - pag. 286	Art. L064.88.024 - pag. 316	Art. L128.92.000 - pag. 317	Art. L228.93.000 - pag. 312	Art. L306.93.000CP - pag. 312	Art. L321.02.000 - pag. 310
Art. G30/006/G - pag. 286	Art. L070.88.119 - pag. 316	Art. L129.92.000 - pag. 317	Art. L229.93.000 - pag. 312	Art. L307.88.000CP - pag. 318	Art. L321.93.000 - pag. 326
Art. L010.08.000 - pag. 306	Art. L071.88.119 - pag. 316	Art. L130.92.000 - pag. 317	Art. L236.93.000 - pag. 312	Art. L307.93.000 - pag. 312	Art. L322.02.000 - pag. 310
Art. L012.08.000 - pag. 306	Art. L072.88.119 - pag. 316	Art. L130.92.000CP - pag. 317	Art. L237.93.000 - pag. 312	Art. L308.88.000 - pag. 318	Art. L323.02.000 - pag. 310
Art. L012.08.000CP - pag. 306	Art. L073.88.119 - pag. 316	Art. L131.92.000 - pag. 318	Art. L244.04.000 - pag. 315	Art. L308.88.000CP - pag. 318	Art. L323.93.000 - pag. 312
Art. L013.08.000 - pag. 306	Art. L101.88.216 - pag. 317	Art. L131.92.000CP - pag. 318	Art. L246.93.000 - pag. 327	Art. L308.92.000 - pag. 314	Art. L324.02.000 - pag. 310
Art. L014.08.000 - pag. 306	Art. L101.92.000 - pag. 311	Art. L132.92.000 - pag. 318	Art. L248.93.000 - pag. 327	Art. L308.93.000 - pag. 313	Art. L325.02.000 - pag. 310
Art. L014.08.000CP - pag. 306	Art. L101.93.000 - pag. 324	Art. L132.92.000CP - pag. 318	Art. L249.93.000 - pag. 327	Art. L309.93.000 - pag. 325	Art. L325.93.000 - pag. 313
Art. L017.08.000 - pag. 307	Art. L102.88.216 - pag. 317	Art. L134.92.000 - pag. 318	Art. L250.93.000 - pag. 327	Art. L310.92.000 - pag. 320	Art. L325.93.000CP - pag. 313
Art. L018.08.000 - pag. 307	Art. L102.92.000 - pag. 311	Art. L136.92.000 - pag. 311	Art. L256.93.000 - pag. 328	Art. L311.02.000 - pag. 307	Art. L326.93.000 - pag. 328
Art. L019.08.000 - pag. 306	Art. L103.88.216 - pag. 317	Art. L151.94.000 - pag. 311	Art. L257.93.000 - pag. 328	Art. L311.92.000 - pag. 320	Art. L327.02.000 - pag. 307
Art. L019.08.000CP - pag. 306	Art. L103.93.000 - pag. 326	Art. L152.94.000 - pag. 311	Art. L259.88.231 - pag. 317	Art. L311.93.000 - pag. 325	Art. L327.93.000 - pag. 327
Art. L020.08.000 - pag. 307	Art. L103.93.000CP - pag. 326	Art. L201.93.000 - pag. 314	Art. L260.93.000 - pag. 328	Art. L312.02.000 - pag. 307	Art. L328.02.000 - pag. 307
Art. L031.88.119 - pag. 315	Art. L104.88.216 - pag. 317	Art. L202.88.014 - pag. 317	Art. L261.93.000 - pag. 328	Art. L312.92.015 - pag. 314	Art. L328.93.000 - pag. 328
Art. L032.88.119 - pag. 315	Art. L104.92.000 - pag. 311	Art. L203.88.014 - pag. 317	Art. L264.93.000 - pag. 327	Art. L312.93.000 - pag. 325	Art. L328.93.000CP - pag. 328
Art. L035.88.119 - pag. 315	Art. L105.92.000 - pag. 311	Art. L207.93.000 - pag. 311	Art. L281.93.000 - pag. 314	Art. L312.93.000CP - pag. 325	Art. L329.02.000 - pag. 307
Art. L036.88.119 - pag. 315	Art. L106.93.000 - pag. 324	Art. L208.93.000 - pag. 313	Art. L287.93.000 - pag. 328	Art. L313.02.000 - pag. 307	Art. L329.92.000 - pag. 320
Art. L039.88.119 - pag. 315	Art. L106.94.000 - pag. 311	Art. L210.93.000 - pag. 313	Art. L288.93.000 - pag. 319	Art. L313.92.014 - pag. 315	Art. L330.02.000 - pag. 308
Art. L040.88.119 - pag. 315	Art. L108.93.000 - pag. 324	Art. L211.93.000 - pag. 313	Art. L289.93.000 - pag. 325	Art. L313.93.000 - pag. 327	Art. L331.92.000 - pag. 320
Art. L041.88.119 - pag. 315	Art. L108.93.000CP - pag. 324	Art. L212.93.000 - pag. 313	Art. L289.93.000CP - pag. 325	Art. L314.02.000 - pag. 307	Art. L338.02.000 - pag. 308
Art. L042.88.119 - pag. 315	Art. L108.94.000 - pag. 311	Art. L217.93.000 - pag. 312	Art. L302.92.000 - pag. 314	Art. L314.92.044 - pag. 315	Art. L347.02.000 - pag. 308
Art. L050.88.013 - pag. 315	Art. L109.94.000 - pag. 311	Art. L219.93.000 - pag. 312	Art. L302.93.000 - pag. 327	Art. L315.02.000 - pag. 307	Art. L348.02.000 - pag. 308

Art. L349.02.000 - pag. 306	Art. L424.02.000CP - pag. 309	Art. L524.93.000 - pag. 314	Art. L545.92.000 - pag. 321	Art. L603.92.000 - pag. 318
Art. L350.02.000CP - pag. 306	Art. L426.02.000 - pag. 310	Art. L524.93.000CP - pag. 314	Art. L545.92.000CP - pag. 321	Art. L604.92.000 - pag. 319
Art. L351.02.000 - pag. 308	Art. L426.02.000CP - pag. 310	Art. L525.93.000 - pag. 328	Art. L546.92.000 - pag. 321	Art. L605.92.000 - pag. 322
Art. L352.02.000 - pag. 308	Art. L427.02.000 - pag. 310	Art. L525.93.000CP - pag. 328	Art. L546.92.000CP - pag. 321	Art. L606.92.000 - pag. 322
Art. L356.02.000 - pag. 308	Art. L427.02.000CP - pag. 310	Art. L526.93.000 - pag. 326	Art. L548.92.000 - pag. 321	Art. L607.92.000 - pag. 322
Art. L356.04.000 - pag. 315	Art. L442.93.000DIY - pag. 328	Art. L527.92.000 - pag. 320	Art. L549.92.000 - pag. 324	Art. L608.92.000 - pag. 322
Art. L358.02.000 - pag. 308	Art. L446.04.000 - pag. 307	Art. L527.93.000 - pag. 326	Art. L551.92.000 - pag. 321	Art. L609.92.000 - pag. 322
Art. L359.02.000 - pag. 308	Art. L451.93.000DIY - pag. 329	Art. L528.92.000 - pag. 320	Art. L552.92.000 - pag. 321	Art. L610.92.000 - pag. 322
Art. L362.02.000 - pag. 308	Art. L452.93.000DIY - pag. 329	Art. L528.93.000 - pag. 326	Art. L552.92.000CP - pag. 321	Art. L613.92.000 - pag. 322
Art. L363.02.000 - pag. 308	Art. L453.93.000DIY - pag. 329	Art. L529.92.000 - pag. 320	Art. L553.92.000 - pag. 321	Art. L614.92.000 - pag. 323
Art. L368.93.000 - pag. 313	Art. L454.93.000DIY - pag. 329	Art. L529.93.000 - pag. 326	Art. L553.92.000CP - pag. 321	Art. L615.92.000 - pag. 319
Art. L369.04.000 - pag. 318	Art. L456.02.000 - pag. 306	Art. L529.93.000CP - pag. 326	Art. L561.92.000 - pag. 322	Art. L615.92.000CP - pag. 319
Art. L392.02.000 - pag. 308	Art. L457.93.000DIY - pag. 329	Art. L530.92.000 - pag. 320	Art. L561.92.000CP - pag. 321	Art. L617.92.000 - pag. 319
Art. L392.02.000CP - pag. 308	Art. L463.93.000DIY - pag. 314	Art. L530.93.000 - pag. 326	Art. L562.92.000 - pag. 322	Art. L618.92.000 - pag. 319
Art. L393.02.000 - pag. 309	Art. L473.93.000DIY - pag. 329	Art. L530.93.000CP - pag. 326	Art. L563.92.000 - pag. 322	Art. L621.92.000 - pag. 323
Art. L393.02.000CP - pag. 308	Art. L474.93.000DIY - pag. 327	Art. L531.92.000 - pag. 320	Art. L565.92.000 - pag. 322	Art. L622.92.000 - pag. 323
Art. L394.02.000 - pag. 309	Art. L476.93.000DIY - pag. 329	Art. L531.92.000CP - pag. 320	Art. L566.92.000 - pag. 322	Art. L623.92.000 - pag. 319
Art. L394.02.000CP - pag. 309	Art. L477.93.000DIY - pag. 329	Art. L531.93.000 - pag. 326	Art. L581.92.000 - pag. 323	Art. L624.92.000 - pag. 323
Art. L395.02.000 - pag. 309	Art. L478.93.000DIY - pag. 327	Art. L531.93.000CP - pag. 326	Art. L582.92.000 - pag. 323	Art. L629.92.000 - pag. 319
Art. L395.02.000CP - pag. 309	Art. L481.93.000DIY - pag. 327	Art. L532.92.000 - pag. 320	Art. L583.92.000 - pag. 323	Art. L639.02.000 - pag. 306
Art. L396.02.000 - pag. 309	Art. L490.93.000DIY - pag. 329	Art. L532.92.000CP - pag. 320	Art. L584.92.000 - pag. 323	Art. L639.02.000CP - pag. 306
Art. L396.02.000CP - pag. 309	Art. L511.92.000 - pag. 318	Art. L533.92.000 - pag. 320	Art. L585.92.000 - pag. 323	Art. L657.02.000 - pag. 310
Art. L398.02.000 - pag. 309	Art. L512.92.000 - pag. 318	Art. L533.92.000CP - pag. 320	Art. L586.92.000 - pag. 323	Art. L658.02.000 - pag. 310
Art. L398.02.000CP - pag. 309	Art. L517.92.000 - pag. 318	Art. L534.92.000 - pag. 321	Art. L587.92.000 - pag. 323	Art. L675.92.000 - pag. 319
Art. L399.02.000 - pag. 309	Art. L518.92.000 - pag. 318	Art. L535.92.000 - pag. 321	Art. L588.92.000 - pag. 323	Art. L675.92.000CP - pag. 319
Art. L399.02.000CP - pag. 309	Art. L521.93.000 - pag. 326	Art. L536.92.000 - pag. 324	Art. L589.92.000 - pag. 323	Art. L696.02.000 - pag. 310
Art. L399.93.000 - pag. 314	Art. L521.93.000CP - pag. 326	Art. L537.92.000 - pag. 321	Art. L590.92.000 - pag. 324	Art. L697.02.000 - pag. 310
Art. L401.93.000 - pag. 314	Art. L522.93.000 - pag. 313	Art. L538.92.000 - pag. 319	Art. L591.92.000 - pag. 324	Art. L701.92.000 - pag. 319
Art. L410.02.000 - pag. 309	Art. L522.93.000CP - pag. 313	Art. L539.92.000 - pag. 319	Art. L592.92.000 - pag. 324	Art. L702.92.000 - pag. 319
Art. L412.93.000 - pag. 328	Art. L523.93.000 - pag. 313	Art. L540.92.000 - pag. 324	Art. L601.92.000 - pag. 322	Art. L703.92.000 - pag. 323
Art. L424.02.000 - pag. 309	Art. L523.93.000CP - pag. 313	Art. L543.92.000 - pag. 324	Art. L602.92.000 - pag. 322	Art. RT1 - pag. 265





Ar-Fer arte ferro srl

Ai sensi e per gli effetti dell'art. 41 del codice di proprietà industriale è vietata l'utilizzazione, la fabbricazione, l'offerta, la commercializzazione, l'importazione, l'esportazione o l'impiego di un prodotto in cui i disegni o i modelli registrati da Ar-fer arte ferro srl e riprodotti nel presente catalogo siano applicati senza il suo preventivo consenso.

La società Ar-fer arte ferro srl si riserva di effettuare costantemente dei controlli su tutto il territorio mediante personale autorizzato o agenti di zona al fine di verificare l'uso non consentito dei modelli depositati.

È assolutamente vietata la riproduzione anche parziale del presente catalogo, di cui Ar-fer arte ferro srl possiede i diritti di copyright.



OPERE IN FERRO ITALIANE



Ar-Fer arte ferro srl

Via dell'Artigianato, 9
31040 CUSIGNANA DI GIAVERA del Montello (TV) ITALY
Tel. + 39 0422 870370
Fax + 39 0422 870333
www.arfer.it - arfer@arfer.it