

# EUROFER®

LAVORAZIONE DEL FERRO BATTUTO & ACCIAIO INOX  
WROUGHT IRON & STAINLESS STEEL WORKING



1967 55

# OFFO

LA PRODUZIONE COMPLETA  
THE WHOLE PRODUCTION









**LA PRODUZIONE COMPLETA  
DI ELEMENTI IN FERRO BATTUTO**

**THE WHOLE PRODUCTION  
OF WROUGHT IRON COMPONENTS**

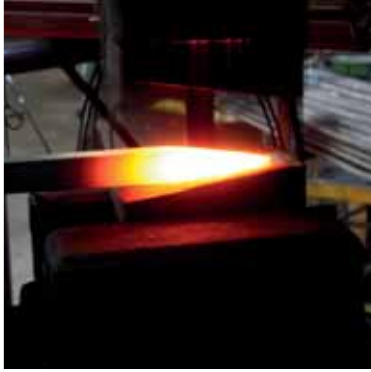
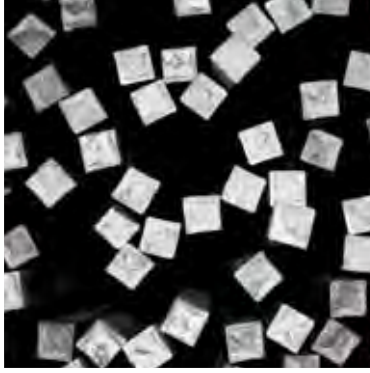
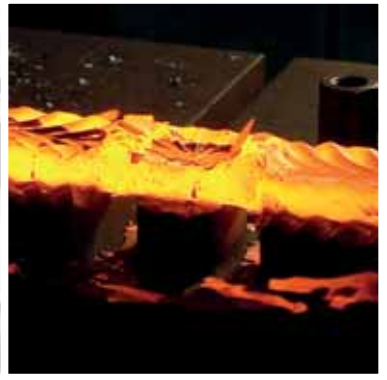
**LA PRODUCTION COMPLETE  
D'ELEMENTS EN FER FORGÉ**



# INDICE / INDEX / INDEX

	CONDIZIONI DI VENDITA / <i>GENERAL CONDITIONS</i>	PAG	4
	LEGENDA / <i>LEGENDA</i>		5
	TERMINALI / <i>ENDS / FINITIONS</i>		6
<b>01</b>	RICCI <i>SCROLLS / VOLUTES</i>		7
<b>02</b>	CERCHI, OVALI E PIGNE <i>CIRCLES, OVALS AND BASKETS / CERCLES, OVALES ET PIGNES TORSADÉES</i>		34
<b>03</b>	ROSONI E QUADRILOBI <i>ROSETTES AND CLIP-ON-UNITS / ROSACES ET ELEMENTS DÉCORATIFS</i>		42
<b>04</b>	BARRE SAGOMATE - LINEA LIBERTY <i>SHAPED BARS - LIBERTY LINE / BARREAUX GALBÉS - PANNEAUX DÉCO</i>		60
<b>05</b>	PANNELLI LISCI E PALETTI PER RECINZIONI <i>PLAIN PANEL UNITS AND STAKES FOR FENCES BARREAUX DE BALCON ET DE CLÔTURE</i>		75
<b>06</b>	PANNELLI MARTELLATI <i>HAMMERED PANELS / PANNEAUX MARTELÉS</i>		113
<b>07</b>	PANNELLI LIQUIRIZIA - PANNELLI RIGATI <i>LIQUORICE PANELS - FLUTED PANELS PANNEAUX RÉGLISSE ET RAYÉS</i>		118
<b>08</b>	BARRE FORATE <i>HOLED BARS / BARRES À TROUS</i>		122
<b>09</b>	TENDENZE ODIERNE <i>MODERN DESIGNS / BARREAUX DÉCORATIFS</i>		136
<b>10</b>	ELEMENTI IN FERRO RICALCATO <i>NEW FORGED BARS / ÉLÉMENTS MODERNES</i>		156
<b>11</b>	ELEMENTI IN FERRO FORGIATO, CAPISALDI E FORGIATI ITALIANI <i>FORGED BARS, POSTS AND  FORGED BARS PANNEAUX FORGÉS, POTEAUX ET FER FORGÉ </i>		164
<b>12</b>	CORRIMANO E PARTENZE <i>HANDRAILS AND CORNERS / MAIN COURANTES, CROSSES DE DÉPART</i>		182
<b>13</b>	BORCHIE, LANCE E PIASTRE <i>STUDS, SPEARS AND PLATES / FERS DE LANCE, BAGUES, PLATINES ACIER</i>		202
<b>14</b>	FIORI E FOGLIE <i>FLOWERS AND LEAVES / FLEURS ET FEUILLES</i>		220
<b>15</b>	CIMASE, TERMINALI ED ELEMENTI VARI <i>ORNAMENTS FOR CARRIAGE GATES AND VARIOUS ELEMENTS ELEMENTS POUR PORTAILS, CLÉS DE TIRANTS ET DIVERS ÉLÉMENTS</i>		229
<b>16</b>	COMPONENTI VARI PER ARREDAMENTO <i>VARIOUS DECOR ELEMENTS / POIGNÉES ET DIVERS ÉLÉMENTS DE DÉCORATION</i>		244
<b>CI</b>	COMPONENTI IN GHISA <i>ELEMENTS IN CAST IRON / FONTE</i>		256
<b>ZF</b>	ARTICOLI ZINCATI A FREDDO <i>COLD GALVANIZED ARTICLES / ÉLÉMENTS GALVANISÉS</i>		257
	Riassunto barre forate in ordine di codice <i>Summary holed bars in order of code / Barre à trous par ordre de référence</i>		261
<b>L</b>	LASERFER		268



# CONDIZIONI GENERALI / GENERAL CONDITIONS

## 1. Offerte e Ordini

1.1 I tempi di consegna riportati nelle Offerte e nelle Conferme d'Ordine sono puramente indicativi e quindi non vincolanti.

1.2 In nessun caso Euro-Fer Spa potrà essere chiamata a risponderne dei danni direttamente o indirettamente causati dalla ritardata esecuzione di un contratto o dalla ritardata consegna dei prodotti.

1.3 Gli ordini e/o le modifiche di ordini effettuate verbalmente devono essere confermati per iscritto da parte dell'acquirente. In caso contrario Euro-Fer Spa non si assume alcuna responsabilità con riguardo a eventuali errori o possibili fraintendimenti.

1.4 Euro-Fer Spa si riserva la possibilità di frazionare un ordine in più spedizioni.

1.5 I prezzi non sono comprensivi di IVA.

## 2. Restituzione merci

2.1 Euro-Fer Spa non è obbligata ad accettare resi dei prodotti, salvo che sia stato espressamente pattuito per iscritto. Qualsiasi costo a tal fine è sostenuto dall'Acquirente.

2.2 In tutti i casi Euro-Fer Spa non accetta resi di materiale manomesso o modificato rispetto alla fornitura iniziale.

## 3. Reclami

3.1 Al momento della presa in consegna dei prodotti l'Acquirente dovrà immediatamente verificare la quantità, l'imballaggio e la conformità, e registrare qualsiasi obiezione nella nota di consegna.

3.2 Ogni denuncia per vizi, dovrà essere effettuata tramite comunicazione scritta entro 8 giorni dall'arrivo della merce.

3.3 La comunicazione di cui al 3.2 dovrà chiaramente identificare la fornitura originale e specificare tipologia e ammontare dei vizi addotti.

## 4. Varie

4.1 Le misure e le fotografie espresse nel catalogo sono indicative, pertanto i prodotti venduti possono differire leggermente.

4.2 Euro-Fer Spa non accetterà reclami per inconvenienti o anomalie dovuti a applicazioni post-vendita non corrette o non adeguate al prodotto. Trattamenti quali verniciatura, zincatura elettrolitica, zincatura a caldo, sabbiatura, o altri, realizzati dopo la vendita, saranno eseguiti sollevando Euro-fer Spa da qualsiasi responsabilità.

4.3 La riproduzione, anche parziale, del presente catalogo è vietata. Tutti i diritti sono riservati da Euro-Fer Spa.

4.4 I documenti, disegni, dati ed informazioni che dovessero venire consegnati al Cliente, rimangono di esclusiva proprietà di Euro-Fer Spa. Il Cliente si impegna a non riprodurli, a non divulgarli a terzi e ad assumere altresì le opportune cautele nei confronti del proprio personale al fine di garantirne la tutela.

4.5 La gamma di Euro-Fer Spa è composta da articoli di differenti materiali: ferro, acciaio, ottone, ghisa, plastica, cristallo, vetro, etc, ciascuno con le proprie caratteristiche e adatto a particolari utilizzi. E' esclusiva responsabilità del Cliente scegliere i prodotti più indicati alle proprie esigenze ornamentali e di utilizzo.

## 1. Offers and Orders

1.1 *The delivery terms specified in the Offer and in the Order Confirmation are purely indicative and not binding.*

1.2 *In no case will Euro-Fer Spa be liable for damages directly or indirectly caused by the delayed execution of a contract or the delayed delivery of the products.*

1.3 *Purchase orders and / or changes to purchase orders made verbally must be confirmed in writing by the Buyer. Otherwise, Euro-Fer Spa assumes no responsibility for any errors or misunderstandings.*

1.4 *Euro-Fer Spa reserves the right to split a purchase order in several consignments.*

1.5 *Prices do not include VAT.*

## 2. Return policy

2.1 *Euro-Fer Spa is not obliged to accept returns of products, unless expressly agreed in writing. Any cost arising from the return shall be borne by the Buyer.*

2.2 *In all cases Euro-Fer Spa does not accept returns of material tampered with or modified with respect to what was initially supplied.*

## 3. Claims

3.1 *Upon receipt of the products, the Buyer shall immediately check the quantity, packaging and conformity, and record any objections in the delivery note.*

3.2 *Any complaint for defects must be made by written communication within 8 days of receipt of the goods.*

3.3 *The written communication relating to paragraph 3.2 must clearly identify the original supply and specify the type and number of defects alleged.*

## 4. Others

4.1 *Sizes and pictures shown in the catalogues are indicative, therefore the products may differ slightly.*

4.2 *Euro-Fer Spa will not accept claims for inconveniences or anomalies due to incorrect or inappropriate after-sales applications of its products. Treatments such as painting, electrolytic zinc-plating, hot dip galvanizing, sandblasting, or others, made after the sale, will be carried out by relieving Euro-fer Spa from any responsibility.*

4.3 *The reproduction, even partial, of this catalogue is strictly forbidden. All rights are reserved by Euro-Fer Spa.*

4.4 *The documents, drawings, data and information provided from Euro-fer Spa to the Buyer, remain exclusive property of Euro-Fer Spa. The Buyer undertakes not to reproduce them, not to disclose them to third parties and at the same time to take the appropriate precautions toward their staff in order to guarantee its protection.*

4.5 *Euro-Fer Spa range consists of items made of different materials: iron, steel, brass, cast iron, plastic, crystal, glass, etc., each with its own characteristics and suitable for specific uses. It is sole responsibility of the Buyer to choose the most suitable products for its ornamental and use needs.*

# LEGENDA / LEGENDA

Le misure sono espresse in millimetri. La lettera "H" sta per altezza e "L" per larghezza, mentre le sezioni sono indicate con i simboli:  $\neq \emptyset$  □ (piatto, tondo o diametro, quadro). Tra le dimensioni indicate e quelle reali vi possono essere delle lievi differenze, proprio perchè ogni elemento è prodotto in gran parte a mano.

(ca.) - Per le caratteristiche particolari del ferro forgiato, le misure degli articoli che seguono possono subire delle lievi variazioni dovute al tipo di lavorazioni cui sono sottoposti.

EURO-FER si riserva di apportare qualsiasi variazione ai dati indicati, al fine di migliorare il prodotto.

A richiesta è possibile realizzare produzioni personalizzate con motivi e misure non presenti in questo catalogo. Le personalizzazioni sono possibili solo per determinate quantità.

All dimensions are expressed in millimeters. The letter "H" stands for height; "L" stands for length, while the shapes of the sections are indicated with the symbols:  $\neq \emptyset$  □ (flat, round or diameter, square). There may be slight differences between the dimensions indicated and the real dimensions, precisely because each creation is produced in large part by the craftsman's hand.

(ca.) - Because of their peculiarity, the measures of forged bars could be subjected to small variations due to their particular working process.

EURO-FER retains the right to change the specification indicated in order to improve the product.

Personalized creations with patterns and sizes not illustrated in this catalogues can be ordered on request. Personalized work can be performed only for certain quantities.

- .AL** Articolo realizzato in alluminio  
*Item made of Aluminum*
- .B** Borchia svasata  
*Iron bush with countersunk hole*
- .CI** Articolo in ghisa  
*Item made of Cast Iron*
- .CS** Articolo in Fusione  
*Item made of Cast Steel*
- .CO** Superficie tipo 'Corteccia'  
*"Bark" type surface*
- .D** Misura intermedia tra l'articolo standard e la versione .E  
*Intermediate size between the standard item and the .E version (lightened or smaller)*
- .E** modello come l'articolo di riferimenti ma 'alleggerito' e quindi più economico  
*Item similar to article of reference (same item number) but 'lightened' or smaller and therefore cheaper*
- .ES** modello España  
*Identifies the 'España' models, popular in particular markets*
- .R** Borchia Rullata  
*Iron bush with rolled surface*
- .RM** Rigato e Martellato  
*Fluted and hammered profile*
- .S** Smussato  
*Edged corners profile*
- .ZC** \*Zincato a Caldo  
*\*Hot-dip galvanized item*
- .ZF** \*Zincato a Freddo  
*\*Cold galvanized item*

**Liquirizia** Modello Rigato, Martellato e Attorcigliato  
**Liquorice** *Fluted, hammered and twisted profile*  
Linea Liberty, articoli che possono includere particolari in ghisa o in ferro fuso.  
*The Liberty Line identifies items that can include parts made of cast iron or cast steel.*



Modello depositato  
*Patent pending*

Fiori da entrambi i lati  
*Flowers on both sides*

\* Ricordiamo che il trattamento di zincatura (a caldo o a freddo) serve a proteggere gli articoli in ferro dalla corrosione, non è un trattamento di finitura estetica.

Euro-Fer Spa non accetta reclami dovuti all'aspetto della zincatura (opaca o lucida, chiara o scura, presenza di cenere o gocce dal bagno di zinco, etc.).

\*We remind you that the galvanizing treatment (hot or cold) is used to protect iron products from corrosion, it is not an aesthetic finishing treatment.

Euro-Fer Spa doesn't accept complaints regarding the shape of the galvanizing (shiny or matt, light or dark, ashes or drops from the zinc bath, etc.).

Nuovo articolo  
New item

NEW

# TERMINALI / ENDS / FINITIONS

———— a freddo / cold cut / à froid ————



tranciato dritto  
*straight cut*  
*coupe droite*

**TD**



tranciato punta  
*pointed cut*  
*coupe pointu*

**TP**



tranciato arrotondato  
*rounded cut*  
*coupe ronde*

**PA**



rastremato liscio  
*smooth tapered*  
*effilé lisse*

**RL**



rastremato rigato  
*tapered and fluted*  
*effilé rayé*

**RR**



a "spina di pesce"  
*"fish bone"*  
*à chevrons*

**SP**



pallina piccola  
*small ball*  
*petite boule*

**PP**



pallina grande  
*large ball*  
*grosse boule*

**PG**



pallina "a sole"  
*sun ball*  
*boule "soleil"*

**PS**

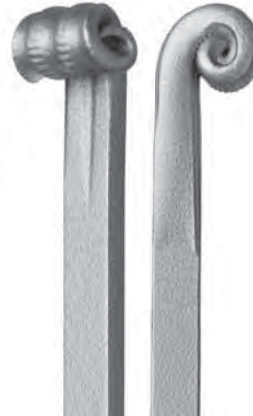

chiocciola rigata  
*fluted spiral*  
*escargot rayé*

**CR**

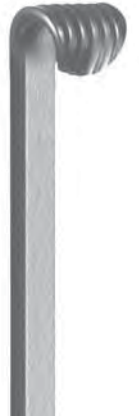

uncino rigato  
*fluted hook*  
*crochet rayé*

**UR**

———— a freddo / cold cut / à froid ————



chiocciola schiacciata  
*pressed spiral*  
*escargot écrasé*

**CS**



nocciolina a caldo  
*peanut (heat forging)*  
*cacahuète à chaud*

**NC**



schiacciata a freddo liscia  
*cold-pressed*  
*écrasée à froid*

**SF**



schiacciata a freddo rigata  
*cold fluted pressed*  
*écrasée et rayée à froid*

**SR**



TP



H.117 X L.60 mm.

- Art. 01.001 □ 8 X 8
- Art. 01.002 ≙ 16 X 4
- Art. 01.003 ≙ 10 X 5
- Art. 01.004 ≙ 12 X 6
- Art. 01.005 ≙ 20 X 6
- Art. 01.005.01 ≙ 14 X 6
- Art. 01.005.02 ≙ 20 X 4

TP



H.125 X L.75 mm.

- Art. 01.005.11 ≙ 20 X 6
- Art. 01.005.12 ≙ 14 X 6
- Art. 01.005.14 ≙ 16 X 6

TP



H.135 X L.75 mm.

- Art. 01.006 □ 8 X 8
- Art. 01.007 ≙ 16 X 4
- Art. 01.008 ≙ 10 X 5
- Art. 01.009 ≙ 12 X 6
- Art. 01.010 ≙ 20 X 6
- Art. 01.010.01 ≙ 14 X 6
- Art. 01.010.02 ≙ 20 X 4

TP



H.180 X L.105 mm.

- Art. 01.010.12 ≙ 14 X 6
- Art. 01.010.14 ≙ 16 X 6

TP

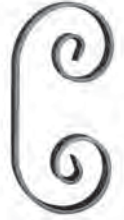

H.180 X L.85 mm.

- Art. 01.011 □ 8 X 8
- Art. 01.012 ≙ 16 X 4
- Art. 01.013 ≙ 10 X 5
- Art. 01.014 ≙ 12 X 6
- Art. 01.015 ≙ 20 X 6
- Art. 01.015.01 ≙ 14 X 6
- Art. 01.015.02 ≙ 20 X 4

RL



RL



TP



H.220 X L.100 mm.

- Art. 01.015.10 ≙ 12 X 6

TP



H.220 X L.90 mm.

- Art. 01.016 □ 8 X 8
- Art. 01.017 ≙ 16 X 4
- Art. 01.018 ≙ 12 X 6
- Art. 01.018.01 ≙ 14 X 6

TP



H.210 X L.100 mm.

- Art. 01.018.08 ≙ 16 X 4
- Art. 01.018.10 ≙ 12 X 6

TP



H.220 X L.110 mm.

- Art. 01.019 □ 8 X 8
- Art. 01.020 ≙ 16 X 4
- Art. 01.021 ≙ 10 X 5
- Art. 01.022 ≙ 12 X 6
- Art. 01.023 ≙ 14 X 6
- Art. 01.024 ≙ 20 X 6
- Art. 01.024.01 ≙ 20 X 4

TP



H.290 X L.120 mm.

- Art. 01.025 □ 8 X 8
- Art. 01.026 ≙ 16 X 4
- Art. 01.027 ≙ 10 X 5
- Art. 01.028 ≙ 12 X 6
- Art. 01.029 ≙ 14 X 6
- Art. 01.030 ≙ 20 X 6
- Art. 01.030.01 ≙ 20 X 4

TP



H.325 X L.115 mm.

- Art. 01.030.10 ≙ 16 X 6

TP



H.360 X L.125 mm.

- Art. 01.031 □ 8 X 8
- Art. 01.032 ≙ 16 X 4
- Art. 01.033 ≙ 10 X 5
- Art. 01.034 ≙ 12 X 6
- Art. 01.035 ≙ 14 X 6
- Art. 01.036 ≙ 20 X 6
- Art. 01.036.01 ≙ 20 X 4

TP



H.350 X L.100 mm.

- Art. 01.037 □ 8 X 8
- Art. 01.038 ≙ 16 X 4
- Art. 01.039 ≙ 10 X 5
- Art. 01.040 ≙ 12 X 6
- Art. 01.040.01 ≙ 14 X 6

TP



H.290 X L.100 mm.

- Art. 01.040.08 ≙ 16 X 4
- Art. 01.040.10 ≙ 12 X 6

TP



H.290 X L.120 mm.

- Art. 01.041 ≙ 16 X 4
- Art. 01.042 ≙ 12 X 6
- Art. 01.043 ≙ 14 X 6
- Art. 01.044 ≙ 20 X 6
- Art. 01.044.01 ≙ 20 X 4

TP



H.360 X L.125 mm.

- Art. 01.045 ≙ 16 X 4
- Art. 01.046 ≙ 12 X 6
- Art. 01.047 ≙ 14 X 6
- Art. 01.048 ≙ 20 X 6
- Art. 01.048.01 ≙ 20 X 4

TP



H.290 X L.125 mm.

- Art. 01.049 ≙ 16 X 4

TP



H.450 X L.95 mm.

- Art. 01.050 ≙ 16 X 4

TP



H.450 X L.125 mm.

- Art. 01.051 ≙ 16 X 4
- Art. 01.052 ≙ 20 X 6

TP



H.150 X L.105 mm.

- Art. 01.052.06 ≙ 14 X 6
- Art. 01.052.10 ≙ 16 X 6

TP

tranciato punta a freddo  
cold pointed cut



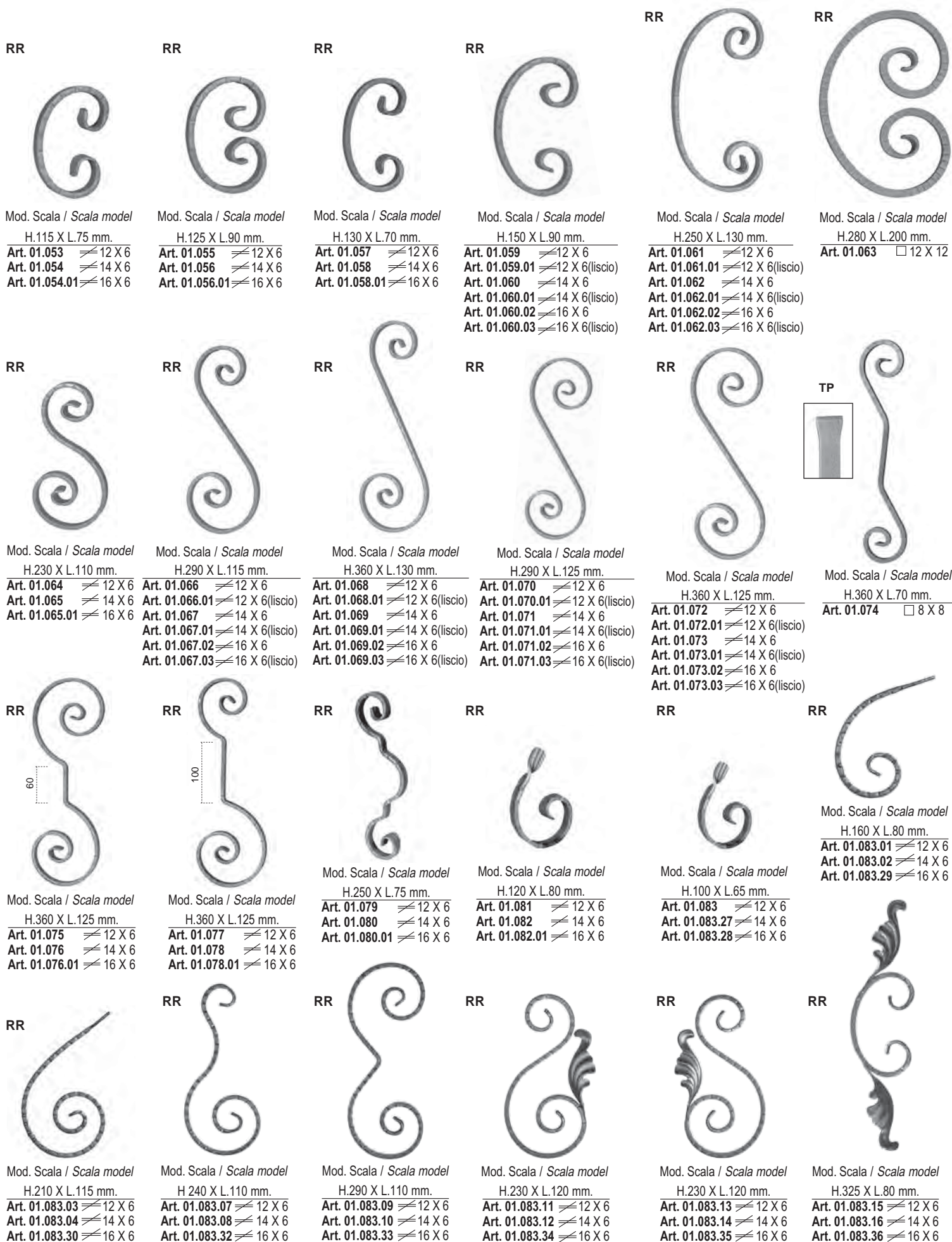



RR  
Mod. Scala / Scala model  
H.145 X L.75 mm.  
Art. 01.083.17 ≙ 12 X 6  
Art. 01.083.18 ≙ 14 X 6  
Art. 01.083.37 ≙ 16 X 6



RR  
Mod. Scala / Scala model  
H.110 X L.60 mm.  
Art. 01.083.19 ≙ 12 X 6  
Art. 01.083.20 ≙ 14 X 6  
Art. 01.083.38 ≙ 16 X 6



RR  
Mod. Scala / Scala model  
H.200 X L.100 mm.  
Art. 01.083.21 ≙ 14 X 6  
Art. 01.083.39 ≙ 16 X 6



RR  
Mod. Scala / Scala model  
H.220 X L.110 mm.  
Art. 01.083.22 ≙ 14 X 6  
Art. 01.083.41 ≙ 16 X 6



RR  
Mod. Scala / Scala model  
H.380 X L.180 mm.  
Art. 01.083.23 ≙ 12 X 6  
Art. 01.083.24 ≙ 14 X 6  
Art. 01.083.43 ≙ 16 X 6



RR  
Mod. Scala / Scala model  
H.310 X L.35 mm.  
Art. 01.083.25 ≙ 14 X 6  
Art. 01.083.44 ≙ 16 X 6



RR  
Mod. Scala / Scala model  
H.420 X L.35 mm.  
Art. 01.083.26 ≙ 14 X 6



RR  
Liscio / Smooth  
H.220 X L.110 mm.  
Art. 01.086.01 ≙ 12 X 6  
Art. 01.086.11 ≙ 16 X 8

Mod. Scala / Scala model  
H.220 X L.110 mm.  
Art. 01.086.02 ≙ 12 X 6

Martellato / Hammered  
H.220 x L.110 mm  
Art. 01.086.51 ≙ 12 x 6



RR  
Liscio / Smooth  
H.200 X L.100 mm.  
Art. 01.086.03 ≙ 12 X 6  
Art. 01.086.13 ≙ 16 X 8

Mod. Scala / Scala model  
H.200 X L.100 mm.  
Art. 01.086.04 ≙ 12 X 6  
Art. 01.086.14 ≙ 16 X 8

Martellato / Hammered  
H.200 x L.100 mm  
Art. 01.086.50 ≙ 12 x 6

RR  
rastremato rigato a caldo  
hot tapered and fluted



H.140 X L.75 mm.  
Art. 01.086.70 ≙ 12 X 4  
Art. 01.086.71 ≙ 14 X 4  
Art. 01.086.72 ≙ 16 X 4



SF  
H.115 X L.80 mm.  
Art. 01.084 ≙ 8 X 8



SF  
H.115 X L.80 mm.  
Art. 01.084.01 Ø 8



SF  
Mod. Scala / Scala model  
H.120 X L.75 mm.  
Art. 01.085 ≙ 8 X 8



RL  
Mod. Scala / Scala model  
H.120 X L.75 mm.  
Art. 01.086 ≙ 8 X 8



RR  
Martellato / Hammered  
H.115 x L.75 mm  
Art. 01.086.20 ≙ 12 x 6

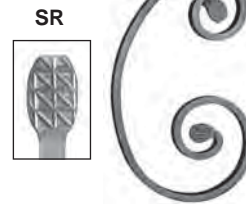

SR  
H.180 X L.110 mm.  
Art. 01.087 ≙ 12 X 6

Tutte le parti di questo catalogo - foto comprese - sono di proprietà Euro-Fer. La riproduzione, anche parziale, è vietata in ogni forma e con ogni mezzo. / Every part of this catalogue - photos included - is Euro-Fer's property. All forms of copying are strictly prohibited.



**SP**  
ricci e terminali  
"a spina di pesce"  
"fish bone"  
scrolls and end



SP



H.100 X L.60 mm.  
Art. 01.086.05 ≙ 12 X 6  
Art. 01.086.06 ≙ 14 X 6  
Art. 01.086.15 ≙ 16 X 6  
Art. 01.086.18 ≙ 20 X 6

SP



H.125 X L.75 mm.  
Art. 01.086.07 ≙ 12 X 6  
Art. 01.086.08 ≙ 14 X 6  
Art. 01.086.16 ≙ 16 X 6  
Art. 01.086.19 ≙ 20 X 6

SP



H.150 X L.80 mm.  
Art. 01.086.09 ≙ 12 X 6  
Art. 01.086.10 ≙ 14 X 6  
Art. 01.086.17 ≙ 16 X 6  
Art. 01.086.21 ≙ 20 X 6

SP



H.180 X L.105 mm.  
Art. 01.086.24 ≙ 14 X 6  
Art. 01.086.25 ≙ 16 X 6  
Art. 01.086.26 ≙ 20 X 6

SP



H.200 X L.125 mm.  
Art. 01.086.30 ≙ 14 X 6  
Art. 01.086.31 ≙ 16 X 6

SP



H.100 X L.65 mm.  
Art. 01.086.35 ≙ 14 X 6  
Art. 01.086.36 ≙ 16 X 6  
Art. 01.086.37 ≙ 20 X 6

SP



H.110 X L.90 mm.  
Art. 01.086.40 ≙ 14 X 6  
Art. 01.086.41 ≙ 16 X 6  
Art. 01.086.42 ≙ 20 X 6

SP



H.150 X L.105 mm.  
Art. 01.086.45 ≙ 14 X 6  
Art. 01.086.46 ≙ 16 X 6  
Art. 01.086.47 ≙ 20 X 6

SP



H.180 X L.125 mm.  
Art. 01.086.60 ≙ 14 X 6  
Art. 01.086.61 ≙ 16 X 6  
Art. 01.086.52 ≙ 20 X 6

SP



H.110 X L.65 mm.  
Art. 01.086.62 ≙ 12 X 6  
Art. 01.086.63 ≙ 14 X 6  
Art. 01.086.64 ≙ 16 X 6

NEW

SP

NEW



H.350 X L.110 mm.  
Art. 01.086.80 ≙ 12 X 6  
Art. 01.086.81 ≙ 14 X 6  
Art. 01.086.82 ≙ 16 X 6

SP

NEW



H.270 X L.110 mm.  
Art. 01.086.83 ≙ 12 X 6  
Art. 01.086.84 ≙ 14 X 6  
Art. 01.086.85 ≙ 16 X 6

SF



H.180 X L.95 mm.  
Art. 01.087.01 □ 10 X 10  
Art. 01.087.02 ∅ 8

SF



H.180 X L.95 mm.  
Art. 01.088 □ 8 X 8

RR



Mod. Scala / Scala model  
H.240 X L.50 mm.  
Art. 01.088.01 ≙ 12 X 6  
Art. 01.088.02 ≙ 14 X 6

SF



H.250 X L.100 mm.  
Art. 01.088.03 □ 8 X 8  
Art. 01.088.04 □ 10 X 10  
Art. 01.088.05 ∅ 8

SF



H.140 X L.60 mm.  
Art. 01.088.06 ∅ 8

SF



H.220 X L.110 mm.  
Art. 01.089 □ 8 X 8

SF



H.220 X L.110 mm.  
Art. 01.089.01 □ 10 X 10  
Art. 01.089.02 ∅ 8

SF



H.170 X L.77 mm.  
Art. 01.089.03 ∅ 8

SF



H.290 X L.110 mm.  
Art. 01.090 □ 8 X 8

SF



























H.290 X L.110 mm.  
Art. 01.090.01 □ 10 X 10  
Art. 01.090.02 ∅ 8

Attenzione cambio codice / Notice new code

SF	SF	RR	RR	RR	RR	RR	RR
H.340 x L.90 mm	H.360 X L.110 mm.	H100 X L.75 mm.	H.125 X L.70 mm.	Martellato / Hammered H.145 X L.75 mm.	H.175 X L.105 mm.	H.280 X L.110 mm.	
Art. 01.090.05 ≙ 8 X 8	Art. 01.091 ≙ 8 X 8	Art. 01.091.03 ≙ 12 X 6	Art. 01.091.04 ≙ 14 X 6	Art. 01.091.05 ≙ 16 X 6	Art. 01.091.06 ≙ 12 X 6	Art. 01.091.07 ≙ 12 X 6	Art. 01.091.08 ≙ 14 X 6
Art. 01.090.06 ≙ 10 X 10	Art. 01.091.01 ≙ 10 X 10	Art. 01.091.19 ≙ 16 X 6			Art. 01.091.09 ≙ 12 X 6	Art. 01.091.10 ≙ 14 X 6	
	Art. 01.091.02 Ø 8						
RR	RR	RR	TP	RR	RR	RR	RR
H.190 X L.75 mm.	H.230 X L.110 mm.	H.360 X L.110 mm.	H.430 X L.128 mm.	H.200 X L.100 mm.	H.220 X L.110 mm.		
Art. 01.091.11 ≙ 12 X 6	Art. 01.091.12 ≙ 16 X 6	Art. 01.091.13 ≙ 20 X 6	Art. 01.091.14 ≙ 10 X 10	Art. 01.091.15 ≙ 12 X 6	Art. 01.091.16 ≙ 16 X 8	Art. 01.091.17 ≙ 14 X 6	Art. 01.091.18 ≙ 14 X 6
Art. 01.091.11 ≙ 12 X 6	Art. 01.091.12 ≙ 16 X 6	Art. 01.091.13 ≙ 20 X 6		Art. 01.091.17 ≙ 14 X 6	Art. 01.091.21 ≙ 16 X 6		
RR	RR	RR	RR	RR	RR	RR	RR
H.95 X L.60 mm.	H.105 X L.70 mm.	H.115 X L.75 mm.	H.110 X L.70 mm.	H.120 X L.70 mm.	H.125 X L.70 mm.	H.130 X L.70 mm.	
Art. 01.092 ≙ 12 X 6	Art. 01.093 ≙ 12 X 6	Art. 01.094 ≙ 12 X 6	Art. 01.094.01 ≙ 14 X 6	Art. 01.094.02 ≙ 12 X 6	Art. 01.095 ≙ 12 X 6	Art. 01.095.01 ≙ 14 X 6	Art. 01.096 ≙ 12 X 6
Art. 01.092.01 ≙ 14 X 6	Art. 01.093.01 ≙ 14 X 6	Art. 01.094.03 ≙ 14 X 6	Art. 01.094.04 ≙ 16 X 6	Art. 01.094.05 ≙ 16 X 6	Art. 01.095.02 ≙ 16 X 6	Art. 01.096.01 ≙ 14 X 6	Art. 01.096.02 ≙ 16 X 6
Art. 01.092.02 ≙ 16 X 6	Art. 01.093.02 ≙ 16 X 6				Art. 01.095.10 ≙ 12 X 6		
RR	RR	RR	RR	RR	RR	RR	RR
H.150 X L.75 mm.	H.140 X L.95 mm.	H.135 X L.75 mm.	H.120 X L.60 mm.	H.150 X L.70 mm.	H.230 X L.115 mm.		
Art. 01.097 ≙ 12 X 6	Art. 01.098 ≙ 12 X 6	Art. 01.098.03 ≙ 12 X 6	Art. 01.098.04 ≙ 14 X 6	Art. 01.099 ≙ 12 X 6	Art. 01.100 ≙ 12 X 6		
Art. 01.097.01 ≙ 14 X 6	Art. 01.098.01 ≙ 14 X 6	Art. 01.098.05 ≙ 16 X 6	Art. 01.098.02 ≙ 16 X 6	Art. 01.099.01 ≙ 14 X 6	Art. 01.100.01 ≙ 14 X 6		
Art. 01.097.02 ≙ 16 X 6	Art. 01.098.04 ≙ 16 X 6			Art. 01.099.02 ≙ 16 X 6	Art. 01.100.02 ≙ 16 X 6		
					Art. 01.100.03 ≙ 20 X 6		

Tutte le parti di questo catalogo - foto comprese - sono di proprietà Euro-Fer. La riproduzione, anche parziale, è vietata in ogni forma e con ogni mezzo. / Every part of this catalogue - photos included - is Euro-Fer's property. All forms of copying are strictly prohibited.

<p>RR</p>  <p>H.220 X L.110 mm. Art. 01.101.02 ≙ 20 X 6</p>	<p>RR</p>  <p>H.260 X L.115 mm. Art. 01.102 ≙ 12 X 6 Art. 01.102.01 ≙ 14 X 6 Art. 01.102.02 ≙ 16 X 6</p>	<p>RR</p>  <p>H.115 X L.95 mm. Art. 01.103 ≙ 12 X 6 Art. 01.103.01 ≙ 14 X 6 Art. 01.103.02 ≙ 16 X 6</p>	<p>RR</p>  <p>H.230 X L.80 mm. Art. 01.104 ≙ 12 X 6 Art. 01.104.01 ≙ 14 X 6 Art. 01.104.02 ≙ 16 X 6</p>	<p>RR</p>  <p>H.250 X L.75 mm. Art. 01.105 ≙ 12 X 6 Art. 01.105.01 ≙ 14 X 6 Art. 01.105.03 ≙ 16 X 6</p>	<p>RR</p>  <p>H.250 X L.100 mm. Art. 01.105.02 ≙ 10 X 10</p>
<p>RR</p>  <p>H.360 X L.125 mm. Art. 01.106 ≙ 12 X 6 Art. 01.106.01 ≙ 14 X 6 Art. 01.106.02 ≙ 16 X 6</p>	<p>RR</p>  <p>H.360 X L.130 mm. Art. 01.107 ≙ 12 X 12 Art. 01.107.02 ≙ 14 X 14</p>	<p>SF</p>  <p>H.400 X L.145 mm. Art. 01.107.01 ≙ 12 X 12</p>	<p>RR</p>  <p>H.100 X L.65 mm. Art. 01.108 ≙ 12 X 6 Art. 01.108.01 ≙ 14 X 6 Art. 01.108.02 ≙ 16 X 6</p>	<p>RR</p>  <p>H.120 X L.80 mm. Art. 01.109 ≙ 12 X 6 Art. 01.109.01 ≙ 14 X 6 Art. 01.109.02 ≙ 16 X 6</p>	<p>RR</p>  <p>H.135 X L.150 mm. Art. 01.110 ≙ 14 X 6 Art. 01.111 ≙ 16 X 6</p>
<p>RR</p>  <p>Rigato / Fluted H.300 X L.70 mm. Art. 01.113 ≙ 16 X 8</p>	<p>RR</p>  <p>H.460 X L.90 mm. Art. 01.113.01 ≙ 12 X 6</p>	<p>RR</p>  <p>Modello Scala / Scala Model H.460 X L.90 mm. Art. 01.113.02 ≙ 12 X 6</p>	<p>RR</p>  <p>Rigato / Fluted H.360 X L.110 mm. Art. 01.114 ≙ 12 X 6</p>	<p>TA</p>  <p>H.240 X L.55 mm. Art. 01.114.01 ≙ 12 X 3</p>	<p>TA</p>  <p>H.250 X L.55 mm. Art. 01.114.02 ≙ 12 X 3</p>
<p>TD</p>  <p>H.270 X L.90 mm. Art. 01.114.03 ≙ 12 X 5</p>	<p>TA</p>  <p>H.280 X L.45 mm. Art. 01.114.04 ≙ 12 X 3</p>	<p>RR</p>  <p>Rigato / Fluted H.180 X L.120 mm. Art. 01.114.05 ≙ 16 X 8</p>	<p>RR</p>  <p>Rigato / Fluted H.180 X L.120 mm. Art. 01.114.06 ≙ 16 X 8</p>	<p>RR</p>  <p>Rigato / Fluted H.210 X L.150 mm. Art. 01.114.07 ≙ 16 X 8</p>	<p>RR</p>  <p>Rigato / Fluted H.210 X L.150 mm. Art. 01.114.08 ≙ 16 X 8</p>



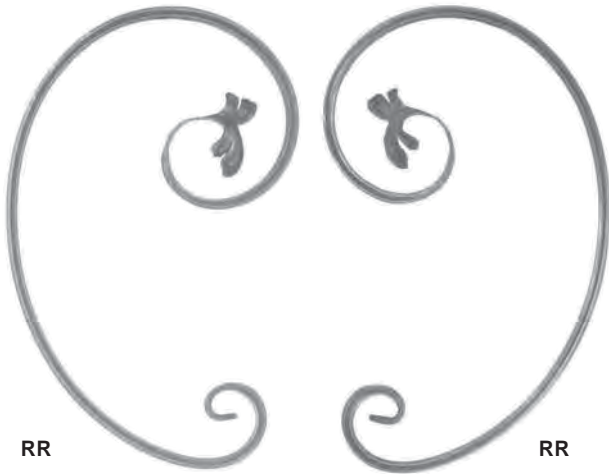

RR

RR

Rigato / Fluted  
H.360 X L.230 mm.  
Art. 01.114.09 ≙ 16 X 8

Rigato / Fluted  
H.360 X L.230 mm.  
Art. 01.114.10 ≙ 16 X 8



Rigato / Fluted  
H.480 X L.340 mm.  
Art. 01.114.11 ≙ 16 X 8

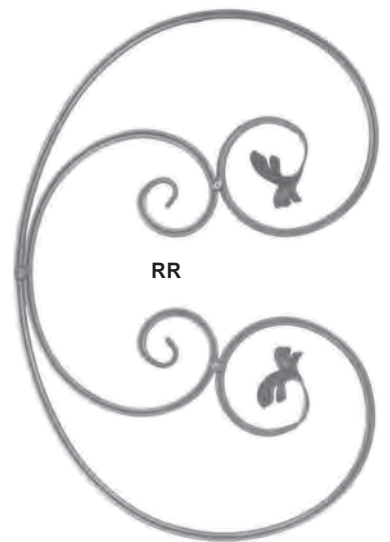

RR

Rigato / Fluted  
H.480 X L.320 mm.  
Art. 01.114.12 ≙ 16 X 8



Rigato / Fluted  
H.410 X L.150 mm.  
Art. 01.114.13 ≙ 16 X 8



Rigato / Fluted  
H.410 X L.150 mm.  
Art. 01.114.14 ≙ 16 X 8



RR

Rigato / Fluted  
H.510 X L.270 mm.  
Art. 01.114.15 ≙ 16 X 8



RR

Rigato / Fluted  
H.510 X L.270 mm.  
Art. 01.114.16 ≙ 16 X 8



Rigato / Fluted  
H.610 X L.250 mm.  
Art. 01.114.17 ≙ 16 X 8

Rigato / Fluted  
H.610 X L.250 mm.  
Art. 01.114.18 ≙ 16 X 8



RR

Rigato / Fluted  
H.240 X L.80 mm.  
Art. 01.114.19 ≙ 16 X 8



RR

Rigato / Fluted  
H.240 X L.80 mm.  
Art. 01.114.20 ≙ 16 X 8



Tutte le parti di questo catalogo - foto comprese - sono di proprietà Euro-Fer. La riproduzione, anche parziale, è vietata in ogni forma e con ogni mezzo. / Every part of this catalogue - photos included - is Euro-Fer's property. All forms of copying are strictly prohibited.



RR  
Rigato / Fluted  
H.190 X L.110 mm.  
Art. 01.114.21 ≙ 16 X 8



RR  
Rigato / Fluted  
H.270 X L.190 mm.  
Art. 01.114.22 ≙ 16 X 8



RR  
Rigato / Fluted  
H.350 X L.220 mm.  
Art. 01.114.23 ≙ 16 X 8



RR  
Rigato / Fluted  
H.210 X L.150 mm.  
Art. 01.114.24 ≙ 16 X 8



RR  
Rigato / Fluted  
H.360 X L.230 mm.  
Art. 01.114.26 ≙ 16 X 8



H.400 X L.150 mm.  
Art. 01.115 ≙ 12 X 6



H.400 X L.150 mm.  
Art. 01.116 ≙ 12 X 6



H.205 X L.150 mm.  
Art. 01.117 ≙ 12 X 6  
Art. 01.117.01 ≙ 14 X 6  
Art. 01.117.02 ≙ 16 X 6



H.250 X L.150 mm.  
Art. 01.118 ≙ 12 X 6  
Art. 01.118.03 ≙ 14 X 6  
Art. 01.118.04 ≙ 16 X 6  
Art. 01.118.05  
≙ 12 X 6 Mod. Scala / Scala Model  
Art. 01.118.06  
≙ 16 X 5 Martellato / Hammered



H.250 X L.150 mm.  
Art. 01.118.01 Ø 10

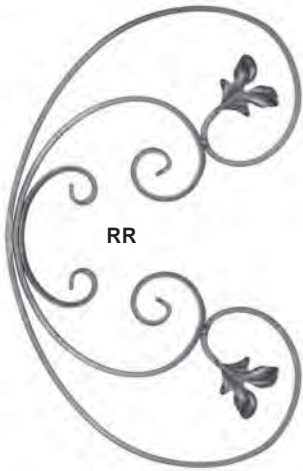

RR  
Liscio / Smooth  
H.500 x L.310 mm  
Art. 01.118.10 ≙ 12 x 6



RR  
H.200 X L.125 mm.  
Art. 01.119 ≙ 12 X 6



RR  
H.200 X L.125 mm.  
Art. 01.120 ≙ 12 X 6



RR  
H.115 X L.100 mm.  
Art. 01.120.01 ≙ 12 X 6



RR  
H.115 X L.100 mm.  
Art. 01.120.02 ≙ 12 X 6



RR  
H.80 X L.325 mm.  
Art. 01.121 ≙ 12 X 6  
Art. 01.121.01 ≙ 14 X 6



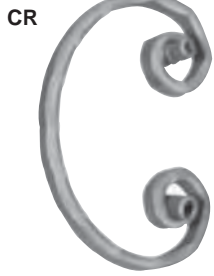

Martellato / Hammered  
H.175 X L.115 mm.  
Art. 01.122 ≙ 16 X 8

Martellato / Hammered  
H.125 X L.80 mm.  
Art. 01.123 ≙ 16 X 8



Martellato / Hammered  
H.115 X L.65 mm.  
Art. 01.124 ≙ 16 X 8

Martellato / Hammered  
H.225 X L.140 mm.  
Art. 01.125 ≙ 16 X 8



Martellato / Hammered  
H.190 X L.125 mm.  
Art. 01.126 ≙ 16 X 8

Martellato / Hammered  
H.190 X L.125 mm.  
Art. 01.127 ≙ 16 X 8



Martellato / Hammered  
H.270 X L.85 mm.  
Art. 01.128 ≙ 16 X 8

Martellato / Hammered  
H.270 X L.85 mm.  
Art. 01.129 ≙ 16 X 8



Martellato / Hammered  
H.310 X L.190 mm.  
Art. 01.130 ≙ 16 X 8

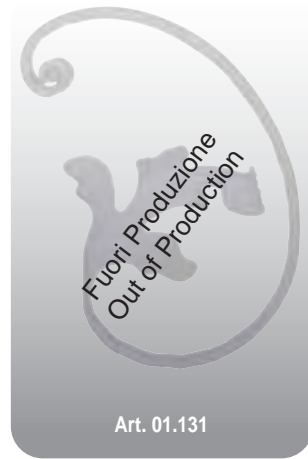

Art. 01.131



Tondo / Round  
H.290 X L.130 mm.  
Art. 01.131.01 Ø 10  
Art. 01.131.02 Ø 12  
Art. 01.131.30 Ø 14  
Art. 01.131.31 Ø 16

Tondo / Round  
H.360 X L.130 mm.  
Art. 01.131.03 Ø 10  
Art. 01.131.04 Ø 12  
Art. 01.131.32 Ø 14  
Art. 01.131.33 Ø 16

Tondo / Round  
H.360 X L.130 mm.  
Art. 01.131.05 Ø 10  
Art. 01.131.06 Ø 12  
Art. 01.131.34 Ø 14  
Art. 01.131.35 Ø 16





Tondo / Round  
H.135 X L.70 mm.  
Art. 01.131.07 Ø 12





Tondo / Round  
H.140 X L.85 mm.  
Art. 01.131.09 Ø 12



Tondo / Round  
H.230 X L.110 mm.  
Art. 01.131.11 Ø 10  
Art. 01.131.12 Ø 12  
Art. 01.131.36 Ø 14  
Art. 01.131.37 Ø 16

Tondo / Round  
H.220 X L.110 mm.  
Art. 01.131.13 Ø 10  
Art. 01.131.14 Ø 12  
Art. 01.131.38 Ø 14  
Art. 01.131.39 Ø 16

Tutte le parti di questo catalogo - foto comprese - sono di proprietà Euro-Fer. La riproduzione, anche parziale, è vietata in ogni forma e con ogni mezzo. / Every part of this catalogue - photos included - is Euro-Fer's property. All forms of copying are strictly prohibited.

	SF	SF	RR	PG	PG	
SF						
	Tondo / Round H.190 X L.100 mm. Art. 01.131.15 Ø 10 Art. 01.131.16 Ø 12 Art. 01.131.40 Ø 14	Tondo / Round H.290 X L.115 mm. Art. 01.131.17 Ø 10 Art. 01.131.18 Ø 12 Art. 01.131.41 Ø 14	Tondo / Round H.360 X L.120 mm. Art. 01.131.19 Ø 10 Art. 01.131.20 Ø 12 Art. 01.131.42 Ø 14	Tondo / Round H.370 X L.80 mm. Art. 01.131.21 Ø 12 Art. 01.131.43 Ø 14	Tondo / Round H.370 X L.120 mm. Art. 01.131.22 Ø 10 Art. 01.131.60 Ø 12 Art. 01.131.61 Ø 14	Tondo / Round H.550 X L.120 mm. Art. 01.131.23 Ø 10 Art. 01.131.62 Ø 12 Art. 01.131.63 Ø 14

PG	PG		TD	PG
				
Tondo / Round H.420 X L.210 mm. Art. 01.131.24 Ø 10 Art. 01.131.64 Ø 12 Art. 01.131.65 Ø 14	Tondo / Round H.700 X L.220 mm. Art. 01.131.25 Ø 12 Art. 01.131.66 Ø 14	H.420 X L.220 mm. Art. 01.131.29 Ø 10 Art. 01.131.67 Ø 12 Art. 01.131.68 Ø 14	H.270 x L.110 mm Art. 01.131.50 □ 8 X 8	H.690 x L.250 mm Art. 01.131.70 Ø 14 Art. 01.131.71 Ø 16

RR	RR
	
H.180 X L.400 mm. Art. 01.132 ≡ 16 X 5	H.160 X L.470 mm. Art. 01.133 ≡ 12 X 6

Tutte le parti di questo catalogo - foto comprese - sono di proprietà Euro-Fer. La riproduzione, anche parziale, è vietata in ogni forma e con ogni mezzo. / Every part of this catalogue - photos included - is Euro-Fer's property. All forms of copying are strictly prohibited.

RR



H.200 X L.730 mm.  
Art. 01.133.01 ≙ 12 X 6

RR



H.200 X L.770 mm.  
Art. 01.134 ≙ 16 X 4

RR



H.250 X L.900 mm.  
Art. 01.135 ≙ 16 X 4

RR



H.300 X L.900 mm.  
Art. 01.136 ≙ 20 X 5

RR



Modello Scala / Scala Model  
H.470 X L.750 mm.  
Art. 01.136.01 ≙ 14 X 6

RR



Martellato / Hammered  
H.400 X L.950 mm.  
Art. 01.136.02 ≙ 25 X 6

RR



Martellato sinistro / Hammered left  
H.530 X L.1630 mm.  
Art. 01.136.03 ≙ 25 X 6

Martellato destro / Hammered right  
H.530 X L.1630 mm.  
Art. 01.136.04 ≙ 25 X 6

Tutte le parti di questo catalogo - foto comprese - sono di proprietà Euro-Fer. La riproduzione, anche parziale, è vietata in ogni forma e con ogni mezzo. / Every part of this catalogue - photos included - is Euro-Fer's property. All forms of copying are strictly prohibited.





H.480 - Ø 550  
**Art. 01.136.05**  
 Base 40 x 40

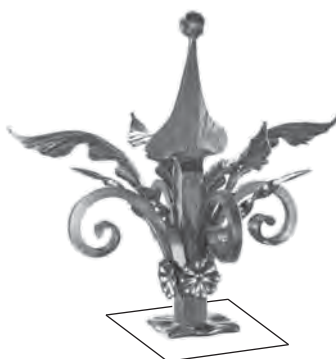

H.480 - Ø 550  
**Art. 01.136.06**  
 Base 110 x 110



H.580 X L.1250 mm.

**Art. 01.136.07** □ 16 X 16 Liscio sinistro / *Smooth left*  
**Art. 01.136.09** □ 16 X 16 Martellato sinistro / *Hammered left*

H.580 X L.1250 mm.

**Art. 01.136.08** □ 16 X 16 Liscio destro / *Smooth right*  
**Art. 01.136.10** □ 16 X 16 Martellato destro / *Hammered right*





H.560 X L.1720 mm.

Art. 01.136.11 □ 16 X 16 Liscio / Smooth

Art. 01.136.12 □ 16 X 16 Martellato / Hammered

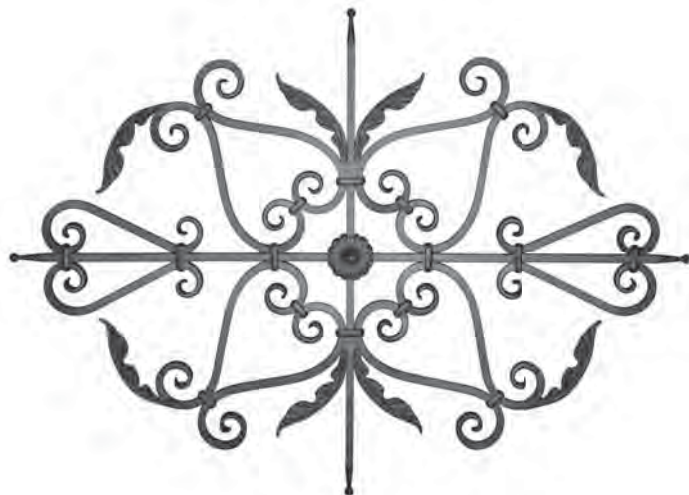

H.1420 X L.1030 mm.

Art. 01.136.13 □ 16 X 16 Liscio / Smooth

Art. 01.136.14 □ 16 X 16 Martellato / Hammered



H.1230 X L.1890 mm.

Art. 01.136.15 □ 16 X 16 Liscio sinistro / Smooth left

Art. 01.136.17 □ 16 X 16 Martellato sinistro / Hammered left



H.1230 X L.1890 mm.

Art. 01.136.16 □ 16 X 16 Liscio destro / Smooth right

Art. 01.136.18 □ 16 X 16 Martellato destro / Hammered right



Tutte le parti di questo catalogo - foto comprese - sono di proprietà Euro-Fer. La riproduzione, anche parziale, è vietata in ogni forma e con ogni mezzo. / Every part of this catalogue - photos included - is Euro-Fer's property. All forms of copying are strictly prohibited.

UR



H.260 x L.100 mm  
Liscio / Smooth  
Art. 01.136.40 □ 14 X14mm  
Art. 01.136.41 □ 12 X12mm  
Martellato / Hammered  
Art. 01.136.42 □ 14 X14mm  
Art. 01.136.43 □ 12 X12mm

UR



H.400 x L.110 mm  
Liscio / Smooth  
Art. 01.136.46 □ 14 X14mm  
Art. 01.136.47 □ 12 X12mm  
Martellato / Hammered  
Art. 01.136.48 □ 14 X14mm  
Art. 01.136.49 □ 12 X12mm

UR



H.200 X L.95 mm.  
Art. 01.137 □ 16 X 16

UR



Martellato / Hammered  
H.200 X L.95 mm.  
Art. 01.138 □ 16 X 16

UR



H.200 X L.95 mm.  
Art. 01.139 □ 16 X 16

UR



Martellato / Hammered  
H.200 X L.95 mm.  
Art. 01.140 □ 16 X 16

UR



H.220 X L.115 mm.  
Art. 01.141 □ 16 X 16

UR



Martellato / Hammered  
H.220 X L.115 mm.  
Art. 01.142 □ 16 X 16

UR



H.240 X L.160 mm.  
Art. 01.143 □ 16 X 16

UR



Martellato / Hammered  
H.240 X L.160 mm.  
Art. 01.144 □ 16 X 16

UR



H.270 X L.100 mm.  
Art. 01.145 □ 16 X 16

UR



Martellato / Hammered  
H.270 X L.100 mm.  
Art. 01.146 □ 16 X 16

UR



H.260 X L.135 mm.  
Art. 01.147 □ 16 X 16

UR



Martellato / Hammered  
H.260 X L.135 mm.  
Art. 01.148 □ 16 X 16

UR



H.280 X L.105 mm.  
Art. 01.149 □ 16 X 16

UR



Martellato / Hammered  
H.280 X L.105 mm.  
Art. 01.150 □ 16 X 16

UR



H.370 X L.190 mm.  
Art. 01.151 □ 16 X 16

UR



Martellato / Hammered  
H.370 X L.190 mm.  
Art. 01.152 □ 16 X 16

UR



H.450 X L.200 mm.  
Art. 01.153 □ 16 X 16

UR



Martellato / Hammered  
H.450 X L.200 mm.  
Art. 01.154 □ 16 X 16

UR



H.490 X L.170 mm.  
Art. 01.155 □ 16 X 16

UR



Martellato / Hammered  
H.490 X L.170 mm.  
Art. 01.156 □ 16 X 16

UR



H.510 X L.195 mm.  
Art. 01.157 □ 16 X 16

UR



Martellato / Hammered  
H.510 X L.195 mm.  
Art. 01.158 □ 16 X 16

Tutte le parti di questo catalogo - foto comprese - sono di proprietà Euro-Fer. La riproduzione, anche parziale, è vietata in ogni forma e con ogni mezzo. / Every part of this catalogue - photos included - is Euro-Fer's property. All forms of copying are strictly prohibited.



H.540 X L.200 mm.  
Art. 01.159 □ 16 X 16



Martellato / Hammered  
H.540 X L.200 mm.  
Art. 01.160 □ 16 X 16



H.810 X L.540 mm.  
Art. 01.161 □ 16 X 16



Martellato / Hammered  
H.810 X L.540 mm.  
Art. 01.162 □ 16 X 16



H.200 X L.85 mm.  
Art. 01.163 □ 16 X 16



Martellato / Hammered  
H.200 X L.85 mm.  
Art. 01.164 □ 16 X 16



H.260 X L.95 mm.  
Art. 01.165 □ 16 X 16



Martellato / Hammered  
H.260 X L.95 mm.  
Art. 01.166 □ 16 X 16



H.365 X L.170 mm.  
Art. 01.167 □ 16 X 16



Martellato / Hammered  
H.365 X L.170 mm.  
Art. 01.168 □ 16 X 16



H.400 X L.185 mm.  
Art. 01.169 □ 16 X 16



Martellato / Hammered  
H.400 X L.185 mm.  
Art. 01.170 □ 16 X 16



H.415 X L.190 mm.  
Art. 01.171 □ 16 X 16



Martellato / Hammered  
H.415 X L.190 mm.  
Art. 01.172 □ 16 X 16



H.420 X L.150 mm.  
Art. 01.173 □ 16 X 16



Martellato / Hammered  
H.420 X L.150 mm.  
Art. 01.174 □ 16 X 16



H.430 X L.205 mm.  
Art. 01.175 □ 16 X 16



Martellato / Hammered  
H.430 X L.205 mm.  
Art. 01.176 □ 16 X 16



H.450 X L.180 mm.  
Art. 01.177 □ 16 X 16



Martellato / Hammered  
H.450 X L.180 mm.  
Art. 01.178 □ 16 X 16



H.480 X L.140 mm.  
Art. 01.179 □ 16 X 16



Martellato / Hammered  
H.480 X L.140 mm.  
Art. 01.180 □ 16 X 16



H.480 X L.160 mm.  
Art. 01.181 □ 16 X 16



Martellato / Hammered  
H.480 X L.160 mm.  
Art. 01.182 □ 16 X 16

Tutte le parti di questo catalogo - foto comprese - sono di proprietà Euro-Fer. La riproduzione, anche parziale, è vietata in ogni forma e con ogni mezzo. / Every part of this catalogue - photos included - is Euro-Fer's property. All forms of copying are strictly prohibited.





Tutte le parti di questo catalogo - foto comprese - sono di proprietà Euro-Fer. La riproduzione, anche parziale, è vietata in ogni forma e con ogni mezzo. / Every part of this catalogue - photos included - is Euro-Fer's property. All forms of copying are strictly prohibited.



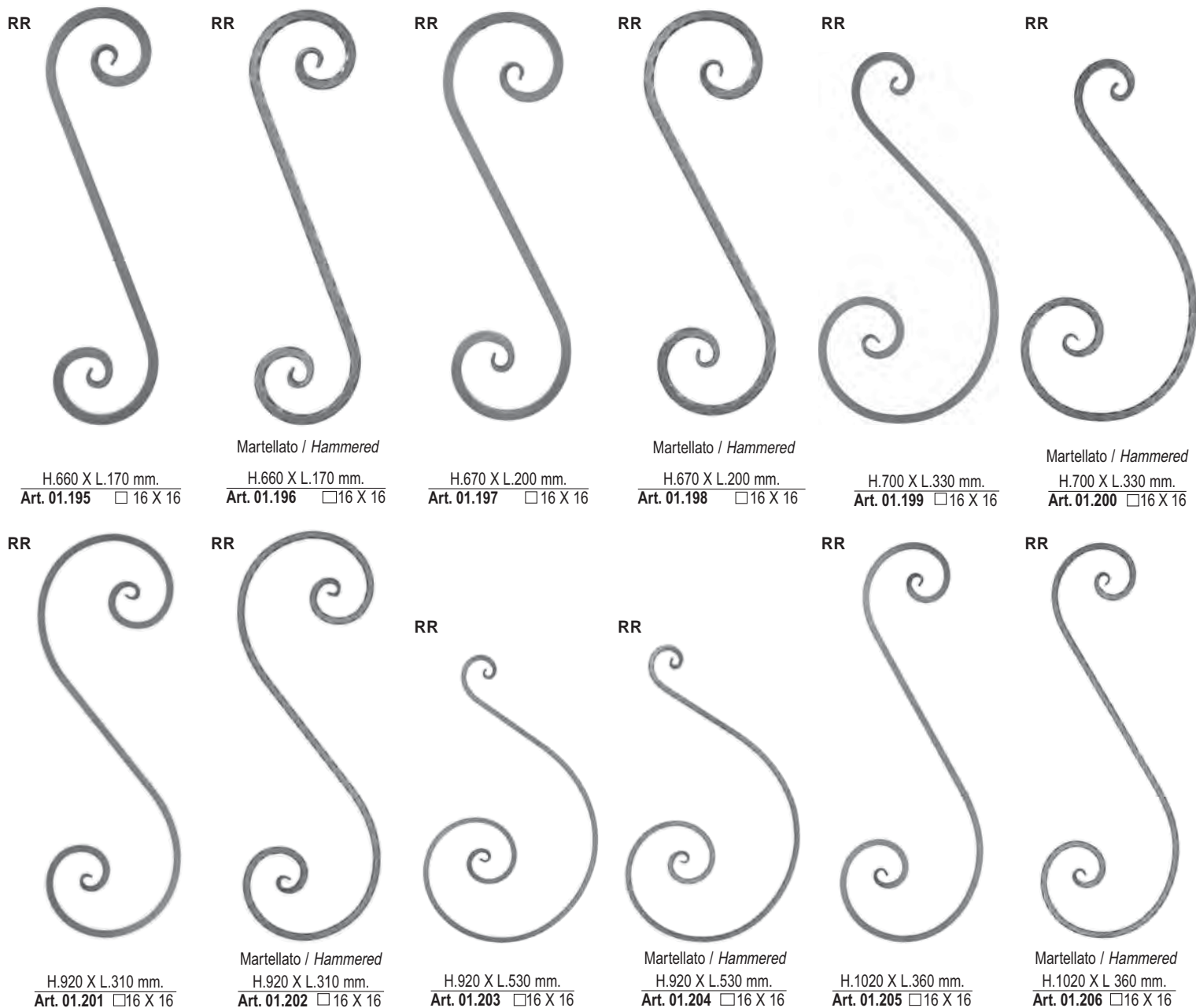

Tutte le parti di questo catalogo - foto comprese - sono di proprietà Euro-Fer. La riproduzione, anche parziale, è vietata in ogni forma e con ogni mezzo. / Every part of this catalogue - photos included - is Euro-Fer's property. All forms of copying are strictly prohibited.

RR



H.170 X L.100 mm.  
Art. 01.207 □ 16 X 16

RR



Martellato / Hammered  
H.170 X L.100 mm.  
Art. 01.208 □ 16 X 16

RR



H.210 X L.115 mm.  
Art. 01.209 □ 16 X 16

RR



Martellato / Hammered  
H.210 X L.115 mm.  
Art. 01.210 □ 16 X 16

RR



H.220 X L.170 mm.  
Art. 01.211 □ 16 X 16

RR



Martellato / Hammered  
H.220 X L.170 mm.  
Art. 01.212 □ 16 X 16

RR



H.250 X L.180 mm.  
Art. 01.213 □ 16 X 16

RR



Martellato / Hammered  
H.250 X L.180 mm.  
Art. 01.214 □ 16 X 16

RR



H.270 X L.190 mm.  
Art. 01.215 □ 16 X 16

RR



Martellato / Hammered  
H.270 X L.190 mm.  
Art. 01.216 □ 16 X 16

RR



H.280 X L.150 mm.  
Art. 01.217 □ 16 X 16

RR



Martellato / Hammered  
H.280 X L.150 mm.  
Art. 01.218 □ 16 X 16

RR



H.310 X L.200 mm.  
Art. 01.219 □ 16 X 16

RR



Martellato / Hammered  
H.310 X L.200 mm.  
Art. 01.220 □ 16 X 16

RR



H.320 X L.210 mm.  
Art. 01.221 □ 16 X 16

RR



Martellato / Hammered  
H.320 X L.210 mm.  
Art. 01.222 □ 16 X 16

RR



H.320 X L.205 mm.  
Art. 01.223 □ 16 X 16

RR



H.320 X L.240 mm.  
Art. 01.225 □ 16 X 16

RR



Martellato / Hammered  
H.320 X L.240 mm.  
Art. 01.226 □ 16 X 16

RR



H.350 X L.260 mm.  
Art. 01.227 □ 16 X 16

RR



Martellato / Hammered  
H.350 X L.260 mm.  
Art. 01.228 □ 16 X 16

RR



H.350 X L.280 mm.  
Art. 01.229 □ 16 X 16

RR



Martellato / Hammered  
H.350 X L.280 mm.  
Art. 01.230 □ 16 X 16

RR



H.420 X L.310 mm.  
Art. 01.231 □ 16 X 16



Tutte le parti di questo catalogo - foto comprese - sono di proprietà Euro-Fer. La riproduzione, anche parziale, è vietata in ogni forma e con ogni mezzo. / Every part of this catalogue - photos included - is Euro-Fer's property. All forms of copying are strictly prohibited.



RR



H.450 X L.330 mm.  
Art. 01.233 □ 16 X 16

RR



Martellato / Hammered  
H.450 X L.330 mm.  
Art. 01.234 □ 16 X 16

RR



H.480 X L.230 mm.  
Art. 01.235 □ 16 X 16

RR



Martellato / Hammered  
H.480 X L.230 mm.  
Art. 01.236 □ 16 X 16

RR



H.510 X L.210 mm.  
Art. 01.237 □ 16 X 16

RR



Martellato / Hammered  
H.510 X L.210 mm.  
Art. 01.238 □ 16 X 16

RR



H.540 X L.300 mm.  
Art. 01.239 □ 16 X 16

RR



Martellato / Hammered  
H.540 X L.300 mm.  
Art. 01.240 □ 16 X 16

RR



H.580 X L.410 mm.  
Art. 01.241 □ 16 X 16

RR



Martellato / Hammered  
H.580 X L.410 mm.  
Art. 01.242 □ 16 X 16



NC



H.200 X L.85 mm.  
Art. 01.243 □ 10 X 10

NC



H.240 X L.110 mm.  
Art. 01.244 □ 10 X 10

NC



H.250 X L.110 mm.  
Art. 01.245 □ 10 X 10

NC



H.270 X L.135 mm.  
Art. 01.246 □ 10 X 10

NC



H.350 X L.135 mm.  
Art. 01.247 □ 10 X 10

NC



H.420 X L.150 mm.  
Art. 01.248 □ 10 X 10

NC



H.470 X L.220 mm.  
Art. 01.249 □ 10 X 10

NC



H.450 X L.135 mm.  
Art. 01.250 □ 10 X 10

NC



H.330 X L.230 mm.  
Art. 01.251 □ 10 X 10

NC



H.440 X L.290 mm.  
Art. 01.252 □ 10 X 10

NC



H.540 X L.250 mm.  
Art. 01.253 □ 10 X 10

NC



H.570 X L.350 mm.  
Art. 01.254 □ 10 X 10

RR





















Forgiato / Forged  
H.360 X L.125 mm.  
Art. 01.255 □ 14 X 14

RR



Forgiato / Forged  
H.360 X L.125 mm.  
Art. 01.256 □ 14 X 14

Tutte le parti di questo catalogo - foto comprese - sono di proprietà Euro-Fer. La riproduzione, anche parziale, è vietata in ogni forma e con ogni mezzo. / Every part of this catalogue - photos included - is Euro-Fer's property. All forms of copying are strictly prohibited.

<p>RR</p> 	<p>RR</p> 	<p>RR</p> 	<p>RR</p> 	<p>RR</p> 	<p>RR</p> 
<p>Tondo Forgiato / Round Forged H.360 X L.125 mm. Art. 01.257 □ 14</p>	<p>Tondo / Round H.360 X L.125 mm. Ø 12 Art. 01.258</p>	<p>Forgiato / Forged H.360 X L.125 mm. Art. 01.260 □ 14 X 14</p>	<p>Forgiato / Forged H.360 X L.125 mm. Art. 01.261 □ 14 X 14</p>	<p>Tondo Forgiato / Round Forged H.360 X L.125 mm. Art. 01.262 □ 14</p>	<p>Tondo / Round H.360 X L.125 mm. Ø 12 Art. 01.263</p>
	<p>H.600 X L.125 mm. Ø 12 Art. 01.259</p>				<p>H.600 X L.125 mm. Ø 12 Art. 01.264</p>
<p>RR</p> 	<p>RR</p> 	<p>PP pallina piccola small ball</p> 	<p>PG pallina grande large ball</p> 	<p>PP</p> 	<p>PP</p> 
<p>H.400 X L.200 mm. Art. 01.265 □ 12 X 12 Art. 01.266 □ 14 X 14</p>	<p>Martellato / Hammered H.400 X L.200 mm. Art. 01.267 □ 12 X 12 Art. 01.268 □ 14 X 14</p>			<p>Forgiato / Forged H.360 X L.125 mm. Art. 01.269 □ 14 X 14</p>	<p>Forgiato / Forged H.360 X L.125 mm. Art. 01.270 □ 14 X 14</p>
<p>PP</p> 	<p>PG</p> 	<p>PG</p> 	<p>PP</p> 	<p>PP</p> 	<p>PS</p> 
<p>Tondo Forgiato / Round Forged H.360 X L.125 mm. Art. 01.271 □ 14</p>	<p>Martellato / Hammered H.360 X L.125 mm. □ 14 X 14 Art. 01.272</p>	<p>Martellato / Hammered H.360 X L.125 mm. □ 14 X 14 Art. 01.274</p>	<p>Forgiato / Forged H.360 X L.125 mm. Art. 01.276 □ 14 X 14</p>	<p>Forgiato / Forged H.360 X L.125 mm. Art. 01.276 □ 14 X 14</p>	<p>Forgiato / Forged H.360 X L.130 mm. Art. 01.276.01 □ 14 X 14</p>
	<p>H.600 X L.125 mm. □ 14 X 14 Art. 01.273</p>	<p>H.600 X L.125 mm. □ 14 X 14 Art. 01.275</p>			



Tutte le parti di questo catalogo - foto comprese - sono di proprietà Euro-Fer. La riproduzione, anche parziale, è vietata in ogni forma e con ogni mezzo. / Every part of this catalogue - photos included - is Euro-Fer's property. All forms of copying are strictly prohibited.



PP  
Forgiato / Forged  
H.360 X L.125 mm.  
Art. 01.277 □ 14 X 14



PP  
Tondo Forgiato / Round Forged  
H.360 X L.125 mm.  
Art. 01.278 Ø 14



PG  
Martellato / Hammered  
H.360 X L.125 mm.  
Art. 01.279 □ 14 X 14



PG  
Martellato / Hammered  
H.360 X L.125 mm.  
Art. 01.281 □ 14 X 14



PG  
Martellato / Hammered □ 12 X 12  
Art. 01.283 H.360 X L.125 mm.  
Art. 01.284 H.600 X L.125 mm

H.600 X L.125 mm.  
Art. 01.280 □ 14 X 14

H.600 X L.125 mm.  
Art. 01.282 □ 14 X 14

Martellato / Hammered □ 14 X 14  
Art. 01.285 H.360 X L.125 mm  
Art. 01.286 H.600 X L.125 mm



PG  
□ 12 X 12  
Art. 01.287 H.360 X L.125 mm.  
Art. 01.288 H.600 X L.125 mm  
□ 14 X 14  
Art. 01.289 H.360 X L.125 mm  
Art. 01.290 H.600 X L.125 mm



PG  
Martellato / Hammered  
H.250 X L.150 mm.  
Art. 01.291 □ 12 X 12  
Art. 01.292 □ 14 X 14



CR  
chiocciola rigata  
fluted spiral



CR  
Mod. Scala / Scala Model  
H.115 X L.75 mm.  
Art. 01.293 □ 8 X 8



CR  
Modello Scala / Scala Model  
H.180 X L.90 mm.  
Art. 01.294 ≡ 12 X 6  
Art. 01.295 ≡ 14 X 6  
Art. 01.295.01 ≡ 16 X 6



CR  
Modello Scala / Scala Model  
H.280 X L.125 mm.  
Art. 01.296 ≡ 12 X 6  
Art. 01.297 ≡ 14 X 6  
Art. 01.297.01 ≡ 16 X 6



CR  
Modello Scala / Scala Model  
H.350 X L.135 mm.  
Art. 01.298 ≡ 12 X 6  
Art. 01.299 ≡ 14 X 6  
Art. 01.299.01 ≡ 16 X 6



CR  
Modello Scala / Scala Model  
H.450 X L.145 mm.  
Art. 01.300 ≡ 12 X 6  
Art. 01.301 ≡ 14 X 6  
Art. 01.301.01 ≡ 16 X 6



CR  
H.280 X L.125 mm.  
Art. 01.302 ≡ 12 X 6  
Art. 01.303 ≡ 14 X 6  
Art. 01.303.01 ≡ 16 X 6



CR  
H.350 X L.135 mm.  
Art. 01.304 ≡ 12 X 6  
Art. 01.305 ≡ 14 X 6  
Art. 01.305.01 ≡ 16 X 6



CR  
H.450 X L.145 mm.  
Art. 01.306 ≡ 12 X 6  
Art. 01.307 ≡ 14 X 6  
Art. 01.307.01 ≡ 16 X 6



CR



H.125 X L.80 mm.  
Art. 01.308 ≙ 12 X 6  
Art. 01.309 ≙ 14 X 6

CR



H.145 X L.70 mm.  
Art. 01.310 ≙ 12 X 6  
Art. 01.311 ≙ 14 X 6

CR



H.250 X L.130 mm.  
Art. 01.312 ≙ 12 X 6  
Art. 01.313 ≙ 14 X 6

CR



Tondo / Round  
H.290 X L.115 mm.  
Art. 01.314 Ø 12  
Art. 01.314.01 Ø 14

CR



Tondo / Round  
H.350 X L.125 mm.  
Art. 01.315 Ø 12  
Art. 01.315.01 Ø 14

CR



Tondo / Round  
H.500 X L.100 mm.  
Art. 01.321 Ø 12  
Art. 01.321.01 Ø 14

CR



Tondo / Round  
H.390 X L.130 mm.  
Art. 01.316 Ø 12  
Art. 01.316.01 Ø 14

CR



Tondo / Round  
H.450 X L.130 mm.  
Art. 01.317 Ø 12  
Art. 01.317.01 Ø 14

CR



Tondo / Round  
H.180 X L.105 mm.  
Art. 01.318 Ø 12  
Art. 01.318.01 Ø 14

CR



Tondo / Round  
H.220 X L.110 mm.  
Art. 01.319 Ø 12  
Art. 01.319.01 Ø 14

CR



Tondo / Round  
H.190 X L.105 mm.  
Art. 01.320 Ø 12  
Art. 01.320.01 Ø 14

CR



Tondo Martellato  
Hammered Round  
H.290 X L.115 mm.  
Art. 01.322 Ø 12  
Art. 01.322.01 Ø 14

CR



Tondo Martellato  
Hammered Round  
H.350 X L.125 mm.  
Art. 01.323 Ø 12  
Art. 01.323.01 Ø 14

CR



Tondo Martellato  
Hammered Round  
H.390 X L.130 mm.  
Art. 01.324 Ø 12  
Art. 01.324.01 Ø 14

CR



Tondo Martellato  
Hammered Round  
H.450 X L.130 mm.  
Art. 01.325 Ø 12  
Art. 01.325.01 Ø 14

CR



Tondo Martellato  
Hammered Round  
H.180 X L.105 mm.  
Art. 01.326 Ø 12  
Art. 01.326.01 Ø 14

CR



Tondo Martellato  
Hammered Round  
H.220 X L.110 mm.  
Art. 01.327 Ø 12  
Art. 01.327.01 Ø 14

CR



Tondo Martellato  
Hammered Round  
H.190 X L.105 mm.  
Art. 01.328 Ø 12  
Art. 01.328.01 Ø 14

CR



Tondo Martellato  
Hammered Round  
H.500 X L.100 mm.  
Art. 01.329 Ø 12

RR



Martellato / Hammered  
H.380 X L.200 mm.  
Art. 01.330 ≙ 25 X 6

RR



Martellato / Hammered  
H.470 X L.270 mm.  
Art. 01.331 ≙ 25 X 6

RR



Martellato / Hammered  
H.640 X L.130 mm.  
Art. 01.332 ≙ 25 X 6

RR



Martellato / Hammered  
H.300 X L.150 mm.  
Art. 01.333 ≙ 25 X 6



Martellato / Hammered  
H.710 X L.305 mm.  
Art. 01.334  $\neq$  25 X 6



Martellato / Hammered  
H.700 X L.300 mm.  
Art. 01.335  $\neq$  25 X 6



Martellato / Hammered  
H.170 X L.115 mm.  
Art. 01.336  $\square$  12 X 12  
Art. 01.337  $\square$  14 X 14

Liscio / Smooth  
H.170 X L.115 mm.  
Art. 01.338  $\square$  12 X 12  
Art. 01.339  $\square$  14 X 14



Tondo / Round  
H.200 X L.135 mm.  
Art. 01.340  $\varnothing$  12  
Art. 01.341  $\varnothing$  14  
Art. 01.342  $\varnothing$  16



Liscio / Smooth  
H.200 X L.135 mm.  
Art. 01.343  $\square$  12 X 12  
Art. 01.344  $\square$  14 X 14  
Art. 01.345  $\square$  16 X 16

Martellato / Hammered  
H.200 X L.135 mm.  
Art. 01.346  $\square$  12 X 12  
Art. 01.347  $\square$  14 X 14  
Art. 01.348  $\square$  16 X 16



Martellato / Hammered  
H.360 X L.130 mm.  
Art. 01.349  $\square$  12 X 12  
Art. 01.350  $\square$  14 X 14

Liscio / Smooth  
H.360 X L.130 mm.  
Art. 01.351  $\square$  12 X 12  
Art. 01.352  $\square$  14 X 14



Tondo / Round  
H.350 X L.150 mm.  
Art. 01.353  $\varnothing$  12  
Art. 01.354  $\varnothing$  14  
Art. 01.355  $\varnothing$  16



Liscio / Smooth  
H.350 X L.150 mm.  
Art. 01.356  $\square$  12 X 12  
Art. 01.357  $\square$  14 X 14  
Art. 01.358  $\square$  16 X 16

Martellato / Hammered  
H.350 X L.150 mm.  
Art. 01.359  $\square$  12 X 12  
Art. 01.360  $\square$  14 X 14  
Art. 01.361  $\square$  16 X 16



Liscio / Smooth  
H.350 X L.150 mm.  
Art. 01.362  $\square$  12 X 12  
Art. 01.363  $\square$  14 X 14  
Art. 01.364  $\square$  16 X 16

Martellato / Hammered  
H.350 X L.150 mm.  
Art. 01.365  $\square$  12 X 12  
Art. 01.366  $\square$  14 X 14  
Art. 01.367  $\square$  16 X 16



Tondo / Round  
H.350 X L.150 mm.  
Art. 01.368  $\varnothing$  12  
Art. 01.369  $\varnothing$  14  
Art. 01.370  $\varnothing$  16



Liscio / Smooth  
H.135 X L.80 mm.  
Art. 01.371  $\neq$  14 X 6



Liscio / Smooth  
H.145 X L.90 mm.  
Art. 01.372  $\varnothing$  10  
Art. 01.372.01  $\varnothing$  12



Liscio / Smooth  
H.290 X L.120 mm.  
Art. 01.373  $\neq$  14 X 6



Mod. Scala / Scala model  
H.290 X L.120 mm.  
Art. 01.374  $\neq$  14 X 6



Liscio / Smooth  
H.220 X L.110 mm.  
Art. 01.375  $\neq$  14 X 6



Liscio / Smooth  
H.200 X L.100 mm.  
Art. 01.376  $\neq$  14 X 6  
Art. 01.376.02  $\neq$  16 X 8



Liscio / Smooth  
H.250 X L.75 mm.  
Art. 01.377  $\neq$  14 X 6

PS  
pallina "a sole"  
sun ball



PS



Liscio / Smooth  
H.135 X L.80 mm.  
Art. 01.400 ≡ 14 X 6

PS



Liscio / Smooth  
H.190 X L.65 mm.  
Art. 01.401 □ 8 X 8



PS



Liscio / Smooth  
H.200 X L.100 mm.  
Art. 01.402 ≡ 14 X 6



PS



Liscio / Smooth  
H.220 X L.110 mm.  
Art. 01.403 ≡ 14 X 6

PS



Liscio / Smooth  
H.360 X L.125 mm.  
Art. 01.404 □ 12 X 12  
Art. 01.404.01 □ 14 X 14  
Art. 01.404.02 □ 16 X 16

PS



Liscio / Smooth  
H.350 X L.150 mm.  
Art. 01.405 □ 12 X 12  
Art. 01.405.01 □ 14 X 14  
Art. 01.405.02 □ 16 X 16

PS



Liscio / Smooth  
H.350 X L.150 mm.  
Art. 01.406 Ø 12  
Art. 01.406.01 Ø 14

PS



Liscio / Smooth  
H.420 X L.220 mm.  
Art. 01.407 Ø 10  
Art. 01.407.01 Ø 12  
Art. 01.407.02 Ø 14

PS



Liscio / Smooth  
H.550 X L.125 mm.  
Art. 01.408 Ø 10  
Art. 01.408.01 Ø 12  
Art. 01.408.02 Ø 14  
Art. 01.408.03 Ø 16

PS



Liscio / Smooth  
H.250 X L.75 mm.  
Art. 01.409 ≡ 14 X 6



RR



Rigato -Martellato-Attorcigliato  
Fluted-Hammered and Twisted  
H.800 X L.220 mm.  
Art. 01.450 □ 14 X 14



RR



Rigato -Martellato-Attorcigliato  
Fluted-Hammered and Twisted  
H.500 X L.145 mm.  
Art. 01.451 □ 14 X 14



RR



Rigato -Martellato-Attorcigliato  
Fluted-Hammered and Twisted  
H.330 X L.130 mm.  
Art. 01.452 □ 14 X 14





**CS**  
chiocciola schiacciata  
*pressed spiral*



Liscio / Smooth  
H.200 x L.125 mm  
Art. 01.490 Ø 14  
Art. 01.491 Ø 16  
Art. 01.492 Ø 18  
Art. 01.493 Ø 20

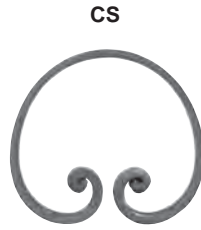

Liscio / Smooth  
H.160 x L.175 mm  
Art. 01.500 □ 12X12  
Art. 01.501 ≇ 16x8  
Art. 01.502 ≇ 20x10  
Art. 01.503 Ø 10



Liscio / Smooth  
H.155 X L.95 mm.  
Art. 01.504 □ 12 X 12  
Art. 01.505 ≇ 16 X 8  
Art. 01.506 ≇ 20 X 10  
Art. 01.507 Ø 10



Liscio / Smooth  
H.270 X L.85 mm.  
Art. 01.508 □ 12 X 12  
Art. 01.509 ≇ 16 X 8  
Art. 01.510 ≇ 20 X 10  
Art. 01.511 Ø 10



Liscio / Smooth  
H.180 X L.90 mm.  
Art. 01.512 □ 12 X 12  
Art. 01.513 ≇ 16 X 8  
Art. 01.514 ≇ 20 X 10  
Art. 01.515 Ø 10



Liscio / Smooth  
H.290 X L.115 mm.  
Art. 01.516 □ 12 X 12  
Art. 01.517 ≇ 16 X 8  
Art. 01.518 ≇ 20 X 10  
Art. 01.519 Ø 10



Liscio / Smooth  
H.350 x L.110 mm  
Art. 01.519.10 □ 16 X16



Liscio / Smooth  
H.420 x L.165 mm  
Art. 01.519.15 □ 16 X16



Liscio / Smooth  
H.120 X L.70 mm.  
Art. 01.520 Ø 10



Liscio / Smooth  
H.140 X L.70 mm.  
Art. 01.521 Ø 10



Liscio / Smooth  
H.140 X L.80 mm.  
Art. 01.522 Ø 10



Liscio / Smooth  
H.210 x L.140 mm  
Art. 01.522.05 Ø 10  
Art. 01.522.06 □ 12  
Art. 01.522.07 ≇ 16 x 8  
Art. 01.522.08 ≇ 20 x 10



Liscio / Smooth  
H.410 x L.270 mm  
Art. 01.522.10 Ø 10  
Art. 01.522.11 □ 12  
Art. 01.522.12 ≇ 20 x 10  
Art. 01.522.13 ≇ 16 x 8



RR



Liscio / Smooth  
H.294 x L.100 mm

Art. 01.523  $\neq$  14 X 6

Art. 01.523.01  $\neq$  16 X 6

Art. 01.523.02  $\neq$  16 X 8 **NEW**



RR



Mod. Scala / Scala Model  
H.294 x L.100 mm

Art. 01.524  $\neq$  14 X 6

Art. 01.524.01  $\neq$  16 X 6

Art. 01.524.02  $\neq$  16 X 8 **NEW**

RR



Liscio / Smooth  
H.200 x L.200 mm  
Art. 01.525  $\neq$  12 x 6



Liscio / Smooth  
H.120 x L.100 mm  
Art. 01.526  $\neq$  12 x 6  
H.125 x L.100 mm  
Art. 01.527  $\square$  12

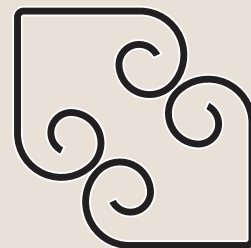
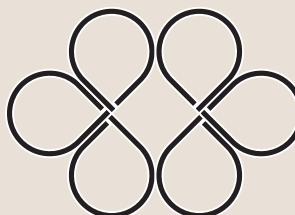
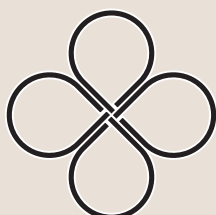
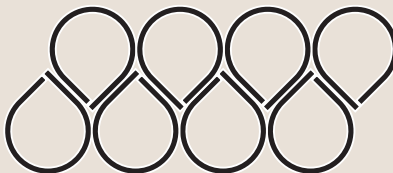
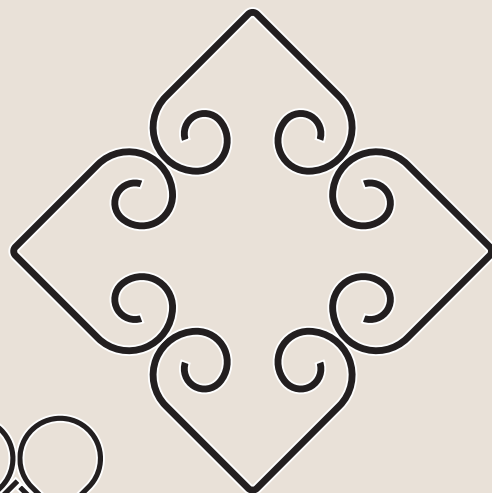
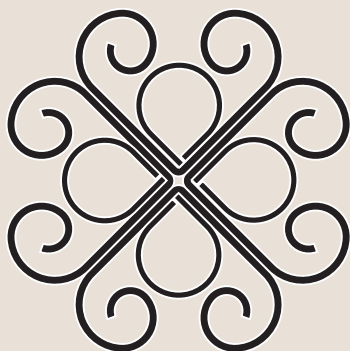



RR



Liscio / Smooth  
H.750 X L.260 mm.  
Art. 01.528  $\neq$  30 X 8

TA



H.500 X L.100 mm.  
Art. 01.529  $\neq$  12 X 3

RR



H.650 X L.170 mm.  
Art. 01.530  $\neq$  16 X 6

RR



H.780 X L.280 mm.  
Art. 01.531  $\varnothing$  25



Tutte le parti di questo catalogo - foto comprese - sono di proprietà Euro-Fer. La riproduzione, anche parziale, è vietata in ogni forma e con ogni mezzo. / Every part of this catalogue - photos included - is Euro-Fer's property. All forms of copying are strictly prohibited.



N.B. Tutti i cerchi non sono saldati  
 NOTE: All the circles are not welded.

H: Diametro esterno / External diameter



Cerchi con sezione in tondo e tondo martellato  
 Round section circles and hammered circles

Ø 8 mm.	
Art. 02.001	H 100 mm.
Art. 02.002	H 120 mm.
Art. 02.003	H 130 mm.
Art. 02.003.01	H 90 mm.
Art. 02.003.02	H 105 mm.
Art. 02.003.03	H 110 mm.
Art. 02.003.04	H 135 mm.
Art. 02.003.05	H 180 mm.
Art. 02.003.06	H 250 mm.
Art. 02.003.07	H 270 mm.

Ø 10 mm.	
Art. 02.004	H 100 mm.
Art. 02.005	H 120 mm.
Art. 02.006	H 130 mm.
Art. 02.006.01	H 90 mm.
Art. 02.006.02	H 110 mm.
Art. 02.006.03	H 135 mm.
Art. 02.006.04	H 140 mm.
Art. 02.006.05	H 180 mm.
Art. 02.006.06	H 250 mm.
Art. 02.006.07	H 270 mm.

Ø 12 mm.	
Art. 02.006.50	H 115 mm.
Art. 02.007	H 100 mm.
Art. 02.008	H 120 mm.
Art. 02.009	H 130 mm.
Art. 02.009.01	H 110 mm.
Art. 02.009.02	H 135 mm.
Art. 02.009.03	H 140 mm.
Art. 02.009.04	H 180 mm.
Art. 02.009.05	H 210 mm.
Art. 02.009.06	H 250 mm.
Art. 02.009.07	H 275 mm.

Mart. a caldo / Hot hammered Ø 12 mm.	
Art. 02.007.01	H 100 mm.
Art. 02.007.02	H 110 mm.
Art. 02.007.03	H 120 mm.
Art. 02.007.04	H 130 mm.
Art. 02.007.05	H 135 mm.
Art. 02.007.06	H 140 mm.
Art. 02.007.07	H 180 mm.
Art. 02.007.08	H 210 mm.
Art. 02.007.09	H 250 mm.
Art. 02.007.10	H 275 mm.

Ø 14 mm.	
Art. 02.009.08	H 100 mm.
Art. 02.009.09	H 110 mm.
Art. 02.009.10	H 115 mm.
Art. 02.009.11	H 120 mm.
Art. 02.009.12	H 125 mm.
Art. 02.009.13	H 130 mm.
Art. 02.009.14	H 135 mm.
Art. 02.009.15	H 140 mm.
Art. 02.009.16	H 160 mm.
Art. 02.009.17	H 180 mm.
Art. 02.009.18	H 250 mm.

Mart. a caldo / Hot hammered Ø 14 mm.	
Art. 02.009.26	H 100 mm.
Art. 02.009.27	H 110 mm.
Art. 02.009.28	H 115 mm.
Art. 02.009.29	H 120 mm.
Art. 02.009.30	H 125 mm.
Art. 02.009.31	H 130 mm.
Art. 02.009.32	H 135 mm.
Art. 02.009.33	H 140 mm.
Art. 02.009.34	H 160 mm.
Art. 02.009.35	H 180 mm.
Art. 02.009.36	H 250 mm.

Ø 16 mm.	
Art. 02.009.19	H 100 mm.
Art. 02.009.20	H 110 mm.
Art. 02.009.21	H 120 mm.
Art. 02.009.22	H 135 mm.
Art. 02.009.23	H 140 mm.
Art. 02.009.24	H 180 mm.
Art. 02.009.25	H 250 mm.

Mart. a caldo / Hot hammered Ø 16 mm.	
Art. 02.009.37	H 100 mm.
Art. 02.009.38	H 110 mm.
Art. 02.009.39	H 120 mm.
Art. 02.009.40	H 135 mm.
Art. 02.009.41	H 140 mm.
Art. 02.009.42	H 180 mm.
Art. 02.009.43	H 250 mm.



Cerchi con sezione in quadro  
Square section circles

□ 8 X 8 mm.	
Art. 02.010	H 100 mm.
Art. 02.011	H 120 mm.
Art. 02.012	H 130 mm.
Art. 02.012.01	H 90 mm.
Art. 02.012.02	H 105 mm.
Art. 02.012.03	H 110 mm.
Art. 02.012.04	H 135 mm.
Art. 02.012.05	H 180 mm.
Art. 02.012.06	H 250 mm.
Art. 02.012.07	H 270 mm.

□ 12 X 12 mm.	
Art. 02.016	H 100 mm.
Art. 02.017	H 120 mm.
Art. 02.018	H 130 mm.
Art. 02.018.01	H 110 mm.
Art. 02.018.02	H 135 mm.
Art. 02.018.03	H 140 mm.
Art. 02.018.04	H 180 mm.
Art. 02.018.05	H 210 mm.
Art. 02.018.06	H 250 mm.
Art. 02.018.07	H 275 mm.

□ 16 X 16 mm.	
Art. 02.018.19	H 100 mm.
Art. 02.018.20	H 110 mm.
Art. 02.018.21	H 120 mm.
Art. 02.018.22	H 135 mm.
Art. 02.018.23	H 140 mm.
Art. 02.018.24	H 180 mm.
Art. 02.018.25	H 250 mm.

□ 10 X 10 mm.	
Art. 02.013	H 100 mm.
Art. 02.014	H 120 mm.
Art. 02.015	H 130 mm.
Art. 02.015.01	H 90 mm.
Art. 02.015.02	H 110 mm.
Art. 02.015.03	H 135 mm.
Art. 02.015.04	H 140 mm.
Art. 02.015.05	H 180 mm.
Art. 02.015.06	H 250 mm.
Art. 02.015.07	H 270 mm.

□ 14 X 14 mm.	
Art. 02.018.08	H 100 mm.
Art. 02.018.09	H 110 mm.
Art. 02.018.10	H 115 mm.
Art. 02.018.11	H 120 mm.
Art. 02.018.12	H 125 mm.
Art. 02.018.13	H 130 mm.
Art. 02.018.14	H 135 mm.
Art. 02.018.15	H 140 mm.
Art. 02.018.16	H 160 mm.
Art. 02.018.17	H 180 mm.
Art. 02.018.18	H 250 mm.

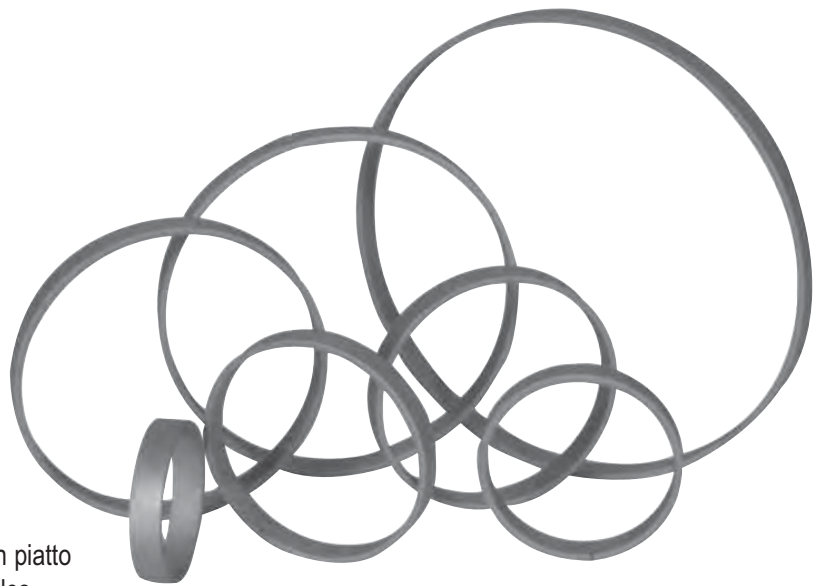

Cerchi con sezione in piatto  
Flat section circles

≠ 16 X 4 mm.	
Art. 02.019	H 100 mm.
Art. 02.020	H 120 mm.
Art. 02.021	H 130 mm.
Art. 02.022	H 160 mm.
Art. 02.023	H 190 mm.
Art. 02.024	H 250 mm.
Art. 02.024.01	H 110 mm.
Art. 02.024.02	H 125 mm.
Art. 02.024.03	H 175 mm.
Art. 02.024.04	H 200 mm.
Art. 02.024.05	H 300 mm.

≠ 30 X 4 mm.	
Art. 02.030.06	H 100 mm.
Art. 02.030.07	H 110 mm.
Art. 02.030.08	H 120 mm.
Art. 02.030.09	H 125 mm.
Art. 02.030.10	H 130 mm.
Art. 02.030.11	H 160 mm.
Art. 02.030.12	H 190 mm.
Art. 02.030.13	H 250 mm.

≠ 14 X 6 mm.	
Art. 02.036	H 100 mm.
Art. 02.037	H 120 mm.
Art. 02.038	H 130 mm.
Art. 02.039	H 160 mm.
Art. 02.040	H 190 mm.
Art. 02.041	H 250 mm.
Art. 02.041.01	H 80 mm.
Art. 02.041.02	H 90 mm.
Art. 02.041.03	H 105 mm.
Art. 02.041.04	H 110 mm.
Art. 02.041.05	H 115 mm.
Art. 02.041.06	H 125 mm.
Art. 02.041.07	H 128 mm.
Art. 02.041.08	H 150 mm.

≠ 16 X 8 mm.	
Art. 02.042	H 100 mm.
Art. 02.043	H 120 mm.
Art. 02.043.01	H 110 mm.
Art. 02.043.02	H 128 mm.
Art. 02.043.03	H 130 mm.
Art. 02.043.04	H 180 mm.

≠ 20 X 4 mm.	
Art. 02.025	H 100 mm.
Art. 02.026	H 120 mm.
Art. 02.027	H 130 mm.
Art. 02.028	H 160 mm.
Art. 02.029	H 190 mm.
Art. 02.030	H 250 mm.
Art. 02.030.01	H 110 mm.
Art. 02.030.02	H 125 mm.
Art. 02.030.03	H 175 mm.
Art. 02.030.04	H 200 mm.
Art. 02.030.05	H 300 mm.

≠ 12 X 6 mm.	
Art. 02.031	H 100 mm.
Art. 02.032	H 120 mm.
Art. 02.033	H 130 mm.
Art. 02.034	H 160 mm.
Art. 02.035	H 190 mm.
Art. 02.035.01	H 80 mm.
Art. 02.035.02	H 90 mm.
Art. 02.035.03	H 105 mm.
Art. 02.035.04	H 110 mm.
Art. 02.035.05	H 115 mm.
Art. 02.035.06	H 125 mm.
Art. 02.035.07	H 128 mm.
Art. 02.035.08	H 150 mm.
Art. 02.035.09	H 250 mm.

≠ 20 X 6 mm.	
Art. 02.041.09	H 80 mm.
Art. 02.041.10	H 90 mm.
Art. 02.041.11	H 100 mm.
Art. 02.041.12	H 105 mm.
Art. 02.041.13	H 110 mm.
Art. 02.041.14	H 115 mm.
Art. 02.041.15	H 120 mm.
Art. 02.041.16	H 125 mm.
Art. 02.041.17	H 128 mm.
Art. 02.041.18	H 130 mm.
Art. 02.041.19	H 150 mm.
Art. 02.041.20	H 160 mm.
Art. 02.041.21	H 190 mm.
Art. 02.041.22	H 250 mm.

≠ 16 X 6 mm.	
Art. 02.043.29	H 80 mm.
Art. 02.043.30	H 90 mm.
Art. 02.043.31	H 100 mm.
Art. 02.043.32	H 105 mm.
Art. 02.043.33	H 110 mm.
Art. 02.043.34	H 115 mm.
Art. 02.043.35	H 120 mm.
Art. 02.043.36	H 125 mm.
Art. 02.043.37	H 128 mm.
Art. 02.043.38	H 130 mm.
Art. 02.043.39	H 150 mm.
Art. 02.043.40	H 160 mm.
Art. 02.043.41	H 190 mm.
Art. 02.043.42	H 250 mm.





Cerchio aperto sezione in piatto  
Open circle flat section

$\neq 12 \times 6$ mm.		$\neq 20 \times 6$ mm.	
Art. 02.043.05	H 100 mm.	Art. 02.043.15	H 100 mm.
Art. 02.043.06	H 110 mm.	Art. 02.043.16	H 110 mm.
Art. 02.043.07	H 120 mm.	Art. 02.043.17	H 120 mm.
Art. 02.043.08	H 130 mm.	Art. 02.043.18	H 130 mm.
Art. 02.043.09	H 150 mm.	Art. 02.043.19	H 150 mm.
$\neq 14 \times 6$ mm.		$\neq 16 \times 8$ mm.	
Art. 02.043.10	H 100 mm.	Art. 02.043.20	H 100 mm.
Art. 02.043.11	H 110 mm.	Art. 02.043.21	H 110 mm.
Art. 02.043.12	H 120 mm.	Art. 02.043.22	H 120 mm.
Art. 02.043.13	H 130 mm.	Art. 02.043.23	H 130 mm.
Art. 02.043.14	H 150 mm.	$\neq 16 \times 6$ mm.	
		Art. 02.043.43	H 100 mm.
		Art. 02.043.44	H 110 mm.
		Art. 02.043.45	H 120 mm.
		Art. 02.043.46	H 130 mm.
		Art. 02.043.47	H 150 mm.



Cerchio aperto sez. in quadro  
Open circle square section

$\square 12 \times 12$ mm.	
Art. 02.043.24	H 100 mm.
Art. 02.043.25	H 110 mm.
Art. 02.043.26	H 120 mm.
Art. 02.043.27	H 130 mm.
Art. 02.043.28	H 180 mm.

Estremità battute e rastremate a caldo  
*Heat forged and tapered ends*

H 100 mm	$\neq 12 \times 6$ mm
Art. 02.043.100	

H.200 X L.125 mm.
Art. 02.044 $\neq 12 \times 6$

H.160 X L.100 mm.
Art. 02.045 $\neq 16 \times 8$
Art. 02.045.01 $\neq 12 \times 6$
Art. 02.045.02 $\neq 14 \times 6$

H.140 X L.100 mm.
Art. 02.046 $\neq 16 \times 8$

H.190 X L.130 mm.
Art. 02.047 $\neq 20 \times 4$

H.160 X L.120 mm.
Art. 02.048 $\neq 16 \times 8$

Ovale Piatto Modello Scala <i>Scala Model Flat Oval</i>
H.160 X L.100 mm.
Art. 02.048.01 $\neq 12 \times 6$
Art. 02.048.02 $\neq 14 \times 6$
Art. 02.048.03 $\neq 16 \times 6$



H.240 X L.170 mm.
Art. 02.049 $\square 14 \times 14$



H.160 X L.115 mm.
Art. 02.050 $\square 12 \times 12$





NEW



NEW



H.100 X L.100 mm.  
Art. 02.050.50 ≙ 14 x 6

H.110 X L.110 mm.  
Art. 02.050.51 ≙ 12 x 6

H.110 X L.110 mm.  
Art. 02.050.55 ≙ 12 x 6

H.200 X L.200 mm.  
Art. 02.051 □ 8 X 8  
Art. 02.052 □ 10 X 10  
Art. 02.053 □ 12 X 12

H.80 X L.80 mm.  
Art. 02.050.54 ≙ 12 x 6

NEW



H.220 X L.220 mm.  
Art. 02.050.56 ≙ 12 x 6

NEW

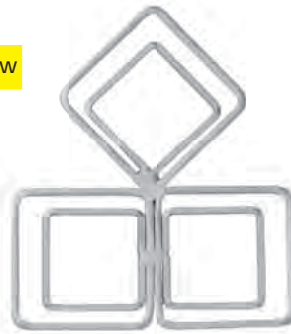

H.250 X L.220 mm.  
Art. 02.050.60 ≙ 12 x 6



H.270 X L.190 mm.  
Art. 02.054 □ 14 X 14



H.165 X L.120 mm.  
Art. 02.055 □ 12 X 12



H.250 X L.175 mm.  
Art. 02.056 □ 14 X 14



Mod. Scala / Scala Model  
H.235 X L.125 mm.  
Art. 02.057 ≙ 12 X 6  
Art. 02.058 ≙ 14 X 6



H.250  
Art. 02.059 ≙ 12 X 6  
Art. 02.060 ≙ 14 X 6  
Art. 02.061 ≙ 20 X 5



Mod. Scala / Scala Model  
H.300 X L.110 mm.  
Art. 02.062 ≙ 12 X 6  
Art. 02.063 ≙ 14 X 6

Estremità battute e rastremate a caldo  
Heat forged and tapered ends



H.50 X L.50 mm.  
Art. 02.063.01 □ 4 X 4 - 6 Traf. / Elem.  
Art. 02.063.02 □ 4 X 4 - 4 Traf. / Elem.



H.70 X L.70 mm.  
Art. 02.063.03 □ 6 X 6 - 6 Traf. / Elem.  
Art. 02.063.04 □ 6 X 6 - 4 Traf. / Elem.



H.70 X L.70 mm.  
Art. 02.063.05 Ø 6 - 6 Traf. / Elem.

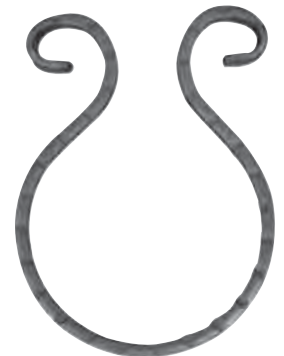

Mod. Scala / Scala Model  
H.160 X L.110 mm.  
Art. 02.064 ≙ 12 X 6  
Art. 02.065 ≙ 14 X 6

Tutte le parti di questo catalogo - foto comprese - sono di proprietà Euro-Fer. La riproduzione, anche parziale, è vietata in ogni forma e con ogni mezzo. / Every part of this catalogue - photos included - is Euro-Fer's property. All forms of copying are strictly prohibited.



Piatto Modello Scala  
Flat Scala Model

Foro Ø 14 mm  
Hole Ø 14 mm

Tondo Lavorato  
Worked Round Bar

≠ 12 X 6 mm.  
Art. 02.065.01 H 100 mm.  
Art. 02.065.02 H 120 mm

≠ 12 X 6 mm.  
Art. 02.065.07 H 100 mm.  
Art. 02.065.08 H 120 mm

Ø 14 mm.  
Art. 02.065.13 H 110 mm.  
Art. 02.065.14 H 125 mm

Ø 14 mm.  
Art. 02.065.15 H 100 mm.  
Art. 02.065.16 H 110 mm.  
Art. 02.065.17 H 120 mm.

≠ 14 X 6 mm.  
Art. 02.065.03 H 100 mm.  
Art. 02.065.04 H 120 mm.

≠ 14 X 6 mm.  
Art. 02.065.09 H 100 mm.  
Art. 02.065.10 H 120 mm.

≠ 16 X 6 mm.  
Art. 02.065.05 H 100 mm.  
Art. 02.065.06 H 120 mm.

≠ 16 X 6 mm.  
Art. 02.065.11 H 100 mm.  
Art. 02.065.12 H 120 mm.

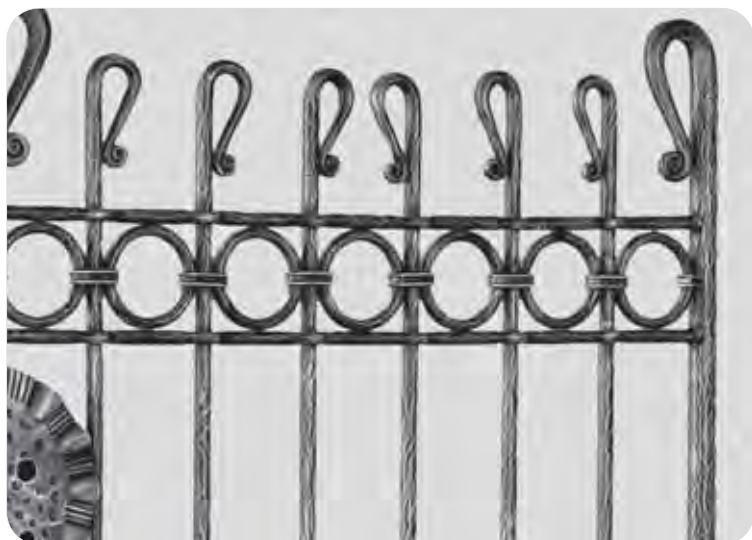





Piatto Modello Scala  
Flat Scala Model



Piatto Modello Scala  
Flat Scala Model



Martellato  
Hammered

≠ 12 X 6 mm.

Art. 02.066	H 100 mm.
Art. 02.066.01	H 110 mm.
Art. 02.067	H 120 mm.
Art. 02.068	H 130 mm.
Art. 02.068.01	H 150 mm.

≠ 14 X 6 mm.

Art. 02.069	H 100 mm.
Art. 02.069.01	H 110 mm.
Art. 02.070	H 120 mm.
Art. 02.071	H 130 mm.
Art. 02.071.01	H 150 mm.

≠ 20 X 6 mm.

Art. 02.071.02	H 100 mm.
Art. 02.071.03	H 110 mm.
Art. 02.071.04	H 120 mm.
Art. 02.071.05	H 130 mm.
Art. 02.071.06	H 150 mm.

≠ 12 X 6 mm.

Art. 02.072	H 100 mm.
Art. 02.073	H 120 mm.
Art. 02.074	H 130 mm.
Art. 02.074.01	H 80 mm.
Art. 02.074.02	H 90 mm.
Art. 02.074.03	H 105 mm.
Art. 02.074.04	H 110 mm.
Art. 02.074.05	H 115 mm.
Art. 02.074.06	H 125 mm.
Art. 02.074.07	H 150 mm.
Art. 02.074.08	H 250 mm.

≠ 14 X 6 mm.

Art. 02.075	H 100 mm.
Art. 02.076	H 120 mm.
Art. 02.077	H 130 mm.
Art. 02.077.01	H 80 mm.
Art. 02.077.02	H 90 mm.
Art. 02.077.03	H 105 mm.
Art. 02.077.04	H 110 mm.
Art. 02.077.05	H 115 mm.
Art. 02.077.06	H 125 mm.
Art. 02.077.07	H 150 mm.
Art. 02.077.08	H 250 mm.

≠ 20 X 6 mm.

Art. 02.077.09	H 80 mm.
Art. 02.077.10	H 90 mm.
Art. 02.077.11	H 100 mm.
Art. 02.077.12	H 105 mm.
Art. 02.077.13	H 110 mm.
Art. 02.077.14	H 115 mm.
Art. 02.077.15	H 120 mm.
Art. 02.077.16	H 125 mm.
Art. 02.077.17	H 130 mm.
Art. 02.077.18	H 150 mm.
Art. 02.077.19	H 160 mm.
Art. 02.077.20	H 190 mm.
Art. 02.077.21	H 250 mm.

≠ 16 x 6 mm.

Art. 02.074.17	H 100 mm.
Art. 02.074.18	H 110 mm.
Art. 02.074.20	H 120 mm.

□ 12 X 12 mm.

Art. 02.077.22	H 100 mm.
Art. 02.077.23	H 110 mm.
Art. 02.077.24	H 120 mm.
Art. 02.077.25	H 180 mm.

Mart. a caldo / Hot hammered  
□ 14 X 14 mm.

Art. 02.077.26	H 100 mm.
Art. 02.077.27	H 110 mm.
Art. 02.077.28	H 115 mm.
Art. 02.077.29	H 120 mm.
Art. 02.077.30	H 125 mm.
Art. 02.077.31	H 130 mm.
Art. 02.077.32	H 135 mm.
Art. 02.077.33	H 140 mm.
Art. 02.077.34	H 160 mm.
Art. 02.077.35	H 180 mm.
Art. 02.077.36	H 250 mm.

Mart. a caldo / Hot hammered  
□ 16 X 16 mm.

Art. 02.077.37	H 100 mm.
Art. 02.077.38	H 110 mm.
Art. 02.077.39	H 120 mm.
Art. 02.077.40	H 135 mm.
Art. 02.077.41	H 140 mm.
Art. 02.077.42	H 180 mm.
Art. 02.077.43	H 250 mm.



## Pigne a 4 Trafilati / 4 - Element Crowns



H.90 X L.35 mm.  
Art. 02.078 □ 8 X 8



H.110 X L.45 mm.  
Art. 02.079 □ 10 X 10



H.150 X L.65 mm.  
Art. 02.080 □ 12 X 12



Liscio / Smooth  
4 Trafilati / Elements  
Art. 02.080.ES  
H. 125 x L.57 mm □ 12 x 12  
Art. 02.081.ES  
H. 135 x L.60 mm □ 14 x 14  
Art. 02.082.ES  
H. 150 x L.70 mm □ 16 x 16



H.160 X L.70 mm.  
Art. 02.081 □ 14 X 14



H.160 X L.70 mm.  
Art. 02.082 □ 16 X 16



H.210 X L.90 mm.  
Art. 02.083 □ 20 X 20



H.210 X L.110 mm.  
Art. 02.084 □ 24 X 24  
Martellato / Hammered  
Art. 02.084.01 □ 24 X 24



H.240 X L.115 mm.  
Art. 02.085 □ 30 X 30



4 Quadri da 6 mm  
4 Six mm Squares



H.150 X L.50 mm.  
Art. 02.089 □ 12 X 12



4 Tondini da 6 mm  
4 Six mm Rounds



H.150 X L.50 mm.  
Art. 02.090 Ø 12



4 Tondini da 6 mm  
4 Six mm Rounds



H.150 X L.60 mm.  
Art. 02.091 Ø 12



Art. 02.100 H.195 X L.50 mm. □ 12 X 12  
Art. 02.100.01 H.200 X L.60 mm. □ 14 X 14  
Art. 02.100.02 H.200 X L.65 mm. □ 16 X 16  
Art. 02.100.03 H.195 X L.50 mm. Ø 12  
A 9 trafilati / 9 - Element Crowns  
Art. 02.100.04 H.195 X L.50 mm. □ 12 X 12



H.100 X L.100 mm.  
Art. 02.130  
≠ 14 X 6  
□ 4 X 4



H.160 X L.105 mm.  
Art. 02.140  
≠ 14 X 6  
□ 6 X 6



Pigne a 9 Trafilati / 9 - Element Crowns

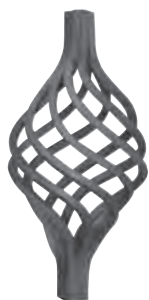

H.155 X L.75 mm.  
Art. 02.086 □ 12 X 12

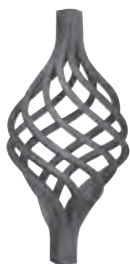

H.125 X L.65 mm.  
Art. 02.086.01 □ 12 X 12



H.190 X L.105 mm.  
Art. 02.087 □ 24 X 24

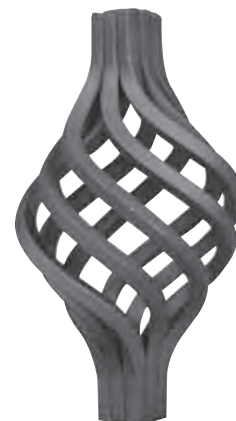

H.245 X L.130 mm.  
Art. 02.088 □ 30 X 30



Liscio / Smooth  
H. 190 x L.120 mm  
Art. 02.200 □ 16 mm  
Art. 02.200.01 □ 20 mm



Liscio / Smooth  
H. 380 x L.120 mm  
Art. 02.201 □ 16 mm



Liscio / Smooth  
H. 235 x L.120 mm  
Art. 02.202 □ 16 mm



Liscio / Smooth  
H. 155 x L.135 mm  
Art. 02.203 □ 16 mm  
Art. 02.203.01 □ 20 mm



Liscio / Smooth  
H. 470 x L.120 mm  
Art. 02.204 □ 16 mm



Liscio / Smooth  
H. 185 x L.155 mm  
Art. 02.205 □ 16 mm



Liscio / Smooth  
H. 195 x L.165 mm  
Art. 02.206 □ 16 mm



Liscio / Smooth  
H. 240 x L.135 mm  
Art. 02.207 □ 16 mm



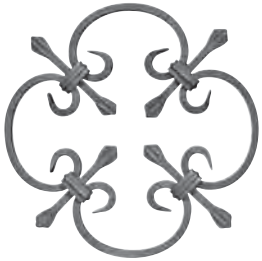

H.250 x L.250 mm  
Modello Scala / Scala Model  
Art. 03.001 □ 8 x 8  
Liscio / Smooth  
Art. 03.001.01 □ 8 x 8

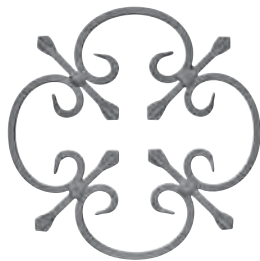

H.250 x L.250 mm  
Modello Scala / Scala Model  
Art. 03.002 □ 8 x 8  
Liscio / Smooth  
Art. 03.002.01 □ 8 x 8

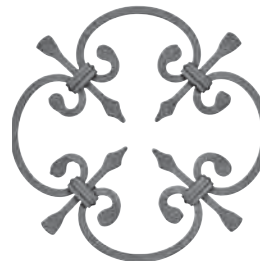

Mod. Scala / Scala Model  
H.250 X L.250 mm.  
Art. 03.003 □ 8 X 8



Mod. Scala / Scala Model  
H.250 X L.250 mm.  
Art. 03.004 □ 8 X 8



Mod. Scala / Scala Model  
H.250 X L.250 mm.  
Art. 03.005 ≧ 20 X 4



Mod. Scala / Scala Model  
H.250 X L.250 mm.  
Art. 03.006 ≧ 20 X 4

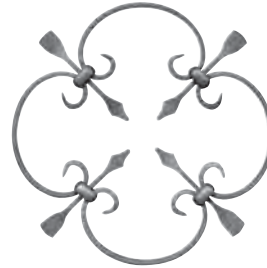

Mod. Scala / Scala Model  
H.250 X L.250 mm.  
Art. 03.007 ≧ 10 X 5

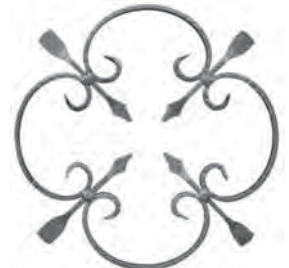

Mod. Scala / Scala Model  
H.250 X L.250 mm.  
Art. 03.008 ≧ 10 X 5

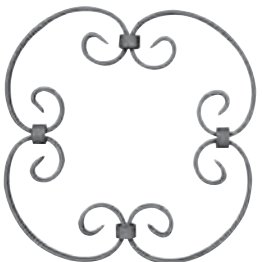

Liscio / Smooth  
H.250 X L.250 mm.  
Art. 03.009 ≧ 16 X 4

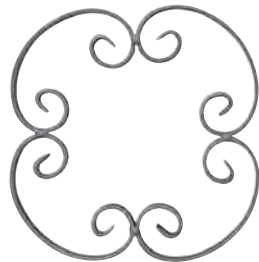

Liscio / Smooth  
H.250 X L.250 mm.  
Art. 03.010 ≧ 16 X 4

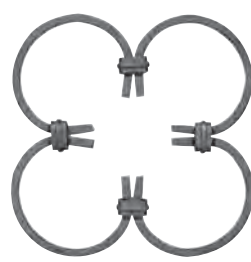

Liscio / Smooth  
H.250 X L.250 mm.  
Art. 03.011 □ 8 X 8



Liscio / Smooth  
H.250 X L.250 mm.  
Art. 03.012 □ 8 X 8





H.250 X L.250 mm.  
Art. 03.013 □ 8 X 8



Mod. Scala / Scala Model  
H.250 X L.250 mm.  
Art. 03.014 □ 8 X 8

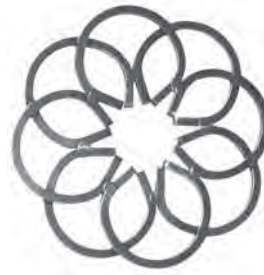

Liscio / Smooth  
H.250 x L.250 mm  
Art. 03.014.01 □ 8  
Art. 03.014.02 Ø 8



Liscio / Smooth  
H.250 x L.250 mm  
Art. 03.014.03 ≙ 12 x 4



Liscio / Smooth  
H.250 x L.250 mm  
Art. 03.014.04 ≙ 12 x 4

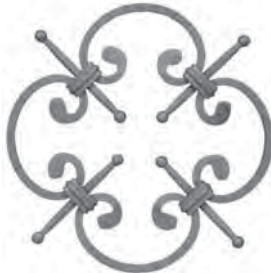

Mod. Scala / Scala Model  
H.250 X L.250 mm.  
Art. 03.015 □ 8 X 8



Mod. Scala / Scala Model  
H.250 X L.250 mm.  
Art. 03.016 □ 8 X 8

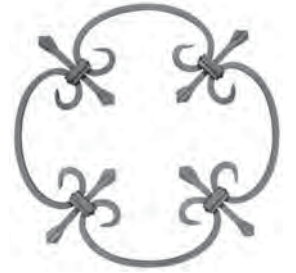

Mod. Scala / Scala Model  
H.300 X L.300 mm.  
Art. 03.017 □ 8 X 8



Mod. Scala / Scala Model  
H.300 X L.300 mm.  
Art. 03.018 □ 8 X 8

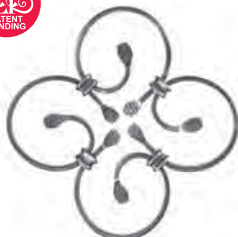

Liscio / Smooth  
H.250 X L.250 mm.  
Art. 03.018.01 ≙ 12 X 6

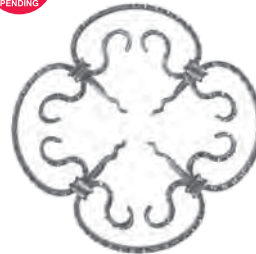

Mod. Scala / Scala Model  
H.270 X L.270 mm.  
Art. 03.018.03 ≙ 14 X 6

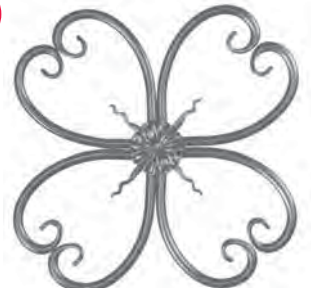

⊗ Tondo / Round  
H.380 X L.380 mm.  
Art. 03.018.04 Ø 12

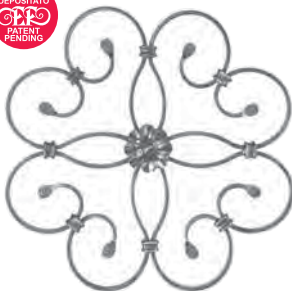

⊗ Liscio / Smooth  
H.360 X L.360 mm.  
Art. 03.018.05 ≙ 12 X 6  
Art. 03.018.16 ≙ 14 X 6



Liscio / Smooth  
H.370 X L.370 mm.  
Art. 03.018.06 ≙ 12 X 6  
Art. 03.018.17 ≙ 14 X 6



Tutte le parti di questo catalogo - foto comprese - sono di proprietà Euro-Fer. La riproduzione, anche parziale, è vietata in ogni forma e con ogni mezzo. / Every part of this catalogue - photos included - is Euro-Fer's property. All forms of copying are strictly prohibited.

🌀 fiori da entrambi i lati / flowers on both sides



🌀 Mod. Scala / Scala Model

H.445 X L.445 mm.

Art. 03.018.07 ≙ 14 X 6

Art. 03.018.18 ≙ 16 X 6

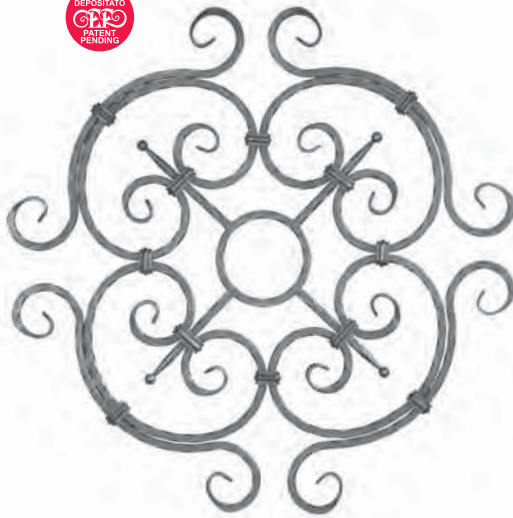

🌀 Martellato / Hammered

H.710 X L.710 mm.

Art. 03.018.08 □ 12 X 12



🌀 Modello Scala / Scala Model

H.760 x L.760 mm.

Art. 03.018.09 ≙ 14 x 6

Art. 03.018.19 ≙ 16 x 6



🌀 Martellato / Hammered

H.780 X L.780 mm.

Art. 03.018.10 □ 12 X 12

Art. 03.018.11 □ 14 X 14

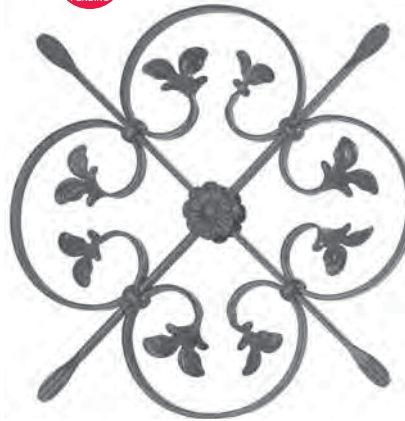

🌀 Liscio / Smooth

H.545 X L.545 mm.

Art. 03.018.12 ≙ 12 X 6

🌀 Liscio / Smooth

H.530 X L.530 mm.

Art. 03.018.13 Ø 10

Art. 03.018.20 Ø 12

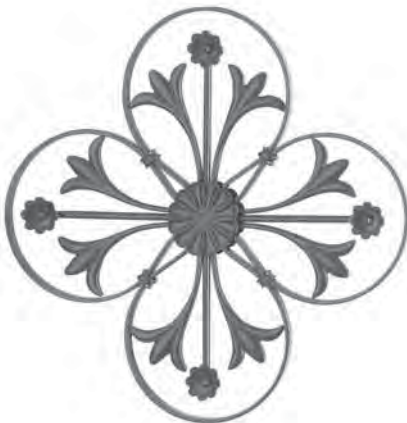

🌀 Liscio / Smooth

H.545 X L.545 mm.

Art. 03.018.14

≙ 12 X 6

Ø 10

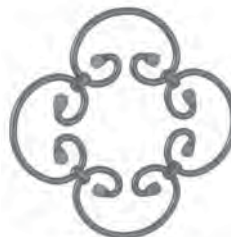

Liscio / Smooth

H.250 X L.250 mm.

Art. 03.018.15 Ø 8

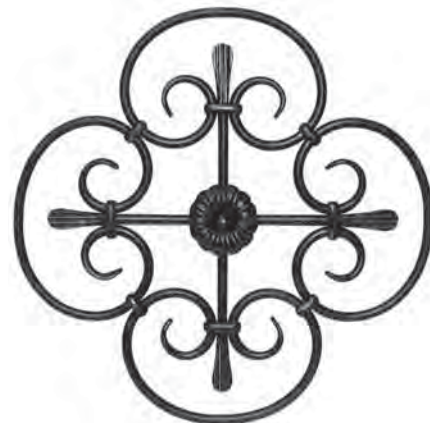

🌀 Liscio / Smooth

H.565 x L.565 mm

Art. 03.018.21 Ø 14 mm



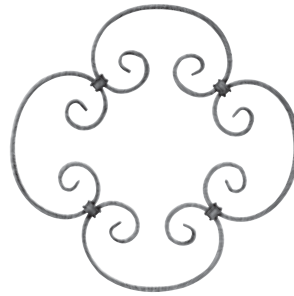
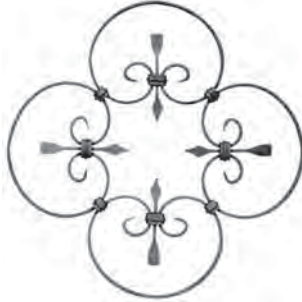
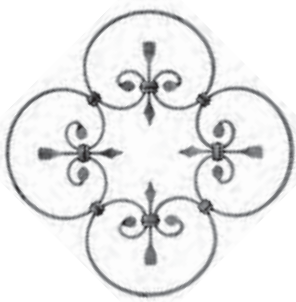
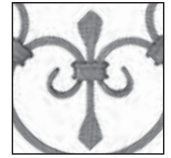

Mod. Scala / Scala Model  
H.380 X L.380 mm.  
Art. 03.019 ≙ 10 X 5

Mod. Scala / Scala Model  
H.380 X L.380 mm.  
Art. 03.020 ≙ 10 X 5

Mod. Scala / Scala Model  
H.370 X L.370 mm.  
Art. 03.021 ≙ 12 X 6

Rigato / Fluted  
H.300 X L.300 mm.  
Art. 03.022 ≙ 12 X 6

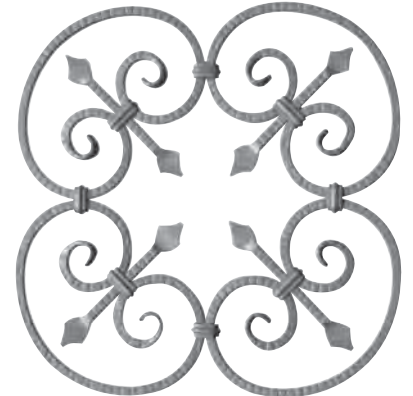
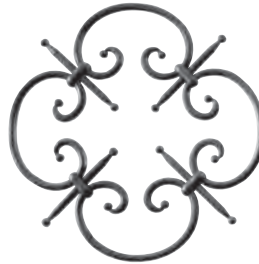

Rigato / Fluted  
H.140 X L.205 mm.  
Art. 03.023 ≙ 12 X 6

Mod. Scala / Scala Model  
H.155 X L.155 mm.  
Art. 03.024 □ 6 X 6

Liscio / Smooth  
H.330 X L.330 mm.  
Art. 03.024.01 Ø 10

Mod. Mattone / Brick Model  
H.590 X L.590 mm.  
Art. 03.025 □ 12 X 12  
Art. 03.025.02 □ 14 X 14

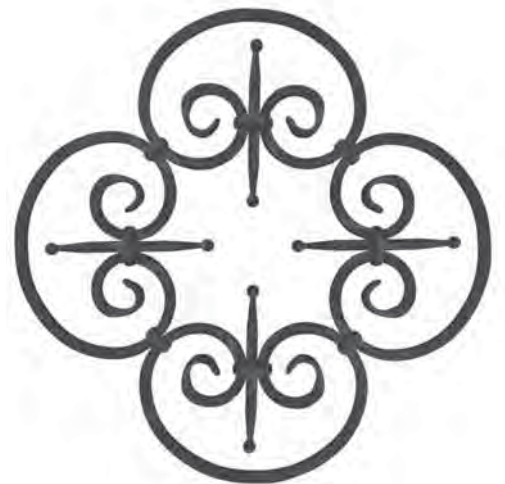
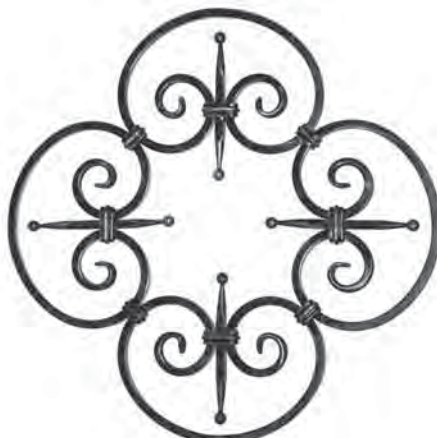
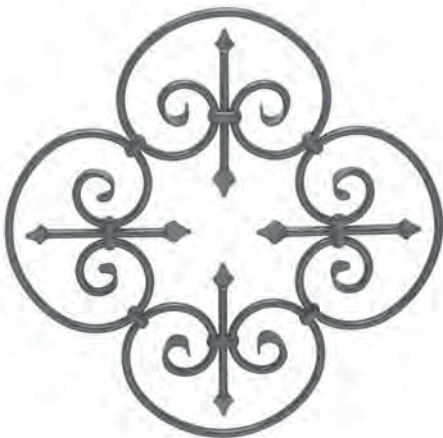

Liscio / Smooth  
H.580 X L.580 mm.  
Art. 03.025.01 Ø 12  
Art. 03.025.03 Ø 14

Liscio / Smooth  
H.580 x L.580 mm  
Art. 03.025.04 □ 12 mm ;  
Art. 03.025.05 □ 14 mm

Liscio / Smooth  
H.625 x L. 625  
Art. 03.025.10 □ 14x14 mm



 fiori da entrambi i lati / flowers on both sides

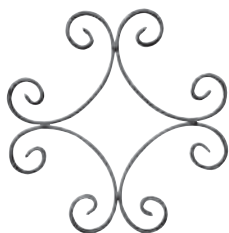

Liscio / Smooth  
H.240 X L.240 mm.  
Art. 03.026  $\approx$  16 X 4

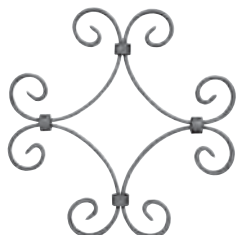

Liscio / Smooth  
H.240 X L.240 mm.  
Art. 03.027  $\approx$  16 X 4

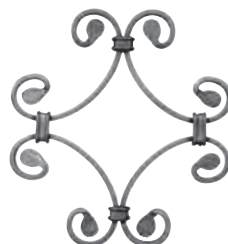

Liscio / Smooth  
H.240 X L.240 mm.  
Art. 03.028  $\approx$  12 X 6

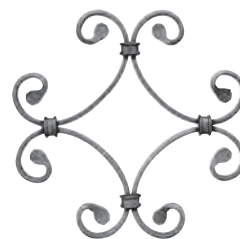

Liscio / Smooth  
H.240 X L.240 mm.  
Art. 03.029  $\approx$  12 X 6

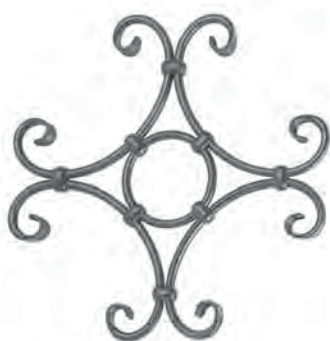

Liscio / Smooth  
H.360 X L.360 mm.  
Art. 03.029.01  $\varnothing$  10  
Art. 03.029.03  $\varnothing$  12  
Art. 03.029.04  $\varnothing$  14

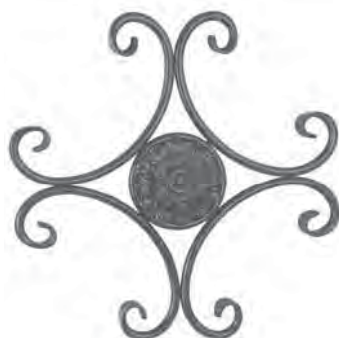

 Liscio / Smooth  
H.360 X L.360 mm.  
Art. 03.029.02  $\varnothing$  10  
Art. 03.029.05  $\varnothing$  12  
Art. 03.029.06  $\varnothing$  14



Liscio / Smooth  
H.250 X L.250 mm.  
Art. 03.030  $\approx$  16 X 4

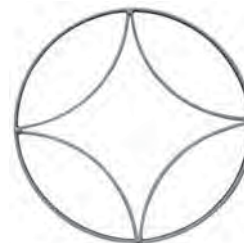

Liscio / Smooth  
H.250 X L.250 mm.  
Art. 03.031  $\approx$  16 X 4



Mod. Scala / Scala Model  
H.270 X L.270 mm.  
Art. 03.031.01  $\approx$  12 X 6  
Art. 03.031.07  $\approx$  14 X 6



Liscio / Smooth  
H.220 X L.220 mm.  
Art. 03.031.02  $\approx$  12 X 6  
Art. 03.031.08  $\approx$  14 X 6

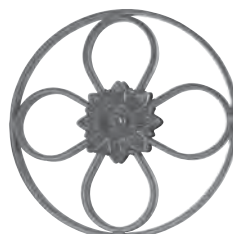

 Liscio / Smooth  
H.250 X L.250 mm.  
Art. 03.031.03  $\approx$  12 X 6  
Art. 03.031.09  $\approx$  14 X 6



 Liscio / Smooth  
H.250 X L.250 mm.  
Art. 03.031.04  $\approx$  12 X 6



 Liscio / Smooth  
H.250 X L.250 mm.  
Art. 03.031.05  $\varnothing$  10



 Liscio / Smooth  
H.250 X L.250 mm.  
Art. 03.031.06  $\varnothing$  10



Liscio / Smooth  
H.250 X L.250 mm.  
Art. 03.032  $\approx$  16 X 4



Liscio / Smooth  
H.250 X L.250 mm.  
Art. 03.033  $\approx$  16 X 4

🌀 fiori da entrambi i lati / flowers on both sides

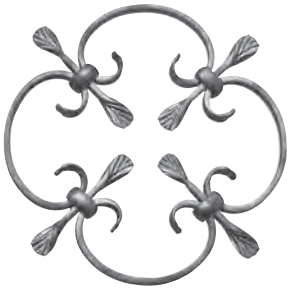

Liscio / Smooth  
H.350 X L.350 mm.  
Art. 03.033.01 ≙ 12 X 6  
H.250 X L.250 mm.  
Art. 03.033.02 ≙ 12 X 6



Liscio / Smooth  
H.250 X L.250 mm.  
Art. 03.034 ≙ 12 X 6



Liscio / Smooth  
H.260 X L.260 mm.  
Art. 03.034.01 ≙ 12 X 6

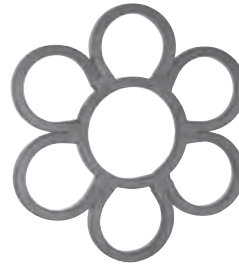

Liscio / Smooth  
H.300 X L.300 mm.  
Art. 03.034.10 □ 12 X 12

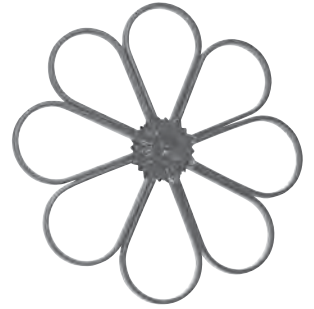

🌀 Liscio / Smooth  
H.380 X L.380 mm.  
Art. 03.034.12 ≙ 12 X 6



Liscio / Smooth  
H.530 X L.530 mm.  
Art. 03.034.21 ≙ 12 X 6



🌀 Liscio / Smooth  
H.470 X L.470 mm.  
Art. 03.034.22 Ø 10  
Art. 03.034.29 Ø 12  
Art. 03.034.30 Ø 14  
Art. 03.034.31 Ø 16



🌀 Martellato / Hammered  
H.520 X L.420 mm.  
Art. 03.034.23 □ 12 X 12  
Art. 03.034.32 □ 14 X 14  
Liscio / Smooth  
H.520 x L.420 mm  
Art. 03.034.41 □ 12 X 12  
Art. 03.034.42 Ø 12  
Art. 03.034.43 Ø 14

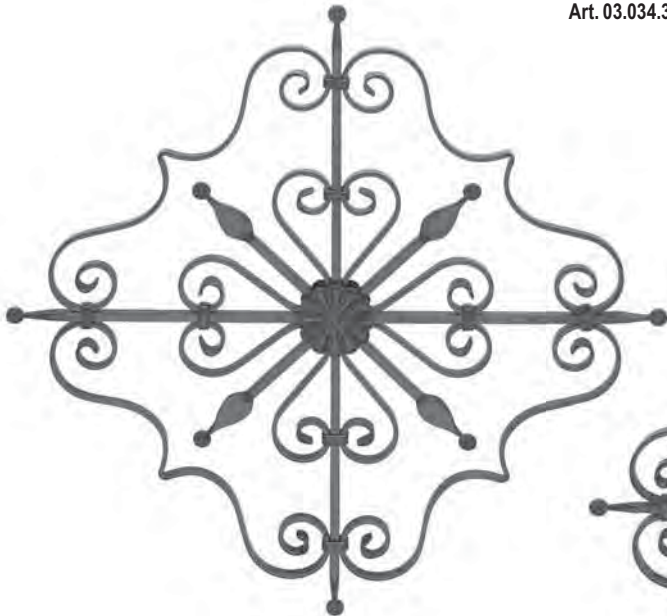

🌀 Liscio / Smooth  
H.830 X L.830 mm.  
Art. 03.034.24 ≙ 12 X 6  
□ 12 X 12  
Art. 03.034.33 ≙ 14 X 6  
□ 14 X 14

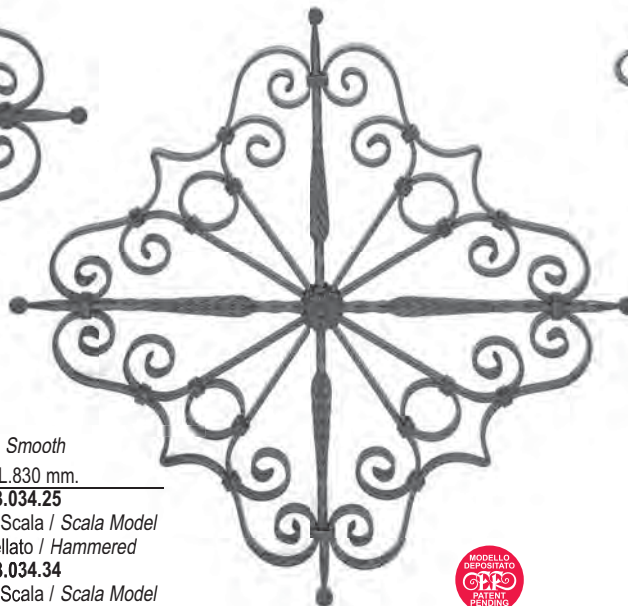

🌀 Liscio / Smooth  
H.830 X L.830 mm.  
Art. 03.034.25 ≙ 12 X 6 Mod. Scala / Scala Model  
□ 12 X 12 Martellato / Hammered  
Art. 03.034.34 ≙ 14 X 6 Mod. Scala / Scala Model  
□ 14 X 14 Martellato / Hammered

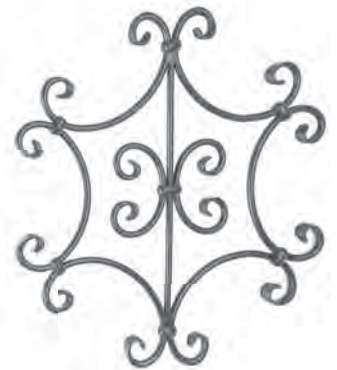

Liscio / Smooth  
H.500 X L.500 mm.  
Art. 03.034.26 Ø 12  
Art. 03.034.27 Ø 14  
Art. 03.034.28 Ø 16



Tutte le parti di questo catalogo - foto comprese - sono di proprietà Euro-Fer. La riproduzione, anche parziale, è vietata in ogni forma e con ogni mezzo. / Every part of this catalogue - photos included - is Euro-Fer's property. All forms of copying are strictly prohibited.

🌀 fiori da entrambi i lati / flowers on both sides

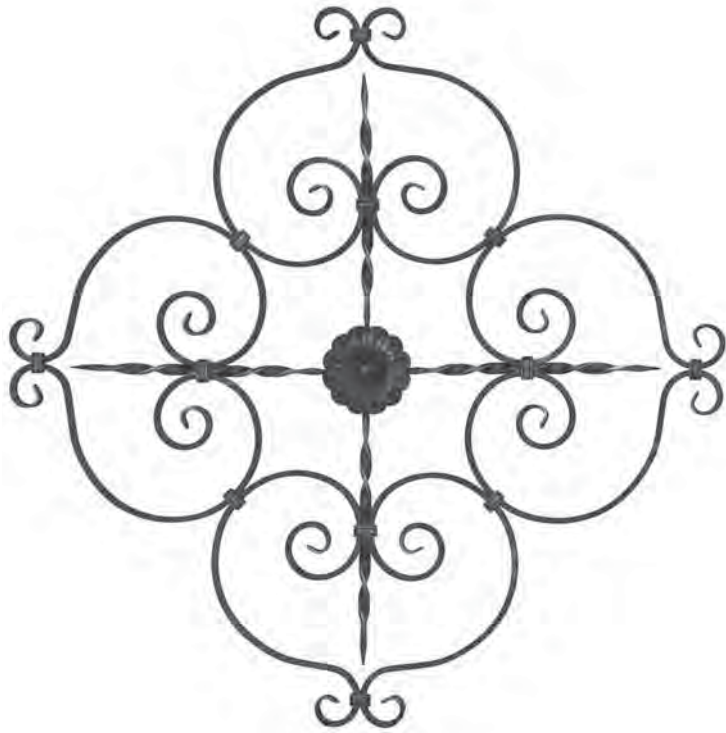

🌀 Liscio / Smooth  
H.970 x L.970 mm  
Art. 03.034.35  $\neq$  16 x 8

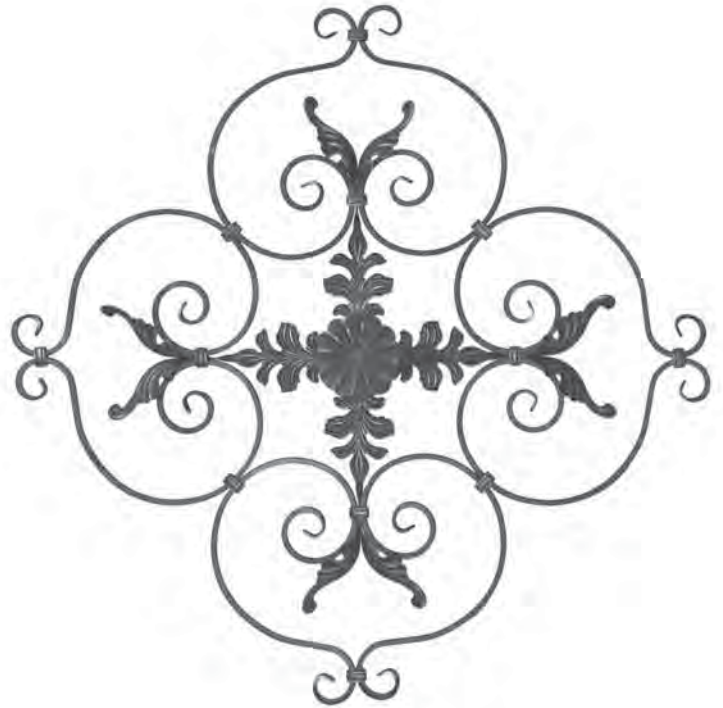

🌀 Liscio / Smooth  
H.970 x L.970 mm  
Art. 03.034.36  $\neq$  16 x 8



Liscio / Smooth  
L.200 x H.200 mm  
Art. 03.034.38  $\neq$  12 x 6

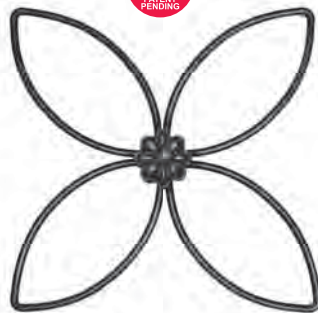

🌀 Liscio / Smooth  
L.315 x H.315 mm  
Art. 03.034.39  $\varnothing$  8



🌀 Martellato / Hammered  
H.950 x L.430 mm  
Art. 03.034.40  $\square$  12  
Fiori su ambo i lati  
Flowers on both sides



Art. 03.034.50  
Art. 03.034.51

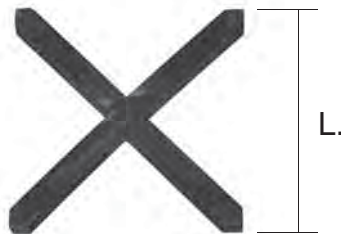

Liscio / Smooth  
Art. 03.034.60  $\square$  12 L.100 x H.100 mm  
Art. 03.034.61  $\square$  12 L.110 x H.110 mm  
Art. 03.034.62  $\square$  12 L.125 x H.125 mm  
Art. 03.034.63  $\square$  12 L.108 x H.108 mm





Modello Scala / *Scala Model*  
H.155 X L.180 mm.  
Art. 03.035 ≙ 10 X 5



Modello Scala / *Scala Model*  
H.180 X L.130 mm.  
Art. 03.035.01 ≙ 10 X 5



Modello Scala / *Scala Model*  
H.155 X L.180 mm.  
Art. 03.036 ≙ 10 X 5

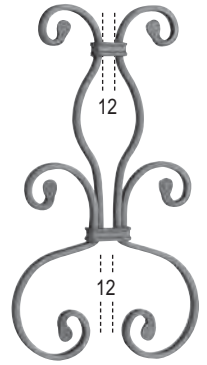

H.350 X L.190 mm.  
Art. 03.036.01 ≙ 12 X 6



H.110 X L.125 mm.  
Art. 03.036.02 ∅ 8



H.125 X L.115 mm.  
Art. 03.037 ≙ 12 X 6  
Art. 03.038 □ 8 X 8

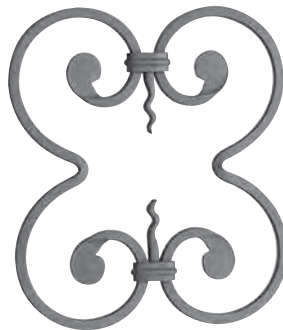

H.240 X L.210 mm.  
Art. 03.038.01 □ 8 X 8



H.215 X L.155 mm.  
Art. 03.039 ≙ 12 X 6

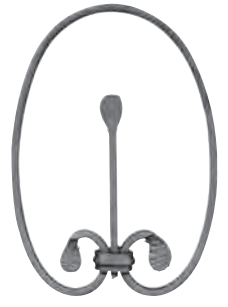

H.215 X L.155 mm.  
Art. 03.040 ≙ 12 X 6



H.215 X L.165 mm.  
Art. 03.041 ≙ 12 X 6



H.380 X L.185 mm.  
Art. 03.042 ≙ 12 X 6

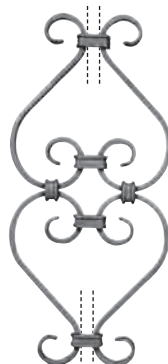

H.360 X L.165 mm.  
Art. 03.043 ≙ 12 X 6

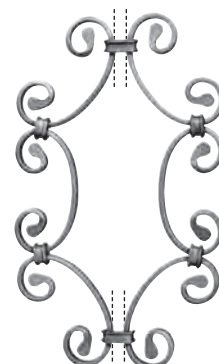

H.380 X L.230 mm.  
Art. 03.044 ≙ 12 X 6

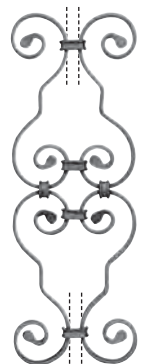

H.480 X L.170 mm.  
Art. 03.045 ≙ 12 X 6



H.440 X L.225 mm.  
Art. 03.046 ≙ 12 X 6



H.410 X L.200 mm.  
Art. 03.047 ≙ 12 X 6



H.450 X L.205 mm.  
Art. 03.048 ≙ 12 X 6



H.330 X L.180 mm.  
Art. 03.049 ≙ 12 X 6

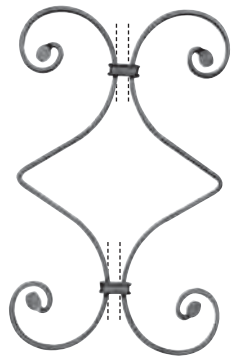

H.385 X L.230 mm.  
Art. 03.050 ≙ 12 X 6

🌀 fiori da entrambi i lati / flowers on both sides

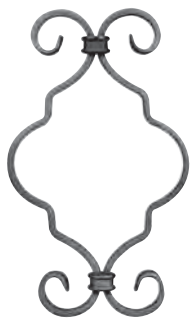

H.250 X L.160 mm.  
Art. 03.051 ≙ 12 X 6



H.185 X L.200 mm.  
Art. 03.051.01 ≙ 12 X 6  
Art. 03.051.06 ≙ 14 X 6

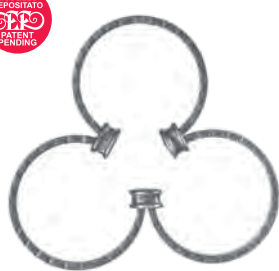

H.185 X L.200 mm.  
Art. 03.051.02 ≙ 12 X 6  
Art. 03.051.07 ≙ 14 X 6  
Modello Scala / Scala Model



H.380 X L.135 mm.  
Art. 03.051.03 ≙ 12 X 6



H.300 X L.115 mm.  
Art. 03.051.04 ≙ 12 X 6  
Art. 03.051.05 ≙ 14 X 6  
Modello Scala / Scala Model



Liscio / Smooth  
H.440 x L.160 mm  
Art. 03.051.08 ≙ 14 x 6 mm  
Art. 03.051.09 ≙ 16 x 6 mm



Liscio / Smooth  
H.420 x L.180 mm  
Art. 03.051.10 ≠ 12 x 6  
Art. 03.051.11 ≠ 14 x 6

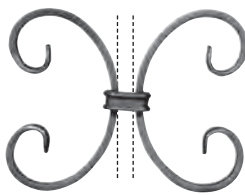

H.135 X L.165 mm.  
Art. 03.052 ≙ 12 X 6

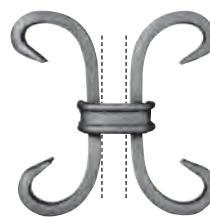

H.95 X L.95 mm.  
Art. 03.053 ≙ 12 X 6

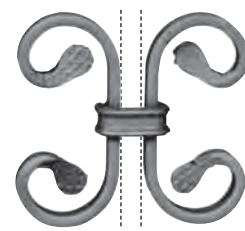

H.100 X L.110 mm.  
Art. 03.054 ≙ 12 X 6



Liscio / Smooth  
H.200 X L.190 mm.  
Art. 03.055 Ø 10



🌀 Liscio / Smooth  
H.100 X L.210 mm.  
Art. 03.056 ≙ 12 X 6



Liscio / Smooth  
H.100 X L.265 mm.  
Art. 03.057 Ø 10



Liscio / Smooth  
H.85 X L.230 mm.  
Art. 03.058 ≙ 12 X 6



Liscio / Smooth  
H.250 X L.170 mm.  
Art. 03.059 □ 14 X 14



Liscio / Smooth  
H.190 mm.  
Art. 03.060 ≙ 12 X 6



Liscio / Smooth  
H.290 X L.100 mm.  
Art. 03.061 ≙ 12 X 6



Liscio / Smooth  
H.125 mm.  
Art. 03.062 □ 8 X 8



Liscio / Smooth  
H.340 mm.  
Art. 03.063 Ø 12  
Sinistro - Left



Liscio / Smooth  
H.340 mm.  
Art. 03.064 Ø 12  
Destro - Right



Liscio / Smooth  
H.390 X L.200 mm.  
Art. 03.065 Ø 8



Liscio / Smooth  
H.370 X L.240 mm.  
Art. 03.066 Ø 10

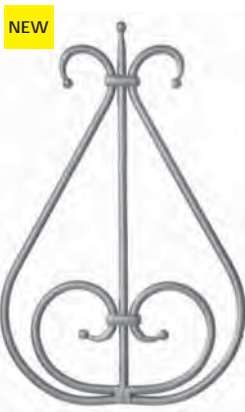

Liscio / Smooth  
H.465 x L.300 mm  
Art. 03.066.01 Ø 12

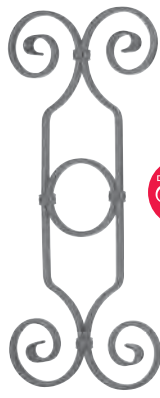

Liscio / Smooth  
H.470 X L.210 mm.  
Art. 03.067 ≙ 12 X 6  
Art. 03.067.01 ≙ 14 X 6

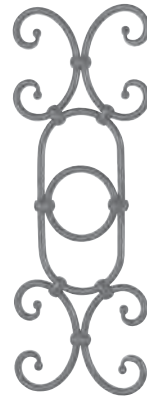

Liscio / Smooth  
H.495 X L.180 mm.  
Art. 03.068 Ø 10

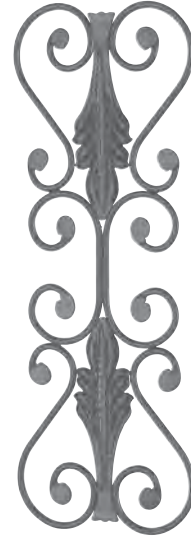

Liscio / Smooth  
H.620 X L.235 mm.  
Art. 03.069 Ø 8



Liscio / Smooth  
H.460 X L.185 mm.  
Art. 03.070 ≙ 12 X 6  
Art. 03.070.01 ≙ 14 X 6

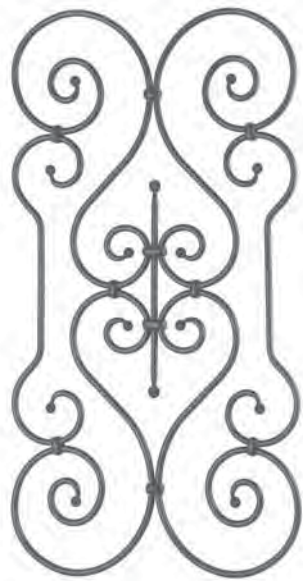

Liscio / Smooth  
H.840 X L.440 mm.  
Art. 03.071 Ø 10  
Art. 03.071.01 Ø 12



Liscio / Smooth  
H.400 X L.125 mm  
Art. 03.080 □ 12 X 12



Liscio / Smooth  
H.400 X L.125 mm.  
Art. 03.081 Ø 12

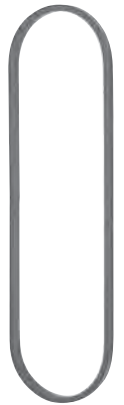

Liscio / Smooth  
H.400 X L.115 mm.  
Art. 03.082 ≙ 12 X 6

OVALI NON SALDATI / NOT WELDED OVALS



Mod. Scala / Scala Model  
H.400 X L.115 mm.  
Art. 03.083 ≙ 12 X 6



Liscio / Smooth  
H.400 X L.125 mm  
Art. 03.084 □ 12 X 12



Liscio / Smooth  
H.400 X L.125 mm.  
Art. 03.085 Ø 12



Liscio / Smooth  
H.400 X L.115 mm.  
Art. 03.086 ≙ 12 X 6



Mod. Scala / Scala Model  
H.400 X L.115 mm.  
Art. 03.087 ≙ 12 X 6



Liscio / Smooth  
Art. 03.088 □ 14 H.710 x L.126 mm  
Art. 03.088.01 □ 14 H.590 x L.126 mm  
Art. 03.088.02 □ 14 H.540 x L.126 mm  
Art. 03.088.03 □ 14 H.410 x L.126 mm

Tutte le parti di questo catalogo - foto comprese - sono di proprietà Euro-Fer. La riproduzione, anche parziale, è vietata in ogni forma e con ogni mezzo. / Every part of this catalogue - photos included - is Euro-Fer's property. All forms of copying are strictly prohibited.



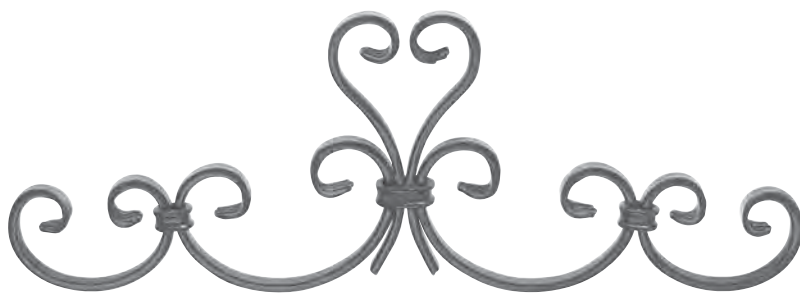

Liscio / Smooth  
H.175 X L.500 mm.  
Art. 03.090  $\neq$  12 X 6



Liscio / Smooth  
H.210 X L.530 mm.  
Art. 03.091  $\neq$  12  
Art. 03.091.01  $\neq$  14



Liscio / Smooth  
H.260 X L.885 mm.  
Art. 03.092  $\neq$  12



Liscio / Smooth  
H.300 X L.835 mm.  
Art. 03.093  $\neq$  20 X 5



Liscio / Smooth  
H.235 X L.580 mm.  
Art. 03.094  $\neq$  10



Liscio / Smooth  
H.235 X L.860 mm.  
Art. 03.095  $\neq$  10



Liscio / Smooth  
 H.330 X L.1000 mm.  
 Art. 03.096 □ 12  
 Art. 03.096.01 □ 14  
 Art. 03.096.02 □ 16



Liscio / Smooth  
 L.1000 x H.110 mm  
 Art. 03.096.50 Ø 10  
 Con fiori su ambo i lati /  
 Flowers on both sides



Liscio / Smooth  
 L.1000 x H.110 mm  
 Art. 03.096.51 □ 10  
 Con fiori su ambo i lati /  
 Flowers on both sides



Attorcigliato / Twisted  
 L.1000 x H.110 mm  
 Art. 03.096.52 □ 10  
 Con fiori su ambo i lati /  
 Flowers on both sides



Modello Scala / Scala Model  
 L.1000 x H.110 mm  
 Art. 03.096.53 ≧ 12 x 6  
 Con fiori su ambo i lati /  
 Flowers on both sides



Liscio / Smooth  
 L.1230 x H.350 mm  
 Art. 03.097 ≧ 30 x 10

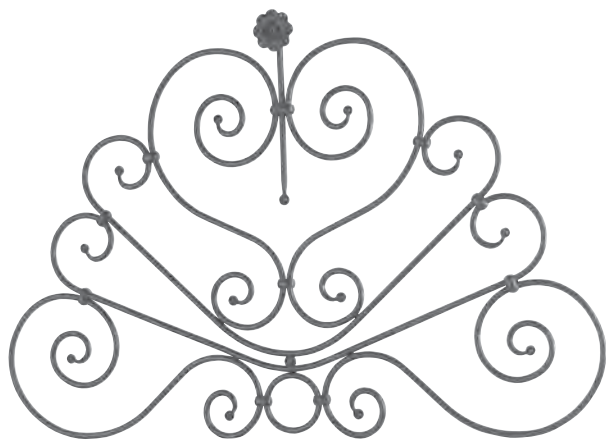

Liscio / Smooth  
 H.630 X L.930 mm.  
 Art. 03.100 Ø 10  
 Art. 03.100.01 Ø 12



Liscio / Smooth  
 H.900 X L.1300 mm.  
 Art. 03.101 Ø 12



Liscio / Smooth  
H.900 X L.650 mm.  
Art. 03.102  $\varnothing$  12  
Sinistro - Left

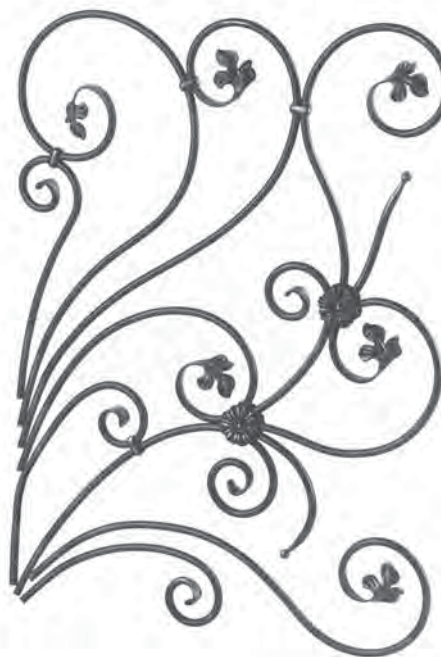

Liscio / Smooth  
H.900 X L.650 mm.  
Art. 03.103  $\varnothing$  12  
Destro - Right

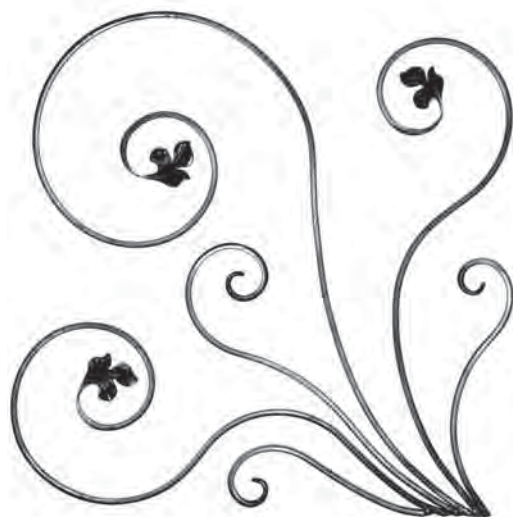

Liscio / Smooth  
H.600 x L.600 mm  
Art. 03.104  $\varnothing$  16 x 8  
Sinistro / Left



Liscio / Smooth  
H.600 x L.600 mm  
Art. 03.105  $\varnothing$  16 x 8  
Destro / Right



Martellato / Hammered  
H.600 x L.600 mm  
Art. 03.106  $\varnothing$  16 x 8  
Sinistro / Left



Martellato / Hammered  
H.600 x L.600 mm  
Art. 03.107  $\varnothing$  16 x 8  
Destro / Right





**Art. 03.400**  
Liscio / Smooth  
H.296 x L.296 mm ca.  
□ 12 mm

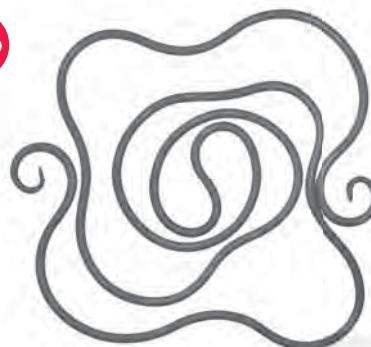

**Art. 03.600**  
Martellato / Hammered  
H.400 x L.400 mm ca.  
Ø 12 mm

**Art. 03.602**  
Liscio / Smooth  
H.400 x L.400 mm ca.  
Ø 10 mm

**Art. 03.601**  
Modello Corteccia / Bark Model  
H.400 x L.400 mm ca.  
Ø 12 mm

**Art. 03.610**  
Liscio / Smooth  
H. 400 x L.400 mm c.a.  
□ 10 mm



Martellato / Hammered  
H.85 x L.295 mm  
**Art. 03.645** ≙ 12 x 6  
**Art. 03.645.01** ≙ 16 x 8 **NEW**

Liscio / Smooth  
H.85 x L.295 mm **NEW**  
**Art. 03.646** ≙ 12 x 6  
**Art. 03.646.01** ≙ 16 x 8



Martellato / Hammered  
H.270 x L.245 mm  
**Art. 03.650** ≙ 12 x 6

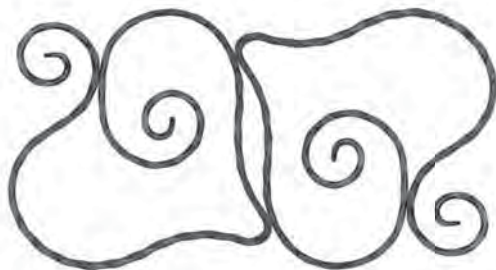

Martellato / Hammered  
H.235 x L.390 mm  
**Art. 03.651.** ≙ 12 x 6

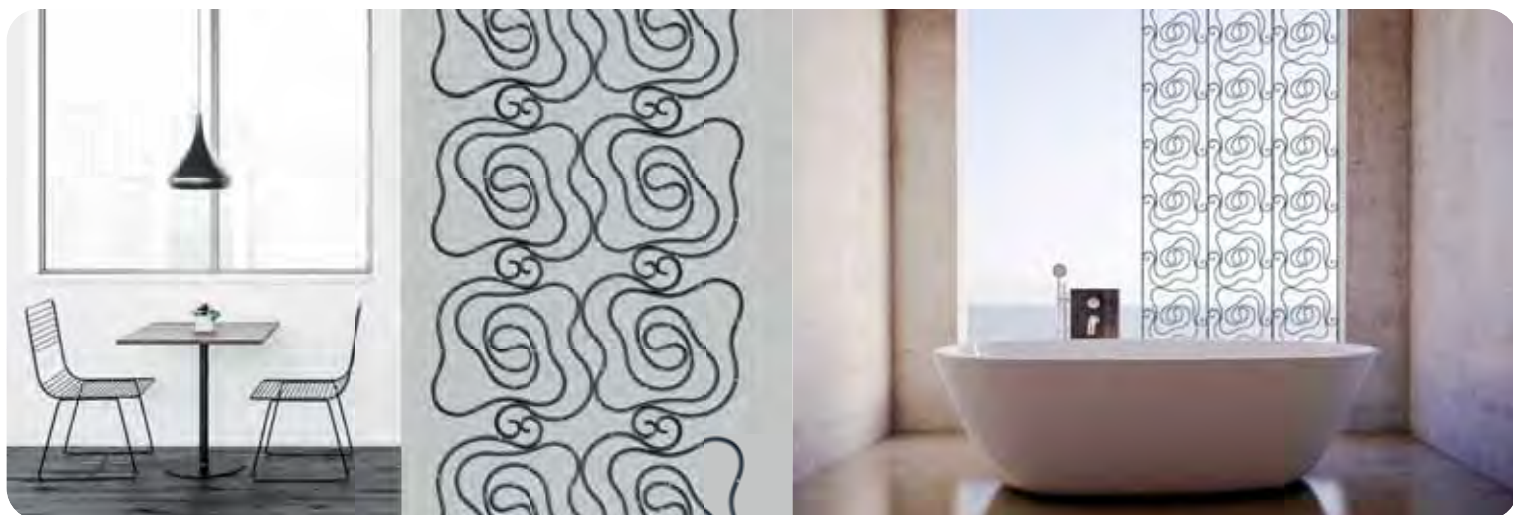

🌀 fiori da entrambi i lati / flowers on both sides

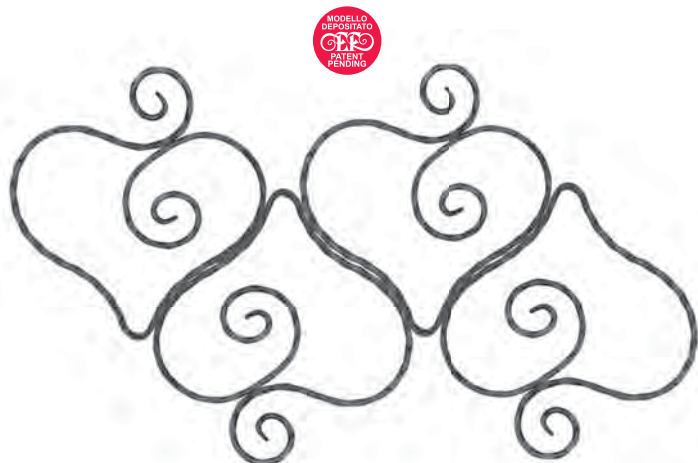

Martellato / *Hammered*  
H.410 x L.620 mm  
Art. 03.652. ≙ 12 x 6

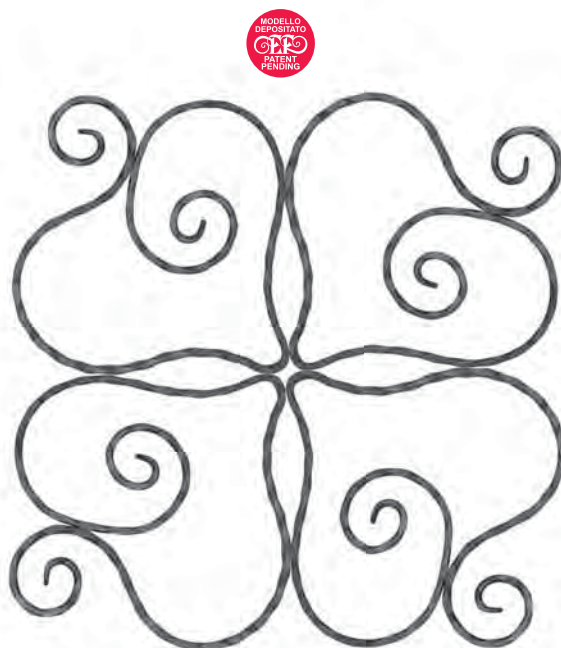

Martellato / *Hammered*  
H.430 x L.430 mm  
Art. 03.655. ≙ 12 x 6

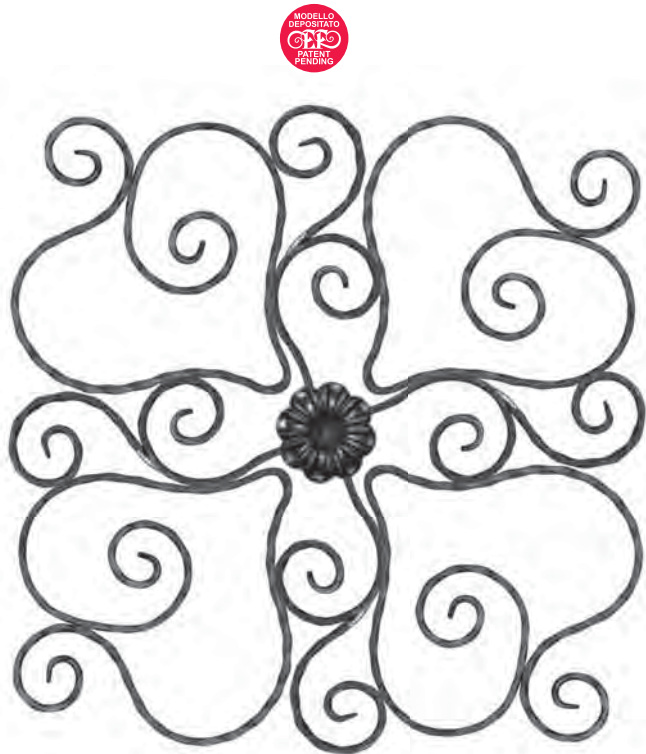

🌀 Martellato / *Hammered*  
H.510 x L.510 mm  
Art. 03.657 ≙ 12 x 6





🌀 fiori da entrambi i lati / flowers on both sides

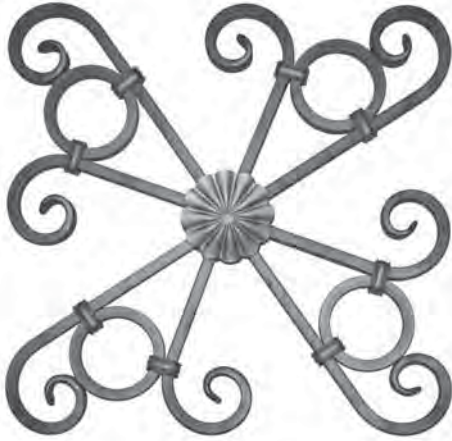

🌀 Liscio / Smooth  
H.460 x L.460 mm  
Art. 03.700 □ 12 mm



Liscio / Smooth  
H.420 x L.420 mm  
Art. 03.701 Ø 12 mm

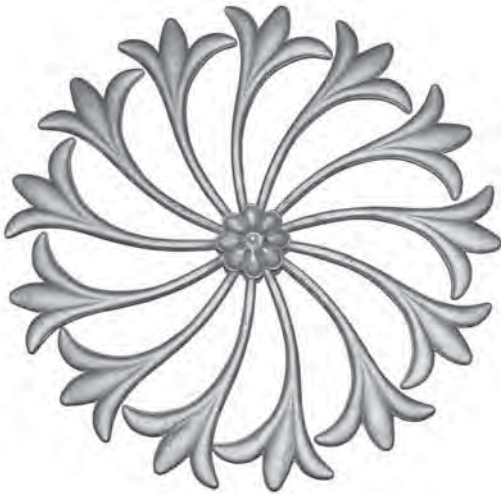

🌀 Liscio / Smooth  
H.400 x L.400 mm  
Art. 03.702  
spessore / thickness 10 mm



Liscio / Smooth  
H.460 x L.460 mm  
Art. 03.703 Ø 12 mm

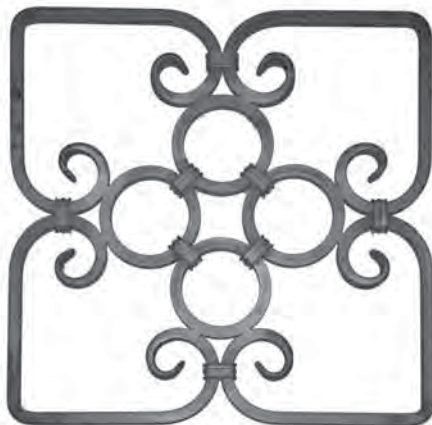

Liscio / Smooth  
H.415 x L.415 mm  
Art. 03.704 □ 12 mm

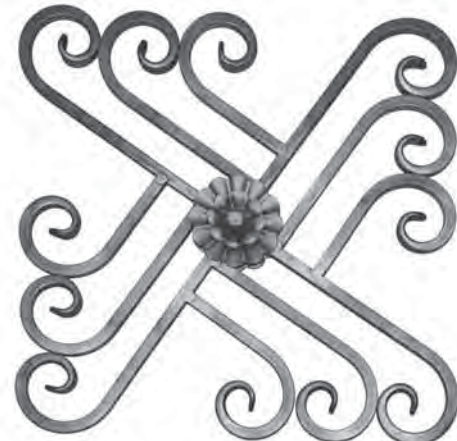

🌀 Liscio / Smooth  
H.460 x L.460 mm  
Art. 03.705 □ 12 mm

Tutte le parti di questo catalogo - foto comprese - sono di proprietà Euro-Fer. La riproduzione, anche parziale, è vietata in ogni forma e con ogni mezzo. / Every part of this catalogue - photos included - is Euro-Fer's property. All forms of copying are strictly prohibited.



🌀 fiori da entrambi i lati / flowers on both sides

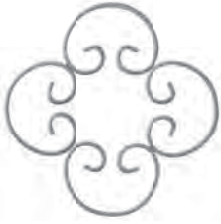

Liscio / Smooth  
H.215 x L.215 mm  
Art. 03.706 ≙ 16 x 4



Liscio / Smooth  
H.200 x L.200 mm  
Art. 03.707 Ø 12



🌀 Liscio / Smooth  
H.260 x L.260 mm  
Art. 03.708 ≙ 12 x 6



Liscio / Smooth  
H.250 x L.250 mm  
Art. 03.709 Ø 12

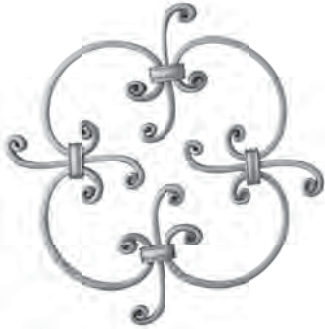

Liscio / Smooth  
H.250 x L.250 mm  
Art. 03.710 ≙ 14 x 6

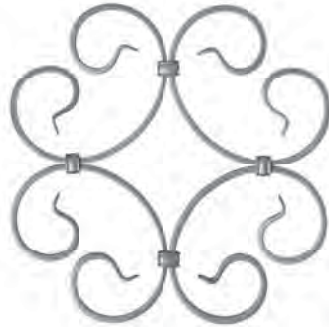

Liscio / Smooth  
H.290 x L.290 mm  
Art. 03.711 ≙ 12 x 6

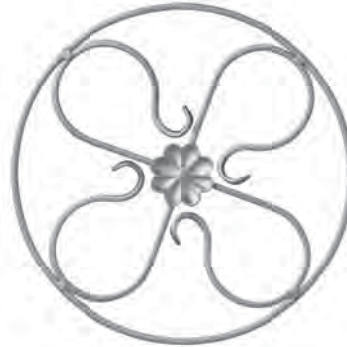

🌀 Liscio / Smooth  
H.300 x L.300 mm  
Art. 03.712 ≙ 12 x 6

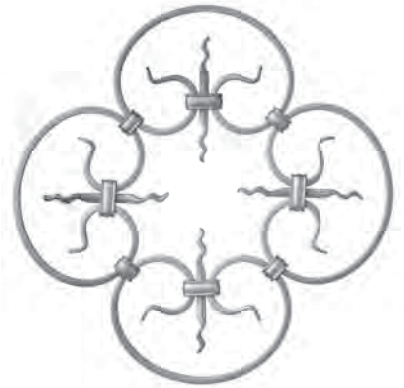

Liscio / Smooth  
H.330 x L.330 mm  
Art. 03.713 ≙ 12 x 6



🌀 Liscio / Smooth  
H.250 x L.250 mm  
Art. 03.714 ≙ 16 x 8

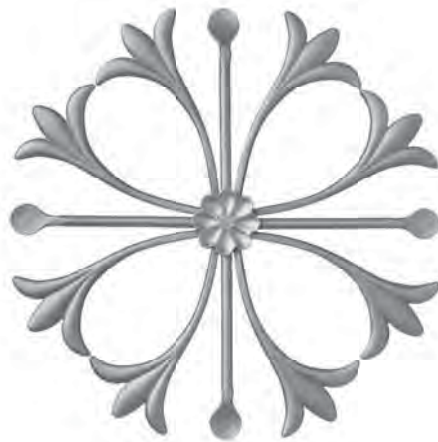

🌀 Liscio / Smooth  
H.380 x L.380 mm  
Art. 03.715 Ø 10

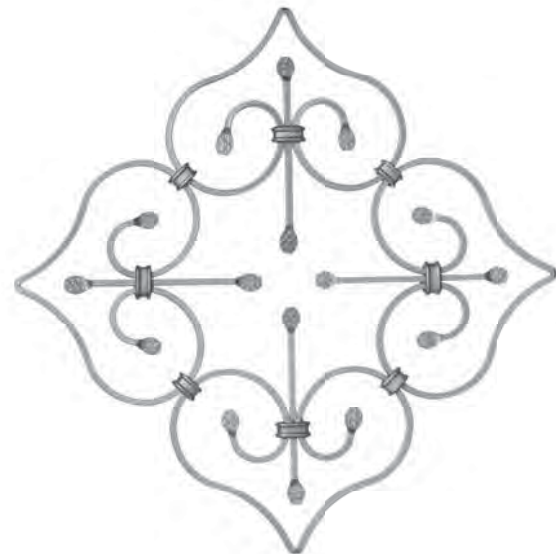

Liscio / Smooth  
H.480 x L.480 mm  
Art. 03.716 ≙ 12 x 6

🌀 fiori da entrambi i lati / flowers on both sides



🌀 Liscio / Smooth  
H.400 x L.400 mm  
Art. 03.717 ≙ 12 x 6  
fiore / flower 95 mm

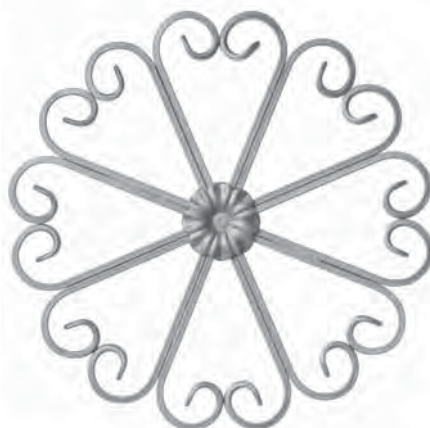

🌀 Liscio / Smooth  
H.330 x L.330 mm  
Art. 03.718 ≙ 12 x 6  
fiore / flower 60 mm



Mod. Scala / Scala model  
Ø 270 mm  
Art. 03.719 ≙ 12 x 6



🌀 Liscio / Smooth  
Ø 215 mm  
Art. 03.720 ≙ 14 x 6



🌀 Liscio / Smooth  
Ø 190 mm  
Art. 03.721 ≙ 12 x 6

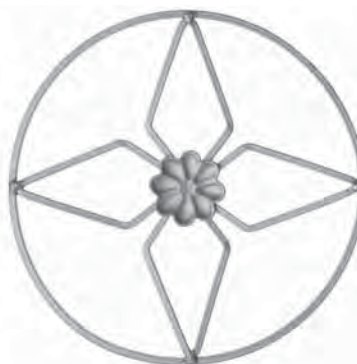

🌀 Liscio / Smooth  
Ø 280 mm  
Art. 03.722 ≙ 12 x 6

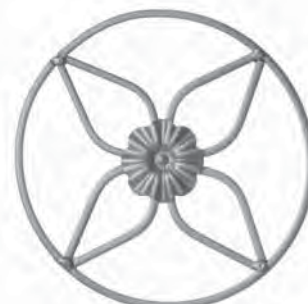

🌀 Liscio / Smooth  
Ø 220 mm  
Art. 03.723 ≙ 14 x 6

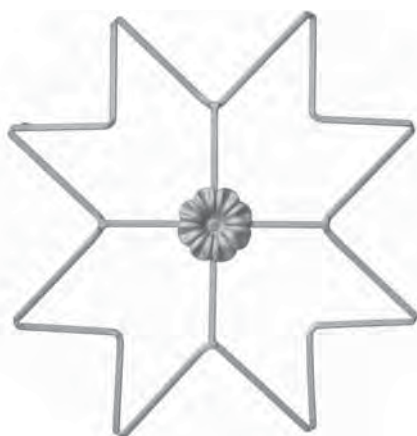

🌀 Liscio / Smooth  
H.360 x L.360 mm  
Art. 03.724 ≙ 12 x 6  
fiore / flower 60 mm

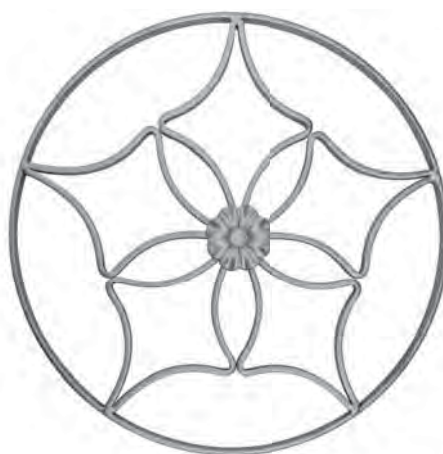

🌀 Liscio / Smooth  
Ø 400 mm  
Art. 03.725 ≙ 12 x 6  
fiore / flower 60 mm

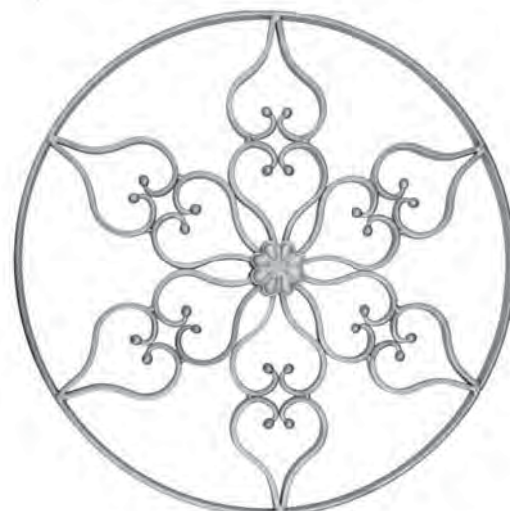

🌀 Liscio / Smooth  
Ø 500 mm  
Art. 03.726 ≙ 12 x 6  
fiore / flower 60 mm



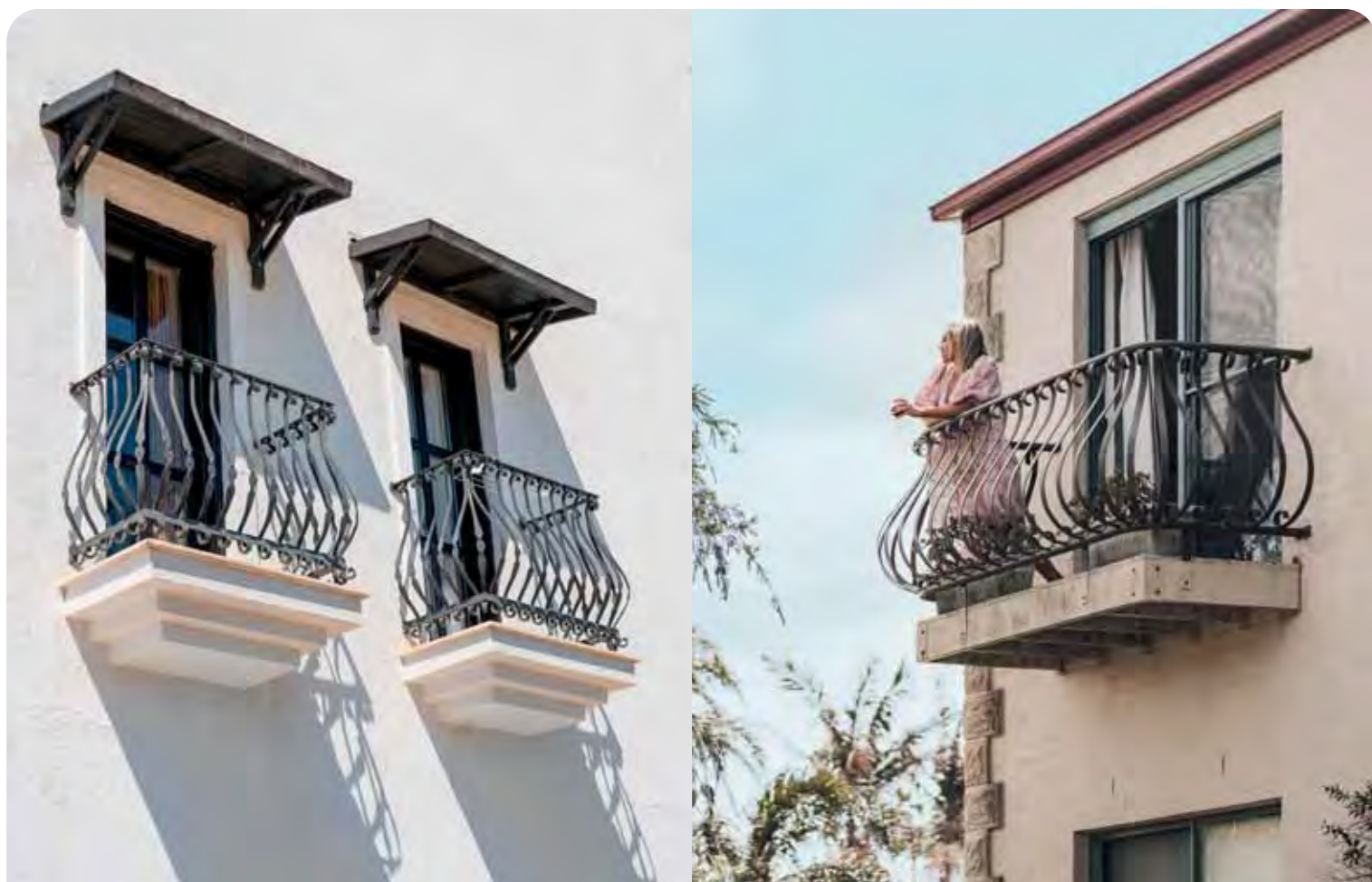

Tutte le parti di questo catalogo - foto comprese - sono di proprietà Euro-Fer. La riproduzione, anche parziale, è vietata in ogni forma e con ogni mezzo. / Every part of this catalogue - photos included - is Euro-Fer's property. All forms of copying are strictly prohibited.



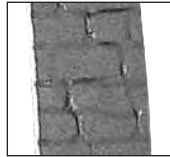

Modello Mattone  
Brick Model



H.950 X L.300 mm.  $\neq$  40 X 4  
Art. 04.001 Liscio / Smooth  
Art. 04.002 Mattone / Brick



H.720 X L.250 mm.  $\neq$  40 X 4  
Art. 04.003 Liscio / Smooth  
Art. 04.004 Mattone / Brick



H.720 X L.250 mm.  $\neq$  40 X 4  
Art. 04.005 Liscio / Smooth  
Art. 04.006 Mattone / Brick



H.950 X L.220 mm.  $\neq$  40 X 4  
Art. 04.007 Liscio / Smooth  
Art. 04.008 Mattone / Brick



H.950 X L.180 mm.  $\neq$  40 X 4  
Art. 04.009 Liscio / Smooth  
Art. 04.010 Mattone / Brick



H.370 X L.125 mm.  $\neq$  40 X 4  
Art. 04.011 Liscio / Smooth  
Art. 04.012 Mattone / Brick



Liscio / Smooth  
H.440 X L.75 mm.  
Art. 04.012.01  $\neq$  40 X 4

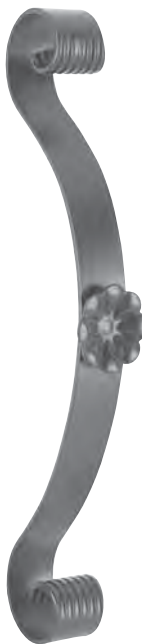

Liscio / Smooth  
H.440 X L.75 mm.  
Art. 04.012.02  $\neq$  40 X 4



Mattone / Brick  
H.440 X L.75 mm.  
Art. 04.012.03  $\neq$  40 X 4



Mattone / Brick  
H.440 X L.75 mm.  
Art. 04.012.04  $\neq$  40 X 4



H.800 X L.135 mm. Liscio / Smooth  
 Art. 04.013  $\neq$  20 X 4  
 Art. 04.014  $\neq$  25 X 4  
 Art. 04.015  $\neq$  30 X 4  
 Art. 04.016  $\neq$  40 X 4



H.800 X L.135 mm. Mattone / Brick  
 Art. 04.017  $\neq$  20 X 4  
 Art. 04.018  $\neq$  25 X 4  
 Art. 04.019  $\neq$  30 X 4  
 Art. 04.020  $\neq$  40 X 4



H.900 X L.240 mm.  $\neq$  40 X 6  
 Art. 04.021 Liscio / Smooth



Liscio / Smooth  
 H.950 X L.240 mm.  
 Art. 04.021.01  $\neq$  40 X 4



Liscio / Smooth  
 H.950 X L.240 mm.  
 Art. 04.021.02  $\neq$  40 X 4



Liscio / Smooth  
 H.950 X L.240 mm.  
 Art. 04.021.03  $\neq$  40 X 4



Mattone / Brick  
 H.950 X L.240 mm.  
 Art. 04.021.04  $\neq$  40 X 4



Mattone / Brick  
 H.950 X L.240 mm.  
 Art. 04.021.05  $\neq$  40 X 4

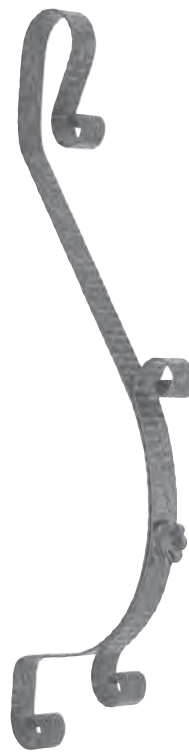

Mattone / Brick  
 H.950 X L.240 mm.  
 Art. 04.021.06  $\neq$  40 X 4



H.950 x L.190 mm  
 Martellato / Hammered  
 Art. 04.021.10  $\neq$  30 x 8 mm  
 Liscio / Smooth  
 Art. 04.021.11  $\neq$  30 x 8 mm



H.750 X L.110 mm.  
 Art. 04.022 ≡ 20 X 4  
 Art. 04.023 ≡ 20 X 5



H.900 X L.180 mm.  
 Art. 04.024 ≡ 16 X 4  
 Art. 04.025 ≡ 20 X 6  
 Art. 04.026 □ 8 X 8



H.850 X L.170 mm.  
 Art. 04.027 ≡ 25 X 5



H.780 X L.250 mm.  
 Art. 04.028 ≡ 30 X 4  
 Art. 04.029 ≡ 25 X 5



Liscio / Smooth  
 H.730 x L.250 mm  
 Art. 04.029.01 ≡ 30 x 10



H.720 X L.130 mm.  
 Art. 04.030 ≡ 16 X 4  
 Art. 04.031 ≡ 10 X 5  
 Art. 04.032 ≡ 20 X 6  
 Art. 04.033 □ 8 X 8



H.720 X L.75 mm.  
 Art. 04.034 ≡ 16 X 4  
 Art. 04.035 ≡ 10 X 5  
 Art. 04.036 ≡ 20 X 6  
 Art. 04.037 □ 8 X 8



H.720 X L.75 mm.  
 Art. 04.038 ≡ 16 X 4  
 Art. 04.039 ≡ 10 X 5  
 Art. 04.040 ≡ 20 X 6  
 Art. 04.041 □ 8 X 8



H.800 X L.115 mm.  
 Art. 04.042 ≡ 16 X 4  
 Art. 04.043 ≡ 20 X 4  
 Art. 04.044 ≡ 25 X 4



H.720 X L.75 mm.  
 Art. 04.045 ≡ 16 X 4  
 Art. 04.046 ≡ 10 X 5  
 Art. 04.047 ≡ 20 X 6

Tutte le parti di questo catalogo - foto comprese - sono di proprietà Euro-Fer. La riproduzione, anche parziale, è vietata in ogni forma e con ogni mezzo. / Every part of this catalogue - photos included - is Euro-Fer's property. All forms of copying are strictly prohibited.





Modello Scala / *Scala Model*  
 L.100 mm.  $\neq$  20 X 6  
 Art. 04.048.01 H.1000 mm.  
 Art. 04.048.02 H.1500 mm.



Modello Mattone / *Brick Model*  
 H. 1000 X L.110 mm.  
 Art. 04.048.03  $\square$  12 X 12



H.950 X L.100 mm.  
 Art. 04.048.04  $\neq$  12 X 6  
 Art. 04.048.05  $\neq$  14 X 6



NEW



H.1000 x L.160 mm  
 Mattone / *Brick*  
 Art. 04.048.10  $\neq$  40 x 8 mm



NEW



H.1000 x L.120 mm  
 Mattone / *Brick*  
 Art. 04.048.11  $\neq$  40 x 8 mm



H.950 X L.100 mm.  
 Art. 04.048.06  $\square$  12 X 12  
 Art. 04.048.07  $\square$  14 X 14



H.950 X L.125 mm.  
 Art. 04.048.08  $\neq$  12 X 6  
 Art. 04.048.09  $\neq$  14 X 6



Tutte le parti di questo catalogo - foto comprese - sono di proprietà Euro-Fer. La riproduzione, anche parziale, è vietata in ogni forma e con ogni mezzo. / Every part of this catalogue - photos included - is Euro-Fer's property. All forms of copying are strictly prohibited.



L.170 mm. □ 10 X 10  
**Art. 04.049** H. 720 mm.  
**Art. 04.050** H. 820 mm.  
**Art. 04.051** H. 900 mm.  
**Art. 04.052** H.1000 mm.

L.170 mm. □ 12 X 12  
**Art. 04.053** H. 720 mm.  
**Art. 04.054** H. 820 mm.  
**Art. 04.055** H. 900 mm.  
**Art. 04.056** H.1000 mm.



L.115 mm. □ 12 X 12  
**Art. 04.056.01** H. 650 mm.  
**Art. 04.056.02** H. 720 mm.  
**Art. 04.056.03** H.1200 mm.



Martellato / Hammered  
 L.90 mm. □ 12 X 12  
**Art. 04.056.07** H. 650 mm.  
**Art. 04.056.08** H. 720 mm.  
**Art. 04.056.09** H.1200 mm.



H.520 X L.200 mm.  
**Art. 04.056.13** □ 12 X 12  
**Art. 04.056.17** □ 14 X 14  
**Art. 04.056.18** □ 16 X 16



H.690 X L.260 mm.  
**Art. 04.056.14** □ 20 X 20

L.115 mm. □ 14 X 14  
**Art. 04.056.04** H. 650 mm.  
**Art. 04.056.05** H. 720 mm.  
**Art. 04.056.06** H.1200 mm.

L.90 mm. □ 14 X 14  
**Art. 04.056.10** H. 650 mm.  
**Art. 04.056.11** H. 720 mm.  
**Art. 04.056.12** H.1200 mm.



L.235 mm. ≡ 20 X 6  
**Art. 04.056.15** H.660 mm.  
**Art. 04.056.16** H.760 mm.



Liscio / Smooth  
 H.600 x L.290 mm  
**Art. 04.056.20** □ 12



L.250 mm. □ 12 X 12  
**Art. 04.057** H. 720 mm.  
**Art. 04.058** H. 820 mm.  
**Art. 04.059** H. 900 mm.  
**Art. 04.060** H. 1200 mm.  
**Art. 04.061** H. 1500 mm.  
**Art. 04.062** H. 1800 mm.

L.250 mm. □ 14 X 14  
**Art. 04.057.01** H. 720 mm.  
**Art. 04.058.01** H. 820 mm.  
**Art. 04.059.01** H. 900 mm.  
**Art. 04.060.01** H.1200 mm.  
**Art. 04.061.01** H.1500 mm.  
**Art. 04.062.01** H.1800 mm.

L.250 mm. □ 16 X 16  
**Art. 04.057.02** H. 720 mm.  
**Art. 04.058.02** H. 820 mm.  
**Art. 04.059.02** H. 900 mm.  
**Art. 04.060.02** H.1200 mm.  
**Art. 04.061.02** H 1500 mm.  
**Art. 04.062.02** H 1800 mm.



Modello Scala / Scala Model  
 H.380 x L.135 mm  
**Art. 04.062.10** ≡ 12 x 6 mm

NEW



Rigato / Fluted

L.210 mm. □ 12 X 12  
**Art. 04.063** H.1000 mm.  
**Art. 04.064** H.1200 mm.



Rigato / Fluted

L.210 mm. □ 12 X 12  
**Art. 04.065** H.1000 mm.  
**Art. 04.066** H.1200 mm.



L.200 mm. □ 12 X 12  
**Art. 04.067** H. 950 mm.  
**Art. 04.068** H.1200 mm.  
**Art. 04.069** H.1500 mm.  
**Art. 04.070** H.1800 mm.



L.125 mm. □ 12 X 12  
**Art. 04.075** H. 950 mm.  
**Art. 04.076** H.1200 mm.  
**Art. 04.077** H.1500 mm.  
**Art. 04.078** H.1800 mm.



L.125 mm. □ 12 X 12  
**Art. 04.083** H. 950 mm.  
**Art. 04.084** H.1200 mm.  
**Art. 04.085** H.1500 mm.  
**Art. 04.086** H.1800 mm.



Liscio / Smooth  
 H.950 X L.205 mm.  
**Art. 04.090.01** □ 14 X 14

L.200 mm. □ 14 X 14  
**Art. 04.071** H. 950 mm.  
**Art. 04.072** H.1200 mm.  
**Art. 04.073** H.1500 mm.  
**Art. 04.074** H.1800 mm.

L.125 mm. □ 14 X 14  
**Art. 04.079** H. 950 mm.  
**Art. 04.080** H.1200 mm.  
**Art. 04.081** H.1500 mm.  
**Art. 04.082** H.1800 mm.

L.125 mm. □ 14 X 14  
**Art. 04.087** H. 950 mm.  
**Art. 04.088** H.1200 mm.  
**Art. 04.089** H.1500 mm.  
**Art. 04.090** H.1800 mm.



Martellato / Hammered  
 H.950 x L.125 mm

**Art. 04.090.09** □ 12 X 12 mm



Liscio / Smooth  
 H.950 mm

**Art. 04.090.10** □ 12  
**Art. 04.090.11** □ 14  
**Art. 04.090.12** □ 16



L.200 mm. □ 12 X 12  
**Art. 04.091** H. 950 mm.  
**Art. 04.092** H.1200 mm.  
**Art. 04.093** H.1500 mm.  
**Art. 04.094** H.1800 mm.



H.950 X L.170 mm.  
**Art. 04.095** □ 12 X 12



H.540 X L.115 mm.  
**Art. 04.096** □ 10 X 10  
**Art. 04.097** □ 12 X 12

Martellato / Hammered  
 H.540 X L.115 mm.

**Art. 04.098** □ 12 X 12

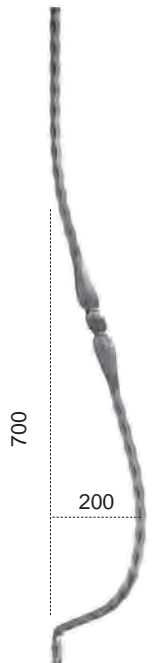

Martellato / Hammered

L.200 mm. □ 12 X 12  
**Art. 04.098.01** H. 950 mm.  
**Art. 04.098.02** H.1200 mm.  
**Art. 04.098.03** H.1500 mm.  
**Art. 04.098.04** H.1800 mm.

L.200 mm. □ 14 X 14  
**Art. 04.098.05** H. 950 mm.  
**Art. 04.098.06** H.1200 mm.  
**Art. 04.098.07** H.1500 mm.  
**Art. 04.098.08** H.1800 mm.



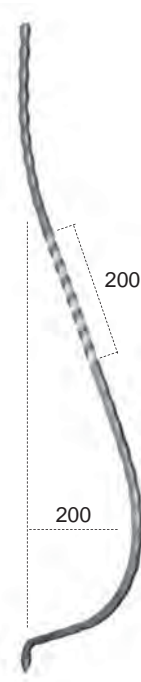
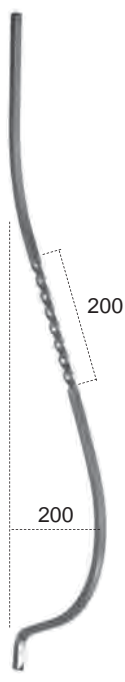

*Tondo / Round*

L.200 mm. □ 12 X 12  
**Art. 04.098.09** H. 950 mm.  
**Art. 04.098.10** H.1200 mm.  
**Art. 04.098.11** H.1500 mm.  
**Art. 04.098.12** H.1800 mm.

L.200 mm. Ø 14  
**Art. 04.098.17** H. 950 mm.  
**Art. 04.098.18** H.1200 mm.  
**Art. 04.098.19** H.1500 mm.  
**Art. 04.098.20** H.1800 mm.

L.200 mm. □ 12 X 12  
**Art. 04.098.25** H. 950 mm.  
**Art. 04.098.26** H.1200 mm.  
**Art. 04.098.27** H.1500 mm.  
**Art. 04.098.28** H.1800 mm.

*Martellato / Hammered*

L.200 mm. □ 12 X 12  
**Art. 04.099** H. 950 mm.  
**Art. 04.100** H.1200 mm.  
**Art. 04.101** H.1500 mm.  
**Art. 04.102** H.1800 mm.

*Martellato / Hammered*

L.200 mm. □ 12 X 12  
**Art. 04.103** H. 950 mm.  
**Art. 04.104** H.1200 mm.  
**Art. 04.105** H.1500 mm.  
**Art. 04.106** H.1800 mm.

L.200 mm. □ 12 X 12  
**Art. 04.106.05** H. 950 mm.  
**Art. 04.106.06** H.1200 mm.  
**Art. 04.106.07** H.1500 mm.  
**Art. 04.106.08** H.1800 mm.

L.200 mm. □ 14 X 14  
**Art. 04.098.13** H. 950 mm.  
**Art. 04.098.14** H.1200 mm.  
**Art. 04.098.15** H.1500 mm.  
**Art. 04.098.16** H.1800 mm.

L.200 mm. Ø 16  
**Art. 04.098.21** H. 950 mm.  
**Art. 04.098.22** H.1200 mm.  
**Art. 04.098.23** H.1500 mm.  
**Art. 04.098.24** H.1800 mm.

L.200 mm. □ 14 X 14  
**Art. 04.098.29** H. 950 mm.  
**Art. 04.098.30** H.1200 mm.  
**Art. 04.098.31** H.1500 mm.  
**Art. 04.098.32** H.1800 mm.

L.200 mm. □ 14 X 14  
**Art. 04.106.01** H. 950 mm.  
**Art. 04.106.02** H.1200 mm.  
**Art. 04.106.03** H.1500 mm.  
**Art. 04.106.04** H.1800 mm.

L.200 mm. □ 14 X 14  
**Art. 04.106.09** H. 950 mm.  
**Art. 04.106.10** H.1200 mm.  
**Art. 04.106.11** H.1500 mm.  
**Art. 04.106.12** H.1800 mm.



*Tondo / Round*

L.200 mm. Ø 14  
**Art. 04.106.13** H. 950 mm.  
**Art. 04.106.14** H.1200 mm.  
**Art. 04.106.15** H.1500 mm.  
**Art. 04.106.16** H.1800 mm.

L.200 mm. Ø 16  
**Art. 04.106.17** H. 950 mm.  
**Art. 04.106.18** H.1200 mm.  
**Art. 04.106.19** H.1500 mm.  
**Art. 04.106.20** H.1800 mm.

L.200 mm. Ø 12  
**Art. 04.106.40** H. 950 mm.  
**Art. 04.106.41** H.1200 mm. **NEW**  
**Art. 04.106.42** H.1500 mm.  
**Art. 04.106.43** H.1800 mm.

*Attorcigliato, Martellato e Rigato  
 Fluted, Hammered and Twisted*  
 L.200 mm. □ 14 X 14  
**Art. 04.106.21** H.950 mm.

*Martellato / Hammered*  
 L.200 mm. □ 12 X 12  
**Art. 04.106.30** H.950 mm.

*Martellato / Hammered*  
 L.200 mm. □ 12 X 12  
**Art. 04.106.31** H.950 mm.

*Martellato / Hammered*  
 L.200 mm. □ 12 X 12  
**Art. 04.107** H. 950 mm.  
**Art. 04.108** H.1200 mm.  
**Art. 04.109** H.1500 mm.  
**Art. 04.110** H.1800 mm.

L.200 mm. □ 14 X 14  
**Art. 04.110.01** H. 950 mm.  
**Art. 04.110.02** H.1200 mm.  
**Art. 04.110.03** H.1500 mm.  
**Art. 04.110.04** H.1800 mm.

Tutte le parti di questo catalogo - foto comprese - sono di proprietà Euro-Fer. La riproduzione, anche parziale, è vietata in ogni forma e con ogni mezzo. / Every part of this catalogue - photos included - is Euro-Fer's property. All forms of copying are strictly prohibited.



L.200 mm. □ 12 X 12  
 Art. 04.110.05 H. 950 mm.  
 Art. 04.110.06 H.1200 mm.  
 Art. 04.110.07 H.1500 mm.  
 Art. 04.110.08 H.1800 mm.

Martellato / Hammered  
 L.200 mm. □ 12 X 12  
 Art. 04.111 H. 950 mm.  
 Art. 04.112 H.1200 mm.  
 Art. 04.113 H.1500 mm.  
 Art. 04.114 H.1800 mm.

L.200 mm. □ 12 X 12  
 Art. 04.114.05 H. 950 mm.  
 Art. 04.114.06 H.1200 mm.  
 Art. 04.114.07 H.1500 mm.  
 Art. 04.114.08 H.1800 mm.

Martellato / Hammered  
 L.200 mm. □ 12 X 12  
 Art. 04.115 H. 950 mm.  
 Art. 04.116 H.1200 mm.  
 Art. 04.117 H.1500 mm.  
 Art. 04.118 H.1800 mm.

L.200 mm. □ 12 X 12  
 Art. 04.118.05 H. 950 mm.  
 Art. 04.118.06 H.1200 mm.  
 Art. 04.118.07 H.1500 mm.  
 Art. 04.118.08 H.1800 mm.

Forgiato / Forged  
 H.950 x L.150 mm  
 Art. 04.118.40 ≧ 13 x 10 mm

L.200 mm. □ 14 X 14  
 Art. 04.110.09 H. 950 mm.  
 Art. 04.110.10 H.1200 mm.  
 Art. 04.110.11 H.1500 mm.  
 Art. 04.110.12 H.1800 mm.

L.200 mm. □ 14 X 14  
 Art. 04.114.01 H. 950 mm.  
 Art. 04.114.02 H.1200 mm.  
 Art. 04.114.03 H.1500 mm.  
 Art. 04.114.04 H.1800 mm.

L.200 mm. □ 14 X 14  
 Art. 04.114.09 H. 950 mm.  
 Art. 04.114.10 H.1200 mm.  
 Art. 04.114.11 H.1500 mm.  
 Art. 04.114.12 H.1800 mm.

L.200 mm. □ 14 X 14  
 Art. 04.118.01 H. 950 mm.  
 Art. 04.118.02 H.1200 mm.  
 Art. 04.118.03 H.1500 mm.  
 Art. 04.118.04 H.1800 mm.

L.200 mm. □ 14 X 14  
 Art. 04.118.09 H. 950 mm.  
 Art. 04.118.10 H.1200 mm.  
 Art. 04.118.11 H.1500 mm.  
 Art. 04.118.12 H.1800 mm.



H.470 X L.180 mm.  
 Art. 04.119.03 ≧ 20 X 6

NEW



Tondo / Round  
 H.480 x L.190 mm  
 Art. 04.119.13 Ø 12  
 liscio / smooth



Forgiato / Forged  
 H.950 x L.150 mm  
 Art. 04.118.45 ≧ 13 x 10 mm



LISCIO / SMOOTH  
 H.720 x L.260mm  
 Art. 04.118.99 Ø 12



H.730 X L.250 mm.  
 Art. 04.119 ≧ 20 X 6



Modello Scala / Scala Model  
 H.730 X L.250 mm.  
 Art. 04.119.01 ≧ 20 X 6



Tondo / Round  
 H.750 X L.250 mm.  
 Art. 04.119.02 Ø 14



H.850 X L.235 mm. Sinistro/Left  
Art. 04.119.04 ≡ 20 X 6  
H.950 X L.235 mm. Sinistro/Left  
Art. 04.119.06 ≡ 20 X 6



H.850 X L.235 mm. Destro/Right  
Art. 04.119.05 ≡ 20 X 6  
H.950 X L.235 mm. Destro/Right  
Art. 04.119.07 ≡ 20 X 6



Martellato / Hammered  
H.900 X L.380 mm.  
Art. 04.119.08 □ 25 X 25



Martellato / Hammered  
H.750 X L.350 mm.  
Art. 04.119.09 □ 12 mm ≡ 12 X 6  
Art. 04.119.10 □ 14 mm ≡ 12 X 6  
Art. 04.120 □ 16 mm ≡ 16 X 8



Martellato / Hammered  
H.480 X L.220 mm.  
Art. 04.120.01 □ 12 mm ≡ 12 X 6  
Art. 04.120.02 □ 14 mm ≡ 12 X 6  
Art. 04.120.03 □ 16 mm ≡ 16 X 8



Battuto / Wrought  
H.800 X L.305 mm.  
Art. 04.120.04 ≡ 25 X 10



H.700 X L.250 mm.  
Art. 04.120.05 ≡ 20 X 8



H.730 X L.240 mm.  
Art. 04.121 ≡ 20 X 6



Modello Scala / Scala Model  
H.730 X L.240 mm.  
Art. 04.121.01 ≡ 20 X 6



Liscio / Smooth  
H.740 X L.250 mm.  
Art. 04.140 □ 10 mm



Liscio / Smooth  
H.885 X L.265 mm.  
Art. 04.146 ∅ 12 mm  
Art. 04.146.01 ∅ 14 mm  
Art. 04.146.02 ∅ 16 mm



Liscio / Smooth  
H.770 X L.280 mm.  
Art. 04.141 ∅ 25 mm



Rigato / Fluted  
H.550 X L.250 mm.  
Art. 04.142 ≡ 16 X 8



Liscio / Smooth  
H.570 X L.160 mm.  
Art. 04.143 ≡ 14 X 6  
Art. 04.143.01 ≡ 16 X 6

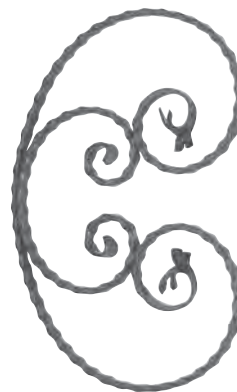

Martellato / Hammered  
H.480 X L.330 mm.  
Art. 04.145 ≡ 18 X 10





Gli articoli della Linea Liberty possono includere particolari in ghisa o ferro fuso.  
*The items of the Liberty Line could contain casting parts.*



H.280 x L.210 mm  
**Art. 04.400** Ø 10 mm  
 Sinistro / Left



H.280 x L.210 mm  
**Art. 04.401** Ø 10 mm  
 Destro / Right



Art. 04.402



Art. 04.403



Martellato / *Hammered*  
 H.400 x L.250 mm  
**Art. 04.404** ≠ 16 X 8 mm  
 Sinistro / Left



Martellato / *Hammered*  
 H.400 x L.250 mm  
**Art. 04.405** ≠ 16 x 8 mm  
 Destro / Right



Martellato / *Hammered*  
 H.450 x L.300 mm  
**Art. 04.406** ≠ 16 x 8 mm  
 Sinistro / Left



Martellato / *Hammered*  
 H.450 x L.300 mm  
**Art. 04.407** ≠ 16 x 8 mm  
 Destro / Right



Martellato / Hammered  
H.500 x L.260 mm  
Art. 04.408 ≠ 16 x 8 mm  
Sinistro / Left



Martellato / Hammered  
H.500 x L.260 mm  
Art. 04.409 ≠ 16 X 8 mm  
Destro / Right



H.370 X L.330 mm.  
Art. 04.500 Ø 12 mm



H.370 X L.330 mm.  
Art. 04.501 Ø 12 mm



H.460 X L.440 mm.  
Art. 04.502 Ø 12 mm



H.460 X L.440 mm.  
Art. 04.503 Ø 12 mm



H.620 X L.410 mm.  
Art. 04.505 Ø 12 mm



H.620 X L.410 mm.  
Art. 04.506 Ø 12 mm



H.970 X L.780 mm.  
Art. 04.507 Ø 12 mm



H.970 X L.780 mm.  
Art. 04.508 Ø 12 mm



H.970 X L.780 mm.  
Art. 04.509 Ø 12 mm



H.970 X L.780 mm.  
Art. 04.510 Ø 12 mm



H.550 x L.750 mm  
Art. 04.516 Ø 12 mm

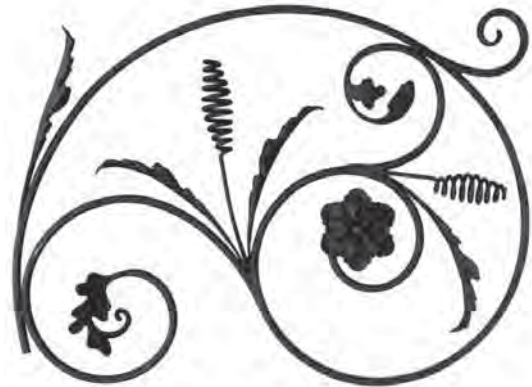

H.550 X L.750 mm.  
Art. 04.517 Ø 12 mm



H.970 X L.420 mm.  
Art. 04.520 Ø 12 mm



H.970 X L.420 mm.  
Art. 04.521 Ø 12 mm



Art. 04.522



Art. 04.523





Rigato / Fluted  
H.715 x L.190 mm  
Art. 04.528  $\approx$  16 x 8 mm  
Sinistro / Left



Rigato / Fluted  
H.715 x L.190 mm  
Art. 04.529  $\approx$  16 x 8 mm  
Destro / Right

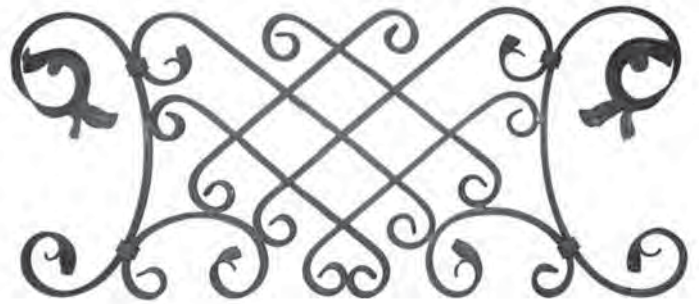

Rigato / Fluted  
H.370 X L.880 mm.  
Art. 04.530  $\approx$  16 X 8



Rigato / Fluted  
H.710 X L.640 mm.  
Art. 04.531  $\approx$  16 X 8

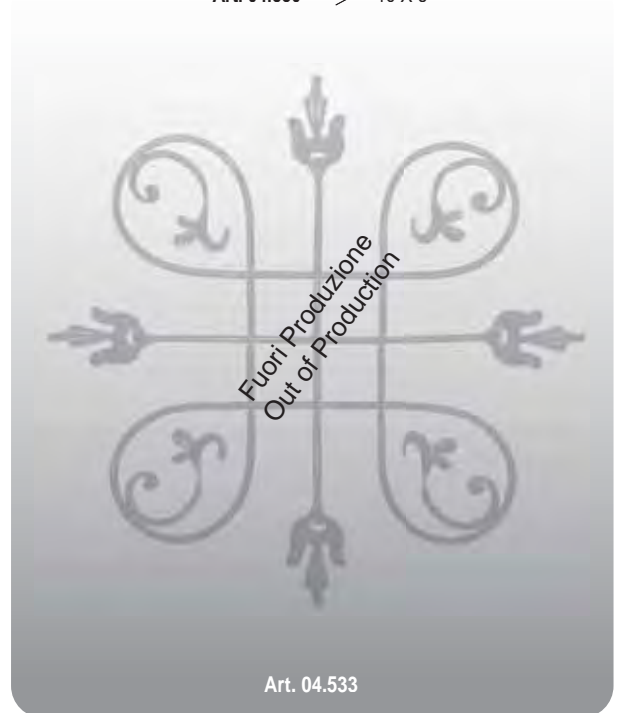

Art. 04.533



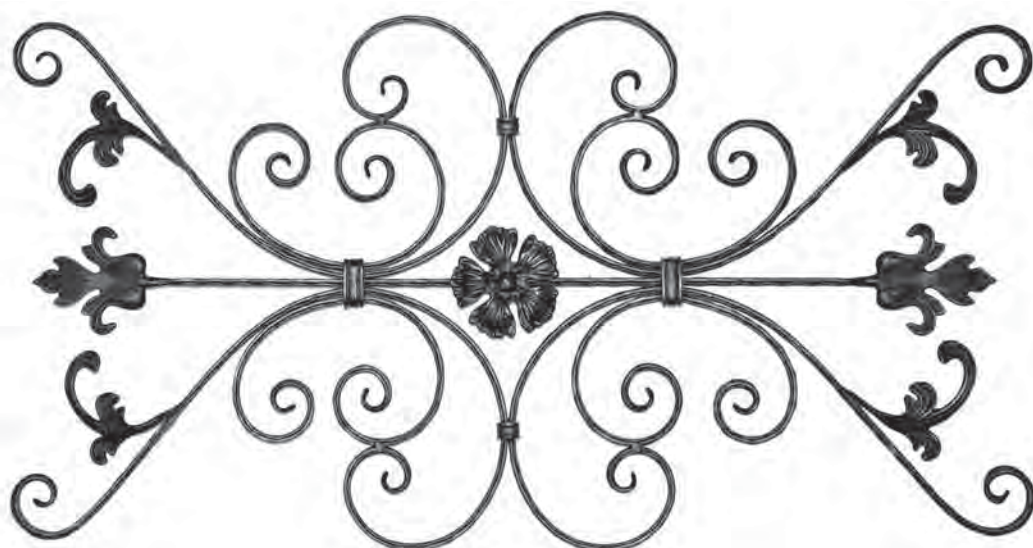

Rigato / Fluted  
H.540 x L.1010 mm  
Art. 04.536  $\neq$  20 X 8 mm



Martellato / Hammered  
H.900 x L.350 mm  
Art. 04.538  $\square$  12 mm



Martellato / Hammered  
H.440 x L.330 mm  
Art. 04.580



Martellato / Hammered  
H.410 x L.370 mm  
Art. 04.581



Tutte le parti di questo catalogo - foto comprese - sono di proprietà Euro-Fer. La riproduzione, anche parziale, è vietata in ogni forma e con ogni mezzo. / Every part of this catalogue - photos included - is Euro-Fer's property. All forms of copying are strictly prohibited.

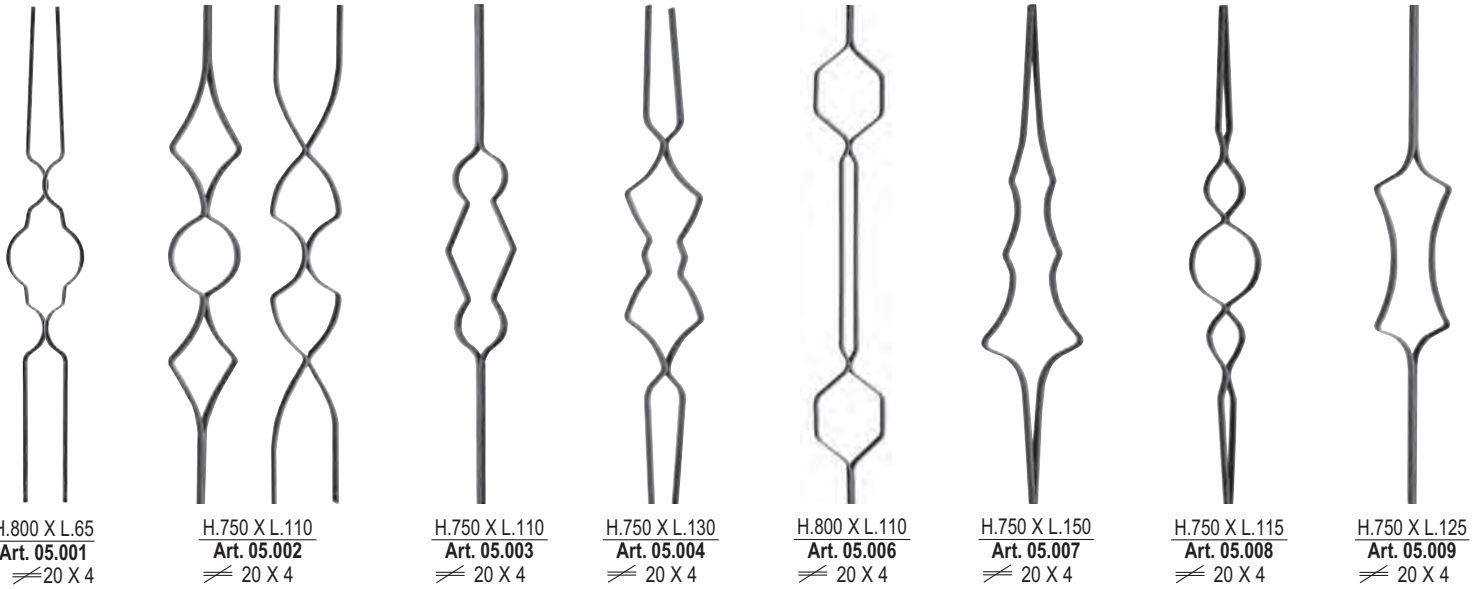

H.800 X L.65  
**Art. 05.001**  
 ≙ 20 X 4

H.750 X L.110  
**Art. 05.002**  
 ≙ 20 X 4

H.750 X L.110  
**Art. 05.003**  
 ≙ 20 X 4

H.750 X L.130  
**Art. 05.004**  
 ≙ 20 X 4

H.800 X L.110  
**Art. 05.006**  
 ≙ 20 X 4

H.750 X L.150  
**Art. 05.007**  
 ≙ 20 X 4

H.750 X L.115  
**Art. 05.008**  
 ≙ 20 X 4

H.750 X L.125  
**Art. 05.009**  
 ≙ 20 X 4

Gli elementi indicati qui sopra sono venduti singolarmente: sono accoppiati a titolo dimostrativo / The elements in the line above are sold separately: they are only in pairs for demonstration purposes

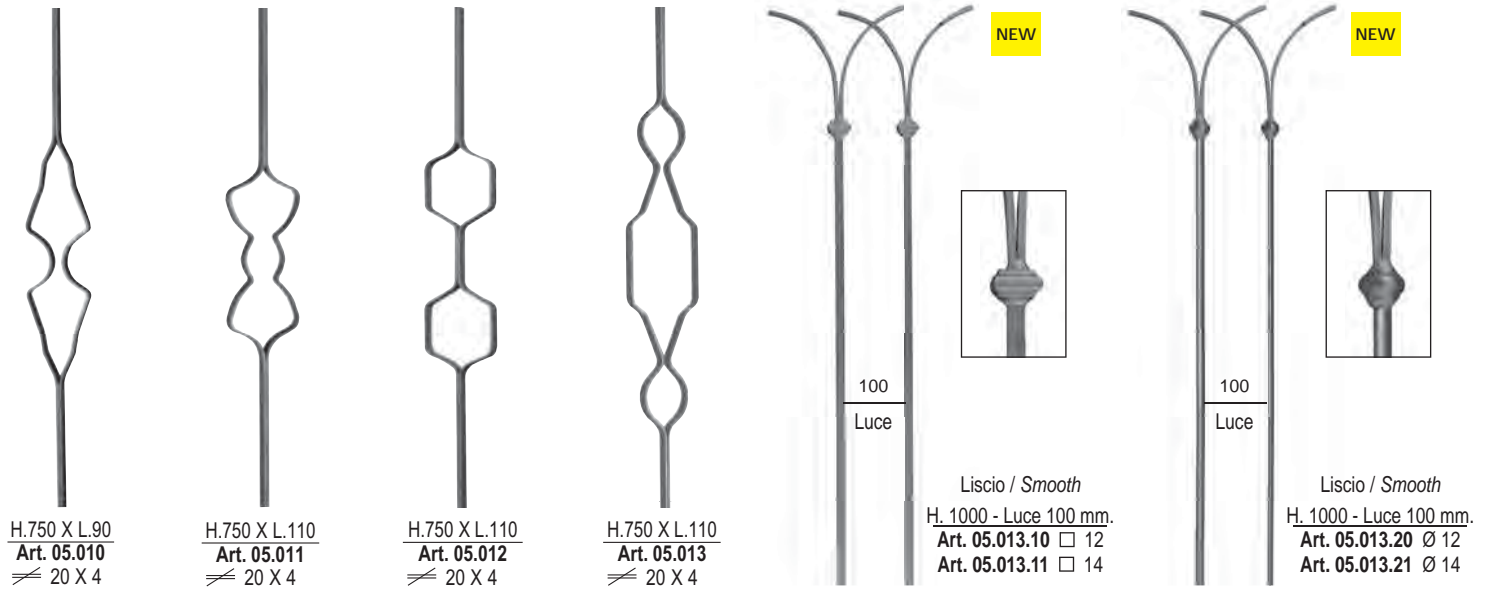

H.750 X L.90  
**Art. 05.010**  
 ≙ 20 X 4

H.750 X L.110  
**Art. 05.011**  
 ≙ 20 X 4

H.750 X L.110  
**Art. 05.012**  
 ≙ 20 X 4

H.750 X L.110  
**Art. 05.013**  
 ≙ 20 X 4

Liscio / Smooth  
 H. 1000 - Luce 100 mm.  
**Art. 05.013.10** □ 12  
**Art. 05.013.11** □ 14

Liscio / Smooth  
 H. 1000 - Luce 100 mm.  
**Art. 05.013.20** Ø 12  
**Art. 05.013.21** Ø 14

Gli elementi indicati qui sopra sono venduti singolarmente: sono accoppiati a titolo dimostrativo / The elements in the line above are sold separately: they are only in pairs for demonstration purposes

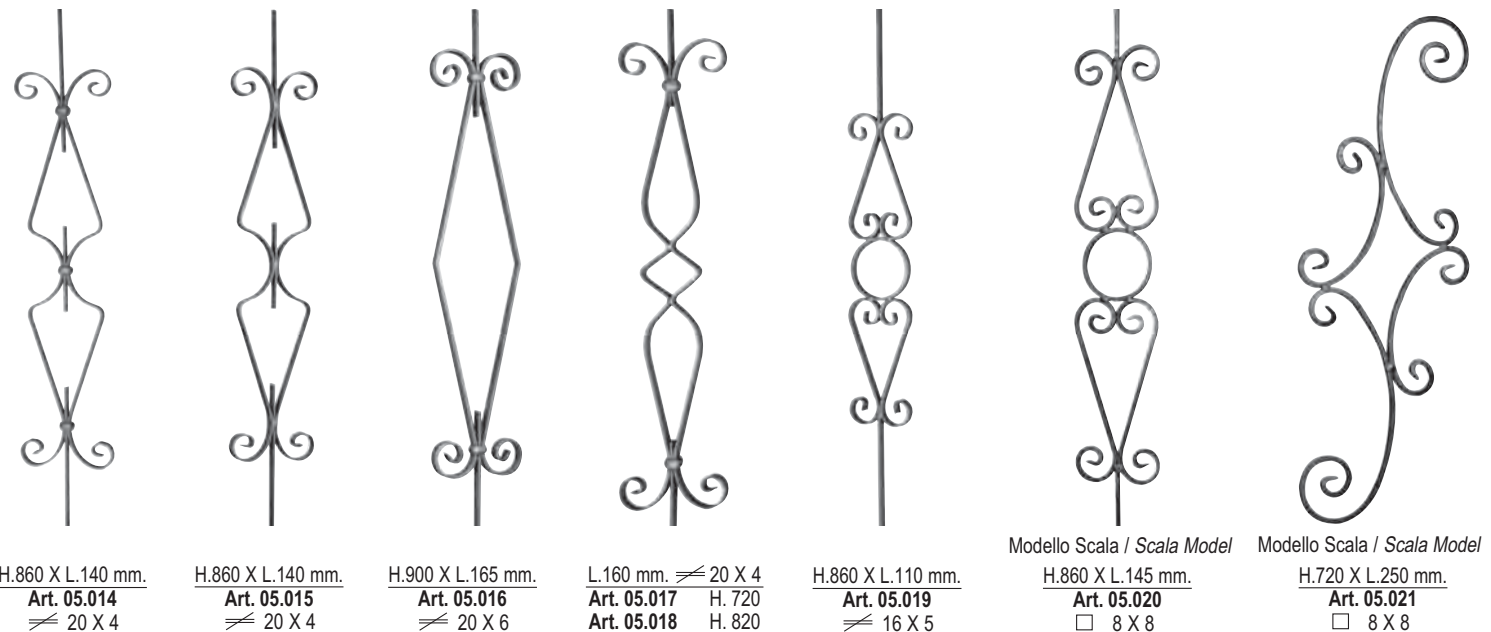

H.860 X L.140 mm.  
**Art. 05.014**  
 ≙ 20 X 4

H.860 X L.140 mm.  
**Art. 05.015**  
 ≙ 20 X 4

H.900 X L.165 mm.  
**Art. 05.016**  
 ≙ 20 X 6

L.160 mm. ≙ 20 X 4  
**Art. 05.017** H. 720  
**Art. 05.018** H. 820

H.860 X L.110 mm.  
**Art. 05.019**  
 ≙ 16 X 5

Modello Scala / Scala Model  
 H.860 X L.145 mm.  
**Art. 05.020**  
 □ 8 X 8

Modello Scala / Scala Model  
 H.720 X L.250 mm.  
**Art. 05.021**  
 □ 8 X 8

Tutte le parti di questo catalogo - foto comprese - sono di proprietà Euro-Fer. La riproduzione, anche parziale, è vietata in ogni forma e con ogni mezzo. / Every part of this catalogue - photos included - is Euro-Fer's property. All forms of copying are strictly prohibited.





H.720 X L.250 mm.  
Art. 05.023  
≠ 16 X 4



Tondo / Round  
H.870 X L.260 mm.  
Art. 05.023.01  
Ø 12



H.720 X L.250 mm.  
Art. 05.024  
≠ 16 X 4



H.720 X L.250 mm.  
Art. 05.025  
≠ 16 X 4

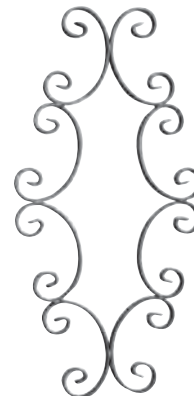

H.540 X L.250 mm.  
Art. 05.026  
≠ 16 X 4

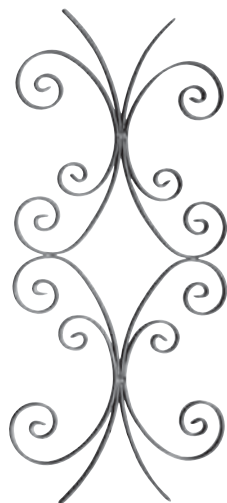

H.720 X L.330 mm.  
Art. 05.028  
≠ 16 X 4



Ferro Spigolato  
Edged Bar  
H.950 X L.125 mm.  
Art. 05.029  
□ 14 X 14

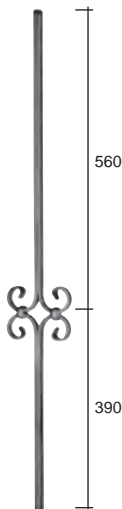

Ferro Spigolato  
Edged Bar  
H.950 X L.125 mm.  
Art. 05.030  
□ 14 X 14



Ferro Spigolato  
Edged Bar  
H.950 X L.125 mm.  
Art. 05.031  
□ 14 X 14



H.750 X L.200 mm.  
Art. 05.032  
3 ≠ 16 X 4



H.750 X L.200 mm.  
Art. 05.033  
3 ≠ 16 X 4



H.750 X L.200 mm.  
Art. 05.034  
4 ≠ 16 X 4



H.750 X L.200 mm.  
Art. 05.035  
4 ≠ 16 X 4



H.750 X L.200 mm.  
Art. 05.036  
3 ≠ 16 X 4



H.750 X L.200 mm.  
Art. 05.037  
3 ≠ 16 X 4



H.750 mm.  
Art. 05.038 ≠ 16 X 4  
Art. 05.039 ≠ 20 X 4



H.950 mm.  
Art. 05.043.01  
≠ 20 X 6

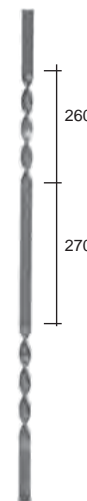

H.950 mm.  
Art. 05.043.02  
≠ 20 X 6

H.850 mm.  
Art. 05.040 ≠ 16 X 4  
Art. 05.041 ≠ 20 X 4

H.900 mm.  
Art. 05.042 ≠ 16 X 4  
Art. 05.043 ≠ 20 X 4

Tutte le parti di questo catalogo - foto comprese - sono di proprietà Euro-Fer. La riproduzione, anche parziale, è vietata in ogni forma e con ogni mezzo. / Every part of this catalogue - photos included - is Euro-Fer's property. All forms of copying are strictly prohibited.

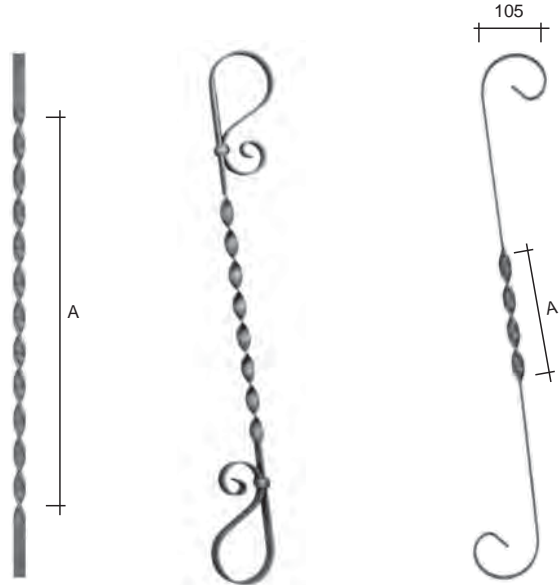

H.720 mm.  
**Art. 05.043.03**  
≠ 20 X 6  
A = 550 mm.  
H.950 mm.  
**Art. 05.043.04**  
≠ 20 X 6  
A = 700 mm.

H.730 X L.90 mm.  
**Art. 05.044**  
≠ 20 X 4

H.350 mm. - A = 100 mm.  
**Art. 05.044.01** ≠ 20 X 5  
H.650 mm. - A = 220 mm.  
**Art. 05.044.02** ≠ 20 X 5  
H.850 mm. - A = 220 mm.  
**Art. 05.044.03** ≠ 20 X 5  
H.950 mm. - A = 220 mm.  
**Art. 05.044.04** ≠ 20 X 5



H.950 mm.  
**Art. 05.045** □12  
**Art. 05.045.01** □14  
**Art. 05.045.02** □16



H.950 mm.  
**Art. 05.046** □12  
**Art. 05.046.01** □14  
**Art. 05.046.02** □16



H.750 mm.  
**Art. 05.047** □8  
**Art. 05.048** □10  
**Art. 05.049** □12  
**Art. 05.050** □14  
**Art. 05.051** □16



H.950 mm.  
**Art. 05.062** □12



H.950 mm.  
**Art. 05.063** □12



H.950 X L.110 mm.  
**Art. 05.064**  
□12 ≠ 12 X 4



H.950 X L.165 mm.  
**Art. 05.065**  
□12 ≠ 12 X 6



H.950 X L.165 mm.  
**Art. 05.066**  
□12 ≠ 12 X 6

H.1200 mm.  
**Art. 05.045.03** □12  
**Art. 05.045.04** □14  
**Art. 05.045.05** □16

H.1500 mm.  
**Art. 05.045.06** □12  
**Art. 05.045.07** □14  
**Art. 05.045.08** □16

H.850 mm.  
**Art. 05.052** □8  
**Art. 05.053** □10  
**Art. 05.054** □12  
**Art. 05.055** □14  
**Art. 05.056** □16

H.950 mm.  
**Art. 05.057** □8  
**Art. 05.058** □10  
**Art. 05.059** □12  
**Art. 05.060** □14  
**Art. 05.061** □16



**PANNELLI LISCI E PALETTI PER RECINZIONI**  
**PLAIN PANEL UNITS AND STAKES FOR FENCES**



H.950 X L.170 mm.  
**Art. 05.067**  
 □12 ≄12 X 6



H.950 X L.170 mm.  
**Art. 05.068**  
 □12 ≄12 X 6



H.950 X L.110 mm.  
**Art. 05.069**  
 □12 ≄12 X 6



H.950 X L.140 mm.  
**Art. 05.070**  
 □12 ≄12 X 6



H.950 X L.140 mm.  
**Art. 05.071**  
 □12 ≄12 X 6



H.950 X L.155 mm.  
**Art. 05.071.01**  
 □12 ≄12 X 6

H.950 X L.155 mm.  
**Art. 05.071.02**  
 □14 ≄14 X 6



H.950 X L.155 mm.  
**Art. 05.071.03**  
 □12 ≄12 X 6

H.950 X L.155 mm.  
**Art. 05.071.04**  
 □14 ≄14 X 6



H.950 X L.220 mm.  
**Art. 05.072**  
 □12 ≄12 X 6



H.950 X L.180 mm.  
**Art. 05.073**  
 □12 ≄12 X 6



H.950 X L.220 mm.  
**Art. 05.074**  
 □12 ≄12 X 6



H.950 X L.170 mm.  
**Art. 05.075**  
 □12 ≄12 X 6



H.950 X L.180 mm.  
**Art. 05.076**  
 □12 ≄12 X 6



H.1200 X L.185 mm  
**Art. 05.076.01**  
 □16 ≄16 X 4



H.950 x L.180 mm  
**Art. 05.076.02**  
 □12 mm ≄12 x 6



H.950 X L.220 mm.  
**Art. 05.077**  
 □12 ≄12 X 6



H.950 X L.240 mm.  
**Art. 05.078**  
 □12 ≄12 X 6



H.950 X L.150 mm.  
**Art. 05.079**  
 □12 ≄12 X 6



H.950 X L.220 mm.  
**Art. 05.080**  
 □12 ≄12 X 6



H.950 X L.150 mm.  
**Art. 05.081**  
 □12 ≄12 X 6



H.950 x L.100 mm  
**Art. 05.081.50** □14



H.950 X L.220 mm.  
**Art. 05.082**  
 □12 ≄12 X 6

Tutte le parti di questo catalogo - foto comprese - sono di proprietà Euro-Fer. La riproduzione, anche parziale, è vietata in ogni forma e con ogni mezzo. / Every part of this catalogue - photos included - is Euro-Fer's property. All forms of copying are strictly prohibited.





H.950 X L.210 mm.  
**Art. 05.083**  
 □12 ≙12 X 4

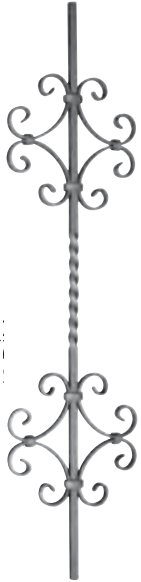

H.950 X L.210 mm.  
**Art. 05.084**  
 □12 ≙12 X 4



H.950 X L.270 mm.  
**Art. 05.085**  
 □12 ≙12 X 6

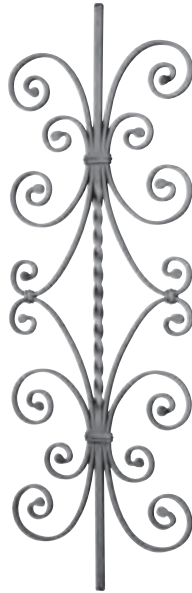

H.950 X L.300 mm.  
**Art. 05.086**  
 □12 ≙12 X 6



H.950 X L.220 mm.  
**Art. 05.087**  
 □12 ≙12 X 6



H.950 X L.275 mm.  
**Art. 05.088**  
 □12 ≙12 X 6



H.950 X L.180 mm.  
**Art. 05.088.01**  
 □12 ≙12 X 6



H.950 X L.220 mm.  
**Art. 05.089**  
 □12 ≙12 X 6



**NEW**



Liscio / Smooth  
 H. 950 X L. 72 mm.  
**Art. 05.089.10**  
 □ 12

**NEW**



Liscio / Smooth  
 H. 950 X L. 72 mm.  
**Art. 05.089.11**  
 □ 12

PANNELLI LISCI E PALETTI PER RECINZIONI  
PLAIN PANEL UNITS AND STAKES FOR FENCES



H.950 X L.190 mm.  
Art. 05.090  
□12 ≙ 12 X 6



H.950 X L.190 mm.  
Art. 05.091  
□12 ≙ 12 X 6



H.950 X L.100 mm.  
Art. 05.092  
≙ 40 X 4



H.950 X L.100 mm.  
Art. 05.093  
≙ 40 X 4



Tondo / Round  
H.950 X L.130 mm.  
Art. 05.094 ØØ12



Tondo / Round  
H.950 X L.130 mm.  
Art. 05.094.01 ØØ12



Tondo / Round  
H.950 X L.130 mm.  
Art. 05.094.02 ØØ12



Tondo / Round  
H.950 X L.270 mm.  
Art. 05.094.03 ØØ12



Tondo / Round  
H.900 X L.360 mm.  
Art. 05.094.04 Ø14



Tondo / Round  
H.900 X L.360 mm.  
Art. 05.094.05 Ø14



H.950 X L.125 mm.  
Art. 05.095 □ 12



H.800 X L.100 mm.  
Art. 05.096 □ 8  
Art. 05.097 □ 10



H.800 X L.100 mm.  
Art. 05.100 □ 8  
Art. 05.101 □ 10



H.800 X L.160 mm.  
Art. 05.104 □ 8  
H.950 X L.160 mm.  
Art. 05.105 □ 8

H.950 X L.100 mm.  
Art. 05.098 □ 8  
Art. 05.099 □ 10

H.950 X L.100 mm.  
Art. 05.102 □ 8  
Art. 05.103 □ 10



H.800 X L.110 mm.  
Art. 05.106 □ 10



H.800 X L.200 mm.  
Art. 05.107 □ 8



H.800 X L.260 mm.  
Art. 05.108 □ 8



H.800 X L.140 mm.  
Art. 05.109 □ 8  
H.950 X L.140 mm.  
Art. 05.110 □ 8



H.800 X L.200 mm.  
Art. 05.111 □ 8  
H.950 X L.200 mm.  
Art. 05.112 □ 8



H.800 X L.140 mm.  
Art. 05.113 □ 8  
H.950 X L.140 mm.  
Art. 05.114 □ 8



H.950 X L.240 mm.  
Art. 05.115  
□12 ≙ 12 X 6

Tutte le parti di questo catalogo - foto comprese - sono di proprietà Euro-Fer. La riproduzione, anche parziale, è vietata in ogni forma e con ogni mezzo. / Every part of this catalogue - photos included - is Euro-Fer's property. All forms of copying are strictly prohibited.



H.950 X L.160 mm.  
**Art. 05.116**  
□ 12 ≠ 12 X 6



H.820 X L.215 mm.  
**Art. 05.117** □ 8  
H.950 X L.215 mm.  
**Art. 05.118** □ 8



H.820 X L.205 mm.  
**Art. 05.119** □ 8  
H.950 X L.205 mm.  
**Art. 05.120** □ 8



**Art. 05.121**



**Art. 05.122**



Rigato / Fluted  
H.950 x L.240 mm  
**Art. 05.122.50**  
□ 12 mm ≠ 12 x 6



Rigato / Fluted  
H.950 x L.240 mm  
**Art. 05.122.51**  
□ 12 mm ≠ 12 x 6



.ES = "Modello España"  
.ES = "España Model"

190

190

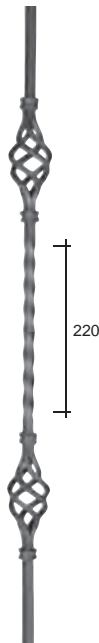

220

Liscio / Smooth  
H.950 mm  
**Art. 05.123** □ 12 mm  
**Art. 05.123.01** □ 14 mm  
**Art. 05.123.ES** □ 12 mm  
**Art. 05.123.01.ES** □ 14 mm  
**Art. 05.123.02** □ 16 mm  
**Art. 05.123.02.ES** □ 16 mm

Liscio / Smooth  
H.950 mm  
**Art. 05.124** □ 12 mm  
**Art. 05.124.01** □ 14 mm  
**Art. 05.124.ES** □ 12 mm  
**Art. 05.124.01.ES** □ 14 mm  
**Art. 05.124.06** □ 16 mm  
**Art. 05.124.06.ES** □ 16 mm

Liscio / Smooth  
H.950 mm  
**Art. 05.124.02** □ 12 mm  
H.950 mm  
**Art. 05.124.03** □ 14 mm  
H.950 mm  
**Art. 05.124.07** □ 16 mm

Liscio / Smooth  
H.950 mm  
**Art. 05.124.04** □ 12 mm  
H.950 mm  
**Art. 05.124.05** □ 14 mm  
H.950 mm  
**Art. 05.124.08** □ 16 mm

H.950 X L.150 mm.  
**Art. 05.125**  
□ 12 ≠ 12 X 6

H.950 X L.150 mm.  
**Art. 05.126**  
□ 12 ≠ 12 X 6

H.950 X L.220 mm.  
**Art. 05.127**  
□ 12 ≠ 12 X 6



**PANNELLI LISCI E PALETTI PER RECINZIONI**  
**PLAIN PANEL UNITS AND STAKES FOR FENCES**



H.950 X L.140 mm.  
**Art. 05.128**  
 □ 12 ≧ 12 X 6



H.950 X L.205 mm.  
**Art. 05.129**  
 □ 12 ≧ 12 X 6



H.950 X L.170 mm.  
**Art. 05.130**  
 □ 12 ≧ 12 X 6



H.950 X L.170 mm.  
**Art. 05.131**  
 □ 12 ≧ 12 X 6



H.950 X L.230 mm.  
**Art. 05.132**  
 □ 12 ≧ 12 X 6



H.950 X L.185 mm.  
**Art. 05.133**  
 □ 12 ≧ 12 X 6



H.950 X L.215 mm.  
**Art. 05.134**  
 □ 12 ≧ 12 X 6



H.950 X L.215 mm.  
**Art. 05.135**  
 □ 12 ≧ 12 X 6



H.950 X L.215 mm.  
**Art. 05.136**  
 □ 12 ≧ 12 X 6



Liscio / Smooth  
 H.950 x L.235 mm  
**Art. 05.136.01**  
 □ 12 mm ≧ 12 x 6 mm





H.950 X L.250 mm.  
**Art. 05.137**  
 □ 12 ≙ 12 X 6



H.950 X L.250 mm.  
**Art. 05.138**  
 □ 12 ≙ 12 X 6



H.950 X L.170 mm.  
**Art. 05.139**  
 □ 12 ≙ 12 X 6



H.950 X L.170 mm.  
**Art. 05.140**  
 □ 12 ≙ 12 X 6



H.950 X L.260 mm.  
**Art. 05.141**  
 □ 12 ≙ 12 X 6  
**Art. 05.141.02**  
 □ 14 ≙ 14 X 6



H.950 X L.230 mm.  
**Art. 05.141.01**  
 □ 12 ≙ 12 X 6  
**Art. 05.141.03**  
 □ 14 ≙ 14 X 6



Liscio / Smooth  
 H.950 x L.280 mm  
**Art. 05.141.04**  
 □ 12 ≙ 12 x 6



H.860 X L.350 mm.  
**Art. 05.142** ≙ 12 X 6  
**Art. 05.142.04** ≙ 14 X 6  
**Art. 05.142.05** ≙ 16 X 8  
 Mod. Scala / *Scala Model*  
**Art. 05.142.06** ≙ 12 X 6  
**Art. 05.142.07** ≙ 14 X 6  
**Art. 05.142.08** ≙ 16 X 8



H.860 X L.350 mm.  
**Art. 05.142.01** ≙ 12 X 6  
**Art. 05.142.09** ≙ 14 X 6  
**Art. 05.142.10** ≙ 16 X 8  
 Mod. Scala / *Scala Model*  
**Art. 05.142.11** ≙ 12 X 6  
**Art. 05.142.12** ≙ 14 X 6  
**Art. 05.142.13** ≙ 16 X 8



H.950 X L.175 mm.  
**Art. 05.142.02** □ 12  
 H.950 X L.175 mm.  
**Art. 05.142.03** □ 14



Fuori Produzione  
 Out of Production

**Art. 05.143**



PANNELLI LISCI E PALETTI PER RECINZIONI  
PLAIN PANEL UNITS AND STAKES FOR FENCES



H.950 X L.260 mm.  
Art. 05.144  
□ 12 ≧ 12 X 6



Art. 05.145



H.950 X L.260 mm.  
Art. 05.146  
□ 12 ≧ 12 X 6



Art. 05.147



H.950 X L.290 mm.  
Art. 05.148  
□ 12 ≧ 12 X 6



H.950 X L.205 mm.  
Art. 05.149  
□ 12 ≧ 12 X 6



H.950 X L.140 mm.  
Art. 05.149.01  
□ 12 ≧ 12 X 6



H.950 X L.190 mm.  
Art. 05.150  
□ 12 ≧ 12 X 6



H.950 X L.145 mm.  
Art. 05.150.01  
□ 12 ≧ 12 X 6  
Art. 05.150.02  
□ 14 ≧ 14 X 6



H.950 X L.95 mm.  
Art. 05.151  
□ 12 ≧ 12 X 6



H.950 X L.210 mm.  
Art. 05.152  
□ 12 ≧ 12 X 6



H.950 X L.150 mm.  
Art. 05.152.01 □ 8



H.950 X L.205 mm.  
Art. 05.153  
□ 12 ≧ 12 X 6

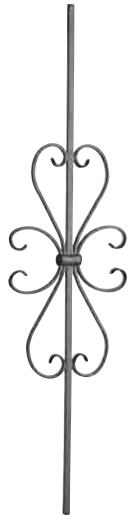

H.950 X L.225 mm.  
Art. 05.153.01  
□ 12 ≧ 12 X 6



H.950 X L.220 mm.  
Art. 05.154  
□ 12 ≧ 12 X 6



H.950 X L.230 mm.  
Art. 05.154.01  
□ 12 ≧ 12 X 6  
Art. 05.154.08  
□ 14 ≧ 14 X 6



H.950 X L.185 mm.  
Art. 05.154.02  
□ 14 ≧ 14 X 6



H.950 X L.200 mm.  
Art. 05.154.03  
□ 12 ≧ 12 X 6  
Art. 05.154.09  
□ 14 ≧ 14 X 6



H.950 X L.220 mm.  
Art. 05.154.04  
□ 12 ≧ 12 X 6  
Art. 05.154.10  
□ 16 ≧ 16 X 8



H.950 X L.205 mm.  
Art. 05.154.05  
□ 12 ≧ 12 X 6  
Art. 05.154.11  
□ 16 ≧ 16 X 8



H.950 X L.245 mm.  
Art. 05.154.06  
□ 12 ≧ 12 X 6

Tutte le parti di questo catalogo - foto comprese - sono di proprietà Euro-Fer. La riproduzione, anche parziale, è vietata in ogni forma e con ogni mezzo. / Every part of this catalogue - photos included - is Euro-Fer's property. All forms of copying are strictly prohibited.





H.830 X L.280 mm.  
Art. 05.154.07  
≠ 16 X 6



Martellato / *Hampered*  
H.950 x L.170 mm  
Art. 05.154.12  
□ 12 ≠ 12 x 6 mm



Rigato / *Fluted*  
H.950 x L.240 mm  
Art. 05.154.13  
≠ 16 x 8 mm



Rigato / *Fluted*  
H.950 x L.360 mm  
Art. 05.154.14  
□ 16 ≠ 16 x 8 mm

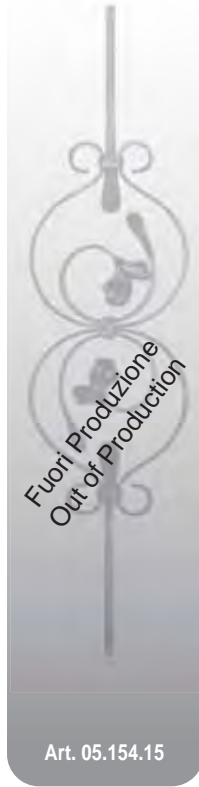

Art. 05.154.15



Liscio / *Smooth*  
H.900 x L.275 mm  
Art. 05.154.16  
≠ 20 x 6 mm



Rigato / *Fluted*  
H.950 x L.190 mm  
Art. 05.154.17  
≠ 16 x 8 mm



Martellato / *Hampered*  
H.950 x L.230 mm  
Art. 05.154.18  
≠ 16 x 8 mm



Martellato / *Hampered*  
H.950 x L.230 mm  
Art. 05.154.19  
≠ 16 x 8 mm



Liscio / *Smooth*  
H.950 x L.180 mm  
Art. 05.154.20 □ 12 mm  
Con fiori su ambo i lati /  
*Flowers on both sides*



Liscio / *Smooth*  
H.950 mm

- Art. 05.154.100 □ 12 mm
- Art. 05.154.101 □ 14 mm
- Art. 05.154.102 □ 16 mm
- Art. 05.154.103 □ 18 mm
- Art. 05.154.104 □ 20 mm



Liscio / *Smooth*  
H.950 mm

- Art. 05.154.200 Ø 12 mm
- Art. 05.154.201 Ø 14 mm
- Art. 05.154.202 Ø 16 mm
- Art. 05.154.203 Ø 18 mm
- Art. 05.154.204 Ø 20 mm



## PANNELLI LISCI E PALETTI PER RECINZIONI PLAIN PANEL UNITS AND STAKES FOR FENCES

← Punta a matita /  
Pencil Point

← Punta a piramide →  
Pyramid Point

Tondo / Round

H.950 mm.

Art. 05.155 Ø 12  
Art. 05.156 Ø 14  
Art. 05.157 Ø 16  
Art. 05.158 Ø 18  
Art. 05.159 Ø 20

H.1000 mm.

Art. 05.160 Ø 12  
Art. 05.161 Ø 14  
Art. 05.162 Ø 16  
Art. 05.163 Ø 18  
Art. 05.164 Ø 20

H.1200 mm.

Art. 05.165 Ø 12  
Art. 05.166 Ø 14  
Art. 05.167 Ø 16  
Art. 05.168 Ø 18  
Art. 05.169 Ø 20

H.1500 mm.

Art. 05.170 Ø 12  
Art. 05.171 Ø 14  
Art. 05.172 Ø 16  
Art. 05.173 Ø 18  
Art. 05.174 Ø 20

H.950 mm.

Art. 05.175 □ 12  
Art. 05.176 □ 14  
Art. 05.177 □ 16  
Art. 05.178 □ 18  
Art. 05.179 □ 20  
Art. 05.180 □ 25  
Art. 05.181 □ 30  
Art. 05.182 □ 35  
Art. 05.183 □ 40

H.1200 mm.

Art. 05.193 □ 12  
Art. 05.194 □ 14  
Art. 05.195 □ 16  
Art. 05.196 □ 18  
Art. 05.197 □ 20  
Art. 05.198 □ 25  
Art. 05.199 □ 30  
Art. 05.200 □ 35  
Art. 05.201 □ 40

H.1000 mm.

Art. 05.184 □ 12  
Art. 05.185 □ 14  
Art. 05.186 □ 16  
Art. 05.187 □ 18  
Art. 05.188 □ 20  
Art. 05.189 □ 25  
Art. 05.190 □ 30  
Art. 05.191 □ 35  
Art. 05.192 □ 40

H.1500 mm.

Art. 05.202 □ 12  
Art. 05.203 □ 14  
Art. 05.204 □ 16  
Art. 05.205 □ 18  
Art. 05.206 □ 20  
Art. 05.207 □ 25  
Art. 05.208 □ 30  
Art. 05.209 □ 35  
Art. 05.210 □ 40

Martellato / Hammered

H.950 mm.

Art. 05.211 □ 12  
Art. 05.212 □ 14  
Art. 05.213 □ 16  
Art. 05.214 □ 18  
Art. 05.215 □ 20

H.1000 mm.

Art. 05.216 □ 12  
Art. 05.217 □ 14  
Art. 05.218 □ 16  
Art. 05.219 □ 18  
Art. 05.220 □ 20

H.1200 mm.

Art. 05.221 □ 12  
Art. 05.222 □ 14  
Art. 05.223 □ 16  
Art. 05.224 □ 18  
Art. 05.225 □ 20

H.1500 mm.

Art. 05.226 □ 12  
Art. 05.227 □ 14  
Art. 05.228 □ 16  
Art. 05.229 □ 18  
Art. 05.230 □ 20

Tubo / Tube

H.900 x L.140 mm

Art. 05.229.01 Ø 20 mm

H.1150 x L.140 mm

Art. 05.229.02 Ø 20 mm

H.1475 x L.140 mm

Art. 05.229.03 Ø 20 mm

H.1800 x L.140 mm

Art. 05.229.04 Ø 20 mm

206

Pieno / Solid

H.1000 X L.124 mm.

Art. 05.230.01 Ø 12

H.1000 X L.128 mm.

Art. 05.230.02 Ø 14

H.1000 X L.124 mm.

Art. 05.230.03 □ 12

H.1000 X L.128 mm.

Art. 05.230.04 □ 14

Pieno / Solid

H.1000 X L.230 mm.

Art. 05.230.05 □ 12

H.1000 X L.234 mm.

Art. 05.230.06 □ 14

H.1000 X L.230 mm.

Art. 05.230.07 Ø 12

H.1000 X L.234 mm.

Art. 05.230.08 Ø 14

Palline Grandi / Large Balls



Martellato / Hammered

H.950 mm.

Art. 05.230.09 □ 12  
Art. 05.230.10 □ 14  
Art. 05.230.11 □ 16  
Art. 05.230.12 □ 18

H.1000 mm.

Art. 05.230.13 □ 12  
Art. 05.230.14 □ 14  
Art. 05.230.15 □ 16  
Art. 05.230.16 □ 18

H.1200 mm.

Art. 05.230.17 □ 12  
Art. 05.230.18 □ 14  
Art. 05.230.19 □ 16  
Art. 05.230.20 □ 18

H.1500 mm.

Art. 05.230.21 □ 12  
Art. 05.230.22 □ 14  
Art. 05.230.23 □ 16  
Art. 05.230.24 □ 18

H.950 mm.

Art. 05.230.25 □ 12  
Art. 05.230.26 □ 14  
Art. 05.230.27 □ 16  
Art. 05.230.28 □ 18

H.1000 mm.

Art. 05.230.29 □ 12  
Art. 05.230.30 □ 14  
Art. 05.230.31 □ 16  
Art. 05.230.32 □ 18

H.1200 mm.

Art. 05.230.33 □ 12  
Art. 05.230.34 □ 14  
Art. 05.230.35 □ 16  
Art. 05.230.36 □ 18

H.1500 mm.

Art. 05.230.37 □ 12  
Art. 05.230.38 □ 14  
Art. 05.230.39 □ 16  
Art. 05.230.40 □ 18

Tondo / Round

H.950 mm.

Art. 05.230.41 Ø 12  
Art. 05.230.42 Ø 14  
Art. 05.230.43 Ø 16  
Art. 05.230.44 Ø 18

H.1000 mm.

Art. 05.230.45 Ø 12  
Art. 05.230.46 Ø 14  
Art. 05.230.47 Ø 16  
Art. 05.230.48 Ø 18

H.1200 mm.

Art. 05.230.49 Ø 12  
Art. 05.230.50 Ø 14  
Art. 05.230.51 Ø 16  
Art. 05.230.52 Ø 18

H.1500 mm.

Art. 05.230.53 Ø 12  
Art. 05.230.54 Ø 14  
Art. 05.230.55 Ø 16  
Art. 05.230.56 Ø 18

H.950 mm.

Art. 05.230.57 □ 12  
Art. 05.230.58 □ 14  
Art. 05.230.59 □ 16  
Art. 05.230.60 □ 18

H.1000 mm.

Art. 05.230.61 □ 12  
Art. 05.230.62 □ 14  
Art. 05.230.63 □ 16  
Art. 05.230.64 □ 18

H.1200 mm.

Art. 05.230.65 □ 12  
Art. 05.230.66 □ 14  
Art. 05.230.67 □ 16  
Art. 05.230.68 □ 18

H.1500 mm.

Art. 05.230.69 □ 12  
Art. 05.230.70 □ 14  
Art. 05.230.71 □ 16  
Art. 05.230.72 □ 18





Fascetta inserita a caldo / Hot-inserted clip



Martellato / Hammered

H.950 mm.	
Art. 05.230.73	□ 14
Art. 05.230.74	□ 16
H.1000 mm.	
Art. 05.230.75	□ 14
Art. 05.230.76	□ 16
H.1200 mm.	
Art. 05.230.77	□ 14
Art. 05.230.78	□ 16
H.1500 mm.	
Art. 05.230.79	□ 14
Art. 05.230.80	□ 16
H.2000 mm.	
Art. 05.230.81	□ 14
Art. 05.230.82	□ 16

H.950 mm.	
Art. 05.230.83	□ 14
Art. 05.230.84	□ 16
H.1000 mm.	
Art. 05.230.85	□ 14
Art. 05.230.86	□ 16
H.1200 mm.	
Art. 05.230.87	□ 14
Art. 05.230.88	□ 16
H.1500 mm.	
Art. 05.230.89	□ 14
Art. 05.230.90	□ 16
H.2000 mm.	
Art. 05.230.91	□ 14
Art. 05.230.92	□ 16

Tondo / Round

H.950 mm.	
Art. 05.230.93	Ø14
Art. 05.230.94	Ø16
H.1000 mm.	
Art. 05.230.95	Ø14
Art. 05.230.96	Ø16
H.1200 mm.	
Art. 05.230.97	Ø14
Art. 05.230.98	Ø16
H.1500 mm.	
Art. 05.230.99	Ø14
Art. 05.230.100	Ø16
H.2000 mm.	
Art. 05.230.101	Ø14
Art. 05.230.102	Ø16

Martellato / Hammered

H.950 mm.	
Art. 05.230.103	□ 14
Art. 05.230.104	□ 16
H.1000 mm.	
Art. 05.230.105	□ 14
Art. 05.230.106	□ 16
H.1200 mm.	
Art. 05.230.107	□ 14
Art. 05.230.108	□ 16
H.1500 mm.	
Art. 05.230.109	□ 14
Art. 05.230.110	□ 16
H.2000 mm.	
Art. 05.230.111	□ 14
Art. 05.230.112	□ 16

H.950 mm.	
Art. 05.230.113	□ 14
Art. 05.230.114	□ 16
H.1000 mm.	
Art. 05.230.115	□ 14
Art. 05.230.116	□ 16
H.1200 mm.	
Art. 05.230.117	□ 14
Art. 05.230.118	□ 16
H.1500 mm.	
Art. 05.230.119	□ 14
Art. 05.230.120	□ 16
H.2000 mm.	
Art. 05.230.121	□ 14
Art. 05.230.122	□ 16

Tondo / Round

H.950 mm.	
Art. 05.230.123	Ø14
Art. 05.230.124	Ø16
H.1000 mm.	
Art. 05.230.125	Ø14
Art. 05.230.126	Ø16
H.1200 mm.	
Art. 05.230.127	Ø14
Art. 05.230.128	Ø16
H.1500 mm.	
Art. 05.230.129	Ø14
Art. 05.230.130	Ø16
H.2000 mm.	
Art. 05.230.131	Ø14
Art. 05.230.132	Ø16



Martellato / Hammered

H.1000 mm.	
Art. 05.230.133	□ 14
Art. 05.230.134	□ 16
Art. 05.230.135	□ 18
H.1200 mm.	
Art. 05.230.136	□ 14
Art. 05.230.137	□ 16
Art. 05.230.138	□ 18
H.1500 mm.	
Art. 05.230.139	□ 14
Art. 05.230.140	□ 16
Art. 05.230.141	□ 18

H.1000 mm.	
Art. 05.230.142	□ 14
Art. 05.230.143	□ 16
Art. 05.230.144	□ 18
H.1200 mm.	
Art. 05.230.145	□ 14
Art. 05.230.146	□ 16
Art. 05.230.147	□ 18
H.1500 mm.	
Art. 05.230.148	□ 14
Art. 05.230.149	□ 16
Art. 05.230.150	□ 18

Tondo / Round

H.1000 mm.	
Art. 05.230.151	Ø14
Art. 05.230.152	Ø16
Art. 05.230.153	Ø18
H.1200 mm.	
Art. 05.230.154	Ø14
Art. 05.230.155	Ø16
Art. 05.230.156	Ø18
H.1500 mm.	
Art. 05.230.157	Ø14
Art. 05.230.158	Ø16
Art. 05.230.159	Ø18

Tondo Lavorato  
Worked Round Bar

H.1000 mm.	
Art. 05.230.160	Ø14
Art. 05.230.161	Ø16
Art. 05.230.162	Ø18
H.1200 mm.	
Art. 05.230.163	Ø14
Art. 05.230.164	Ø16
Art. 05.230.165	Ø18
H.1500 mm.	
Art. 05.230.166	Ø14
Art. 05.230.167	Ø16
Art. 05.230.168	Ø18

Liscio / Smooth  
H.950 x L.120 mm  
Art. 05.230.169 □ 12









<i>Tondo / Round</i>	
H.950 mm.	
Art. 05.231	Ø12
Art. 05.232	Ø14
Art. 05.233	Ø16
Art. 05.234	Ø18
Art. 05.235	Ø20
H.1000 mm.	
Art. 05.236	Ø12
Art. 05.237	Ø14
Art. 05.238	Ø16
Art. 05.239	Ø18
Art. 05.240	Ø20
H.1200 mm.	
Art. 05.241	Ø12
Art. 05.242	Ø14
Art. 05.243	Ø16
Art. 05.244	Ø18
Art. 05.245	Ø20
H.1500 mm.	
Art. 05.246	Ø12
Art. 05.247	Ø14
Art. 05.248	Ø16
Art. 05.249	Ø18
Art. 05.250	Ø20

<i>Tondo / Round</i>	
H.950 mm.	
Art. 05.231.01	Ø12
Art. 05.232.01	Ø14
Art. 05.233.01	Ø16
H.1000 mm.	
Art. 05.236.01	Ø12
Art. 05.237.01	Ø14
Art. 05.238.01	Ø16
H.1200 mm.	
Art. 05.241.01	Ø12
Art. 05.242.01	Ø14
Art. 05.243.01	Ø16
Art. 05.245.01	Ø20
H.1500 mm.	
Art. 05.246.01	Ø12
Art. 05.247.01	Ø14
Art. 05.248.01	Ø16



*Fiamma grande / Big flame*

<i>Tondo / Round</i>	
H.950 mm	
Art. 05.231.02	Ø 12
Art. 05.232.02	Ø 14
Art. 05.233.02	Ø 16
H.1000 mm	
Art. 05.236.02	Ø 12
Art. 05.237.02	Ø 14
Art. 05.238.02	Ø 16
H.1200 mm	
Art. 05.241.02	Ø 12
Art. 05.242.02	Ø 14
Art. 05.243.02	Ø 16
H.1500 mm	
Art. 05.246.02	Ø 12
Art. 05.247.02	Ø 14
Art. 05.248.02	Ø 16



H.950 mm.	
Art. 05.251	□ 12
Art. 05.252	□ 14
Art. 05.253	□ 16
Art. 05.254	□ 18
Art. 05.255	□ 20
H.1000 mm.	
Art. 05.256	□ 12
Art. 05.257	□ 14
Art. 05.258	□ 16
Art. 05.259	□ 18
Art. 05.260	□ 20
H.1200 mm.	
Art. 05.261	□ 12
Art. 05.262	□ 14
Art. 05.263	□ 16
Art. 05.264	□ 18
Art. 05.265	□ 20
H.1500 mm.	
Art. 05.266	□ 12
Art. 05.267	□ 14
Art. 05.268	□ 16
Art. 05.269	□ 18
Art. 05.270	□ 20



*Fiamma grande / Big flame*

<i>Liscio / Smooth</i>	
H.950 mm	
Art. 05.251.02	□ 12
Art. 05.252.02	□ 14
Art. 05.253.02	□ 16
H.1000 mm	
Art. 05.256.02	□ 12
Art. 05.257.02	□ 14
Art. 05.258.02	□ 16
H.1200 mm	
Art. 05.261.02	□ 12
Art. 05.262.02	□ 14
Art. 05.263.02	□ 16
H.1500 mm	
Art. 05.266.02	□ 12
Art. 05.267.02	□ 14
Art. 05.268.02	□ 16



*Fiamma grande / Big flame*

<i>Liscio / Smooth</i>	
H.950 mm	
Art. 05.268.50	□ 12
Art. 05.268.51	□ 14
Art. 05.268.52	□ 16
Art. 05.268.53	Ø 12
Art. 05.268.54	Ø 14
Art. 05.268.55	Ø 16
H.1000 mm	
Art. 05.268.56	□ 12
Art. 05.268.57	□ 14
Art. 05.268.58	□ 16
Art. 05.268.59	Ø 12
Art. 05.268.60	Ø 14
Art. 05.268.61	Ø 16
H.1200 mm	
Art. 05.268.62	□ 12
Art. 05.268.63	□ 14
Art. 05.268.64	□ 16
Art. 05.268.65	Ø 12
Art. 05.268.66	Ø 14
Art. 05.268.67	Ø 16
H.1500 mm	
Art. 05.268.68	□ 12
Art. 05.268.69	□ 14
Art. 05.268.70	□ 16
Art. 05.268.71	Ø 12
Art. 05.268.72	Ø 14
Art. 05.268.73	Ø 16



<i>Martellato / Hammered</i>	
H.950 mm.	
Art. 05.271	□ 12
Art. 05.272	□ 14
Art. 05.273	□ 16
Art. 05.274	□ 18
Art. 05.275	□ 20
H.1000 mm.	
Art. 05.276	□ 12
Art. 05.277	□ 14
Art. 05.278	□ 16
Art. 05.279	□ 18
Art. 05.280	□ 20
H.1200 mm.	
Art. 05.281	□ 12
Art. 05.282	□ 14
Art. 05.283	□ 16
Art. 05.284	□ 18
Art. 05.285	□ 20
H.1500 mm.	
Art. 05.286	□ 12
Art. 05.287	□ 14
Art. 05.288	□ 16
Art. 05.289	□ 18
Art. 05.290	□ 20



*Fiamma grande / Big flame*

<i>Martellato / Hammered</i>	
H.950 mm	
Art. 05.271.02	□ 12
Art. 05.272.02	□ 14
Art. 05.273.02	□ 16
H.1000 mm	
Art. 05.276.02	□ 12
Art. 05.277.02	□ 14
Art. 05.278.02	□ 16
H.1200 mm	
Art. 05.281.02	□ 12
Art. 05.282.02	□ 14
Art. 05.283.02	□ 16
H.1500 mm	
Art. 05.286.02	□ 12
Art. 05.287.02	□ 14
Art. 05.288.02	□ 16



Schiacciata sullo spigolo /  
Ornament on the edge

Liscio / Smooth

H.950 mm

- Art. 05.289.01  12  
Art. 05.289.02  14  
Art. 05.289.03  16

H.1000 mm

- Art. 05.289.04  12  
Art. 05.289.05  14  
Art. 05.289.06  16

H.1200 mm

- Art. 05.289.07  12  
Art. 05.289.08  14  
Art. 05.289.09  16

H.1500 mm

- Art. 05.289.10  12  
Art. 05.289.11  14  
Art. 05.289.12  16



Martellato / Hammered

H.950 mm

- Art. 05.290.01  12  
Art. 05.290.02  14  
Art. 05.290.03  16

H.1000 mm

- Art. 05.290.04  12  
Art. 05.290.05  14  
Art. 05.290.06  16

H.1200 mm

- Art. 05.290.07  12  
Art. 05.290.08  14  
Art. 05.290.09  16

H.1500 mm

- Art. 05.290.10  12  
Art. 05.290.11  14  
Art. 05.290.12  16



Liscio / Smooth

H.950 mm

- Art. 05.290.13  12  
Art. 05.290.14  14  
Art. 05.290.15  16

H.1000 mm

- Art. 05.290.16  12  
Art. 05.290.17  14  
Art. 05.290.18  16

H.1200 mm

- Art. 05.290.19  12  
Art. 05.290.20  14  
Art. 05.290.21  16

H.1500 mm

- Art. 05.290.22  12  
Art. 05.290.23  14  
Art. 05.290.24  16



H.950 mm.

- Art. 05.291  12  
Art. 05.292  14  
Art. 05.293  16

H.1000 mm.

- Art. 05.294  12  
Art. 05.295  14  
Art. 05.296  16

H.1200 mm.

- Art. 05.297  12  
Art. 05.298  14  
Art. 05.299  16

H.1500 mm.

- Art. 05.300  12  
Art. 05.301  14  
Art. 05.302  16



H.950 mm.

- Art. 05.303  12  
Art. 05.304  14  
Art. 05.305  16  
Art. 05.306  18  
Art. 05.307  20

H.1000 mm.

- Art. 05.308  12  
Art. 05.309  14  
Art. 05.310  16  
Art. 05.311  18  
Art. 05.312  20

H.1200 mm.

- Art. 05.313  12  
Art. 05.314  14  
Art. 05.315  16  
Art. 05.316  18  
Art. 05.317  20

H.1500 mm.

- Art. 05.318  12  
Art. 05.319  14  
Art. 05.320  16  
Art. 05.321  18  
Art. 05.322  20



H.950 mm.

- Art. 05.323  12  
Art. 05.324  14  
Art. 05.325  16  
Art. 05.326  18  
Art. 05.327  20

H.1000 mm.

- Art. 05.328  12  
Art. 05.329  14  
Art. 05.330  16  
Art. 05.331  18  
Art. 05.332  20

H.1200 mm.

- Art. 05.333  12  
Art. 05.334  14  
Art. 05.335  16  
Art. 05.336  18  
Art. 05.337  20

H.1500 mm.

- Art. 05.338  12  
Art. 05.339  14  
Art. 05.340  16  
Art. 05.341  18  
Art. 05.342  20



Liscio / Smooth

H.950 mm

- Art. 05.342.20  12  
Art. 05.342.21  14

H.1000 mm

- Art. 05.342.22  12  
Art. 05.342.23  14

H.1200 mm

- Art. 05.342.24  12  
Art. 05.342.25  14

H.1500 mm

- Art. 05.342.26  12  
Art. 05.342.27  14



Liscio

≠ 25 x 8 mm

- Art. 05.342.100 H.950  
Art. 05.342.101 H.1000  
Art. 05.342.102 H.1200  
Art. 05.342.103 H.1500

Liscio

≠ 30 x 8 mm

- Art. 05.342.104 H.950  
Art. 05.342.105 H.1000  
Art. 05.342.106 H.1200  
Art. 05.342.107 H.1500



Martellato / Hammered

H.950 mm.

- Art. 05.343  12  
Art. 05.344  14

H.1000 mm.

- Art. 05.345  12  
Art. 05.346  14

H.1200 mm.

- Art. 05.347  12  
Art. 05.348  14

H.1500 mm.

- Art. 05.349  12  
Art. 05.350  14



Liscio / Smooth  
H 950 mm

- Art. 05.350.100 Ø12  
Art. 05.350.101 Ø14

H 1000 mm

- Art. 05.350.103 Ø12  
Art. 05.350.104 Ø14



Liscio / Smooth

H 950 mm

- Art. 05.350.125  12  
Art. 05.350.126  14  
Art. 05.350.127  16

H 1000 mm

- Art. 05.350.130  12  
Art. 05.350.131  14  
Art. 05.350.132  16



PALLINE PICCOLE /  
SMALL BALLS



PALLINE GRANDI /  
LARGE BALLS

PALLINE GRANDI / LARGE BALLS



- |             |      |
|-------------|------|
| H.950 mm.   |      |
| Art. 05.351 | □ 12 |
| Art. 05.352 | □ 14 |
| Art. 05.353 | □ 16 |
| Art. 05.354 | □ 18 |
| Art. 05.355 | □ 20 |
| H.1000 mm.  |      |
| Art. 05.356 | □ 12 |
| Art. 05.357 | □ 14 |
| Art. 05.358 | □ 16 |
| Art. 05.359 | □ 18 |
| Art. 05.360 | □ 20 |
| H.1200 mm.  |      |
| Art. 05.361 | □ 12 |
| Art. 05.362 | □ 14 |
| Art. 05.363 | □ 16 |
| Art. 05.364 | □ 18 |
| Art. 05.365 | □ 20 |
| H.1500 mm.  |      |
| Art. 05.366 | □ 12 |
| Art. 05.367 | □ 14 |
| Art. 05.368 | □ 16 |
| Art. 05.369 | □ 18 |
| Art. 05.370 | □ 20 |

- |             |      |
|-------------|------|
| H.950 mm.   |      |
| Art. 05.371 | □ 12 |
| Art. 05.372 | □ 14 |
| Art. 05.373 | □ 16 |
| Art. 05.374 | □ 18 |
| Art. 05.375 | □ 20 |
| H.1000 mm.  |      |
| Art. 05.376 | □ 12 |
| Art. 05.377 | □ 14 |
| Art. 05.378 | □ 16 |
| Art. 05.379 | □ 18 |
| Art. 05.380 | □ 20 |
| H.1200 mm.  |      |
| Art. 05.381 | □ 12 |
| Art. 05.382 | □ 14 |
| Art. 05.383 | □ 16 |
| Art. 05.384 | □ 18 |
| Art. 05.385 | □ 20 |
| H.1500 mm.  |      |
| Art. 05.386 | □ 12 |
| Art. 05.387 | □ 14 |
| Art. 05.388 | □ 16 |
| Art. 05.389 | □ 18 |
| Art. 05.390 | □ 20 |

Martellato / Hammered

Martellato / Hammered

- |                |      |
|----------------|------|
| H.950 mm.      |      |
| Art. 05.390.01 | □ 12 |
| Art. 05.390.02 | □ 14 |
| H.1000 mm.     |      |
| Art. 05.390.03 | □ 12 |
| Art. 05.390.04 | □ 14 |
| H.1200 mm.     |      |
| Art. 05.390.05 | □ 12 |
| Art. 05.390.06 | □ 14 |
| H.1500 mm.     |      |
| Art. 05.390.07 | □ 12 |
| Art. 05.390.08 | □ 14 |

- |                |      |
|----------------|------|
| H.950 mm.      |      |
| Art. 05.390.09 | □ 12 |
| Art. 05.390.10 | □ 14 |
| H.1000 mm.     |      |
| Art. 05.390.11 | □ 12 |
| Art. 05.390.12 | □ 14 |
| H.1200 mm.     |      |
| Art. 05.390.13 | □ 12 |
| Art. 05.390.14 | □ 14 |
| H.1500 mm.     |      |
| Art. 05.390.15 | □ 12 |
| Art. 05.390.16 | □ 14 |

- |             |      |
|-------------|------|
| H.950 mm.   |      |
| Art. 05.399 | □ 12 |
| Art. 05.400 | □ 14 |
| H.1000 mm.  |      |
| Art. 05.401 | □ 12 |
| Art. 05.402 | □ 14 |
| H.1200 mm.  |      |
| Art. 05.403 | □ 12 |
| Art. 05.404 | □ 14 |
| H.1500 mm.  |      |
| Art. 05.405 | □ 12 |
| Art. 05.406 | □ 14 |

- |             |      |
|-------------|------|
| H.950 mm.   |      |
| Art. 05.407 | □ 12 |
| Art. 05.408 | □ 14 |
| H.1000 mm.  |      |
| Art. 05.409 | □ 12 |
| Art. 05.410 | □ 14 |
| H.1200 mm.  |      |
| Art. 05.411 | □ 12 |
| Art. 05.412 | □ 14 |
| H.1500 mm.  |      |
| Art. 05.413 | □ 12 |
| Art. 05.414 | □ 14 |

Tondo / Round

- |                |     |
|----------------|-----|
| H.950 mm.      |     |
| Art. 05.414.01 | Ø12 |
| Art. 05.414.02 | Ø14 |
| Art. 05.414.03 | Ø16 |
| H.1000 mm.     |     |
| Art. 05.414.04 | Ø12 |
| Art. 05.414.05 | Ø14 |
| Art. 05.414.06 | Ø16 |
| H.1200 mm.     |     |
| Art. 05.414.07 | Ø12 |
| Art. 05.414.08 | Ø14 |
| Art. 05.414.09 | Ø16 |
| H.1500 mm.     |     |
| Art. 05.414.10 | Ø12 |
| Art. 05.414.11 | Ø14 |
| Art. 05.414.12 | Ø16 |

PALLINE GRANDI / LARGE BALLS

PALLINE PICCOLE / SMALL BALLS



- |                |     |
|----------------|-----|
| Tondo / Round  |     |
| H.950 mm.      |     |
| Art. 05.414.13 | Ø12 |
| Art. 05.414.14 | Ø14 |
| Art. 05.414.15 | Ø16 |
| H.1000 mm.     |     |
| Art. 05.414.16 | Ø12 |
| Art. 05.414.17 | Ø14 |
| Art. 05.414.18 | Ø16 |
| H.1200 mm.     |     |
| Art. 05.414.19 | Ø12 |
| Art. 05.414.20 | Ø14 |
| Art. 05.414.21 | Ø16 |
| H.1500 mm.     |     |
| Art. 05.414.22 | Ø12 |
| Art. 05.414.23 | Ø14 |
| Art. 05.414.24 | Ø16 |

- |             |      |
|-------------|------|
| H.950 mm.   |      |
| Art. 05.415 | □ 12 |
| Art. 05.416 | □ 14 |
| H.1000 mm.  |      |
| Art. 05.417 | □ 12 |
| Art. 05.418 | □ 14 |
| H.1200 mm.  |      |
| Art. 05.419 | □ 12 |
| Art. 05.420 | □ 14 |
| H.1500 mm.  |      |
| Art. 05.421 | □ 12 |
| Art. 05.422 | □ 14 |

- |                     |      |
|---------------------|------|
| H.950 mm.           |      |
| Art. 05.422.01      | □ 12 |
| Art. 05.422.02      | □ 14 |
| Art. 05.422.03      | □ 16 |
| Art. 05.422.04      | □ 18 |
| Art. 05.422.05      | □ 20 |
| H.1000 mm.          |      |
| Art. 05.422.06      | □ 12 |
| Art. 05.422.07      | □ 14 |
| Art. 05.422.08      | □ 16 |
| Art. 05.422.09      | □ 18 |
| Art. 05.422.10      | □ 20 |
| H.1200 mm.          |      |
| Art. 05.422.11      | □ 12 |
| Art. 05.422.12      | □ 14 |
| Art. 05.422.13      | □ 16 |
| Art. 05.422.14      | □ 18 |
| Art. 05.422.15      | □ 20 |
| H.1500 mm.          |      |
| Art. 05.422.16      | □ 12 |
| Art. 05.422.17      | □ 14 |
| Art. 05.422.18      | □ 16 |
| Art. 05.422.19      | □ 18 |
| Art. 05.422.20      | □ 20 |
| H.2000 mm. NEW      |      |
| Art. 05.422.02.2000 | □ 14 |

- |                       |      |
|-----------------------|------|
| Martellato / Hammered |      |
| H.950 mm.             |      |
| Art. 05.422.21        | □ 12 |
| Art. 05.422.22        | □ 14 |
| Art. 05.422.23        | □ 16 |
| Art. 05.422.24        | □ 18 |
| Art. 05.422.25        | □ 20 |
| H.1000 mm.            |      |
| Art. 05.422.26        | □ 12 |
| Art. 05.422.27        | □ 14 |
| Art. 05.422.28        | □ 16 |
| Art. 05.422.29        | □ 18 |
| Art. 05.422.30        | □ 20 |
| H.1200 mm.            |      |
| Art. 05.422.31        | □ 12 |
| Art. 05.422.32        | □ 14 |
| Art. 05.422.33        | □ 16 |
| Art. 05.422.34        | □ 18 |
| Art. 05.422.35        | □ 20 |
| H.1500 mm.            |      |
| Art. 05.422.36        | □ 12 |
| Art. 05.422.37        | □ 14 |
| Art. 05.422.38        | □ 16 |
| Art. 05.422.39        | □ 18 |
| Art. 05.422.40        | □ 20 |

- |                     |     |
|---------------------|-----|
| Tondo / Round       |     |
| H.950 mm.           |     |
| Art. 05.422.41      | Ø12 |
| Art. 05.422.42      | Ø14 |
| Art. 05.422.43      | Ø16 |
| Art. 05.422.44      | Ø18 |
| H.1000 mm.          |     |
| Art. 05.422.45      | Ø12 |
| Art. 05.422.46      | Ø14 |
| Art. 05.422.47      | Ø16 |
| Art. 05.422.48      | Ø18 |
| H.1200 mm.          |     |
| Art. 05.422.49      | Ø12 |
| Art. 05.422.50      | Ø14 |
| Art. 05.422.51      | Ø16 |
| Art. 05.422.52      | Ø18 |
| H.1500 mm.          |     |
| Art. 05.422.53      | Ø12 |
| Art. 05.422.54      | Ø14 |
| Art. 05.422.55      | Ø16 |
| Art. 05.422.56      | Ø18 |
| H.2000 mm. NEW      |     |
| Art. 05.422.42.2000 | Ø14 |

- |                |      |
|----------------|------|
| H.950 mm.      |      |
| Art. 05.422.57 | □ 12 |
| Art. 05.422.58 | □ 14 |
| Art. 05.422.59 | □ 16 |
| Art. 05.422.60 | □ 18 |
| Art. 05.422.61 | □ 20 |
| H.1000 mm.     |      |
| Art. 05.422.62 | □ 12 |
| Art. 05.422.63 | □ 14 |
| Art. 05.422.64 | □ 16 |
| Art. 05.422.65 | □ 18 |
| Art. 05.422.66 | □ 20 |
| H.1200 mm.     |      |
| Art. 05.422.67 | □ 12 |
| Art. 05.422.68 | □ 14 |
| Art. 05.422.69 | □ 16 |
| Art. 05.422.70 | □ 18 |
| Art. 05.422.71 | □ 20 |
| H.1500 mm.     |      |
| Art. 05.422.72 | □ 12 |
| Art. 05.422.73 | □ 14 |
| Art. 05.422.74 | □ 16 |
| Art. 05.422.75 | □ 18 |
| Art. 05.422.76 | □ 20 |

PALLINE PICCOLE / SMALL BALLS



H.950 mm.  
Art. 05.422.77  12  
Art. 05.422.78  14  
Art. 05.422.79  16

Martellato / *Hammered*  
H.950 mm.  
Art. 05.422.80  12  
Art. 05.422.81  14  
Art. 05.422.82  16

Tondo / *Round*  
H.950 mm.  
Art. 05.422.83 Ø14  
Art. 05.422.84 Ø16

H.950 mm.  
Art. 05.422.85  12  
Art. 05.422.86  14  
Art. 05.422.87  16

Martellato / *Hammered*  
H.950 mm.  
Art. 05.422.88  12  
Art. 05.422.89  14  
Art. 05.422.90  16

Tondo / *Round*  
H.950 mm.  
Art. 05.422.91 Ø14  
Art. 05.422.92 Ø16

H.950 mm.  
Art. 05.422.93  12  
Art. 05.422.94  14  
Art. 05.422.95  16

PALLINE PICCOLE / SMALL BALLS

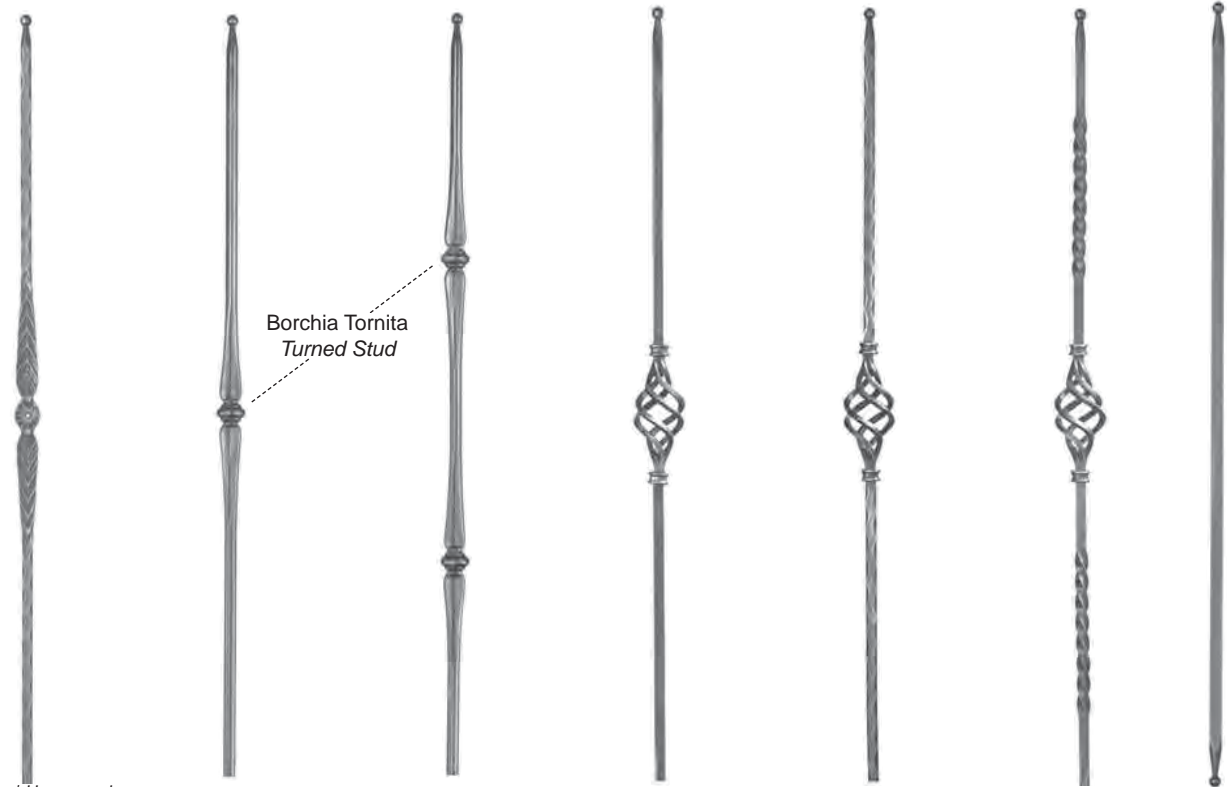

Martellato / *Hammered*  
H.950 mm.  
Art. 05.422.96  12  
Art. 05.422.97  14  
Art. 05.422.98  16

Tondo / *Round*  
H.950 mm.  
Art. 05.422.99 Ø12  
Art. 05.422.100 Ø14

Borchia Tornita  
*Turned Stud*

Tondo / *Round*  
H.950 mm.  
Art. 05.422.101 Ø12  
Art. 05.422.102 Ø14

H.950 mm.  
Art. 05.422.103  12  
Art. 05.422.104  14

Martellato / *Hammered*  
H.950 mm.  
Art. 05.422.105  12  
Art. 05.422.106  14

H.950 mm.  
Art. 05.422.107  12  
Art. 05.422.108  14

H.950 mm.  
Art. 05.422.109  12  
Art. 05.422.110  14  
Art. 05.422.111  16  
Art. 05.422.112  18  
Art. 05.422.113  20







H.1000 mm.  
Art. 05.422.114  12  
Art. 05.422.115  14  
Art. 05.422.116  16  
Art. 05.422.117  18  
Art. 05.422.118  20

H.1200 mm.  
Art. 05.422.119  12  
Art. 05.422.120  14  
Art. 05.422.121  16  
Art. 05.422.122  18  
Art. 05.422.123  20







H.1500 mm.  
Art. 05.422.124  12  
Art. 05.422.125  14  
Art. 05.422.126  16  
Art. 05.422.127  18  
Art. 05.422.128  20

Tutte le parti di questo catalogo - foto comprese - sono di proprietà Euro-Fer. La riproduzione, anche parziale, è vietata in ogni forma e con ogni mezzo. / Every part of this catalogue - photos included - is Euro-Fer's property. All forms of copying are strictly prohibited.

PALLINE PICCOLE / SMALL BALLS

 <p>Martellato / <i>Hammered</i></p> <p>H.950 mm.</p> <p>Art. 05.422.129 <input type="checkbox"/> 12 Art. 05.422.130 <input type="checkbox"/> 14 Art. 05.422.131 <input type="checkbox"/> 16 Art. 05.422.132 <input type="checkbox"/> 18 Art. 05.422.133 <input type="checkbox"/> 20</p> <p>H.1000 mm.</p> <p>Art. 05.422.134 <input type="checkbox"/> 12 Art. 05.422.135 <input type="checkbox"/> 14 Art. 05.422.136 <input type="checkbox"/> 16 Art. 05.422.137 <input type="checkbox"/> 18 Art. 05.422.138 <input type="checkbox"/> 20</p> <p>H.1200 mm.</p> <p>Art. 05.422.139 <input type="checkbox"/> 12 Art. 05.422.140 <input type="checkbox"/> 14 Art. 05.422.141 <input type="checkbox"/> 16 Art. 05.422.142 <input type="checkbox"/> 18 Art. 05.422.143 <input type="checkbox"/> 20</p> <p>H.1500 mm.</p> <p>Art. 05.422.144 <input type="checkbox"/> 12 Art. 05.422.145 <input type="checkbox"/> 14 Art. 05.422.146 <input type="checkbox"/> 16 Art. 05.422.147 <input type="checkbox"/> 18 Art. 05.422.148 <input type="checkbox"/> 20</p>	 <p>Tondo / <i>Round</i></p> <p>H.950 mm.</p> <p>Art. 05.422.149 <input type="checkbox"/> Ø12 Art. 05.422.150 <input type="checkbox"/> Ø14 Art. 05.422.151 <input type="checkbox"/> Ø16 Art. 05.422.152 <input type="checkbox"/> Ø18</p> <p>H.1000 mm.</p> <p>Art. 05.422.153 <input type="checkbox"/> Ø12 Art. 05.422.154 <input type="checkbox"/> Ø14 Art. 05.422.155 <input type="checkbox"/> Ø16 Art. 05.422.156 <input type="checkbox"/> Ø18</p> <p>H.1200 mm.</p> <p>Art. 05.422.157 <input type="checkbox"/> Ø12 Art. 05.422.158 <input type="checkbox"/> Ø14 Art. 05.422.159 <input type="checkbox"/> Ø16 Art. 05.422.160 <input type="checkbox"/> Ø18</p> <p>H.1500 mm.</p> <p>Art. 05.422.161 <input type="checkbox"/> Ø12 Art. 05.422.162 <input type="checkbox"/> Ø14 Art. 05.422.163 <input type="checkbox"/> Ø16 Art. 05.422.164 <input type="checkbox"/> Ø18</p>	 <p>H.950 mm.</p> <p>Art. 05.422.165 <input type="checkbox"/> 12 Art. 05.422.166 <input type="checkbox"/> 14 Art. 05.422.167 <input type="checkbox"/> 16 Art. 05.422.168 <input type="checkbox"/> 18 Art. 05.422.169 <input type="checkbox"/> 20</p> <p>H.1000 mm.</p> <p>Art. 05.422.170 <input type="checkbox"/> 12 Art. 05.422.171 <input type="checkbox"/> 14 Art. 05.422.172 <input type="checkbox"/> 16 Art. 05.422.173 <input type="checkbox"/> 18 Art. 05.422.174 <input type="checkbox"/> 20</p> <p>H.1200 mm.</p> <p>Art. 05.422.175 <input type="checkbox"/> 12 Art. 05.422.176 <input type="checkbox"/> 14 Art. 05.422.177 <input type="checkbox"/> 16 Art. 05.422.178 <input type="checkbox"/> 18 Art. 05.422.179 <input type="checkbox"/> 20</p> <p>H.1500 mm.</p> <p>Art. 05.422.180 <input type="checkbox"/> 12 Art. 05.422.181 <input type="checkbox"/> 14 Art. 05.422.182 <input type="checkbox"/> 16 Art. 05.422.183 <input type="checkbox"/> 18 Art. 05.422.184 <input type="checkbox"/> 20</p>	 <p>H.950 mm.</p> <p>Art. 05.422.185 <input type="checkbox"/> 12 Art. 05.422.186 <input type="checkbox"/> 14 Art. 05.422.187 <input type="checkbox"/> 16</p>	 <p>Martellato / <i>Hammered</i></p> <p>H.950 mm.</p> <p>Art. 05.422.188 <input type="checkbox"/> 12 Art. 05.422.189 <input type="checkbox"/> 14 Art. 05.422.190 <input type="checkbox"/> 16</p>	 <p>Tondo / <i>Round</i></p> <p>H.950 mm.</p> <p>Art. 05.422.191 <input type="checkbox"/> Ø14 Art. 05.422.192 <input type="checkbox"/> Ø16</p>
---	---	---	---	--	--

PALLINE PICCOLE / SMALL BALLS

 <p>H.950 mm.</p> <p>Art. 05.422.193 <input type="checkbox"/> 12 Art. 05.422.194 <input type="checkbox"/> 14 Art. 05.422.195 <input type="checkbox"/> 16</p>	 <p>Martellato / <i>Hammered</i></p> <p>H.950 mm.</p> <p>Art. 05.422.196 <input type="checkbox"/> 12 Art. 05.422.197 <input type="checkbox"/> 14 Art. 05.422.198 <input type="checkbox"/> 16</p>	 <p>Tondo / <i>Round</i></p> <p>H.950 mm.</p> <p>Art. 05.422.199 <input type="checkbox"/> Ø14 Art. 05.422.200 <input type="checkbox"/> Ø16</p>	 <p>H.950 mm.</p> <p>Art. 05.422.201 <input type="checkbox"/> 12 Art. 05.422.202 <input type="checkbox"/> 14 Art. 05.422.203 <input type="checkbox"/> 16</p>	 <p>Martellato / <i>Hammered</i></p> <p>H.950 mm.</p> <p>Art. 05.422.204 <input type="checkbox"/> 12 Art. 05.422.205 <input type="checkbox"/> 14 Art. 05.422.206 <input type="checkbox"/> 16</p>	 <p>Tondo / <i>Round</i></p> <p>H.950 mm.</p> <p>Art. 05.422.207 <input type="checkbox"/> Ø12 Art. 05.422.208 <input type="checkbox"/> Ø14</p>	 <p>Tondo / <i>Round</i></p> <p>H.950 mm.</p> <p>Art. 05.422.209 <input type="checkbox"/> Ø12 Art. 05.422.210 <input type="checkbox"/> Ø14</p>
---	---	---	---	---	---	---

Borchia Tornita  
*Turned Stud*

Tutte le parti di questo catalogo - foto comprese - sono di proprietà Euro-Fer. La riproduzione, anche parziale, è vietata in ogni forma e con ogni mezzo. / Every part of this catalogue - photos included - is Euro-Fer's property. All forms of copying are strictly prohibited.



PALLINE PICCOLE / SMALL BALLS



H.950 mm.  
Art. 05.422.211  12  
Art. 05.422.212  14



Martellato / Hammered  
H.950 mm.  
Art. 05.422.213  12  
Art. 05.422.214  14



H.950 mm.  
Art. 05.422.215  12  
Art. 05.422.216  14



Pallina piccola / Small ball  
Liscio / Smooth

H.950 mm  
Art. 05.422.250  12 mm  
Art. 05.422.251  14 mm  
Art. 05.422.252  16 mm

H.1000 mm  
Art. 05.422.253  12 mm  
Art. 05.422.254  14 mm  
Art. 05.422.255  16 mm

H.1200 mm  
Art. 05.422.256  12 mm  
Art. 05.422.257  14 mm  
Art. 05.422.258  16 mm

H.1500 mm  
Art. 05.422.259  12 mm  
Art. 05.422.260  14 mm  
Art. 05.422.261  16 mm



Pallina piccola / Small ball  
Martellato / Hammered

H.950 mm  
Art. 05.422.300  12 mm  
Art. 05.422.301  14 mm  
Art. 05.422.302  16 mm

H.1000 mm  
Art. 05.422.303  12 mm  
Art. 05.422.304  14 mm  
Art. 05.422.305  16 mm

H.1200 mm  
Art. 05.422.306  12 mm  
Art. 05.422.307  14 mm  
Art. 05.422.308  16 mm

H.1500 mm  
Art. 05.422.309  12 mm  
Art. 05.422.310  14 mm  
Art. 05.422.311  16 mm



Liscio / Smooth  
H.1000 mm  
Art. 05.427.01  12 mm  
Art. 05.427.02  14 mm



Liscio / Smooth  
H.1000 mm  
Art. 05.427.04  12 mm  
Art. 05.427.05  14 mm



Liscio / Smooth  
H.1000 mm  
Art. 05.427.07  12 mm  
Art. 05.427.08  14 mm



Liscio / Smooth  
H.1000 mm  
Art. 05.427.10  12 mm  
Art. 05.427.11  14 mm

NEW



Liscio / Smooth  
H.1000 mm  
Art. 05.427.20  12

NEW



Liscio / Smooth  
H.1000 mm  
Art. 05.427.21  12



Liscio / Smooth  
H.950 mm  
Art. 05.427.50  12  
Art. 05.427.51  14  
H.1000 mm  
Art. 05.427.52  12  
Art. 05.427.53  14  
H.1200 mm  
Art. 05.427.54  12  
Art. 05.427.55  14  
H.1500 mm  
Art. 05.427.56  12  
Art. 05.427.57  14

Modello Catania / Catania model

**PALLINE SU BARRE / BALLS ON BARS**

SU RICHIESTA SIAMO IN GRADO DI PRODURRE I SEGUENTI PALETTI CON PALLINA ANCHE SU MISURA.  
 ON REQUEST WE ARE ABLE TO MANUFACTURE THE FOLLOWING BALL ON BAR INFILLS, CUSTOMIZED ALSO AVAILABLE.

Pallina / Ball Ø 16 mm - H. 1000

Art. 05.427.100 tondo liscio Ø 12 mm con pallina Ø 16 mm / round plain 12 mm solid bar with 16 mm ball

Pallina / Ball Ø 18 mm - H. 1000

Art. 05.427.110 tondo liscio Ø 12 mm con pallina Ø 18 mm / round plain 12 mm solid bar with 18 mm ball

Art. 05.427.112 tondo liscio Ø 14 mm con pallina Ø 18 mm / round plain 14 mm solid bar with 18 mm ball

Art. 05.427.115 quadro liscio □ 12x12 mm con pallina Ø 18 mm / square plain □ 12x12 mm solid bar with 18 mm ball

Pallina / Ball Ø 20 mm - H. 1000

Art. 05.427.130 tondo liscio Ø 12 mm con pallina Ø 20 mm / round plain 12 mm solid bar with 20 mm ball

Art. 05.427.132 tondo liscio Ø 14 mm con pallina Ø 20 mm / round plain 12 mm solid bar with 20 mm ball

Art. 05.427.134 tondo liscio Ø 16 mm con pallina Ø 20 mm / round plain 14 mm solid bar with 20 mm ball

Art. 05.427.140 quadro liscio □ 12x12 mm con pallina Ø 20 mm / square plain □ 12x12 mm solid bar with 20 mm ball

Art. 05.427.142 quadro liscio □ 14x14 mm con pallina Ø 20 mm / square plain □ 14x14 mm solid bar with 20 mm ball

Pallina / Ball Ø 24 mm - H. 1000

Art. 05.427.160 tondo liscio Ø 12 mm con pallina Ø 24 mm / round plain 12 mm solid bar with 24 mm ball

Art. 05.427.162 tondo liscio Ø 14 mm con pallina Ø 24 mm / round plain 12 mm solid bar with 24 mm ball

Art. 05.427.164 tondo liscio Ø 16 mm con pallina Ø 24 mm / round plain 14 mm solid bar with 24 mm ball

Art. 05.427.170 quadro liscio □ 12x12 mm con pallina Ø 24 mm / square plain □ 12x12 mm solid bar with 24 mm ball

Art. 05.427.172 quadro liscio □ 14x14 mm con pallina Ø 24 mm / square plain □ 14x14 mm solid bar with 24 mm ball

Art. 05.427.174 quadro liscio □ 16x16 mm con pallina Ø 24 mm / square plain □ 16x16 mm solid bar with 24 mm ball



Paletti / Bars H. 1000

**Pigne a 9 Trafilati / 9 - Element Basket**

Tubi ferro conformati / Cone - shaped iron tubes

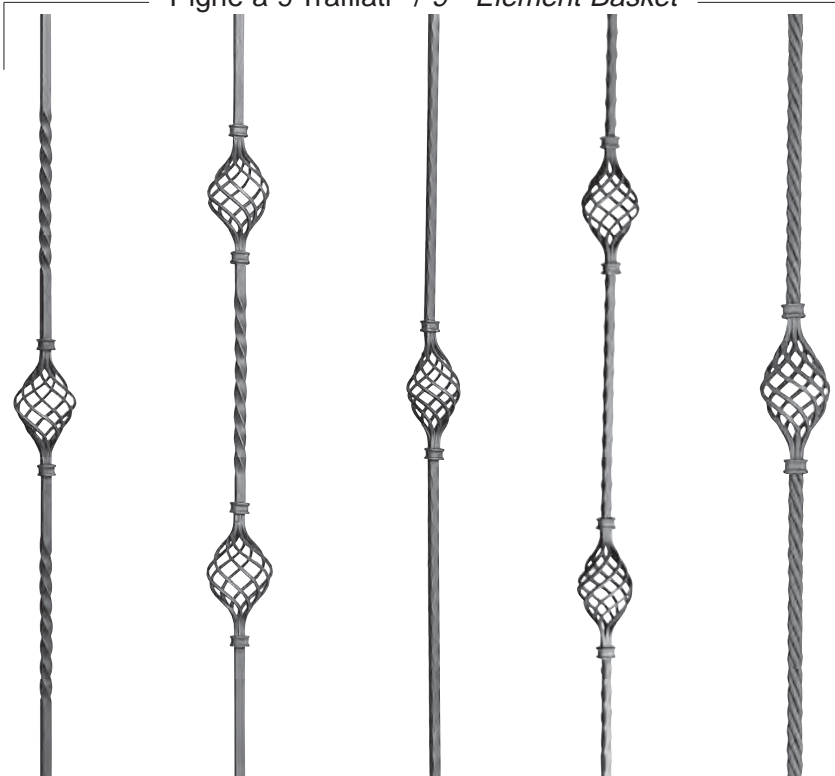

H.730 mm.  
 Art. 05.428 Ø 22  
 Art. 05.429 Ø 30  
 H.830 mm.  
 Art. 05.430 Ø 22  
 Art. 05.431 Ø 30

H.950 mm.  
 Art. 05.432 □ 12

H.950 mm.  
 Art. 05.433 □ 12

Martell. / Hammered  
 H.950 mm.  
 Art. 05.434 □ 12

Martell. / Hammered  
 H.950 mm.  
 Art. 05.435 □ 12

H.950 mm.  
 Art. 05.436 Ø 15

NEW

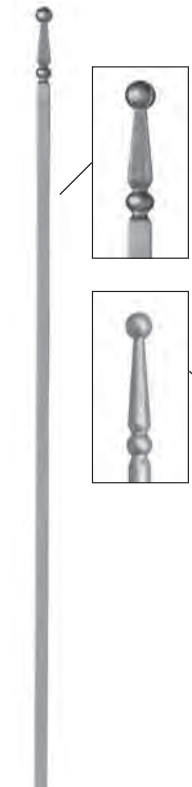

Liscio / Smooth  
 H.1000 mm  
 Art. 05.436.10 □ 14  
 Art. 05.436.15 □ 12

NEW



Liscio / Smooth  
 H.1000 mm  
 Art. 05.436.20 Ø 12

**PANNELLI LISCI E PALETTI PER RECINZIONI**  
**PLAIN PANEL UNITS AND STAKES FOR FENCES**



H.900 X L.330 mm.  
**Art. 05.437** Ø 14



H.900 X L.350 mm.  
**Art. 05.437.01** ≙ 12 X 6 mm.  
**Art. 05.437.02** ≙ 14 X 6 mm.



Martellato / *Hammered*  
H.860 X L.350 mm.  
**Art. 05.438** ≙ 12 X 6 mm.  
**Art. 05.438.01** ≙ 16 X 5 mm.



Martellato / *Hammered*  
H.860 X L.350 mm.  
**Art. 05.438.02** ≙ 12 X 6 mm.  
**Art. 05.438.03** ≙ 16 X 5 mm.



Liscio / *Smooth*  
H.900 X L.330 mm.  
**Art. 05.439** □ 14  
Martellato / *Hammered*  
H.900 X L.330 mm.  
**Art. 05.440** □ 14



Con fiori su ambo i lati  
*Flowers on both sides*  
H.900 X L.350 mm.  
**Art. 05.440.01** □ 12



H.900 X L.350 mm.  
**Art. 05.440.02** Ø 10



Modello Scala / *Scala Model*  
H.860 x L.350 mm  
**Art. 05.440.03** ≙ 14 x 6 mm



Liscio / *Smooth*  
H.900 x L.370 mm  
**Art. 05.440.05** ≙ 12 x 6 mm



H.1100 mm.  
**Art. 05.441** □ 25  
**Art. 05.442** □ 30



Liscio / *Smooth*  
H.950 mm.  
**Art. 05.443** Ø 12



Liscio / *Smooth*  
H.950 mm.  
**Art. 05.444** Ø 12



Liscio / *Smooth*  
H.950 mm.  
**Art. 05.445** Ø 12

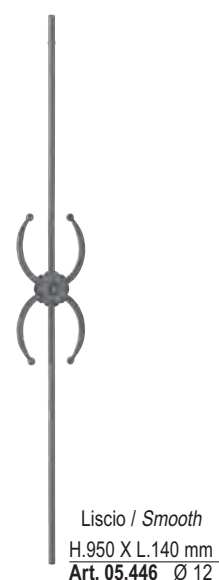

Liscio / *Smooth*  
H.950 X L.140 mm  
**Art. 05.446** Ø 12



Liscio / *Smooth*  
H.950 X L.100 mm.  
**Art. 05.447** Ø 12



Liscio / *Smooth*  
H.950 X L.100 mm.  
**Art. 05.448** Ø 12



Liscio / *Smooth*  
H.950 x L.180 mm  
**Art. 05.448.01** Ø 12 mm  
Con fiori su ambo i lati /  
*Flowers on both sides*



Fiore in ottone / *Brass flower*



Liscio / *Smooth*  
H.950 x mm  
**Art. 05.448.02**  
Ø 12 mm  
**Art. 05.448.03**  
Ø 14 mm

Con fiori su ambo  
i lati / *Flowers  
on both sides*



Liscio / *Smooth*  
H.950 X L.120 mm.  
**Art. 05.449** Ø 12



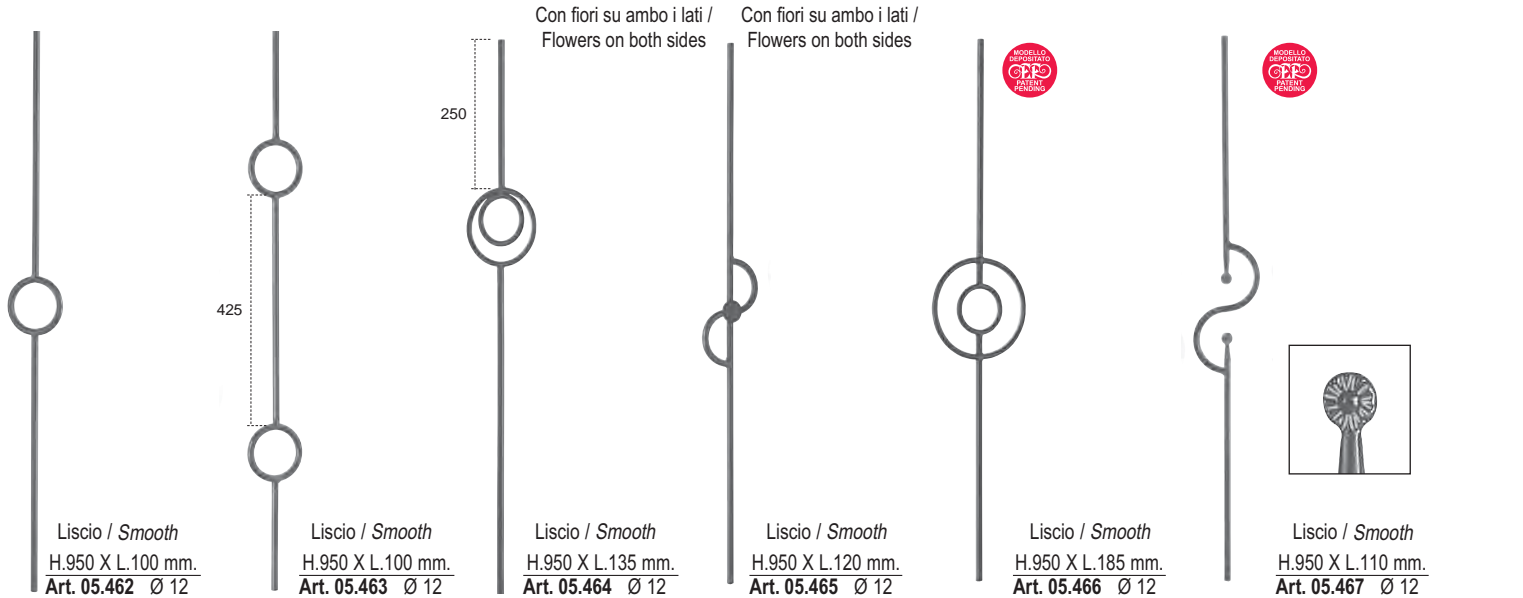
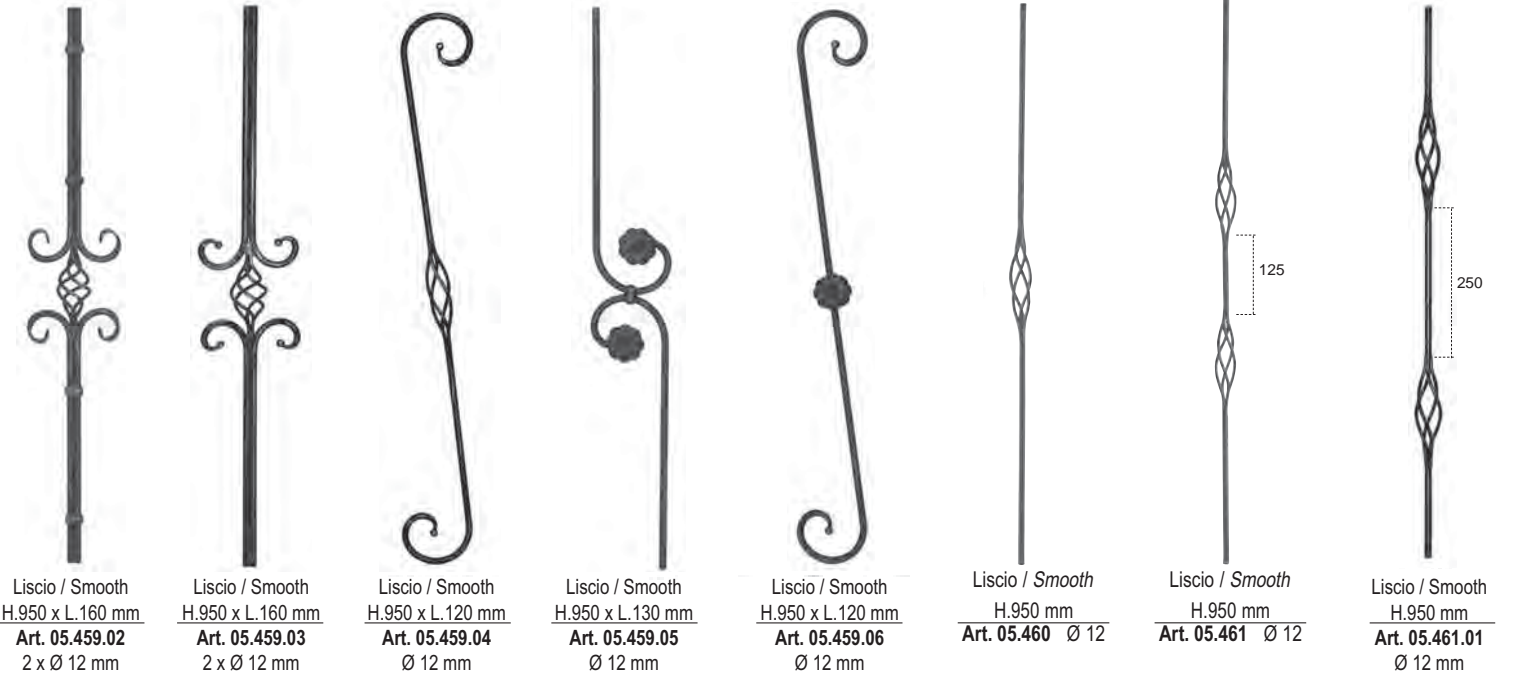
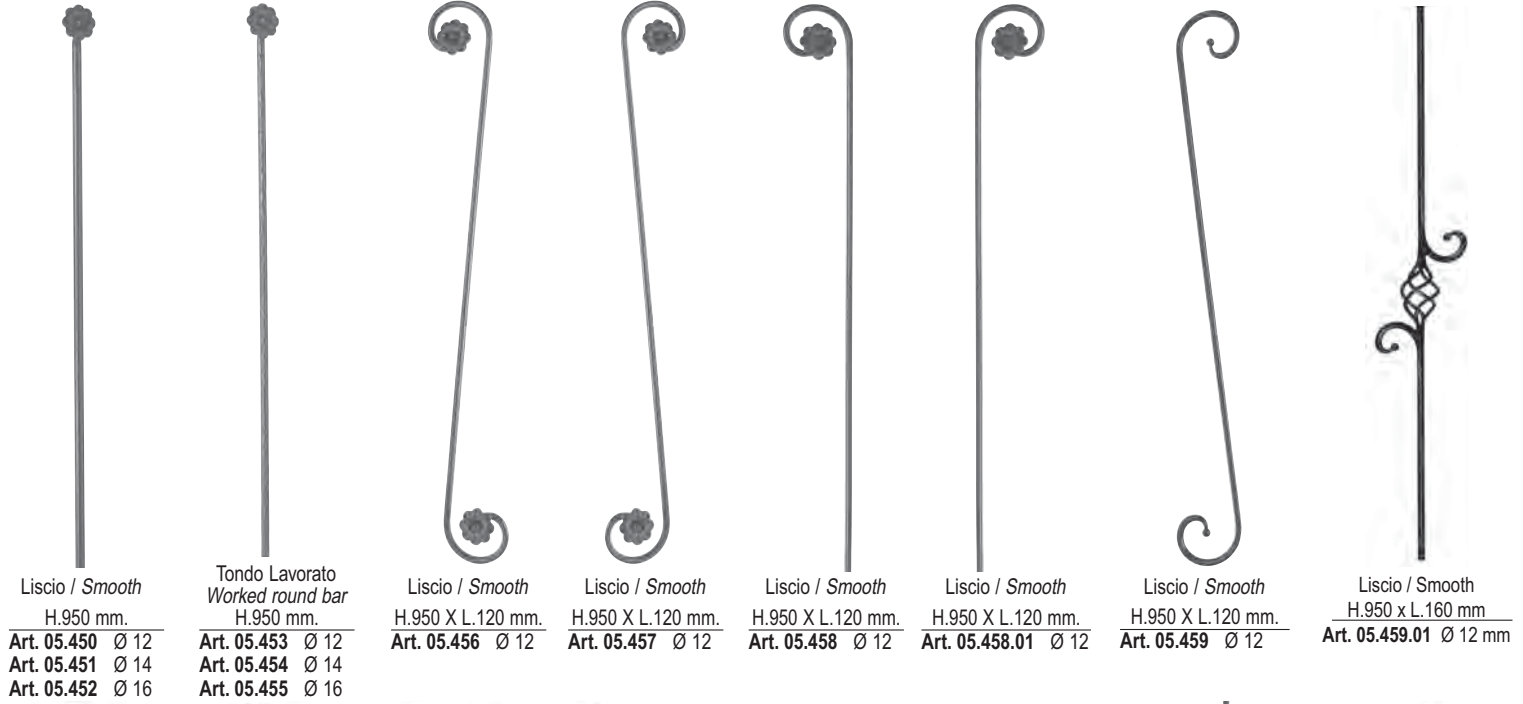

Tutte le parti di questo catalogo - foto comprese - sono di proprietà Euro-Fer. La riproduzione, anche parziale, è vietata in ogni forma e con ogni mezzo. / Every part of this catalogue - photos included - is Euro-Fer's property. All forms of copying are strictly prohibited.



Liscio / Smooth  
 H.950 X L.100 mm.  
 Art. 05.468 Ø 12



Liscio / Smooth  
 H.950 X L.125 mm.  
 Art. 05.469 Ø 12  
 Art. 05.469.01 Ø 14



Liscio / Smooth  
 H.950 X L.125 mm.  
 Art. 05.470 Ø 12  
 Art. 05.470.01 Ø 14



Liscio / Smooth  
 H.950 X L.130 mm.  
 Art. 05.471 Ø 12  
 Art. 05.471.01 Ø 14



Liscio / Smooth  
 H.950 X L.125 mm.  
 Art. 05.472 Ø 12  
 Art. 05.472.01 Ø 14



Liscio / Smooth  
 H.950 X L.125 mm.  
 Art. 05.473 Ø 12  
 Art. 05.473.01 Ø 10



Liscio / Smooth  
 H.950 X L.100 mm.  
 Art. 05.474 Ø 10



Liscio / Smooth  
 H.950 X L.100 mm.  
 Art. 05.475 Ø 10

Cerchio  
 Hole  
 Ø 90 mm  
 Cerchio  
 Hole  
 Ø 100 mm  
 Cerchio  
 Hole  
 Ø 90 mm



Liscio / Smooth  
 H.950 X L.140 mm.  
 Art. 05.476 Ø 10



Liscio / Smooth  
 H.950 X L.180 mm.  
 Art. 05.477 Ø 12



Liscio / Smooth  
 H.950 X L.75 mm.  
 Art. 05.478 Ø 10  
 Art. 05.478.01 Ø 12



Liscio / Smooth  
 H.950 X L.85 mm.  
 Art. 05.479 Ø 10  
 Art. 05.479.01 Ø 12

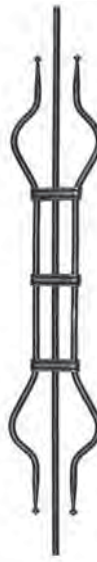

Liscio / Smooth  
 H.950 x L.150 mm  
 Art. 05.479.02  
 Ø 12 mm



Liscio / Smooth  
 H.1000 x L.45 mm  
 Art. 05.479.10  
 Ø 12 mm



Liscio / Smooth  
 H.1000 x L.45 mm  
 Art. 05.479.11  
 Ø 12 mm



Liscio / Smooth  
 H.1000 x L.45 mm  
 Art. 05.479.12  
 Ø 12 mm



Liscio / Smooth  
 H.1000 x L.45 mm  
 Art. 05.479.13  
 Ø 12 mm



Liscio / Smooth  
 H.1000 x L.130 mm  
 Art. 05.479.14  
 Ø 12 mm



Liscio / Smooth  
 H.1000 x L.45 mm  
 Art. 05.479.15  
 Ø 12 mm



Liscio / Smooth  
 H.1000 x L.55 mm  
 Art. 05.479.16  
 Ø 12 mm



Liscio / Smooth  
 H.1000 x L.85 mm  
 Art. 05.479.18  
 Ø 12 mm



Liscio / Smooth  
 H.1000 x L.85 mm  
 Art. 05.479.19  
 Ø 12 mm



Liscio / Smooth  
 H.1000 x L.65 mm  
 Art. 05.479.20  
 Ø 12 mm

Tutte le parti di questo catalogo - foto comprese - sono di proprietà Euro-Fer. La riproduzione, anche parziale, è vietata in ogni forma e con ogni mezzo. / Every part of this catalogue - photos included - is Euro-Fer's property. All forms of copying are strictly prohibited.



Liscio / Smooth  
H.1000 x L.120 mm

Art. 05.479.29  
□ 12 mm  
Art. 05.479.30  
□ 16 mm



Liscio / Smooth  
H.1000 x L.120 mm  
Art. 05.479.31  
□ 16 mm



Liscio / Smooth  
H.1000 x L.120 mm  
Art. 05.479.32  
□ 16 mm



Liscio / Smooth  
H.1000 x L.120 mm  
Art. 05.479.33  
□ 16 mm



Liscio / Smooth  
H.1000 x L.120 mm  
Art. 05.479.34  
□ 16 mm



Liscio / Smooth  
H.1000 x L.120 mm  
Art. 05.479.35  
□ 16 mm



NEW

Liscio / Smooth  
H.1000 x L.120 mm  
Art. 05.479.50 □ 12 mm  
Art. 05.479.51 □ 16 mm



NEW

Liscio / Smooth  
H.1000 x L.120 mm  
Art. 05.479.60  
□ 12 mm  
Art. 05.479.61  
□ 16 mm



Liscio / Smooth  
H.950 X L.175 mm.  
Art. 05.480 Ø 14



Liscio / Smooth  
H.950 X L.100 mm.  
Art. 05.481 Ø 12



Liscio / Smooth  
H.950 X L.100 mm.  
Art. 05.482 Ø 12



Liscio / Smooth  
H.950 X L.165 mm.  
Art. 05.483 Ø 12



Liscio / Smooth  
H.950 X L.165 mm.  
Art. 05.484 Ø 12



Liscio / Smooth  
H.950 X L.125 mm.  
Art. 05.485 Ø 12



Liscio / Smooth  
H.950 X L.130 mm.  
Art. 05.486 Ø 12



Liscio / Smooth  
H.950 X L.105 mm.  
Art. 05.487 Ø 12

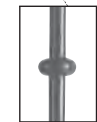
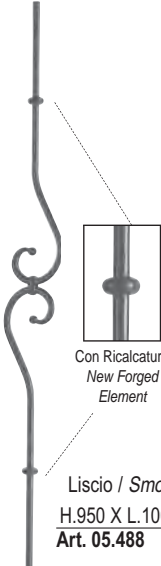

Con Ricalcatura  
New Forged  
Element

Liscio / Smooth  
H.950 X L.100 mm.  
Art. 05.488 Ø 12



Liscio / Smooth  
H.950 X L.125 mm.  
Art. 05.489 Ø 14



Liscio / Smooth  
H.950 X L.110 mm.  
Art. 05.490 Ø 14



Liscio / Smooth  
H.950 X L.155 mm.  
Art. 05.491 Ø 12



PANNELLI LISCI E PALETTI PER RECINZIONI  
PLAIN PANEL UNITS AND STAKES FOR FENCES

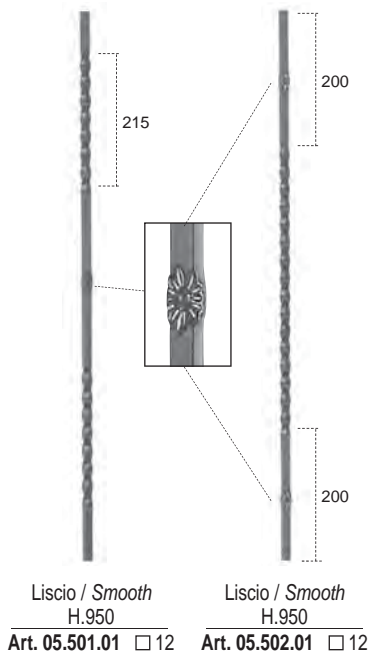
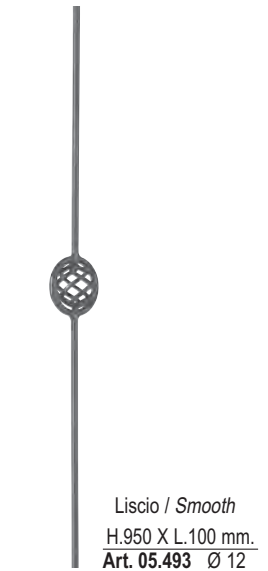
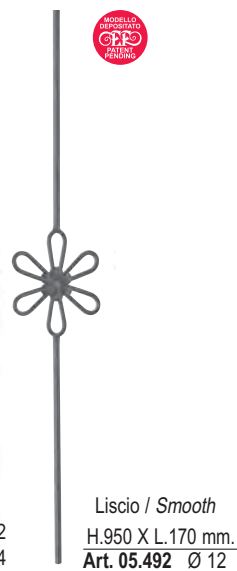
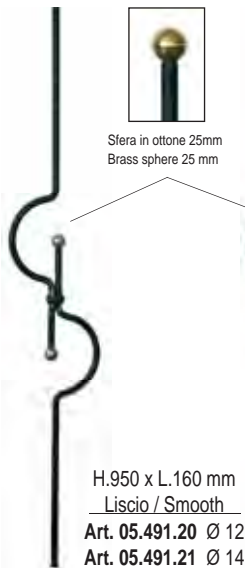
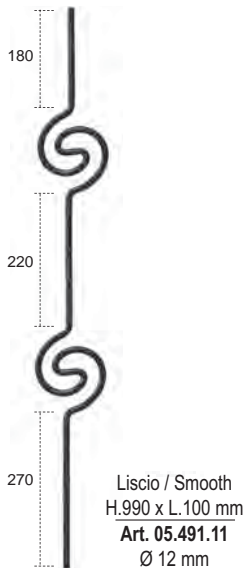
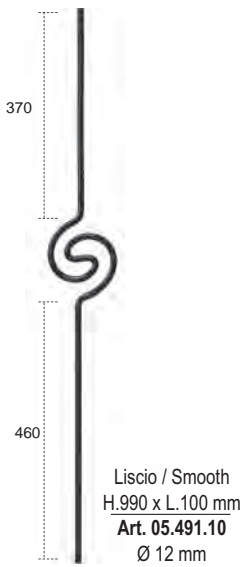



H.950 x L.115 mm  
Martellato / *Hammered*  
Art. 05.509.05 □ 12  
Liscio / *Smooth*  
Art. 05.509.06 □ 12



H.950 X L.90 mm.  
Art. 05.510 □ 12



H.950 X L.145 mm.  
Art. 05.511 □ 10



H.950 X L.140 mm.  
Art. 05.512 □ 12



H.950 X L.140 mm.  
Art. 05.513 □ 12



Liscio / *Smooth*  
H.1000 x L.120 mm  
Art. 05.513.100 □ 16  
Art. 05.513.101 □ 20



Liscio / *Smooth*  
H.1000 x L.120 mm  
Art. 05.513.102 □ 16



Liscio / *Smooth*  
H.1000 x L.120 mm  
Art. 05.513.103 □ 16



Liscio / *Smooth*  
H.1000 x L.135 mm  
Art. 05.513.104 □ 16  
Art. 05.513.105 □ 20



Liscio / *Smooth*  
H.1000 x L.120 mm  
Art. 05.513.106 □ 16



Liscio / *Smooth*  
H.1000 x L.155 mm  
Art. 05.513.107 □ 16



Liscio / *Smooth*  
H.1000 x L.165 mm  
Art. 05.513.108 □ 16



Liscio / *Smooth*  
H.1000 x L.135 mm  
Art. 05.513.109 □ 16



Liscio / *Smooth*  
H.1000 x L.200 mm  
Art. 05.513.110  
□ 16 ≠ 16 x 8



Liscio / *Smooth*  
H.1000 x L.190 mm  
Art. 05.513.111  
□ 16 ≠ 16 x 8



Liscio / *Smooth*  
H.1000 x L.140 mm  
Art. 05.513.112 □ 16



Liscio / *Smooth*  
H.950 X L.200 mm.  
Art. 05.515 □ 10



Liscio / *Smooth*  
H.950 X L.165 mm.  
Art. 05.516 □ 10



Liscio / *Smooth*  
H.950 X L.200 mm.  
Art. 05.517 □ 12

**PANNELLI LISCI E PALETTI PER RECINZIONI**  
**PLAIN PANEL UNITS AND STAKES FOR FENCES**



Con Ricalcatura  
New Forged  
Element



Liscio / Smooth  
H.950 X L.180 mm.  
Art. 05.519 □ 12



Liscio / Smooth  
H.950 X L.220 mm.  
Art. 05.520 □ 12  
≠ 12 x 6



Liscio / Smooth  
H.950 X L.175 mm.  
Art. 05.521 □ 10  
≠ 12 x 6

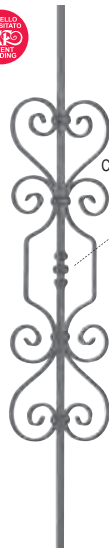

Liscio / Smooth  
H.950 X L.180 mm.  
Art. 05.522 □ 12



Liscio / Smooth  
H.950 mm.  
Art. 05.523 □ 12



Liscio / Smooth  
H.950 mm.  
Art. 05.523.01 □ 12



Martellato / Hammered  
H.950 mm.  
Art. 05.524 □ 12  
Art. 05.524.01 □ 14



Martellato / Hammered  
H.950 mm.  
Art. 05.524.02 □ 12  
Art. 05.524.03 □ 14



Liscio / Smooth  
H.950 mm.  
Art. 05.525 □ 12  
Art. 05.525.01 □ 14



Liscio / Smooth  
H.950 mm.  
Art. 05.525.02 □ 12  
Art. 05.525.03 □ 14



Liscio / Smooth  
H.950 x L.60 mm  
Art. 05.525.04  
□ 12 mm



Liscio / Smooth  
H.950 x L.60 mm  
Art. 05.525.06  
□ 12 mm



Liscio / Smooth  
H.950 x L.75 mm  
Art. 05.525.12  
□ 12



Liscio / Smooth  
H.950 mm.  
Art. 05.526 □ 14  
Art. 05.526.01 □ 12



Martellato / Hammered  
H.950 mm.  
Art. 05.527 □ 14  
Art. 05.527.01 □ 12

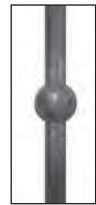

Sfera / Sphere  
Ø22



H 950 mm  
Art. 05.527.10 □ 12  
H 1000 mm  
Art. 05.527.11 □ 12



Sfera / Sphere Ø35

Art. 05.527.45 Ø12 H 950 mm  
Art. 05.527.46 Ø12 H 1000 mm  
Art. 05.527.47 Ø12 H 1200 mm

H 950 mm  
Art. 05.527.50 Ø16  
Art. 05.527.51 □ 12  
Art. 05.527.52 □ 14

H 1000 mm  
Art. 05.527.53 Ø16  
Art. 05.527.54 □ 12  
Art. 05.527.55 □ 14

H 1200 mm  
Art. 05.527.56 Ø16  
Art. 05.527.57 □ 12  
Art. 05.527.58 □ 14

H 1500 mm  
Art. 05.527.59 Ø16



Sfera / Sphere Ø30

Art. 05.527.60 Ø12 H 950 mm  
Art. 05.527.61 Ø12 H 1000 mm  
Art. 05.527.62 Ø12 H 1200 mm

Art. 05.527.64 Ø14 H 950 mm  
Art. 05.527.65 Ø14 H 1000 mm  
Art. 05.527.66 Ø14 H 1200 mm

Sfera / Sphere Ø25

H 950 mm  
Art. 05.527.70 Ø12  
Art. 05.527.71 Ø14

H 1000 mm  
Art. 05.527.73 Ø12  
Art. 05.527.74 Ø14

H 1200 mm  
Art. 05.527.76 Ø12  
Art. 05.527.77 Ø14

H 1500 mm  
Art. 05.527.79 Ø12  
Art. 05.527.80 Ø14

Art. 05.527.81 □ 12 H 950 mm  
Art. 05.527.82 □ 12 H 1000 mm  
Art. 05.527.83 □ 12 H 1200 mm

Sfera / Sphere Ø20

Art. 05.527.90 Ø12 H 950 mm  
Art. 05.527.91 Ø12 H 1000 mm  
Art. 05.527.92 Ø12 H 1200 mm





Sfera Forgiata Ø 25  
 / Forged Sphere Ø 25

Art. 05.527.100 Ø12 H 1000 mm



Lancia elettrosaldata /  
 Electro-welded spear

Lancia mod. /  
 Spear mod.  
 Art.13.072

Liscio / Smooth

H.950 mm.

Art. 05.528 □ 12  
 Art. 05.528.01 □ 14

H.1000 mm.

Art. 05.528.02 □ 12  
 Art. 05.528.03 □ 14

H.1200 mm.

Art. 05.528.04 □ 12  
 Art. 05.528.05 □ 14

H.1500 mm.

Art. 05.528.06 □ 12  
 Art. 05.528.07 □ 14



Lancia elettrosaldata /  
 Electro-welded spear

Lancia mod. /  
 Spear mod.  
 Art.13.060.02

Liscio / Smooth

H.950 mm.

Art. 05.529 □ 12  
 Art. 05.529.01 □ 14

H.1000 mm.

Art. 05.529.02 □ 12  
 Art. 05.529.03 □ 14

H.1200 mm.

Art. 05.529.04 □ 12  
 Art. 05.529.05 □ 14

H.1500 mm.

Art. 05.529.06 □ 12  
 Art. 05.529.07 □ 14



Lancia elettrosaldata /  
 Electro-welded spear

Lancia mod. /  
 Spear mod.  
 Art.13.056

Liscio / Smooth

H.950 mm.

Art. 05.530 Ø 12  
 Art. 05.530.01 Ø 14

H.1000 mm.

Art. 05.530.02 Ø 12  
 Art. 05.530.03 Ø 14

H.1200 mm.

Art. 05.530.04 Ø 12  
 Art. 05.530.05 Ø 14

H.1500 mm.

Art. 05.530.06 Ø 12  
 Art. 05.530.07 Ø 14



Lancia elettrosaldata /  
 Electro-welded spear

Lancia mod. /  
 Spear mod.  
 Art.13.098.02

Liscio / Smooth

H.950 mm.

Art. 05.531 □ 12  
 Art. 05.531.01 Ø 14

H.1000 mm.

Art. 05.531.02 Ø 12  
 Art. 05.531.03 Ø 14

H.1200 mm.

Art. 05.531.04 Ø 12  
 Art. 05.531.05 Ø 14

H.1500 mm.

Art. 05.531.06 Ø 12  
 Art. 05.531.07 Ø 14



Lancia elettrosaldata /  
 Electro-welded spear

Lancia mod. /  
 Spear mod.  
 Art.13.092

Liscio / Smooth

H.950 mm

Art. 05.531.08 □ 12 mm  
 Art. 05.531.09 □ 14 mm

H.1000 mm

Art. 05.531.10 □ 12 mm  
 Art. 05.531.11 □ 14 mm

H.1200 mm

Art. 05.531.12 □ 12 mm  
 Art. 05.531.13 □ 14 mm

H.1500 mm

Art. 05.531.14 □ 12 mm  
 Art. 05.531.15 □ 14 mm



Lancia elettrosaldata /  
 Electro-welded spear

Lancia mod. /  
 Spear mod.  
 Art.13.077

H.950 mm

Art. 05.531.16 □ 12 mm  
 Art. 05.531.17 □ 14 mm

H.1000 mm

Art. 05.531.18 □ 12 mm  
 Art. 05.531.19 □ 14 mm

H.1200 mm

Art. 05.531.20 □ 12 mm  
 Art. 05.531.21 □ 14 mm

H.1500 mm

Art. 05.531.22 □ 12 mm  
 Art. 05.531.23 □ 14 mm



Lancia elettrosaldata /  
 Electro-welded spear

Lancia mod. /  
 Spear mod.  
 Art.13.061

H.950 mm

Art. 05.531.24 Ø 16 mm

H.1000 mm

Art. 05.531.25 Ø 16 mm

H.1200 mm

Art. 05.531.26 Ø 16 mm

H.1500 mm

Art. 05.531.27 Ø 16 mm

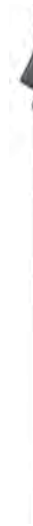

Lancia elettrosaldata /  
 Electro-welded spear

Lancia mod. /  
 Spear mod.  
 Art.13.077.06

H.950 mm

Art. 05.531.28 Ø 12 mm  
 Art. 05.531.29 Ø 14 mm

H.1000 mm

Art. 05.531.30 Ø 12 mm  
 Art. 05.531.31 Ø 14 mm

H.1200 mm

Art. 05.531.32 Ø 12 mm  
 Art. 05.531.33 Ø 14 mm

H.1500 mm

Art. 05.531.34 Ø 12 mm  
 Art. 05.531.35 Ø 14 mm



Art. 05.531.80  
 □ 12 H 950 mm  
 Art. 05.531.81  
 □ 12 H 1000 mm  
 Art. 05.531.82  
 □ 12 H 1200 mm



Art. 05.531.100  
 Ø 12 H 1000 mm  
 Art. 05.531.101  
 Ø 12 H 1200 mm



Art. 05.531.110  
 □ 12 H 1000 mm  
 Art. 05.531.111  
 □ 12 H 1200 mm



Art. 05.531.116  
 Ø 12 H 1000 mm  
 Art. 05.531.117  
 Ø 12 H 1200 mm



Art. 05.531.120  
 Ø 12 H 1000 mm  
 Art. 05.531.121  
 Ø 12 H 1200 mm

Tutte le parti di questo catalogo - foto comprese - sono di proprietà Euro-Fer. La riproduzione, anche parziale, è vietata in ogni forma e con ogni mezzo. / Every part of this catalogue - photos included - is Euro-Fer's property. All forms of copying are strictly prohibited.

PANNELLI LISCI E PALETTI PER RECINZIONI  
PLAIN PANEL UNITS AND STAKES FOR FENCES

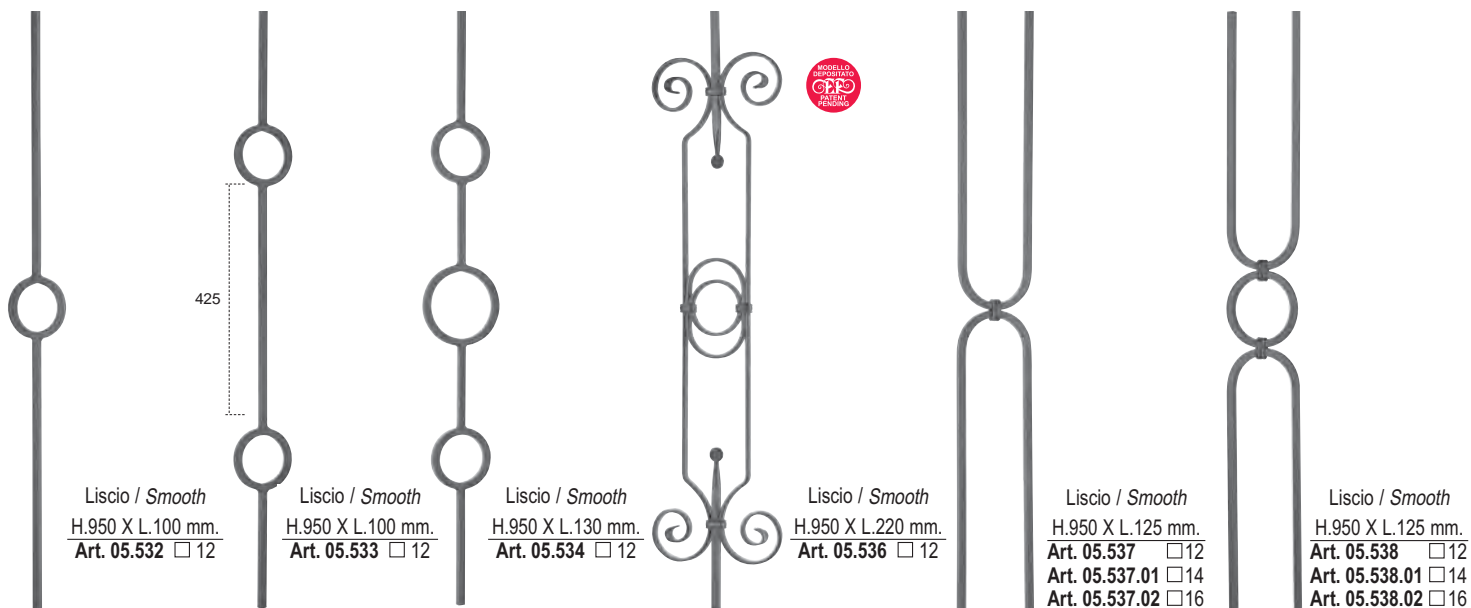

Liscio / Smooth  
H.950 X L.100 mm.  
Art. 05.532 □ 12

Liscio / Smooth  
H.950 X L.100 mm.  
Art. 05.533 □ 12

Liscio / Smooth  
H.950 X L.130 mm.  
Art. 05.534 □ 12

Liscio / Smooth  
H.950 X L.220 mm.  
Art. 05.536 □ 12

Liscio / Smooth  
H.950 X L.125 mm.  
Art. 05.537 □ 12  
Art. 05.537.01 □ 14  
Art. 05.537.02 □ 16

Liscio / Smooth  
H.950 X L.125 mm.  
Art. 05.538 □ 12  
Art. 05.538.01 □ 14  
Art. 05.538.02 □ 16

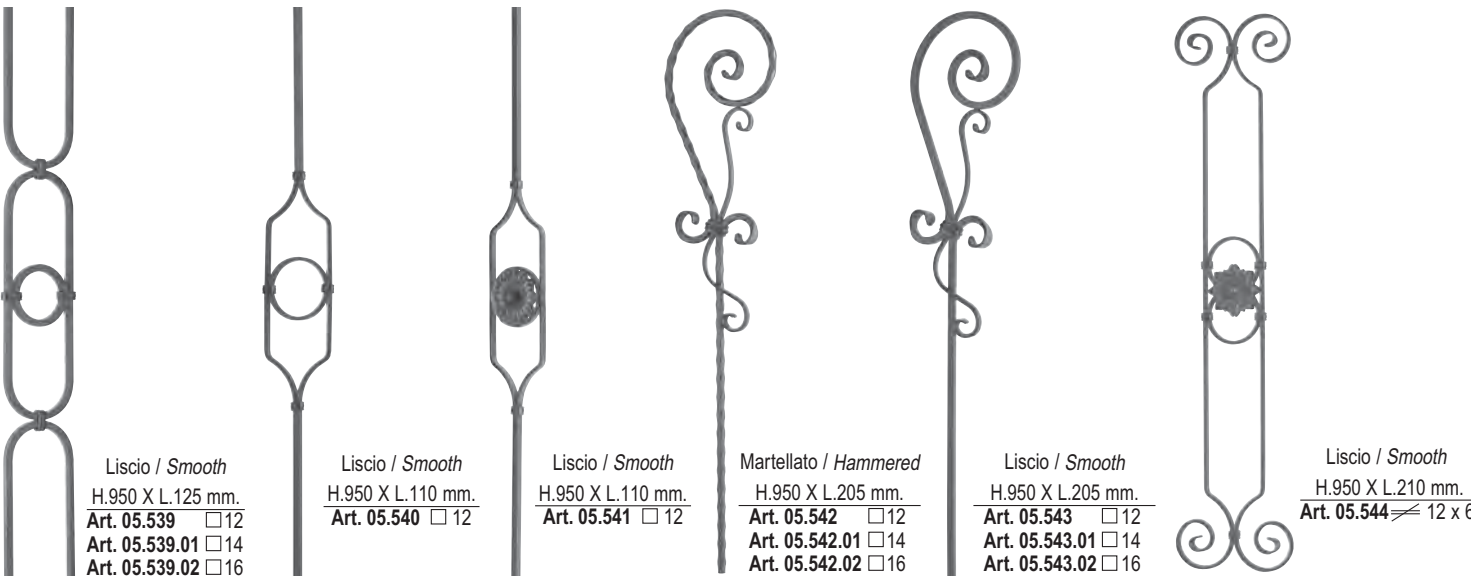

Liscio / Smooth  
H.950 X L.125 mm.  
Art. 05.539 □ 12  
Art. 05.539.01 □ 14  
Art. 05.539.02 □ 16

Liscio / Smooth  
H.950 X L.110 mm.  
Art. 05.540 □ 12

Liscio / Smooth  
H.950 X L.110 mm.  
Art. 05.541 □ 12

Martellato / Hammered  
H.950 X L.205 mm.  
Art. 05.542 □ 12  
Art. 05.542.01 □ 14  
Art. 05.542.02 □ 16

Liscio / Smooth  
H.950 X L.205 mm.  
Art. 05.543 □ 12  
Art. 05.543.01 □ 14  
Art. 05.543.02 □ 16

Liscio / Smooth  
H.950 X L.210 mm.  
Art. 05.544 ≠ 12 x 6

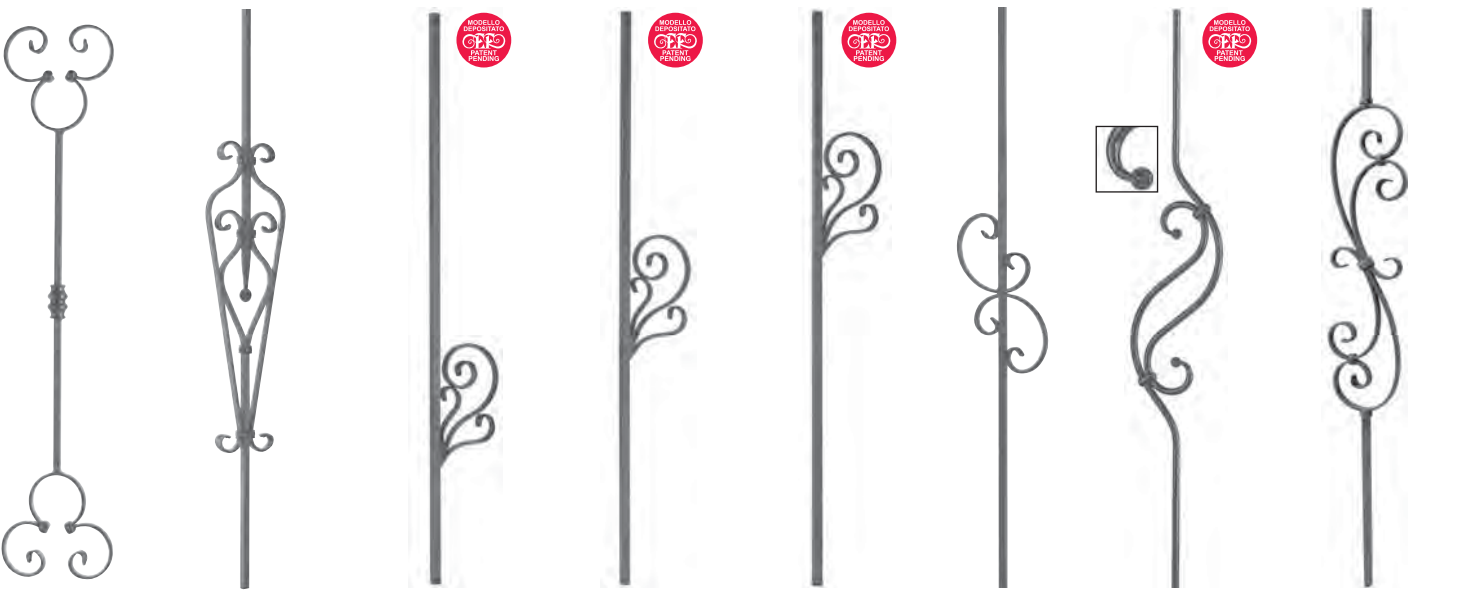

Liscio / Smooth  
H. 950 x 190 mm  
Art. 05.545 □ 12  
≠ 12 X 6

Liscio / Smooth  
H. 950 x 150 mm  
Art. 05.546 □ 12

Liscio / Smooth  
H.950 X L.120 mm.  
Art. 05.547 □ 14

Liscio / Smooth  
H.950 X L.120 mm.  
Art. 05.548 □ 14

Liscio / Smooth  
H.950 X L.120 mm.  
Art. 05.549 □ 14

Liscio / Smooth  
H.950 X L.120 mm.  
Art. 05.550 □ 12

Liscio / Smooth  
H.950 X L.160 mm.  
Art. 05.551 Ø 12

Liscio / Smooth  
H.950 X L.180 mm.  
Art. 05.552 ≠ 12 x 6  
□ 12

Tutte le parti di questo catalogo - foto comprese - sono di proprietà Euro-Fer. La riproduzione, anche parziale, è vietata in ogni forma e con ogni mezzo. / Every part of this catalogue - photos included - is Euro-Fer's property. All forms of copying are strictly prohibited.

**PS**  
 pallina "a sole"  
 sun ball



Martellato / *Hammered*

- H.950 mm.  
 Art. 05.553 □ 12  
 Art. 05.553.01 □ 14  
 Art. 05.553.02 Ø 12  
 Art. 05.553.03 Ø 14
- H.1000 mm.  
 Art. 05.553.04 □ 12  
 Art. 05.553.05 □ 14  
 Art. 05.553.06 Ø 12  
 Art. 05.553.07 Ø 14
- H.1200 mm.  
 Art. 05.553.08 □ 12  
 Art. 05.553.09 □ 14  
 Art. 05.553.10 Ø 12  
 Art. 05.553.11 Ø 14
- H.1500 mm.  
 Art. 05.553.12 □ 12  
 Art. 05.553.13 □ 14  
 Art. 05.553.14 Ø 12  
 Art. 05.553.15 Ø 14

Liscio / *Smooth*

- H.950 mm.  
 Art. 05.554 □ 12  
 Art. 05.554.01 □ 14  
 Art. 05.554.02 Ø 12  
 Art. 05.554.03 Ø 14
- H.1000 mm.  
 Art. 05.554.04 □ 12  
 Art. 05.554.05 □ 14  
 Art. 05.554.06 Ø 12  
 Art. 05.554.07 Ø 14
- H.1200 mm.  
 Art. 05.554.08 □ 12  
 Art. 05.554.09 □ 14  
 Art. 05.554.10 Ø 12  
 Art. 05.554.11 Ø 14
- H.1500 mm.  
 Art. 05.554.12 □ 12  
 Art. 05.554.13 □ 14  
 Art. 05.554.14 Ø 12  
 Art. 05.554.15 Ø 14

Tondo Lavorato  
*Worked Round Bar*

- H.950 mm.  
 Art. 05.555 Ø 12  
 Art. 05.555.01 Ø 14
- H.1000 mm.  
 Art. 05.555.02 Ø 12  
 Art. 05.555.03 Ø 14
- H.1200 mm.  
 Art. 05.555.04 Ø 12  
 Art. 05.555.05 Ø 14
- H.1500 mm.  
 Art. 05.555.06 Ø 12  
 Art. 05.555.07 Ø 14

Liscio / *Smooth*

- H.950 mm.  
 Art. 05.556 Ø 12  
 Art. 05.556.01 Ø 14
- H.1000 mm.  
 Art. 05.556.02 Ø 12  
 Art. 05.556.03 Ø 14
- H.1200 mm.  
 Art. 05.556.04 Ø 12  
 Art. 05.556.05 Ø 14
- H.1500 mm.  
 Art. 05.556.06 Ø 12  
 Art. 05.556.07 Ø 14



**NEW**



Liscio / *Smooth*  
 H.950 X L.250 mm.  
 Art. 05.560 Ø 10  
 Art. 05.560.01 Ø 12



Liscio / *Smooth*  
 H.950 x L.420 mm  
 Art. 05.560.02 Ø 12 mm

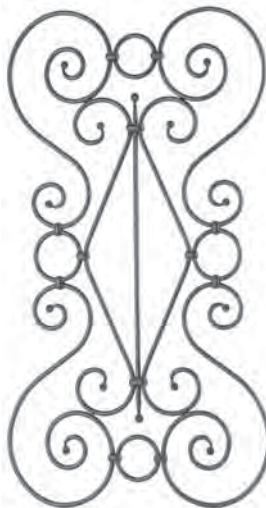

Liscio / *Smooth*  
 H.950 X L.520 mm.  
 Art. 05.561 Ø 10  
 Art. 05.561.01 Ø 12



Liscio / *Smooth*  
 H.950 x L.420 mm  
 Art. 05.561.02 Ø 12  
 Con fiori su ambo i lati /  
 Flowers on both sides

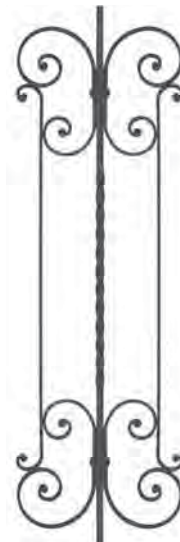

Liscio / *Smooth*  
 H.1000 x L.310 mm  
 Art. 05.561.05  
 □ 12 mm ≠ 12 x 6 mm



Liscio / *Smooth*  
 H.900 X L.175 mm.  
 Art. 05.562 Ø 12

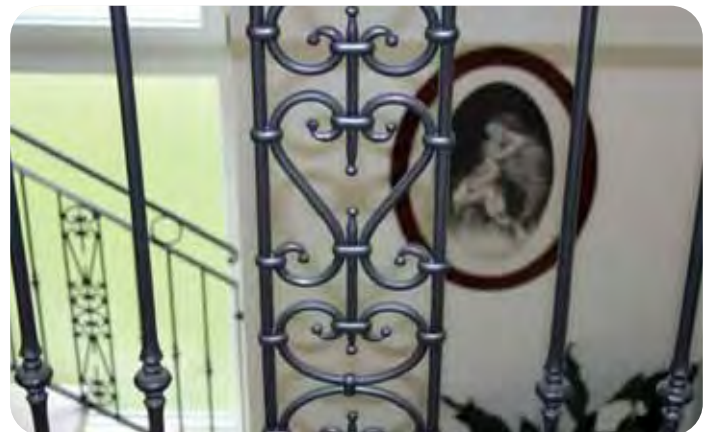

Tutte le parti di questo catalogo - foto comprese - sono di proprietà Euro-Fer. La riproduzione, anche parziale, è vietata in ogni forma e con ogni mezzo. / Every part of this catalogue - photos included - is Euro-Fer's property. All forms of copying are strictly prohibited.





NEW



NEW



NEW



Art. 05.562.20

Liscio / Smooth  
H.1200 x L.420 mm ca.  
Rosa / Rose Ø 10 mm  
Paletto / Bar Ø 12 mm

Art. 05.562.21

Martellato / Hammered  
H.1200 x L.420 mm ca.  
Rosa / Rose Ø 12 mm  
Paletto / Bar Ø 12 mm

Art. 05.562.22

Modello Corteccia / Bark Model  
H.1200 x L.420 mm ca.  
Rosa / Rose Ø 12 mm  
Paletto / Bar Ø 12 mm

Art. SW 05.562.20

Liscio / Smooth  
H.1200 x L.420 mm ca.  
Rosa / Rose Ø 10 mm  
Paletto / Bar Ø 12 mm

Art. 05.563.20

Liscio / Smooth  
H.1200 x L.420 mm ca.  
Rosa / Rose □ 10 mm  
Paletto / Bar □ 12 mm

Art. SW 05.563.20

Liscio / Smooth  
H.1200 x L.420 mm ca.  
Rosa / Rose □ 10 mm  
Paletto / Bar □ 12 mm



ROSE COLLECTION  
CRYSTALS FROM SWAROVSKI\*

ROSE COLLECTION  
CRYSTALS FROM SWAROVSKI\*

NEW

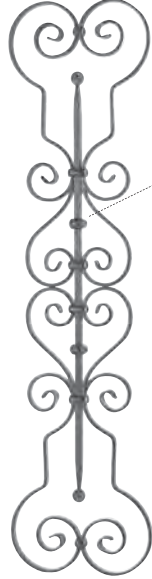

Con Ricalcatura  
New Forged  
Element



Liscio / Smooth

H. 1000 X L. 400 mm  
Art. 05.562.25  
Rosa/rose Ø 12

Liscio / Smooth

H.950 X L. 120 mm.  
Art. 05.563 Ø 12

Liscio / Smooth

H.950 X L. 120 mm.  
Art. 05.564 Ø 12

Liscio / Smooth

H.950 X L.245mm.  
Art. 05.565 12 x 6  
□ 12

Liscio / Smooth

H.950 x L.190 mm  
Art. 05.566 Ø 12  
Art. 05.567 □ 12

Liscio / Smooth

H.950 x L.240 mm  
Art. 05.568 Ø 12  
Art. 05.569 □ 12

Liscio / Smooth

H.950 x L.210 mm  
Art. 05.570 Ø 12



Liscio / Smooth  
 H.950 x L.230 mm  
**Art. 05.590** Ø 12  
 Con fiori su ambo i lati /  
 Flowers on both sides



Rigato / Fluted  
 H.950 x L.100 mm  
**Art. 05.591** □ 14  
**Art. 05.591.01** □ 12  
 Con fiori su ambo i lati /  
 Flowers on both sides



Profilo a nuvola /  
 Cloud profile

Profilo nuvola /  
 Cloud profile  
 H.950 mm  
**Art. 05.592** ≇ 20 x 12



Profilo nuvola /  
 Cloud profile  
 H.950 mm  
**Art. 05.592.01** ≇ 20 x 12



Forgiato / Forged  
 H.950 mm  
**Art. 05.593** □ 14



Pigna schiacciata /  
 Flatted Basket

Forgiato / Forged  
 H.950 mm  
**Art. 05.593.01** □ 14

Con borchia in Acciaio Fuso / With Cast Steel stud Art.CI.13.921



Liscio / Smooth  
 H.950 x L.114 mm  
**Art. 05.600** □ 14



Liscio / Smooth  
 H.950 mm  
**Art. 05.700** Ø 16 x 1,5  
 Tubo / Pipe bar



Liscio / Smooth  
 H.950 mm  
**Art. 05.701** Ø 16 x 1,5  
 Tubo / Pipe bar



Liscio / Smooth  
 H.950 mm  
**Art. 05.702** Ø 16 x 1,5  
 Tubo / Pipe bar



Liscio / Smooth  
 H.1750 x L.320 mm  
**Art. 05.729.08**  
 □ 20 mm ≇ 16 x 8 mm



Liscio / Smooth  
 H.1750 x L.320 mm  
**Art. 05.729.09**  
 □ 20 mm ≇ 16 x 8 mm

🌀 fiori da entrambi i lati / flowers on both sides

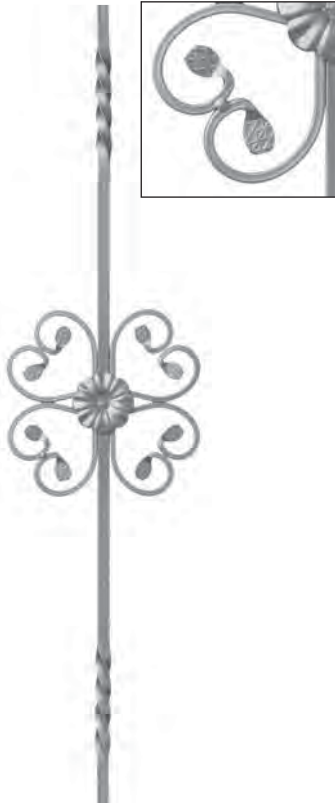

🌀 Liscio / Smooth  
H. 950 X L. 190 mm.  
Art. 05.800  
□ 12  
≠ 12 x 6



Liscio / Smooth  
H. 950 X L. 210 mm.  
Art. 05.801  
Ø 12



🌀 Liscio / Smooth  
H. 950 X L. 150 mm.  
Art. 05.802  
□ 12  
Ø 12



🌀 Liscio / Smooth  
H. 950 X L. 150 mm.  
Art. 05.803  
Ø 12



Liscio / Smooth  
H. 950 X L. 150 mm.  
Art. 05.804  
Ø 10



Liscio / Smooth  
H. 950 X L. 160 mm.  
Art. 05.805  
□ 12  
≠ 12 x 6



Liscio / Smooth  
H. 950 X L. 205 mm.  
Art. 05.806  
□ 10  
≠ 10 x 5



Liscio / Smooth  
H. 950 X L. 95 mm.  
Art. 05.807  
□ 12  
≠ 12 x 6



Liscio / Smooth  
H. 950 X L. 95 mm.  
Art. 05.808  
□ 12  
≠ 12 x 6



Liscio / Smooth  
H. 950 X L. 135 mm.  
Art. 05.809  
□ 12  
≠ 12 x 6

Tutte le parti di questo catalogo - foto comprese - sono di proprietà Euro-Fer. La riproduzione, anche parziale, è vietata in ogni forma e con ogni mezzo. / Every part of this catalogue - photos included - is Euro-Fer's property. All forms of copying are strictly prohibited.



🌀 fiori da entrambi i lati / flowers on both sides

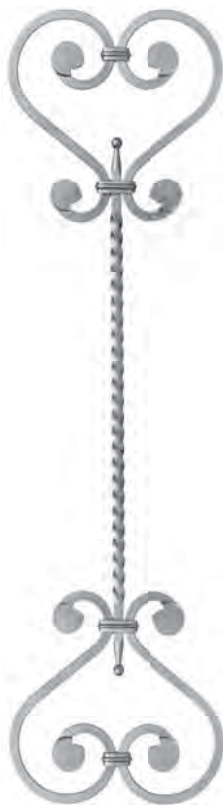

Liscio / Smooth  
 H. 820 X L. 220 mm.  
**Art. 05.810**  
 □ 10

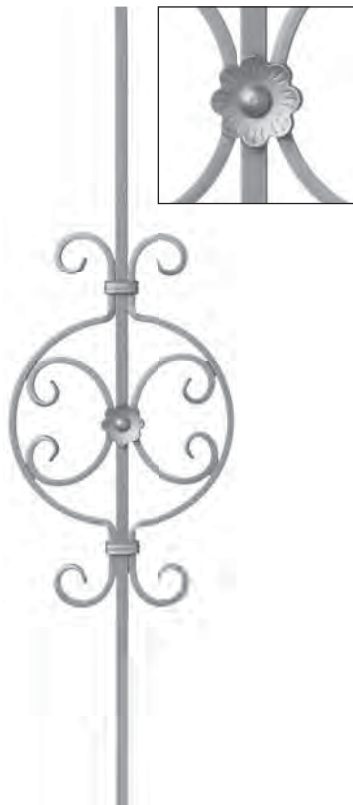

🌀 Liscio / Smooth  
 H. 950 X L. 255 mm.  
**Art. 05.811** □ 14 ≠ 14 x 6  
**Art. 05.811.01** □ 16 ≠ 16 x 8



Liscio / Smooth  
 H. 950 X L. 215 mm.  
**Art. 05.812**  
 □ 12 ≠ 12 x 6



Liscio / Smooth  
 H. 950 X L. 130 mm.  
**Art. 05.813**  
 □ 12 ≠ 12 x 6



🌀 Liscio / Smooth  
 H. 950 X L. 95 mm.  
**Art. 05.825**  
 □ 12 ≠ 12 x 6



Liscio / Smooth  
 H. 1000 X L. 70 mm.  
**Art. 05.826**  
 □ 12 pigna / basket □ 12



Liscio / Smooth  
 H. 950 X L. 130 mm.  
**Art. 05.827**  
 □ 12

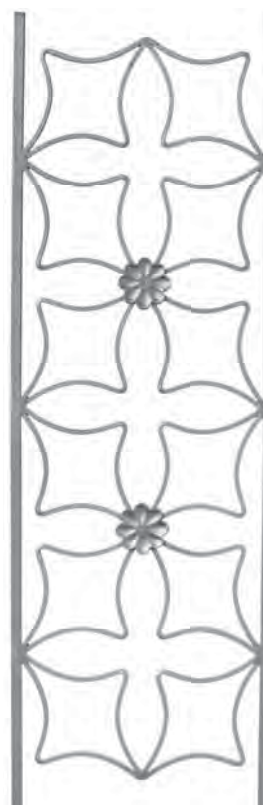

🌀 Liscio / Smooth  
 H. 950 X L. 300 mm.  
**Art. 05.828**  
 □ 12 ≠ 12 x 6

🌀 fiori da entrambi i lati / flowers on both sides

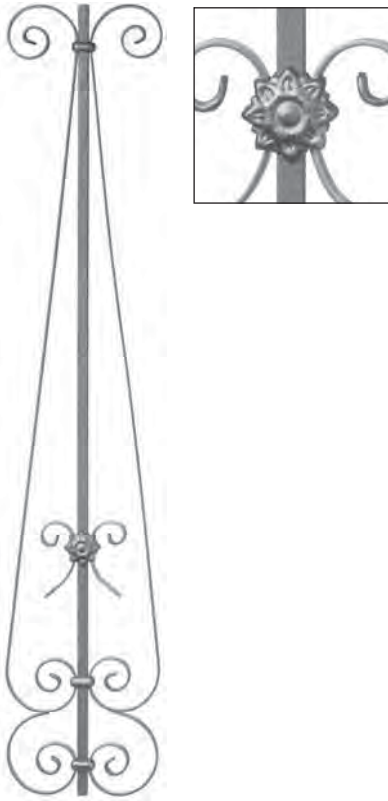

🌀 Liscio / Smooth  
H. 1220 X L. 235 mm.  
Art. 05.829  
□ 16  
≠ 16 x 4



Liscio / Smooth  
H. 950 X L. 125 mm.  
Art. 05.830  
□ 12  
≠ 12 x 4



Liscio / Smooth  
H. 950 X L. 120 mm.  
Art. 05.831  
□ 12  
≠ 12 x 4



Liscio / Smooth  
H. 950 X L. 170 mm.  
Art. 05.832  
□ 12  
≠ 12 x 6



H. 100 X L. 100 mm.  
Art. 02.050.50 ≠ 14 x 6



H. 110 X L. 110 mm.  
Art. 02.050.51 ≠ 12 x 6

H. 200 X L. 200 mm.  
Art. 02.051 □ 8 X 8  
Art. 02.052 □ 10 X 10  
Art. 02.053 □ 12 X 12

H. 80 X L. 80 mm.  
Art. 02.050.54 ≠ 12 x 6



H. 110 X L. 110 mm.  
Art. 02.050.55 ≠ 12 x 6





H.220 X L.220 mm.  
Art. 02.050.56  $\neq$  12 x 6

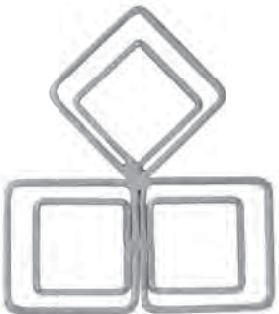

H.250 X L.220 mm.  
Art. 02.050.60  $\neq$  12 x 6



Liscio / Smooth  
H. 950 X L. 110 mm.  
Art. 05.833  
 $\square$  12  
 $\neq$  12 x 6



Liscio / Smooth  
H. 950 X L. 110 mm.  
Art. 05.834  
 $\square$  12  
 $\neq$  12 x 6



Liscio / Smooth  
H. 950 X L. 110 mm.  
Art. 05.835  
 $\square$  12  
 $\neq$  12 x 6



Liscio / Smooth  
H. 950 X L. 110 mm.  
Art. 05.836  
 $\square$  12  
 $\neq$  12 x 6



Liscio / Smooth  
H. 950 X L. 110 mm.  
Art. 05.837  
 $\square$  12  
 $\neq$  12 x 6



Liscio / Smooth  
H. 950 X L. 110 mm.  
Art. 05.838  
 $\square$  12  
 $\neq$  12 x 6



Liscio / Smooth  
H. 950 X L. 110 mm.  
Art. 05.839  
 $\square$  12  
 $\neq$  12 x 6

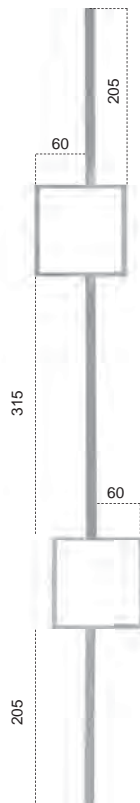

Liscio / Smooth  
H. 950 X L. 110 mm.  
Art. 05.840  
 $\square$  12  
 $\neq$  12 x 6



Liscio / Smooth  
H. 950 X L. 110 mm.  
Art. 05.841  
 $\square$  12  
 $\neq$  12 x 6



Liscio / Smooth  
H. 950 X L. 220 mm.  
Art. 05.842  
 $\square$  12  
 $\neq$  12 x 6



🌀 fiori da entrambi i lati / flowers on both sides



Liscio / Smooth  
H. 1000 X L. 183 mm.  
Art. 05.843  
spessore / thickness 6 mm



Liscio / Smooth  
H. 950 X L. 150 mm.  
Art. 05.844  
□ 12 ≠ 12 x 6



Liscio / Smooth  
H. 950 X L. 100 mm.  
Art. 05.845  
Ø 12



🌀 Liscio / Smooth  
H. 950 X L. 100 mm.  
Art. 05.846  
Ø 12

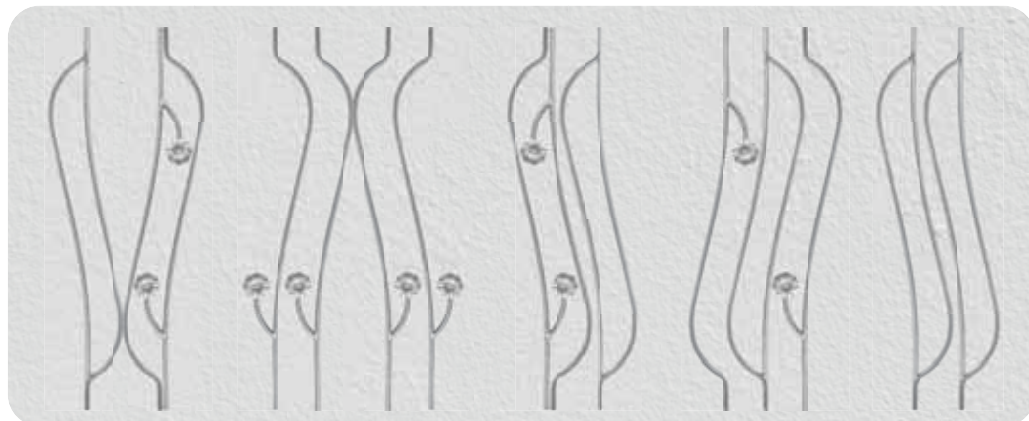

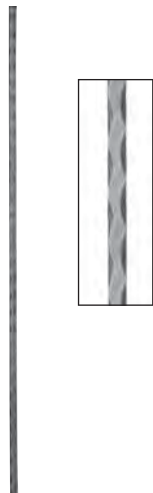

Mart./Hammered  
H.950 mm.  
Art. 06.001  12  
Art. 06.002  14



Mart./Hammered  
H.950 mm.  
Art. 06.003  
 12 X 12



Mart./Hammered  
H.950 mm.  
Art. 06.004  
 12 X 12



Mart./Hammered  
H.950 mm.  
Art. 06.005  
 12 X 12



Mart./Hämmered  
H.950 mm.  
Art. 06.006  
 12 X 12



Mart./Hämmered  
H.950 mm.  
Art. 06.007  
 12 X 12



Mart./Hammered  
H.950 mm.  
Art. 06.008  12  
Art. 06.008.01  14  
Art. 06.008.ES  12  
Art. 06.008.01.ES  14



Mart./Hammered  
H.950 mm.  
Art. 06.009  12  
Art. 06.009.01  14  
Art. 06.009.ES  12  
Art. 06.009.01.ES  14



Mart./Hammered  
H.950 X L.130 mm.  
Art. 06.010  
 12  12 X 6



Mart./Hammered  
H.950 X L.200 mm.  
Art. 06.011  
 12  12 X 6



Mart./Hammered  
H.950 X L.150 mm.  
Art. 06.012  
 12  12 X 6  
Liscio / Smooth  
Art. 06.012.01  
 12  12 X 6



Mart./Hammered  
H.950 X L.150 mm.  
Art. 06.013  
 12  12 X 6  
Liscio / Smooth  
Art. 06.013.01  
 12  12 X 6



Mart./Hammered  
H.950 X L.140 mm.  
Art. 06.014  
 12  12 X 6  
Art. 06.014.01  
 14  14 X 6



Mart./Hammered  
H.950 X L.135 mm.  
Art. 06.015  
 12  12 X 6



Mart./Hammered  
H.950 X L.170 mm.  
Art. 06.016  
 12  12 X 6



Mart./Hammered  
H.950 X L.170 mm.  
Art. 06.017  
 12  12 X 6



Mart./Hammered  
H.950 X L.135 mm.  
Art. 06.018  
 12  12 X 6



Mart./Hammered  
H.950 X L.120 mm.  
Art. 06.019  
 12  12 X 6



Mart./Hammered  
H.950 X L.170 mm.  
Art. 06.020  
 12  12 X 6



Art. 06.021

Tutte le parti di questo catalogo - foto comprese - sono di proprietà Euro-Fer. La riproduzione, anche parziale, è vietata in ogni forma e con ogni mezzo. / Every part of this catalogue - photos included - is Euro-Fer's property. All forms of copying are strictly prohibited.

**PANNELLI MARTELLATI  
HAMMERED PANELS**



Mart./Hammered  
H.950 X L.165 mm.  
**Art. 06.023**  
□ 12 ≠ 12 X 6



Mart./Hammered  
H. 950 X L.165 mm.  
**Art. 06.024**  
□ 12 ≠ 12 x 6 mm



H.950 X L.185 mm.  
**Art. 06.025**  
□ 12 X 12  
Mart./Hammered



H.950 X L.160 mm.  
**Art. 06.026**  
□ 12 ≠ 12 X 6  
Mart./Hammered



H.950 X L.220 mm.  
**Art. 06.027**  
□ 12 ≠ 12 X 6  
Mart./Hammered



H.950 mm.  
**Art. 06.028**  
□ 12 X 12  
Mart./Hammered



Mart./Hammered  
H.950 X L.150 mm.  
**Art. 06.029**  
□ 12 ≠ 12 X 6



Mart./Hammered  
H.950 X L.215 mm.  
**Art. 06.029.01**  
□ 12 ≠ 12 X 6  
**Art. 06.029.08**  
□ 14 ≠ 14 X 6  
**Art. 06.029.09**  
□ 16 ≠ 16 X 6



Mart./Hammered  
H.950 X L.275 mm.  
**Art. 06.029.02**  
□ 12 ≠ 12 X 6  
**Art. 06.029.10**  
□ 14 ≠ 14 X 6  
**Art. 06.029.11**  
□ 16 ≠ 16 X 6



Mart./Hammered  
H.950 X L.275 mm.  
**Art. 06.029.03**  
□ 12 ≠ 12 X 6  
**Art. 06.029.12**  
□ 14 ≠ 14 X 6  
**Art. 06.029.13**  
□ 16 ≠ 16 X 6



Martellato/Hammered  
H.950 X L.115 mm.  
**Art. 06.029.04**  
□ 12 ≠ 12 X 6



Martellato/Hammered  
H.950 X L.200 mm.  
**Art. 06.029.05**  
□ 14 ≠ 14 X 6



Martellato/Hammered  
H.950 X L.215 mm.  
**Art. 06.029.06**  
□ 14 ≠ 14 X 6



Martellato/Hammered  
H.950 X L.205 mm.  
**Art. 06.029.07**  
□ 14 ≠ 14 X 6



Martellato / Hammered  
H.950 x L.260 mm  
**Art. 06.029.14**  
□ 12 mm ≠ 12 x 6



Martellato kigato / Hammered Fluted  
H.950 x L.210 mm  
**Art. 06.029.15**  
□ 12 mm ≠ 12 x 6



Mart. / Hammered  
H.1000 mm.  
**Art. 06.030** □ 12  
**Art. 06.031** □ 14  
**Art. 06.032** □ 16



Liscio / Smooth  
H.1000 mm.  
**Art. 06.030.01** □ 12  
**Art. 06.030.02** □ 14  
**Art. 06.030.03** □ 16



Tondo / Round  
H.1200 mm.  
**Art. 06.032.01** Ø 12  
**Art. 06.032.02** Ø 14  
**Art. 06.032.03** Ø 16



Liscio / Smooth  
H.1200 mm.  
**Art. 06.032.04** □ 12  
**Art. 06.032.05** □ 14  
**Art. 06.032.06** □ 16



Batt. 4 lati/Beaten on 4 sides  
H.1200 mm.  
**Art. 06.032.07** □ 12  
**Art. 06.032.08** □ 14  
**Art. 06.032.09** □ 16  
H.1500 mm.  
**Art. 06.032.10** □ 16

Tutte le parti di questo catalogo - foto comprese - sono di proprietà Euro-Fer. La riproduzione, anche parziale, è vietata in ogni forma e con ogni mezzo. / Every part of this catalogue - photos included - is Euro-Fer's property. All forms of copying are strictly prohibited.





Martellato / Hammered

H.1200 mm.  
Art. 06.032.11 □ 12  
Art. 06.032.12 □ 14  
Art. 06.032.13 □ 16



Martellato / Hammered

H.250 mm.  
Art. 06.033 □ 12  
Art. 06.034 □ 14  
Art. 06.035 □ 16



Tondo / Round

H.250 mm.  
Art. 06.035.01 Ø 12  
Art. 06.035.02 Ø 14  
Art. 06.035.03 Ø 16



H.250 mm.  
Art. 06.035.04 □ 12  
Art. 06.035.05 □ 14  
Art. 06.035.06 □ 16



Battuto 4 lati / Beaten on 4 sides

H.250 mm.  
Art. 06.035.07 □ 12  
Art. 06.035.08 □ 14  
Art. 06.035.09 □ 16



Martellato / Hammered

H.250 mm.  
Art. 06.035.10 □ 12  
Art. 06.035.11 □ 14  
Art. 06.035.12 □ 16



Mart. / Hammered

H.950 X L.100 mm.  
Art. 06.036  
≠ 25 X 12



Mart. / Hammered

H.950 X L.100 mm.  
Art. 06.037  
≠ 25 X 12



Mattone / Brick

H.950 X L.100 mm.  
Art. 06.038  
≠ 40 X 4



NEW  
DESIGN



Mattone / Brick

H.950 X L.100 mm.  
Art. 06.039  
≠ 40 X 4



Martellato / Hammered

H.950 X L.230 mm.  
Art. 06.040  
□ 12 ≠ 12 X 6  
Art. 06.040.01  
□ 14 ≠ 14 X 6



Martellato / Hammered

H.950 X L.160 mm.  
Art. 06.041  
□ 12 ≠ 12 X 6  
Art. 06.041.01  
□ 14 ≠ 14 X 6



Martellato / Hammered

H.950 X L.160 mm.  
Art. 06.042  
□ 12 ≠ 12 X 6  
Art. 06.042.01  
□ 14 ≠ 14 X 6



Martellato / Hammered

H.950 X L.115 mm.  
Art. 06.043  
□ 12 ≠ 12 X 6  
Art. 06.043.01  
□ 14 ≠ 14 X 6

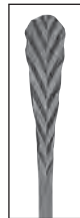

Liscio / Smooth

H.950 mm.  
Art. 06.044 □ 12  
Art. 06.045 □ 14



Martellato / Hammered

H.950 mm.  
Art. 06.046 □ 12  
Art. 06.047 □ 14



Martellato / Hammered

H.950 mm.  
Art. 06.048 □ 12  
Art. 06.049 □ 14

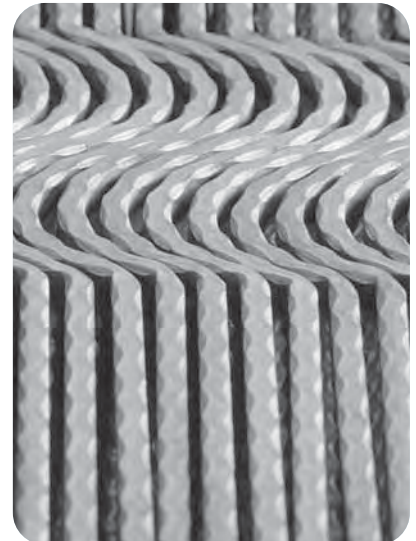



Martellato / Hammered  
H.950 X L.170 mm.  
Art. 06.050  12  
Art. 06.050.01  14



Martellato / Hammered  
H.950 X L.155 mm.  
Art. 06.051  12  
Art. 06.051.01  14



Martellato / Hammered  
H.950 X L.155 mm.  
Art. 06.052  12  
Art. 06.052.01  14



Martellato / Hammered  
H.950 X L.200 mm.  
Art. 06.053  12  
Art. 06.054  14



Martellato / Hammered  
H.950 X L.125 mm.  
Art. 06.055  12  
Art. 06.056  14



Tondo / Round  
H.950 mm.  
Art. 06.057  $\varnothing$  12  
Art. 06.058  $\varnothing$  14



Martellato / Hammered  
H.1100 mm.  
Art. 06.059  20  
Art. 06.060  25

Vedi Art. / See Article 11.053.20 / 11.053.21



Martellato / Hammered  
H.1000 X L.150 mm.  
Art. 06.061  12  
Art. 06.062  14



Martellato / Hammered  
H.1000 X L.150 mm.  
Art. 06.063  12  
Art. 06.064  14



H.950 X L.105 mm.  
Art. 06.065  12  
Art. 06.066  14



H.950 X L.105 mm.  
Art. 06.067  12  
Art. 06.068  14



Martellato / Hammered  
H.950 X L.105 mm.  
Art. 06.069  12  
Art. 06.070  14



Martellato / Hammered  
H.950 X L.105 mm.  
Art. 06.071  12  
Art. 06.072  14



Martellato / Hammered  
H.950 X L.105 mm.  
Art. 06.073  12  
Art. 06.074  14



Martellato / Hammered  
H.950 X L.160 mm.  
Art. 06.075  12  
Art. 06.076  14

160



Martellato / Hammered  
H.950 mm.  
Art. 06.077  14



Martellato / Hammered  
H.950 X L.100 mm.  
Art. 06.078 □ 12



Martellato / Hammered  
H.950 X L.100 mm.  
Art. 06.079 □ 12



Martellato / Hammered  
H.950 X L.180 mm.  
Art. 06.080 □ 12



Martellato / Hammered  
H.950 X L.260 mm.  
Art. 06.081 □ 14



Martellato / Hammered  
H.950 X L.260 mm.  
Art. 06.082 □ 14



Martellato / Hammered  
H. 1000 X L. 115 mm.  
Art. 06.083  
□ 12  
≠ 12 x 6  
Mod. Scala / Scala Model





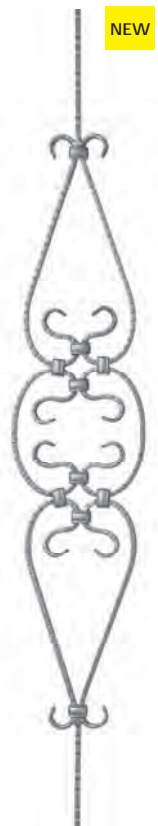



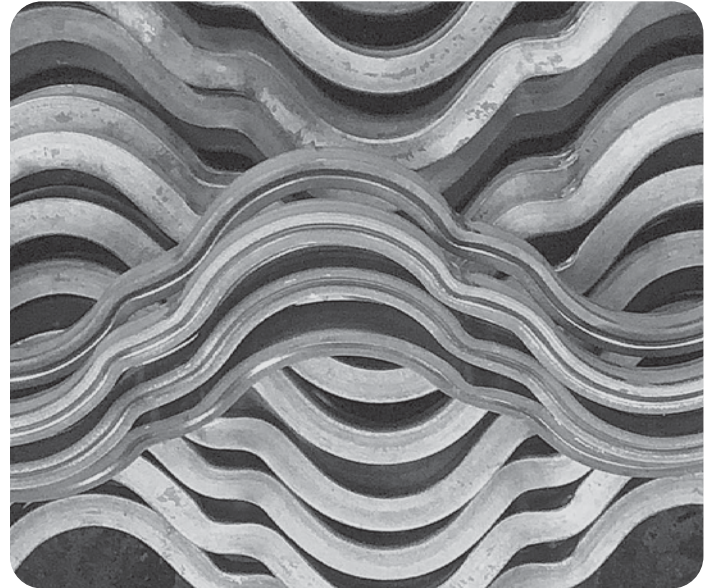
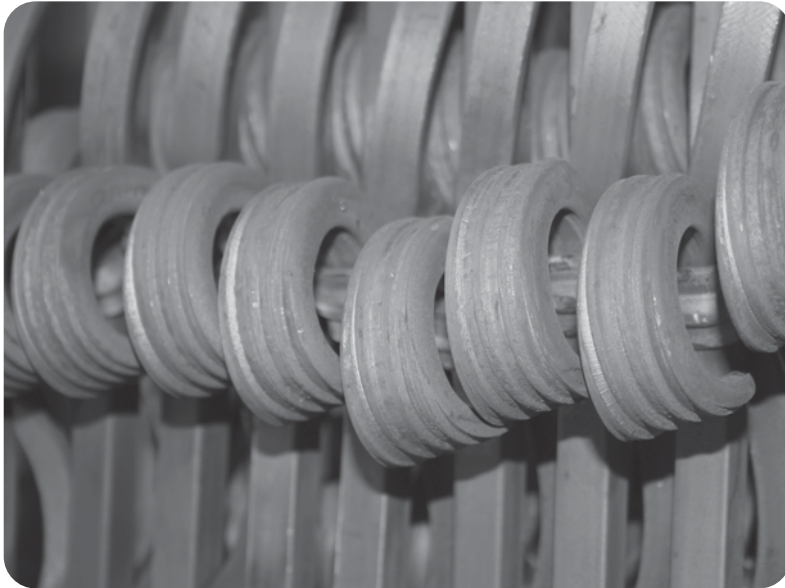

Martellato / Hammered  
H. 1000 X L. 115 mm.  
Art. 06.084  
□ 12  
≠ 12 x 6  
Mod. Scala / Scala Model



Mod. Scala / Scala Model  
H. 950 X L. 145 mm.  
Art. 06.085  
≠ 16 x 6





 Modello Liquirizia / Liquorice Model H.950 mm. Art. 07.001 <input type="checkbox"/> 12 Art. 07.001.01 <input type="checkbox"/> 14 Art. 07.001.05 <input type="checkbox"/> 16	 Modello Liquirizia / Liquorice Model H.950 mm. Art. 07.001.02 <input type="checkbox"/> 12 Art. 07.001.03 <input type="checkbox"/> 14 Art. 07.001.06 <input type="checkbox"/> 16	 Modello Liquirizia / Liquorice Model H.950 mm Art. 07.001.07 <input type="checkbox"/> 12 Art. 07.001.08 <input type="checkbox"/> 14	 Modello Liquirizia / Liquorice Model H.950 mm Art. 07.001.09 <input type="checkbox"/> 12 Art. 07.001.10 <input type="checkbox"/> 14	 Modello Liquirizia / Liquorice Model H.950 mm Art. 07.001.11 <input type="checkbox"/> 12 Art. 07.001.12 <input type="checkbox"/> 14 Art. 07.001.13 <input type="checkbox"/> 16	 H.950 mm. Art. 07.002 <input type="checkbox"/> 12 Art. 07.002.01 <input type="checkbox"/> 14 Art. 07.002.03 <input type="checkbox"/> 16	 H.950 mm. Art. 07.003 <input type="checkbox"/> 12 Art. 07.003.01 <input type="checkbox"/> 14 Art. 07.003.06 <input type="checkbox"/> 16
--	---	--	--	--	--	--

 H.950 mm. Art. 07.002.02 <input type="checkbox"/> 12 Art. 07.002.01 <input type="checkbox"/> 14 Art. 07.002.03 <input type="checkbox"/> 16	 H.950 mm. Art. 07.003.02 <input type="checkbox"/> 12 Art. 07.003.01 <input type="checkbox"/> 14 Art. 07.003.06 <input type="checkbox"/> 16	 H.950 mm. Art. 07.003.05 <input type="checkbox"/> 12 Art. 07.003.04 <input type="checkbox"/> 14 Art. 07.003.06 <input type="checkbox"/> 16	 H.950 X L.140 mm. Art. 07.004 <input type="checkbox"/> 12 <input type="checkbox"/> 12 X 6	 H.950 X L.140 mm. Art. 07.005 <input type="checkbox"/> 12 <input type="checkbox"/> 12 X 6	 H.950 X L.100 Art. 07.006 <input type="checkbox"/> 12
---	--	--	---	---	---

Tutte le parti di questo catalogo - foto comprese - sono di proprietà Euro-Fer. La riproduzione, anche parziale, è vietata in ogni forma e con ogni mezzo. / Every part of this catalogue - photos included - is Euro-Fer's property. All forms of copying are strictly prohibited.



H.950 X L.105 mm.  
Art. 07.007 □ 12



H.950 X L.115 mm.  
Art. 07.007.01 □ 12



H.950 mm.  
Art. 07.008 □ 12



H.950 mm.  
Art. 07.009 □ 12



H.950 X L.165 mm.  
Art. 07.010  
□ 12 ≠ 12 X 6



H.950 X L.165 mm.  
Art. 07.011  
□ 12 ≠ 12 X 6



H.950 X L.145 mm.  
Art. 07.012  
□ 12 ≠ 12 X 6



H.950 X L.70 mm.  
Art. 07.013 □ 12



H.950 X L.190 mm.  
Art. 07.014  
□ 12 ≠ 12 X 6



H.950 X L.145 mm.  
Art. 07.015  
□ 12 ≠ 12 X 6



H.950 X L.215 mm.  
Art. 07.016  
□ 12 ≠ 12 X 6



H.950 X L.170 mm.  
Art. 07.017  
□ 12 ≠ 12 X 6



H.950 X L.140 mm.  
Art. 07.018  
□ 12 ≠ 12 X 6



H.950 X L.230 mm.  
Art. 07.019  
□ 12 ≠ 12 X 6  
Art. 07.019.01  
□ 14 ≠ 14 X 6



Liscio / Smooth  
H.950 x L.230 mm  
Art. 07.019.02 □ 12  
Art. 07.019.03 □ 14



H.950 X L.205 mm.  
Art. 07.020  
□ 12 ≠ 12 X 6  
Art. 07.020.01  
□ 14 ≠ 14 X 6



H.950 X L.145 mm.  
Art. 07.021  
□ 12 ≠ 12 X 6



H.850 X L.200 mm.  
Art. 07.022  
□ 12 ≠ 12 X 6



H.850 X L.200 mm.  
Art. 07.023  
□ 12 ≠ 12 X 6

Tutte le parti di questo catalogo - foto comprese - sono di proprietà Euro-Fer. La riproduzione, anche parziale, è vietata in ogni forma e con ogni mezzo. / Every part of this catalogue - photos included - is Euro-Fer's property. All forms of copying are strictly prohibited.

PANNELLI RIGATI CON PROFILO A NUVOLA  
FLUTED PANELS "CLOUD"

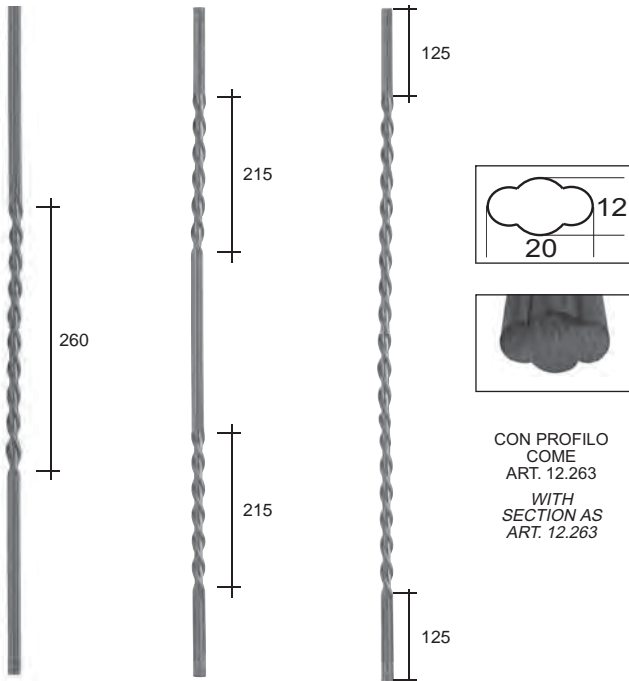

CON PROFILO  
COME  
ART. 12.263  
WITH  
SECTION AS  
ART. 12.263

Rigato / Fluted  
H.950 mm.  
Art. 07.050  
20 x 12

Rigato / Fluted  
H.950 mm.  
Art. 07.051  
20 x 12

Rigato / Fluted  
H.950 mm.  
Art. 07.052  
20 x 12



Rigato / Fluted  
H.950 x L.100 mm  
Art. 05.591 □ 14  
Art. 05.591.01 □ 12  
Con fiori su ambo i lati /  
Flowers on both sides



H.900 mm  
Art. 07.060 2 x Ø 8



H.900 mm  
Art. 07.061 2 x Ø 8



H.900 x L.120 mm  
Art. 07.064 2 x Ø 8



NEW

Rigato / Fluted  
H. 950 X L. 120 mm.  
Art. 07.066  
□ 12  
≠ 12 x 6



NEW

Rigato / Fluted  
H. 950 X L. 120 mm.  
Art. 07.067  
□ 12  
≠ 12 x 6





Tubo Liscio /  
*Smooth Tube*  
H.900 mm  
Art. TB.21.900 Ø 30



Tubo Liscio /  
*Smooth Tube*  
H.900 mm  
Art. TB.21.901 Ø 30



Tubo Liscio /  
*Smooth Tube*  
H.900 mm  
Art. TB.21.902 Ø 30



Tubo Liscio /  
*Smooth Tube*  
H.900 mm  
Art. TB.21.903 Ø 30



Tubo Liscio /  
*Smooth Tube*  
H.1200 mm  
Art. TB.24.400 Ø 40

Tutte le parti di questo catalogo - foto comprese - sono di proprietà Euro-Fer. La riproduzione, anche parziale, è vietata in ogni forma e con ogni mezzo. / Every part of this catalogue - photos included - is Euro-Fer's property. All forms of copying are strictly prohibited.



sezione ferro iron section	tipo ferro iron type	codice code	interasse centre distance	nr. fori nr. of holes	tipo fori kind of holes	luce hole to hole	trattamento finishing
■ 12x12	liscio / smooth	<b>08.006.01</b>	120 mm	16 fori / holes	□ 12x12	108 mm	grezzo / raw
■ 14x14	liscio / smooth	<b>08.119</b>	125 mm	15 fori / holes	□ 14x14	111 mm	grezzo / raw
■ 14x14	liscio / smooth <span style="color: orange;">ES</span>	<b>08.119.01</b>	125 mm	14 fori / holes	□ 14x14	111 mm.	grezzo / raw
■ 14x14	liscio / smooth	<b>08.001</b>	140 mm	14 fori / holes	□ 14x14	126 mm	grezzo / raw
■ 16x16	liscio / smooth	<b>08.120</b>	125 mm	15 fori / holes	□ 16x16	109 mm	grezzo / raw
■ 16x16	liscio / smooth	<b>08.131</b>	125 mm	15 fori / holes	□ 14x14	111 mm	grezzo / raw
■ 16x16	liscio / smooth <span style="color: orange;">ES</span>	<b>08.120.01</b>	135 mm	14 fori / holes	□ 16x16	119 mm	grezzo / raw
■ 16x16	liscio / smooth	<b>08.002</b>	150 mm	13 fori / holes	□ 16x16	134 mm	grezzo / raw
■ 18x18	liscio / smooth	<b>08.121</b>	128 mm	14 fori / holes	□ 18x18	110 mm	grezzo / raw
■ 18x18	liscio / smooth	<b>08.003</b>	160 mm	12 fori / holes	□ 18x18	142 mm	grezzo / raw
■ 20x20	liscio / smooth	<b>08.122</b>	130 mm	13 fori / holes	□ 20x20	110 mm	grezzo / raw
■ 20x20	liscio / smooth	<b>08.004</b>	170 mm	11 fori / holes	□ 20x20	150 mm	grezzo / raw
■ 22x22	liscio / smooth	<b>08.005</b>	170 mm	11 fori / holes	□ 22x22	148 mm	grezzo / raw
■ 25x25	liscio / smooth	<b>08.006</b>	180 mm	10 fori / holes	□ 25x25	155 mm	grezzo / raw

lunghezza standard 2000 mm.  
standard size 2000 mm.

- quadro / square
- ◇ foro quadro in obliquo / slanting square hole
- ∅ tondo / round
- ∅ foro ovale / oval hole
- foro rettangolo / rectangular hole
- ES foro largo / larger hole

Riassunto barre forate in ordine di codice a pag. 261  
Summary holed bars in order of code on pag. 261

Tutte le parti di questo catalogo - foto comprese - sono di proprietà Euro-Fer. La riproduzione, anche parziale, è vietata in ogni forma e con ogni mezzo. / Every part of this catalogue - photos included - is Euro-Fer's property. All forms of copying are strictly prohibited.



sezione ferro <i>iron section</i>	tipo ferro <i>iron type</i>	codice <i>code</i>	interasse <i>centre distance</i>	nr. fori <i>nr. of holes</i>	tipo fori <i>kind of holes</i>	luce <i>hole to hole</i>	trattamento <i>finishing</i>
■ 14x14	liscio / smooth	<b>08.123</b>	128 mm	14 fori / holes	◇14x14 sullo spigolo / on the edge	108 mm	grezzo / raw
■ 14x14	liscio / smooth	<b>08.007</b>	140 mm	14 fori / holes	◇14x14 sullo spigolo / on the edge	120 mm	grezzo / raw
■ 16x16	liscio / smooth	<b>08.124</b>	130 mm	14 fori / holes	◇16x16 sullo spigolo / on the edge	107 mm	grezzo / raw
■ 16x16	liscio / smooth	<b>08.008</b>	150 mm	13 fori / holes	◇16x16 sullo spigolo / on the edge	127 mm	grezzo / raw
■ 18x18	liscio / smooth	<b>08.125</b>	132 mm	14 fori / holes	◇18x18 sullo spigolo / on the edge	107 mm	grezzo / raw
■ 18x18	liscio / smooth	<b>08.009</b>	160 mm	12 fori / holes	◇18x18 sullo spigolo / on the edge	135 mm	grezzo / raw
■ 20x20	liscio / smooth	<b>08.126</b>	134 mm	13 fori / holes	◇20x20 sullo spigolo / on the edge	106 mm	grezzo / raw
■ 20x20	liscio / smooth	<b>08.010</b>	170 mm	11 fori / holes	◇20x20 sullo spigolo / on the edge	142 mm	grezzo / raw
■ 22x22	liscio / smooth	<b>08.011</b>	170 mm	11 fori / holes	◇22x22 sullo spigolo / on the edge	139 mm	grezzo / raw
■ 25x25	liscio / smooth	<b>08.012</b>	180 mm	10 fori / holes	◇25x25 sullo spigolo / on the edge	145 mm	grezzo / raw



■ 14x14	liscio / smooth	<b>08.127</b>	128 mm	14 fori / holes	◇14x14	108 mm	grezzo / raw
■ 14x14	liscio / smooth	<b>ES 08.127.01</b>	135 mm	14 fori / holes	◇14x14	115 mm	grezzo / raw
■ 14x14	liscio / smooth	<b>08.013</b>	140 mm	14 fori / holes	◇14x14	120 mm	grezzo / raw
■ 16x16	liscio / smooth	<b>ES 08.128.02</b>	125 mm	15 fori / holes	◇16x16	102 mm	grezzo / raw
■ 16x16	liscio / smooth	<b>08.128</b>	130 mm	14 fori / holes	◇16x16	107 mm	grezzo / raw
■ 16x16	liscio / smooth	<b>ES 08.128.01</b>	135 mm	14 fori / holes	◇16x16	112 mm	grezzo / raw
■ 16x16	liscio / smooth	<b>08.014</b>	150 mm	13 fori / holes	◇16x16	127 mm	grezzo / raw
■ 18x18	liscio / smooth	<b>08.129</b>	132 mm	14 fori / holes	◇18x18	107 mm	grezzo / raw
■ 18x18	liscio / smooth	<b>ES 08.129.01</b>	135 mm	14 fori / holes	◇18x18	110 mm	grezzo / raw
■ 18x18	liscio / smooth	<b>08.015</b>	160 mm	12 fori / holes	◇18x18	135 mm	grezzo / raw
■ 20x20	liscio / smooth	<b>08.130</b>	135 mm	13 fori / holes	◇20x20	107 mm	grezzo / raw
■ 20x20	liscio / smooth	<b>08.016</b>	170 mm	11 fori / holes	◇20x20	142 mm	grezzo / raw
■ 22x22	liscio / smooth	<b>08.017</b>	170 mm	11 fori / holes	◇22x22	139 mm	grezzo / raw
■ 25x25	liscio / smooth	<b>08.018</b>	180 mm	10 fori / holes	◇25x25	145 mm	grezzo / raw



Ø 14	liscio / smooth	<b>08.019</b>	140 mm	14 fori / holes	θ 14x26 mm ovale / oval		grezzo / raw
Ø 16	liscio / smooth	<b>08.020</b>	150 mm	13 fori / holes	θ 16x28 mm ovale / oval		grezzo / raw
Ø 18	liscio / smooth	<b>08.021</b>	160 mm	12 fori / holes	θ 18x30 mm ovale / oval		grezzo / raw
Ø 20	liscio / smooth	<b>08.022</b>	170 mm	11 fori / holes	θ 20x33 mm ovale / oval		grezzo / raw

lunghezza standard 2000 mm.  
standard size 2000 mm.

□	quadro / square
◇	foro quadro in obliquo / slanting square hole
Ø	tondo / round
θ	foro ovale / oval hole
▭	foro rettangolo / rectangular hole
<b>ES</b>	foro largo / larger hole

Riassunto barre forate in ordine di codice a pag. 261  
Summary holed bars in order of code on pag. 261





sezione ferro <i>iron section</i>	tipo ferro <i>iron type</i>	codice <i>code</i>	interasse <i>centre distance</i>	nr. fori <i>nr. of holes</i>	tipo fori <i>kind of holes</i>	luce <i>hole to hole</i>	trattamento <i>finishing</i>
Ø 12	liscio / smooth	<b>08.029.01</b>	120 mm	16 fori / holes	Ø 12	108 mm	grezzo / raw
Ø 14	liscio / smooth	<b>08.115</b>	125 mm	15 fori / holes	Ø 14	111 mm	grezzo / raw
Ø 14	liscio / smooth	<b>08.115.01</b>	130 mm	14 fori / holes	Ø 14	116 mm	grezzo / raw
Ø 14	liscio / smooth	<b>08.023</b>	140 mm	14 fori / holes	Ø 14	126 mm	grezzo / raw
Ø 16	liscio / smooth	<b>08.116</b>	125 mm	15 fori / holes	Ø 16	109 mm	grezzo / raw
Ø 16	liscio / smooth	<b>08.132</b>	125 mm	15 fori / holes	Ø 14	111 mm	grezzo / raw
Ø 16	liscio / smooth	<b>08.024</b>	150 mm	13 fori / holes	Ø 16	126 mm	grezzo / raw
Ø 16	liscio / smooth	<b>08.116.01</b>	160 mm	12 fori / holes	Ø 16	144 mm	grezzo / raw
Ø 18	liscio / smooth	<b>08.117</b>	128 mm	14 fori / holes	Ø 18	110 mm	grezzo / raw
Ø 18	liscio / smooth	<b>08.025</b>	160 mm	12 fori / holes	Ø 18	142 mm	grezzo / raw
Ø 20	liscio / smooth	<b>08.118</b>	130 mm	13 fori / holes	Ø 20	110 mm	grezzo / raw
Ø 20	liscio / smooth	<b>08.026</b>	170 mm	11 fori / holes	Ø 20	150 mm	grezzo / raw
Ø 22	liscio / smooth	<b>08.027</b>	170 mm	11 fori / holes	Ø 22	148 mm	grezzo / raw
Ø 25	liscio / smooth	<b>08.028</b>	180 mm	10 fori / holes	Ø 25	155 mm	grezzo / raw
Ø 30	liscio / smooth	<b>08.029</b>	200 mm	9 fori / holes	Ø 30	170 mm	grezzo / raw



■ 14x14	liscio / smooth	<b>08.106</b>	140 mm	14 fori / holes	□ 24x15 rettangolo / rectangular		grezzo / raw
■ 16x16	liscio / smooth	<b>08.107</b>	150 mm	13 fori / holes	□ 30x17 rettangolo / rectangular		grezzo / raw
■ 18x18	liscio / smooth	<b>08.108</b>	160 mm	12 fori / holes	□ 31x19 rettangolo / rectangular		grezzo / raw
■ 20x20	liscio / smooth	<b>08.109</b>	170 mm	11 fori / holes	□ 33x21 rettangolo / rectangular		grezzo / raw



Ø 14	corteccia / bark	<b>08.130.01</b>	125 mm	15 fori / holes	Ø 14	111 mm	grezzo / raw
Ø 14	corteccia / bark	<b>08.109.01</b>	140 mm	14 fori / holes	Ø 14	126 mm	grezzo / raw
Ø 16	corteccia / bark	<b>08.130.02</b>	125 mm	15 fori / holes	Ø 16	109 mm	grezzo / raw
Ø 16	corteccia / bark	<b>08.109.02</b>	150 mm	13 fori / holes	Ø 16	126 mm	grezzo / raw
Ø 18	corteccia / bark	<b>08.130.03</b>	128 mm	14 fori / holes	Ø 18	110 mm	grezzo / raw
Ø 18	corteccia / bark	<b>08.109.03</b>	160 mm	12 fori / holes	Ø 18	142 mm	grezzo / raw
Ø 20	corteccia / bark	<b>08.109.04</b>	170 mm	11 fori / holes	Ø 20	150 mm	grezzo / raw
Ø 22	corteccia / bark	<b>08.109.05</b>	170 mm	11 fori / holes	Ø 22	148 mm	grezzo / raw

lunghezza standard 2000 mm.  
standard size 2000 mm.

- quadro / square
- ◇ foro quadro in obliquo / *slanting square hole*
- Ø tondo / round
- ∅ foro ovale / *oval hole*
- foro rettangolo / *rectangular hole*
- ES foro largo / *larger hole*

Riassunto barre forate in ordine di codice a pag. 261  
Summary holed bars in order of code on pag. 261



sezione ferro <i>iron section</i>	tipo ferro <i>iron type</i>	codice <i>code</i>	interasse centre distance	nr. fori <i>nr. of holes</i>	tipo fori <i>kind of holes</i>	luce <i>hole to hole</i>	trattamento <i>finishing</i>
■ 12x12	martellato / hammered	<b>08.110</b>	120 mm	16 fori / holes	□ 12x12	108 mm	grezzo / raw
■ 14x14	martellato / hammered	<b>08.111</b>	140 mm	14 fori / holes	□ 14x14	126 mm	grezzo / raw
■ 16x16	martellato / hammered	<b>08.112</b>	150 mm	13 fori / holes	□ 16x16	134 mm	grezzo / raw
■ 18x18	martellato / hammered	<b>08.113</b>	160 mm	12 fori / holes	□ 18x18	142 mm	grezzo / raw
■ 20x20	martellato / hammered	<b>08.114</b>	170 mm	11 fori / holes	□ 20x20	150 mm	grezzo / raw



■ 14x14	corteccia / bark	<b>08.114.01</b>	140 mm	14 fori / holes	□ 14x14	126 mm	grezzo / raw
■ 16x16	corteccia / bark	<b>08.114.02</b>	150 mm	13 fori / holes	□ 16x16	134 mm	grezzo / raw



■ 14x14	corteccia / bark	<b>08.114.10</b>	140 mm	14 fori / holes	◇ 14x14	120 mm	grezzo / raw
■ 16x16	corteccia / bark	<b>08.114.11</b>	150 mm	13 fori / holes	◇ 16x16	127 mm	grezzo / raw



■ 14x14	martellato / hammered	<b>08.114.20</b>	140 mm	14 fori / holes	◇ 14x14 sullo spigolo / on the edge	120 mm	grezzo / raw
■ 16x16	martellato / hammered	<b>08.114.21</b>	150 mm	13 fori / holes	◇ 16x16 sullo spigolo / on the edge	127 mm	grezzo / raw



■ 12x12	in spigolo / edged	<b>08.114.30</b>	120 mm	16 fori / holes	□ 12x12	108 mm	grezzo / raw
■ 14x14	in spigolo / edged	<b>08.114.31</b>	140 mm	14 fori / holes	□ 14x14	126 mm	grezzo / raw
■ 16x16	in spigolo / edged	<b>08.114.32</b>	150 mm	13 fori / holes	□ 16x16	134 mm	grezzo / raw
■ 18x18	in spigolo / edged	<b>08.114.33</b>	160 mm	12 fori / holes	□ 18x18	142 mm	grezzo / raw

lunghezza standard 2000 mm.  
standard size 2000 mm.

□	quadro / square
◇	foro quadro in obliquo / slanting square hole
∅	tondo / round
∅	foro ovale / oval hole
□	foro rettangolo / rectangular hole
ES	foro largo / larger hole

Riassunto barre forate in ordine di codice a pag. 261  
Summary holed bars in order of code on pag. 261

## BARRE FORATE SABBiate SANDBLASTED HOLED BARS



BARRE FORATE SABBiate / SANDBLASTED HOLED BARS

sezione ferro iron section	tipo ferro iron type	codice code	interasse centre distance	nr. fori nr. of holes	tipo fori kind of holes	luce hole to hole	trattamento finishing
■ 12x12	liscio / smooth	<b>08.133</b>	120 mm	16 fori / holes	□ 12x12	108 mm	sabbiato / sandblasted
■ 14x14	liscio / smooth	<b>08.168</b>	125 mm	15 fori / holes	□ 14x14	111 mm	sabbiato / sandblasted
■ 14x14	liscio / smooth <span style="color: orange;">ES</span>	<b>08.168.01</b>	125 mm	14 fori / holes	□ 14x14	111 mm.	sabbiato / sandblasted
■ 14x14	liscio / smooth	<b>08.134</b>	140 mm	14 fori / holes	□ 14x14	126 mm	sabbiato / sandblasted
■ 16x16	liscio / smooth	<b>08.169</b>	125 mm	15 fori / holes	□ 16x16	109 mm	sabbiato / sandblasted
■ 16x16	liscio / smooth	<b>08.180</b>	125 mm	15 fori / holes	□ 14x14	111 mm	sabbiato / sandblasted
■ 16x16	liscio / smooth <span style="color: orange;">ES</span>	<b>08.169.01</b>	135 mm	14 fori / holes	□ 16x16	119 mm	sabbiato / sandblasted
■ 16x16	liscio / smooth	<b>08.135</b>	150 mm	13 fori / holes	□ 16x16	134 mm	sabbiato / sandblasted
■ 18x18	liscio / smooth	<b>08.170</b>	128 mm	14 fori / holes	□ 18x18	110 mm	sabbiato / sandblasted
■ 18x18	liscio / smooth	<b>08.136</b>	160 mm	12 fori / holes	□ 18x18	142 mm	sabbiato / sandblasted
■ 20x20	liscio / smooth	<b>08.171</b>	130 mm	13 fori / holes	□ 20x20	110 mm	sabbiato / sandblasted
■ 20x20	liscio / smooth	<b>08.137</b>	170 mm	11 fori / holes	□ 20x20	150 mm	sabbiato / sandblasted
■ 22x22	liscio / smooth	<b>08.138</b>	170 mm	11 fori / holes	□ 22x22	148 mm	sabbiato / sandblasted
■ 25x25	liscio / smooth	<b>08.139</b>	180 mm	10 fori / holes	□ 25x25	155 mm	sabbiato / sandblasted



BARRE FORATE SABBiate / SANDBLASTED HOLED BARS

■ 14x14	liscio / smooth	<b>08.172</b>	128 mm	14 fori / holes	◇ 14x14 sullo spigolo / on the edge	108 mm	sabbiato / sandblasted
■ 14x14	liscio / smooth	<b>08.140</b>	140 mm	14 fori / holes	◇ 14x14 sullo spigolo / on the edge	120 mm	sabbiato / sandblasted
■ 16x16	liscio / smooth	<b>08.173</b>	130 mm	14 fori / holes	◇ 16x16 sullo spigolo / on the edge	107 mm	sabbiato / sandblasted
■ 16x16	liscio / smooth	<b>08.141</b>	150 mm	13 fori / holes	◇ 16x16 sullo spigolo / on the edge	127 mm	sabbiato / sandblasted
■ 18x18	liscio / smooth	<b>08.174</b>	132 mm	14 fori / holes	◇ 18x18 sullo spigolo / on the edge	107 mm	sabbiato / sandblasted
■ 18x18	liscio / smooth	<b>08.142</b>	160 mm	12 fori / holes	◇ 18x18 sullo spigolo / on the edge	135 mm	sabbiato / sandblasted
■ 20x20	liscio / smooth	<b>08.175</b>	134 mm	13 fori / holes	◇ 20x20 sullo spigolo / on the edge	106 mm	sabbiato / sandblasted
■ 20x20	liscio / smooth	<b>08.143</b>	170 mm	11 fori / holes	◇ 20x20 sullo spigolo / on the edge	142 mm	sabbiato / sandblasted
■ 22x22	liscio / smooth	<b>08.144</b>	170 mm	11 fori / holes	◇ 22x22 sullo spigolo / on the edge	139 mm	sabbiato / sandblasted
■ 25x25	liscio / smooth	<b>08.145</b>	180 mm	10 fori / holes	◇ 25x25 sullo spigolo / on the edge	145 mm	sabbiato / sandblasted

lunghezza standard 2000 mm.  
standard size 2000 mm.

- quadro / square
- ◇ foro quadro in obliquo / slanting square hole
- ∅ tondo / round
- ∅ foro ovale / oval hole
- foro rettangolo / rectangular hole
- ES foro largo / larger hole

Riassunto barre forate in ordine di codice a pag. 261  
Summary holed bars in order of code on pag. 261





BARRE FORATE SABBIASTE / SANDBLASTED HOLED BARS

sezione ferro iron section	tipo ferro iron type	codice code	interasse centre distance	nr. fori nr. of holes	tipo fori kind of holes	luce hole to hole	trattamento finishing
■ 14x14	liscio / smooth	<b>08.176</b>	128 mm	14 fori / holes	◇14x14	108 mm	sabbiato / sandblasted
■ 14x14	liscio / smooth <span style="color: orange;">ES</span>	<b>08.176.01</b>	135 mm	14 fori / holes	◇14x14	115 mm	sabbiato / sandblasted
■ 14x14	liscio / smooth	<b>08.146</b>	140 mm	14 fori / holes	◇14x14	120 mm	sabbiato / sandblasted
■ 16x16	liscio / smooth <span style="color: orange;">ES</span>	<b>08.177.02</b>	125 mm	15 fori / holes	◇16x16	102 mm	sabbiato / sandblasted
■ 16x16	liscio / smooth	<b>08.177</b>	130 mm	14 fori / holes	◇16x16	107 mm	sabbiato / sandblasted
■ 16x16	liscio / smooth <span style="color: orange;">ES</span>	<b>08.177.01</b>	135 mm	14 fori / holes	◇16x16	112 mm	sabbiato / sandblasted
■ 16x16	liscio / smooth	<b>08.147</b>	150 mm	13 fori / holes	◇16x16	127 mm	sabbiato / sandblasted
■ 18x18	liscio / smooth	<b>08.178</b>	132 mm	14 fori / holes	◇18x18	107 mm	sabbiato / sandblasted
■ 18x18	liscio / smooth <span style="color: orange;">ES</span>	<b>08.178.01</b>	135 mm	14 fori / holes	◇18x18	110 mm	sabbiato / sandblasted
■ 18x18	liscio / smooth	<b>08.148</b>	160 mm	12 fori / holes	◇18x18	135 mm	sabbiato / sandblasted
■ 20x20	liscio / smooth	<b>08.179</b>	135 mm	13 fori / holes	◇20x20	107 mm	sabbiato / sandblasted
■ 20x20	liscio / smooth	<b>08.149</b>	170 mm	11 fori / holes	◇20x20	142 mm	sabbiato / sandblasted
■ 22x22	liscio / smooth	<b>08.150</b>	170 mm	11 fori / holes	◇22x22	139 mm	sabbiato / sandblasted
■ 25x25	liscio / smooth	<b>08.151</b>	180 mm	10 fori / holes	◇25x25	145 mm	sabbiato / sandblasted



BARRE FORATE SABBIASTE / SANDBLASTED HOLED BARS

Ø 14	liscio / smooth	<b>08.152</b>	140 mm	14 fori / holes	∅ 14x26 mm ovale / oval		sabbiato / sandblasted
Ø 16	liscio / smooth	<b>08.153</b>	150 mm	13 fori / holes	∅ 16x28 mm ovale / oval		sabbiato / sandblasted
Ø 18	liscio / smooth	<b>08.154</b>	160 mm	12 fori / holes	∅ 18x30 mm ovale / oval		sabbiato / sandblasted
Ø 20	liscio / smooth	<b>08.155</b>	170 mm	11 fori / holes	∅ 20x33 mm ovale / oval		sabbiato / sandblasted



BARRE FORATE SABBIASTE / SANDBLASTED HOLED BARS

Ø 12	liscio / smooth	<b>08.156</b>	120 mm	16 fori / holes	Ø 12	108 mm	sabbiato / sandblasted
Ø 14	liscio / smooth	<b>08.164</b>	125 mm	15 fori / holes	Ø 14	111 mm	sabbiato / sandblasted
Ø 14	liscio / smooth	<b>08.164.01</b>	130 mm	14 fori / holes	Ø 14	116 mm	sabbiato / sandblasted
Ø 14	liscio / smooth	<b>08.157</b>	140 mm	14 fori / holes	Ø 14	126 mm	sabbiato / sandblasted
Ø 16	liscio / smooth	<b>08.165</b>	125 mm	15 fori / holes	Ø 16	109 mm	sabbiato / sandblasted
Ø 16	liscio / smooth	<b>08.181</b>	125 mm	15 fori / holes	Ø 14	111 mm	sabbiato / sandblasted
Ø 16	liscio / smooth	<b>08.158</b>	150 mm	13 fori / holes	Ø 16	126 mm	sabbiato / sandblasted
Ø 16	liscio / smooth	<b>08.165.01</b>	160 mm	12 fori / holes	Ø 16	144 mm	sabbiato / sandblasted
Ø 18	liscio / smooth	<b>08.166</b>	128 mm	14 fori / holes	Ø 18	110 mm	sabbiato / sandblasted
Ø 18	liscio / smooth	<b>08.159</b>	160 mm	12 fori / holes	Ø 18	142 mm	sabbiato / sandblasted
Ø 20	liscio / smooth	<b>08.167</b>	130 mm	13 fori / holes	Ø 20	110 mm	sabbiato / sandblasted
Ø 20	liscio / smooth	<b>08.160</b>	170 mm	11 fori / holes	Ø 20	150 mm	sabbiato / sandblasted
Ø 22	liscio / smooth	<b>08.161</b>	170 mm	11 fori / holes	Ø 22	148 mm	sabbiato / sandblasted
Ø 25	liscio / smooth	<b>08.162</b>	180 mm	10 fori / holes	Ø 25	155 mm	sabbiato / sandblasted
Ø 30	liscio / smooth	<b>08.163</b>	200 mm	9 fori / holes	Ø 30	170 mm	sabbiato / sandblasted

## BARRE FORATE HOLED BARS

Palline Grandi / Large Balls

INTERASSE / CENTRE DISTANCE 135 mm.

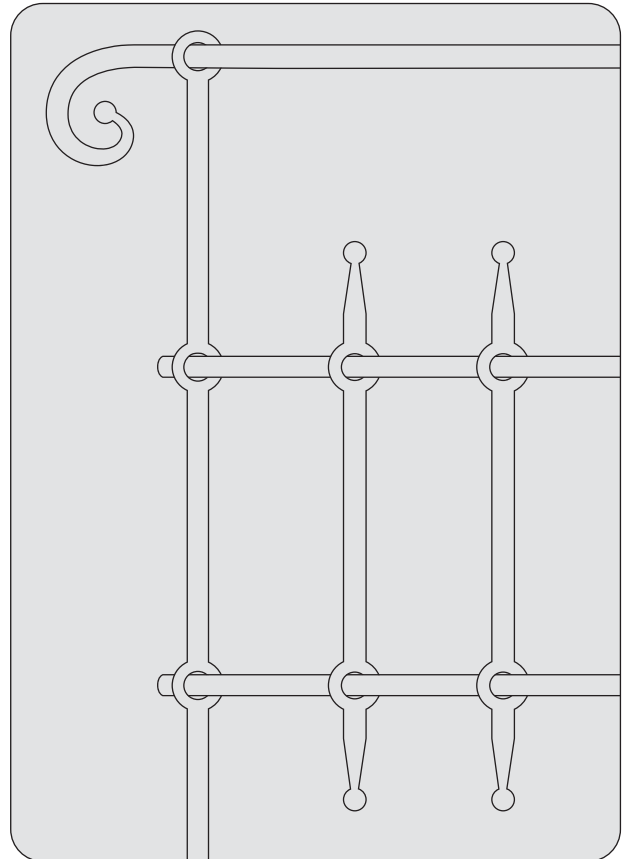
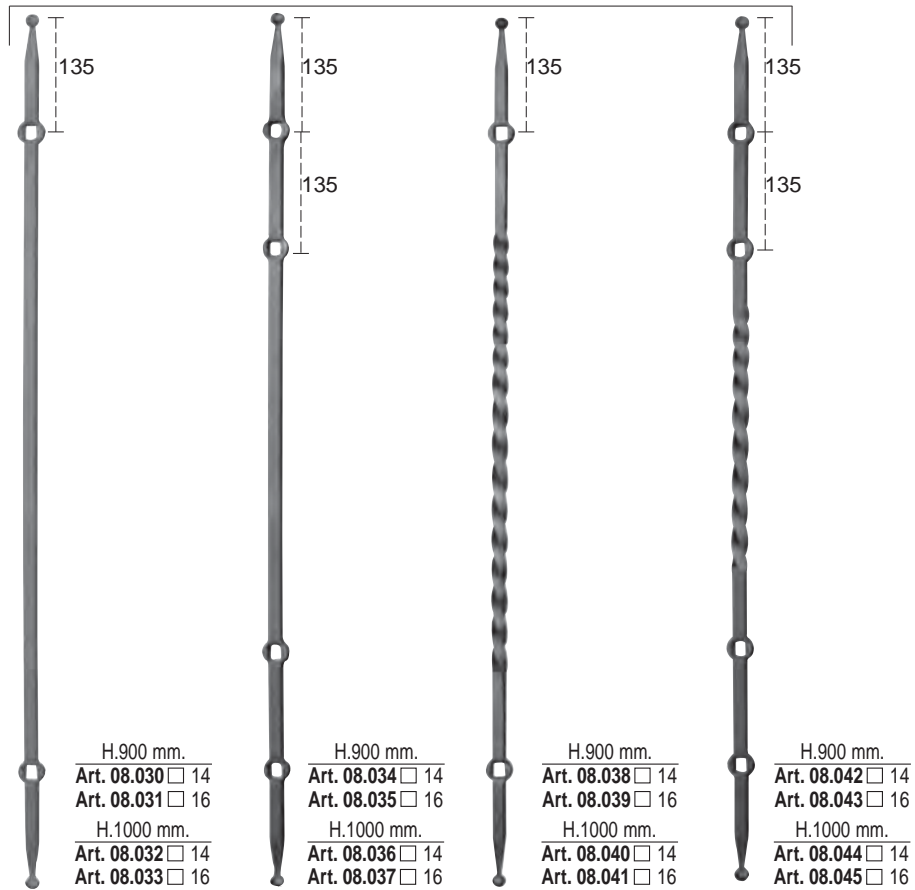

**ZF** ARTICOLI ZINCATI A FREDDO  
COLD GALVANIZED ARTICLES

Per le barre forate Zincate a Freddo andare a pag. 261 del Catalogo.  
See our Cold Galvanized holed bars at pag. 261 of the Catalogue.

Tutte le parti di questo catalogo - foto comprese - sono di proprietà Euro-Fer. La riproduzione, anche parziale, è vietata in ogni forma e con ogni mezzo. / Every part of this catalogue - photos included - is Euro-Fer's property. All forms of copying are strictly prohibited.

FORO TONDO / ROUND HOLE

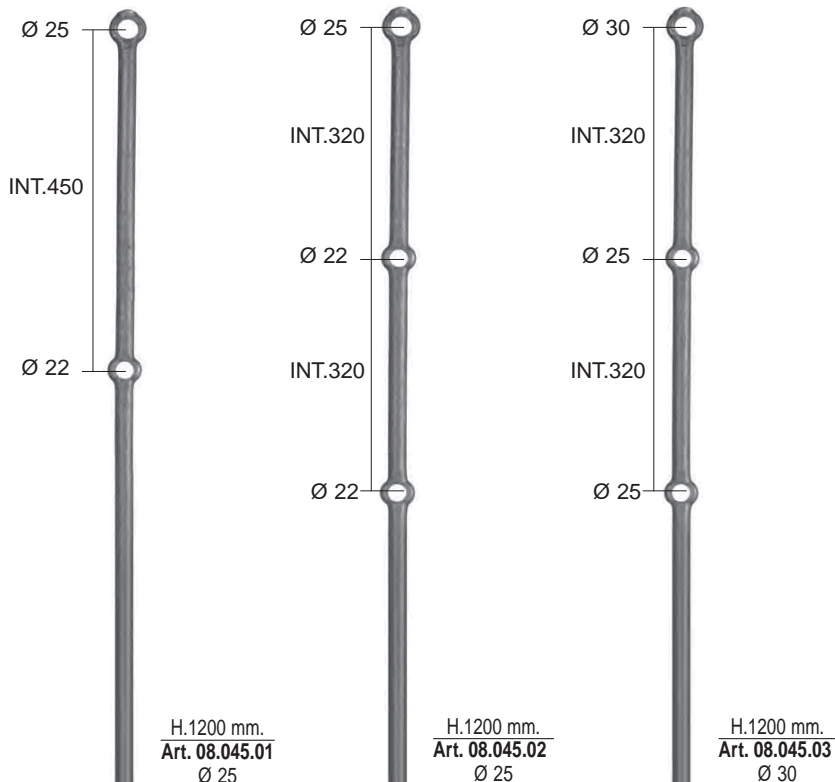

H.1200 mm.  
**Art. 08.045.01**  
 Ø 25

H.1200 mm.  
**Art. 08.045.02**  
 Ø 25

H.1200 mm.  
**Art. 08.045.03**  
 Ø 30

FORO OVALE / OVAL HOLE

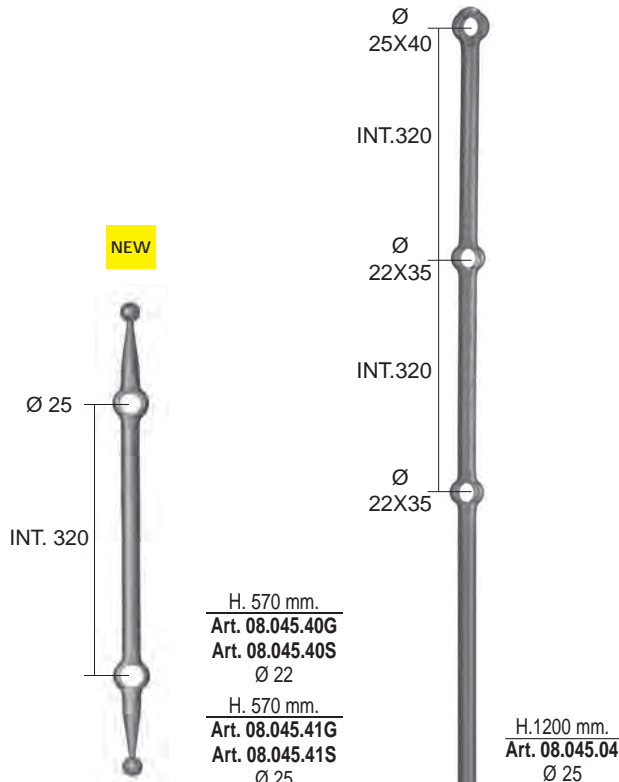

H. 570 mm.  
**Art. 08.045.40G**  
**Art. 08.045.40S**  
 Ø 22

H. 570 mm.  
**Art. 08.045.41G**  
**Art. 08.045.41S**  
 Ø 25

H.1200 mm.  
**Art. 08.045.04**  
 Ø 25

G: grezzo / raw  
 S: sabbiato / sandblasted

**NEW**

**NEW**

FORO OVALE  
 OVAL HOLE

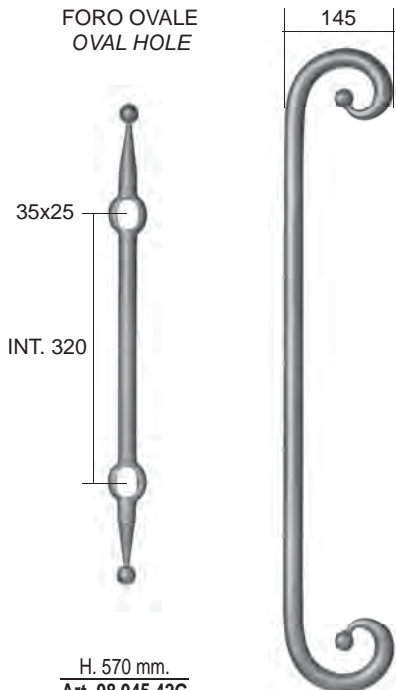

H. 570 mm.  
**Art. 08.045.42G**  
**Art. 08.045.42S**  
 Ø 22

H. 570 mm.  
**Art. 08.045.43G**  
**Art. 08.045.43S**  
 Ø 25

H. 740 X L. 120 mm.  
**Art. 08.045.45G**  
**Art. 08.045.45S**  
 Ø 20

H. 740 X L. 125 mm.  
**Art. 08.045.46G**  
**Art. 08.045.46S**  
 Ø 22

H. 740 X L. 130 mm.  
**Art. 08.045.47G**  
**Art. 08.045.47S**  
 Ø 25

H. 740 X L. 145 mm.  
**Art. 08.045.48G**  
**Art. 08.045.48S**  
 Ø 30

FORO TONDO  
 ROUND HOLE

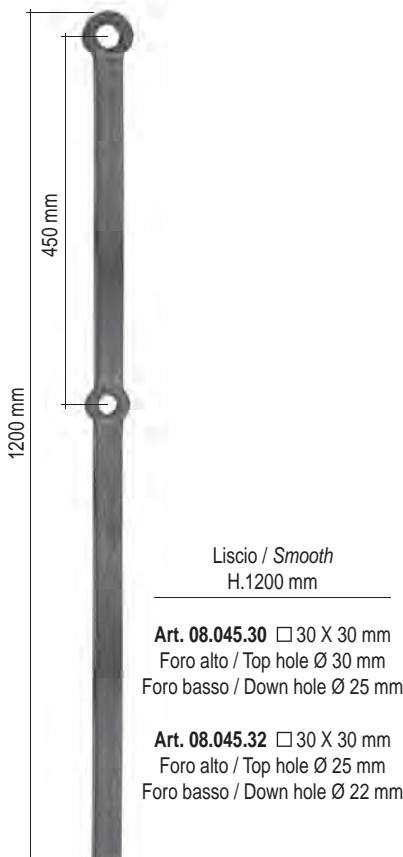

Liscio / Smooth  
 H.1200 mm

**Art. 08.045.30** □ 30 X 30 mm  
 Foro alto / Top hole Ø 30 mm  
 Foro basso / Down hole Ø 25 mm

**Art. 08.045.32** □ 30 X 30 mm  
 Foro alto / Top hole Ø 25 mm  
 Foro basso / Down hole Ø 22 mm

FORO QUADRO IN OBLIQUO  
 SLATING SQUARE HOLE

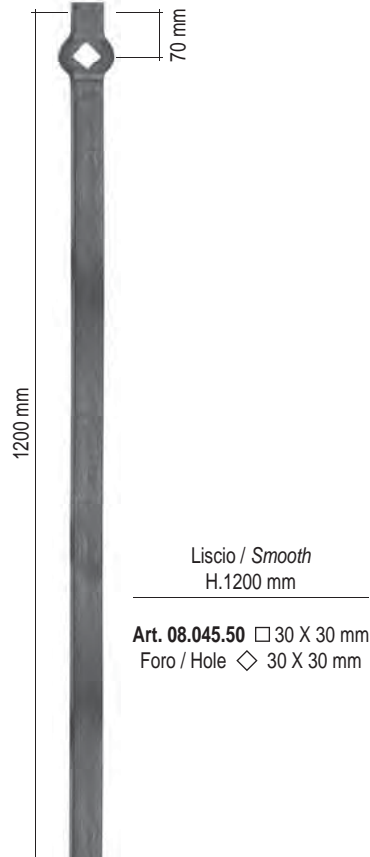

Liscio / Smooth  
 H.1200 mm

**Art. 08.045.50** □ 30 X 30 mm  
 Foro / Hole ◇ 30 X 30 mm



**BARRE FORATE  
HOLED BARS**

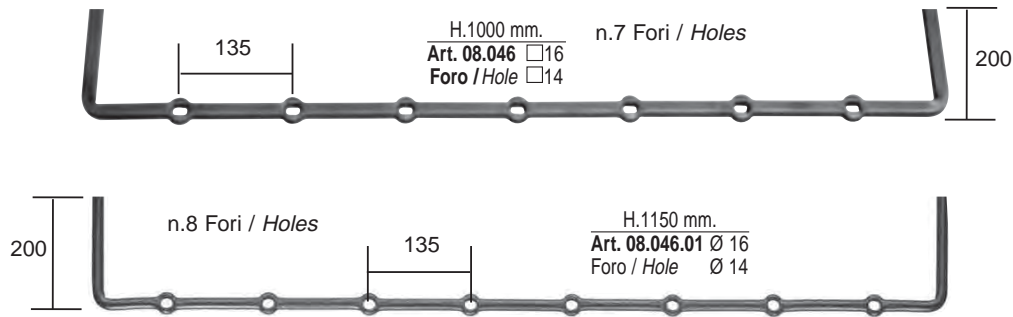

**INT. standard: 125 mm. - n. Fori 15**

MISURE STANDARD 2000 mm. / 2000 mm. STANDARD SIZE

INT. = INTERASSE / CENTRE DISTANCE

LUCE = DISTANCE BETWEEN HOLES

FORO = HOLE

<p><b>FORO QUADRO IN OBLIQUO SLANTING SQUARE HOLE</b></p> <p>INT. 125 15 Fori per barra Holes per bar</p> <p>H.2000 mm. Foro ◊ 12  <b>Art. 08.047</b> ≡ 30 X 8  <b>Art. 08.048</b> ≡ 30 X 10  <b>Art. 08.049</b> ≡ 35 X 8  <b>Art. 08.050</b> ≡ 35 X 10  <b>Art. 08.051</b> ≡ 40 X 8  <b>Art. 08.052</b> ≡ 40 X 10</p> <p>H.2000 mm. Foro ◊ 14  <b>Art. 08.053</b> ≡ 30 X 8  <b>Art. 08.054</b> ≡ 30 X 10  <b>Art. 08.055</b> ≡ 35 X 8  <b>Art. 08.056</b> ≡ 35 X 10  <b>Art. 08.057</b> ≡ 40 X 8  <b>Art. 08.058</b> ≡ 40 X 10</p> <p>H.2000 mm. Foro ◊ 16  <b>Art. 08.058.01</b> ≡ 30 X 8  <b>Art. 08.058.02</b> ≡ 30 X 10  <b>Art. 08.058.03</b> ≡ 35 X 8  <b>Art. 08.058.04</b> ≡ 35 X 10  <b>Art. 08.058.05</b> ≡ 40 X 8  <b>Art. 08.058.06</b> ≡ 40 X 10</p>	<p><b>FORO QUADRO IN OBLIQUO SLANTING SQUARE HOLE</b></p> <p>INT. 149</p> <p>INT. 149 mm. Luce 128 mm. n. Fori 12</p> <p>H.2000 mm. Foro ◊ 14  <b>Art. 08.058.07</b> ≡ 30 X 8  <b>Art. 08.058.08</b> ≡ 30 X 10</p>	<p><b>FORO QUADRO IN OBLIQUO SLANTING SQUARE HOLE</b></p> <p>INT. 74,5</p> <p>INT. 74,5 mm. Luce 53,5 mm. n. Fori 26</p> <p>H.2000 mm. Foro ◊ 14  <b>Art. 08.058.09</b> ≡ 30 X 8  <b>Art. 08.058.10</b> ≡ 30 X 10</p>	<p><b>FORO QUADRO SQUARE HOLE</b></p> <p>INT. 125 15 Fori per barra Holes per bar</p> <p>H.2000 mm. Foro □ 12  <b>Art. 08.059</b> ≡ 30 X 8  <b>Art. 08.060</b> ≡ 30 X 10  <b>Art. 08.061</b> ≡ 35 X 8  <b>Art. 08.062</b> ≡ 35 X 10  <b>Art. 08.063</b> ≡ 40 X 8  <b>Art. 08.064</b> ≡ 40 X 10</p> <p>H.2000 mm. Foro □ 14  <b>Art. 08.065</b> ≡ 30 X 8  <b>Art. 08.066</b> ≡ 30 X 10  <b>Art. 08.067</b> ≡ 35 X 8  <b>Art. 08.068</b> ≡ 35 X 10  <b>Art. 08.069</b> ≡ 40 X 8  <b>Art. 08.070</b> ≡ 40 X 10</p> <p>H.2000 mm. Foro □ 16  <b>Art. 08.070.01</b> ≡ 30 X 8  <b>Art. 08.070.02</b> ≡ 30 X 10  <b>Art. 08.070.03</b> ≡ 35 X 8  <b>Art. 08.070.04</b> ≡ 35 X 10  <b>Art. 08.070.05</b> ≡ 40 X 8  <b>Art. 08.070.06</b> ≡ 40 X 10</p>
--	--	---	--

<p>INT. 112</p> <p>INT. 112 17 Fori per barra 17 Holes per bar</p> <p>H. 2000 Foro / Hole ◊ 12  <b>Art. 08.046.100</b> ≡ 30 X 8 mm</p> <p>H. 2000 Foro / Hole ◊ 14  <b>Art. 08.046.106</b> ≡ 30 X 8 mm</p> <p>H. 2000 Foro / Hole ◊ 16  <b>Art. 08.046.112</b> ≡ 30 X 8 mm</p>	<p>INT. 112</p> <p>INT. 112 17 Fori per barra 17 Holes per bar</p> <p>H. 2000 Foro / Hole □ 12  <b>Art. 08.058.100</b> ≡ 30 X 8 mm</p> <p>H. 2000 Foro / Hole □ 14  <b>Art. 08.058.106</b> ≡ 30 X 8 mm</p> <p>H. 2000 Foro / Hole □ 16  <b>Art. 08.058.112</b> ≡ 30 X 8 mm</p>	<p>INT. 112</p> <p>INT. 112 17 Fori per barra 17 Holes per bar</p> <p>H. 2000 Foro / Hole Ø 12  <b>Art. 08.070.100</b> ≡ 30 X 8 mm</p> <p>H. 2000 Foro / Hole Ø 14  <b>Art. 08.070.106</b> ≡ 30 X 8 mm</p> <p>H. 2000 Foro / Hole Ø 16  <b>Art. 08.070.112</b> ≡ 30 X 8 mm</p>
--	--	--

**Le barre forate possono essere prodotte anche da 3000 mm. / Our flat punched bars are also available at 3 meter length.**

Tutte le parti di questo catalogo - foto comprese - sono di proprietà Euro-Fer. La riproduzione, anche parziale, è vietata in ogni forma e con ogni mezzo. / Every part of this catalogue - photos included - is Euro-Fer's property. All forms of copying are strictly prohibited.

INT. standard: 125 mm. - n. Fori 15

MISURE STANDARD 2000 mm. / 2000 mm. STANDARD SIZE

INT. = INTERASSE / CENTRE DISTANCE

LUCE = DISTANCE BETWEEN HOLES

FORO = HOLE



FORO QUADRO  
SQUARE HOLE



FORO QUADRO  
SQUARE HOLE

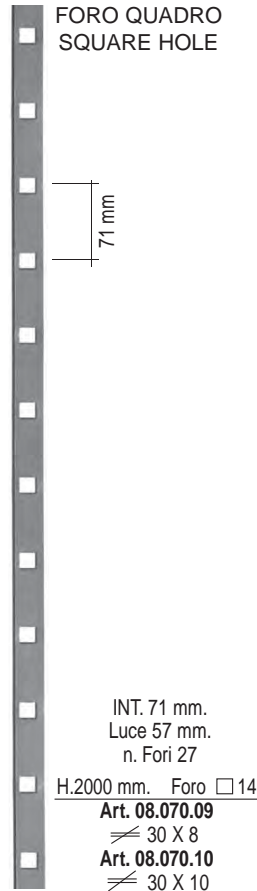

FORO TONDO  
ROUND HOLE

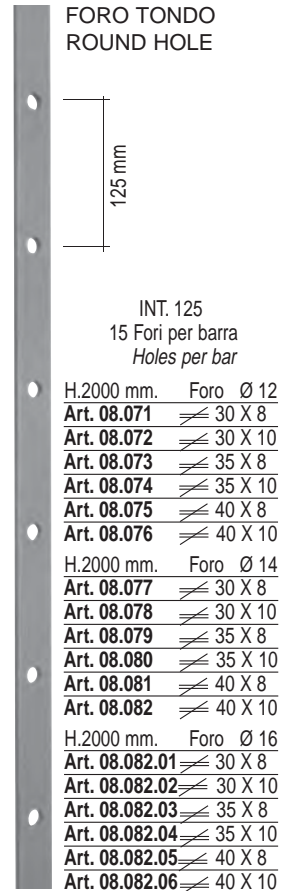

Piatto Martellato 4 Lati / *Hammered Flat* – 4 Sides

FORO QUADRO IN OBLIQUO  
SLANTING SQUARE HOLE

INT. 125  
15 Fori per barra / *Holes per bar*

H.2000 mm. Foro  $\diamond$  12

Art. 08.082.20  $\neq$  30 X 8  
Art. 08.082.21  $\neq$  30 X 10  
Art. 08.082.22  $\neq$  35 X 8  
Art. 08.082.23  $\neq$  35 X 10  
Art. 08.082.24  $\neq$  40 X 8  
Art. 08.082.25  $\neq$  40 X 10

H.2000 mm. Foro  $\diamond$  14

Art. 08.082.26  $\neq$  30 X 8  
Art. 08.082.27  $\neq$  30 X 10  
Art. 08.082.28  $\neq$  35 X 8  
Art. 08.082.29  $\neq$  35 X 10  
Art. 08.082.30  $\neq$  40 X 8  
Art. 08.082.31  $\neq$  40 X 10

H.2000 mm. Foro  $\diamond$  16

Art. 08.082.32  $\neq$  30 X 8  
Art. 08.082.33  $\neq$  30 X 10  
Art. 08.082.34  $\neq$  35 X 8  
Art. 08.082.35  $\neq$  35 X 10  
Art. 08.082.36  $\neq$  40 X 8  
Art. 08.082.37  $\neq$  40 X 10

FORO QUADRO  
SQUARE HOLE

INT. 125  
15 Fori per barra / *Holes per bar*

H.2000 mm.  $\square$  12 X 12

Art. 08.082.38  $\neq$  30 X 8  
Art. 08.082.39  $\neq$  30 X 10  
Art. 08.082.40  $\neq$  35 X 8  
Art. 08.082.41  $\neq$  35 X 10  
Art. 08.082.42  $\neq$  40 X 8  
Art. 08.082.43  $\neq$  40 X 10

H.2000 mm.  $\square$  14 X 14

Art. 08.082.44  $\neq$  30 X 8  
Art. 08.082.45  $\neq$  30 X 10  
Art. 08.082.46  $\neq$  35 X 8  
Art. 08.082.47  $\neq$  35 X 10  
Art. 08.082.48  $\neq$  40 X 8  
Art. 08.082.49  $\neq$  40 X 10

H.2000 mm.  $\square$  16 X 16

Art. 08.082.50  $\neq$  30 X 8  
Art. 08.082.51  $\neq$  30 X 10  
Art. 08.082.52  $\neq$  35 X 8  
Art. 08.082.53  $\neq$  35 X 10  
Art. 08.082.54  $\neq$  40 X 8  
Art. 08.082.55  $\neq$  40 X 10

FORO TONDO  
ROUND HOLE

INT. 125  
15 Fori per barra / *Holes per bar*

H.2000 mm.  $\circ$  12

Art. 08.082.56  $\neq$  30 X 8  
Art. 08.082.57  $\neq$  30 X 10  
Art. 08.082.58  $\neq$  35 X 8  
Art. 08.082.59  $\neq$  35 X 10  
Art. 08.082.60  $\neq$  40 X 8  
Art. 08.082.61  $\neq$  40 X 10

H.2000 mm.  $\circ$  14

Art. 08.082.62  $\neq$  30 X 8  
Art. 08.082.63  $\neq$  30 X 10  
Art. 08.082.64  $\neq$  35 X 8  
Art. 08.082.65  $\neq$  35 X 10  
Art. 08.082.66  $\neq$  40 X 8  
Art. 08.082.67  $\neq$  40 X 10

H.2000 mm.  $\circ$  16

Art. 08.082.68  $\neq$  30 X 8  
Art. 08.082.69  $\neq$  30 X 10  
Art. 08.082.70  $\neq$  35 X 8  
Art. 08.082.71  $\neq$  35 X 10  
Art. 08.082.72  $\neq$  40 X 8  
Art. 08.082.73  $\neq$  40 X 10

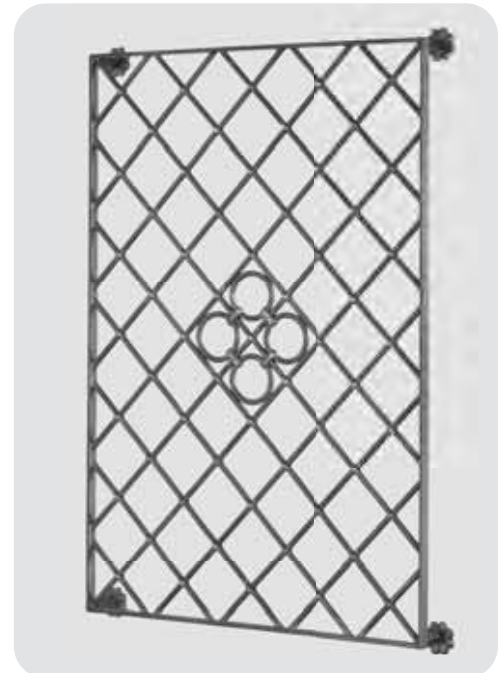

**Le barre forate possono essere prodotte anche da 3000 mm. / Our flat punched bars are also available at 3 meter length.**

Tutte le parti di questo catalogo - foto comprese - sono di proprietà Euro-Fer. La riproduzione, anche parziale, è vietata in ogni forma e con ogni mezzo. / Every part of this catalogue - photos included - is Euro-Fer's property. All forms of copying are strictly prohibited.

## BARRE FORATE HOLED BARS

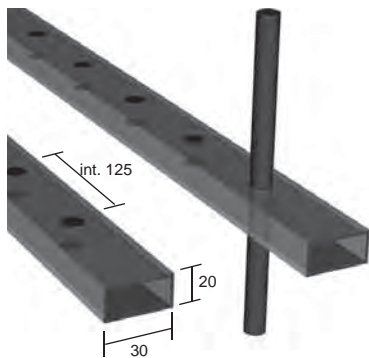

**30 x 20 x 2 mm**

Tubo liscio / Plain

int. 125 mm - fori passanti / int. 125 mm - fully drilled holes

	H. 2000	
Art. 08.082.100	foro Ø 12	nr. 15 fori
Art. 08.082.101	foro Ø 14	nr. 15 fori
Art. 08.082.102	foro □ 12	nr. 15 fori

	H. 3000	
Art. 08.082.105	foro Ø 12	nr. 23 fori
Art. 08.082.106	foro Ø 14	nr. 23 fori
Art. 08.082.107	foro □ 12	nr. 23 fori

Fuori Produzione / Out of Production  
H. 6000

Art. 08.082.110	foro Ø 12	nr. 47 fori
Art. 08.082.111	foro Ø 14	nr. 47 fori
Art. 08.082.112	foro □ 12	nr. 47 fori

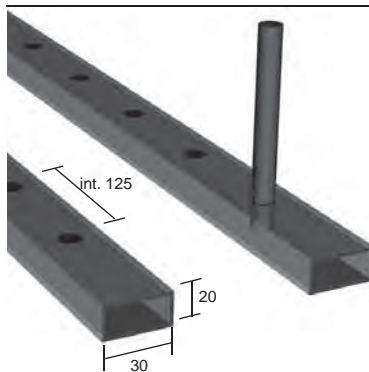

**30 x 20 x 2 mm**

Tubo liscio / Plain

int. 125 mm - fori in battuta / int. 125 mm - part drilled holes

	H. 2000	
Art. 08.082.115	foro Ø 12	nr. 15 fori
Art. 08.082.116	foro □ 12	nr. 15 fori

	H. 3000	
Art. 08.082.118	foro Ø 12	nr. 23 fori
Art. 08.082.119	foro □ 12	nr. 23 fori

Fuori Produzione / Out of Production  
H. 6000

Art. 08.082.121	foro Ø 12	nr. 47 fori
Art. 08.082.122	foro □ 12	nr. 47 fori

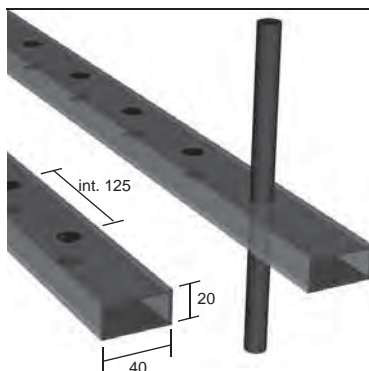

**40 x 20 x 2 mm**

Tubo liscio / Plain

int. 125 mm - fori passanti / int. 125 mm - fully drilled holes

	H. 2000	
Art. 08.082.148	foro Ø 12	nr. 15 fori
Art. 08.082.149	foro Ø 14	nr. 15 fori
Art. 08.082.154	foro □ 12	nr. 15 fori
Art. 08.082.155	foro □ 14	nr. 15 fori

	H. 3000	
Art. 08.082.163	foro Ø 12	nr. 23 fori
Art. 08.082.164	foro Ø 14	nr. 23 fori
Art. 08.082.169	foro □ 12	nr. 23 fori
Art. 08.082.170	foro □ 14	nr. 23 fori

Fuori Produzione / Out of Production  
H. 6000

Art. 08.082.178	foro Ø 12	nr. 47 fori
Art. 08.082.179	foro Ø 14	nr. 47 fori
Art. 08.082.184	foro □ 12	nr. 47 fori
Art. 08.082.185	foro □ 14	nr. 47 fori

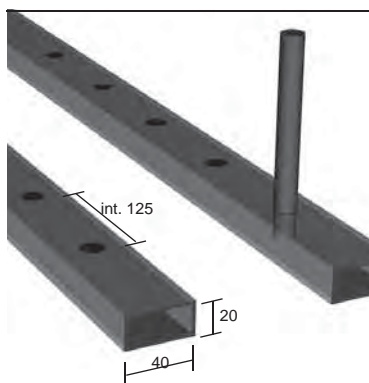

**40 x 20 x 2 mm - Tubo liscio / Plain**

int. 125 mm - fori in battuta / int. 125 mm - part drilled holes

	H. 2000	
Art. 08.082.194	foro Ø 14	nr. 15 fori
Art. 08.082.200	foro □ 14	nr. 15 fori

	H. 3000	
Art. 08.082.208	foro Ø 14	nr. 23 fori
Art. 08.082.214	foro □ 14	nr. 23 fori

Fuori Produzione / Out of Production  
H. 6000

Art. 08.082.222	foro Ø 14	nr. 47 fori
Art. 08.082.228	foro □ 14	nr. 47 fori

a richiesta foro Ø 12 mm e □ 12 mm / on request hole Ø 12 mm and □ 12 mm

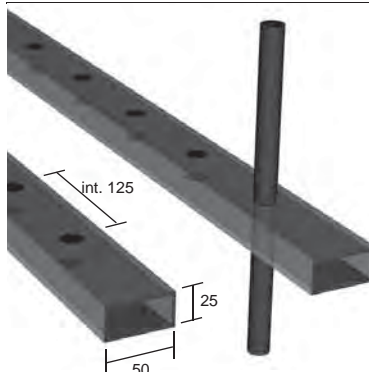

**50 x 25 x 2 mm - Tubo liscio / Plain**

int. 125 mm - fori passanti / int. 125 mm - fully drilled holes

	H. 2000	
Art. 08.082.323	foro Ø 14	nr. 15 fori
Art. 08.082.330	foro □ 14	nr. 15 fori

	H. 3000	
Art. 08.082.340	foro Ø 14	nr. 23 fori
Art. 08.082.347	foro □ 14	nr. 23 fori

Fuori Produzione / Out of Production  
H. 6000

Art. 08.082.357	foro Ø 14	nr. 47 fori
Art. 08.082.364	foro □ 14	nr. 47 fori

a richiesta foro Ø 12 mm e □ 12 mm / on request hole Ø 12 mm and □ 12 mm



## 50 x 25 x 2 mm - Tubo liscio / Plain int. 125 mm - fori in battuta / int. 125 mm - part drilled holes

H. 2000			H. 3000		
Art. 08.082.374	foro Ø 14	nr. 15 fori	Art. 08.082.390	foro Ø 14	nr. 23 fori
Art. 08.082.381	foro □ 14	nr. 15 fori	Art. 08.082.397	foro □ 14	nr. 23 fori

Fuori Produzione / Out of Production		
H. 6000		
Art. 08.082.406	foro Ø 14	nr. 47 fori
Art. 08.082.413	foro □ 14	nr. 47 fori

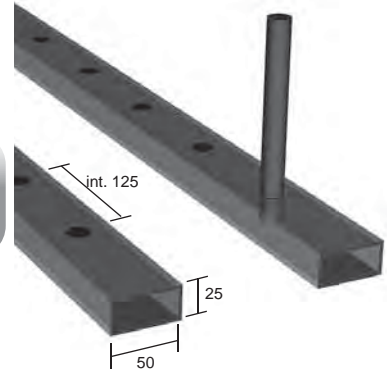

a richiesta foro Ø 12 mm e □ 12 mm / on request hole Ø 12 mm and □ 12 mm

## 40 x 40 x 3 mm - Tubo liscio / Plain int. 125 mm - fori passanti / int. 125 mm - fully drilled holes

H. 2000			H. 3000		
Art. 08.082.510	foro Ø 12	nr. 15 fori	Art. 08.082.520	foro Ø 12	nr. 23 fori
Art. 08.082.511	foro Ø 14	nr. 15 fori	Art. 08.082.521	foro Ø 14	nr. 23 fori
Art. 08.082.512	foro □ 12	nr. 15 fori	Art. 08.082.522	foro □ 12	nr. 23 fori
Art. 08.082.513	foro □ 14	nr. 15 fori	Art. 08.082.523	foro □ 14	nr. 23 fori

Fuori Produzione / Out of Production		
H. 6000		
Art. 08.082.530	foro Ø 12	nr. 47 fori
Art. 08.082.531	foro Ø 14	nr. 47 fori
Art. 08.082.532	foro □ 12	nr. 47 fori
Art. 08.082.533	foro □ 14	nr. 47 fori

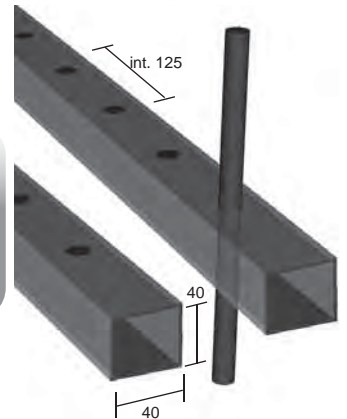

Su richiesta è possibile realizzare tubi forati di diverse lunghezze e con diverse misure di interasse  
*Customized sizes and dimensions available on demand*

Per realizzare un tubo forato a misura dovete indicare /  
For customized items please indicate:

### Tipo di tubo / Type of tube

- 30x20 x 2mm Tubo Liscio / Plain
- 40x20 x 2mm Tubo Liscio / Plain
- 40x40 x 3mm Tubo Liscio / Plain
- 50x25 x 2mm Tubo Liscio / Plain

### fori passanti / fully drilled holes

### fori in battuta / part drilled holes

### Numero dei fori / Number of holes

### Tipo di fori e dimensioni / Kind and sizes of hole

- mm
- Ø  mm

Lunghezza tubo / Tube lenght

Int. A / Int. A

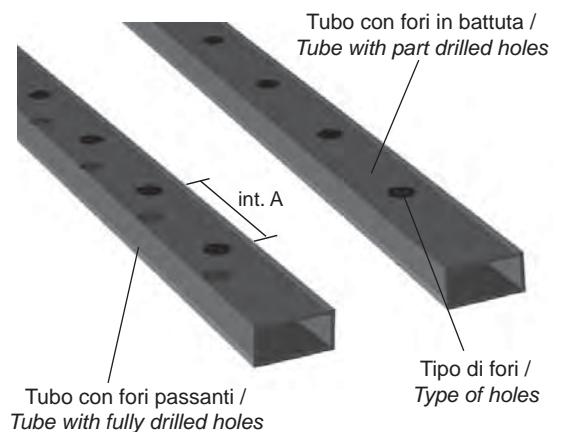

<b>Cliente</b>	<b>Data</b>
<b>Timbro e Firma</b>	<b>Note</b>

Tutte le parti di questo catalogo - foto comprese - sono di proprietà Euro-Fer. La riproduzione, anche parziale, è vietata in ogni forma e con ogni mezzo. / Every part of this catalogue - photos included - is Euro-Fer's property. All forms of copying are strictly prohibited.



H.6000 mm. □ 12 X 12	
Art. 08.083	INT. 120
Art. 08.084	INT. 140
Art. 08.085	INT. 160
Art. 08.086	INT. 180
Art. 08.087	INT. 200
Art. 08.088	INT. 300
H.6000 mm. □ 14 X 14	
Art. 08.089	INT. 120
Art. 08.090	INT. 140
Art. 08.091	INT. 160
Art. 08.092	INT. 180
Art. 08.093	INT. 200
Art. 08.094	INT. 300



H.2000 mm. ≇ 20x4	
Art. 08.094.50	INT. 120
Art. 08.094.51	INT. 160

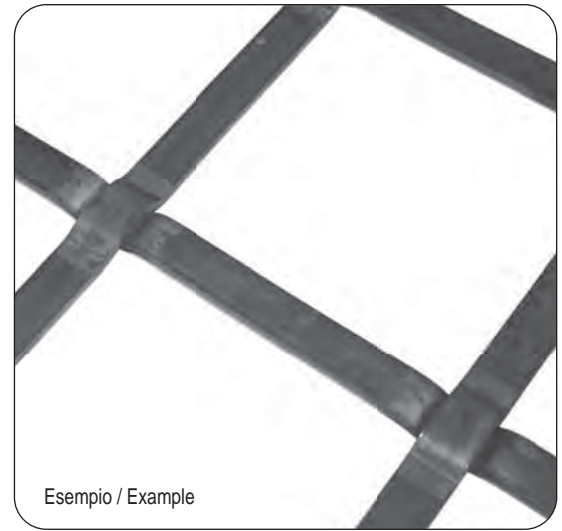

Esempio / Example

## SALISBURGHESI

LE BARRE "SALISBURGHESI" SONO FORNITE SINGOLARMENTE: SONO ACCOPPIATE SOLO A TITOLO DIMOSTRATIVO.  
THE "SALISBURGHESI" BARS ARE SUPPLIED SEPARATELY: THEY ARE ONLY IN PAIRS FOR DEMONSTRATION PURPOSES.

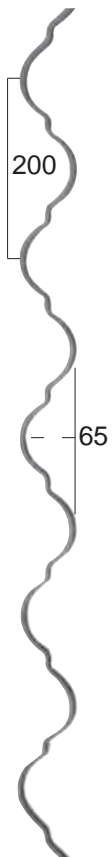

H.2500 X L.65 mm.  
Art. 08.095  
≇ 16 X 5

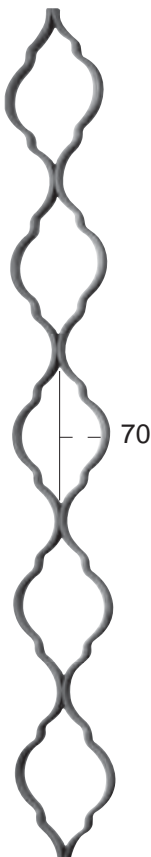

H.2500 X L.70 mm.  
Art. 08.096 ≇ 16 X 8  
Rigato / Striped

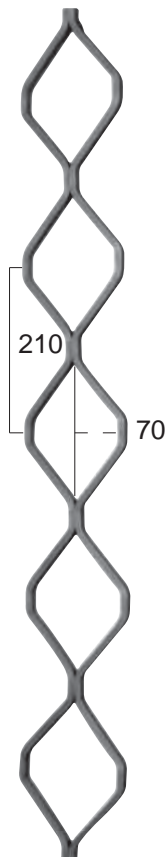

H.2500 X L.70 mm.  
Art. 08.097 ≇ 16 X 8  
Rigato / Striped



H.2500 X L.65 mm.  
Art. 08.098 ≇ 16 X 8  
Art. 08.099 Ø 10  
Art. 08.100 Ø 12

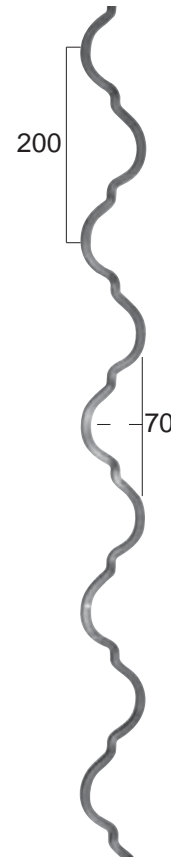

H.2500 X L.70 mm.  
Art. 08.101 □ 8  
Art. 08.102 □ 10  
Art. 08.103 □ 12

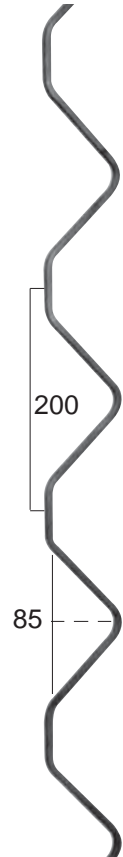

H.2500 X L.85 mm.  
Art. 08.104  
□ 8 X 8



Spazio per inserimento □ 14 mm.  
Space for square insert □ 14 mm.

FORO  
OBLIQUO  
SLANTING  
HOLE



Martellato / *Hammered*  
H.2000 mm. □ 14 X 14  
Art. 08.105 INT.125 mm.  
N. Nocchie / *Knobs* 16

Liscio / *Smooth*  
H.2000 mm. □ 14 X 14  
Art. 08.105.01 INT.125 mm.  
N. Nocchie / *Knobs* 16

H.2000 mm. ≇ 50 X 20  
Art. 08.105.02 INT.130 mm.  
Luce 105 mm.  
N. Fori / *Holes* 14 ◇ 22

PIATTI CON RIBATTINI STAMPATI  
PLAT BARS WITH FORGED RIVETS



PIATTO LISCIO  
SMOOTH FLAT

H.2000 mm.  
Art. 08.182  
≇ 30 X 6  
INT. 125 mm.



PIATTO MARTELLATO  
HAMMERED  
FLAT

H.2000 mm.  
Art. 08.183  
≇ 30 X 6  
INT. 125 mm.



PIATTO SAGOMATO  
MODELLED  
FLAT

H.2000 mm.  
Art. 08.184  
≇ 30 X 8  
INT. 132 mm.

H.3000 mm.  
Art. 08.184.01  
≇ 30 X 8  
INT. 132 mm.



Liscio / *Smooth*  
Foro ad asola / *Buttonhole*  
H.2000 mm ≇ 40 x 8 mm

Art. 08.199 fori / hole □ 12 mm - int. 130 mm - n°14 fori / holes  
Art. 08.199.01 fori / hole □ 12 mm - int. 135 mm - n°14 fori / holes  
Art. 08.199.02 fori / hole □ 14 mm - int. 130 mm - n°14 fori / holes  
Art. 08.199.03 fori / hole □ 14 mm - int. 135 mm - n°14 fori / holes  
Art. 08.200 fori / hole □ 16 mm - int. 130 mm - n°14 fori / holes  
Art. 08.200.01 fori / hole □ 16 mm - int. 135 mm - n°14 fori / holes



Martellato / *Hammered*  
Foro ad asola / *Buttonhole*  
H.2000 mm ≇ 40 x 8 mm

Art. 08.200.10 fori / hole □ 12 mm - int. 130 mm - n°14 fori / holes  
Art. 08.200.11 fori / hole □ 12 mm - int. 135 mm - n°14 fori / holes  
Art. 08.200.12 fori / hole □ 14 mm - int. 130 mm - n°14 fori / holes  
Art. 08.200.13 fori / hole □ 14 mm - int. 135 mm - n°14 fori / holes  
Art. 08.201 fori / hole □ 16 mm - int. 130 mm - n°14 fori / holes  
Art. 08.201.01 fori / hole □ 16 mm - int. 135 mm - n°14 fori / holes

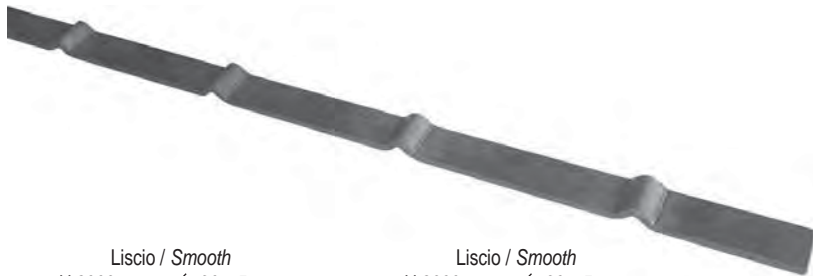

Liscio / *Smooth*  
H.2000 mm ≇ 30 x 5 mm  
Art. 08.210 □ 14 mm - int. 130 mm  
Art. 08.211 □ 14 mm - int. 145 mm

Liscio / *Smooth*  
H.2000 mm ≇ 30 x 5 mm  
Art. 08.214 □ 16 mm - int. 130 mm  
Art. 08.215 □ 16 mm - int. 145 mm

Liscio / *Smooth*  
H.3000 mm ≇ 30 x 5 mm  
Art. 08.212 □ 14 mm - int. 130 mm  
Art. 08.213 □ 14 mm - int. 145 mm

Liscio / *Smooth*  
H.3000 mm ≇ 30 x 5 mm  
Art. 08.216 □ 16 mm - int. 130 mm  
Art. 08.217 □ 16 mm - int. 145 mm

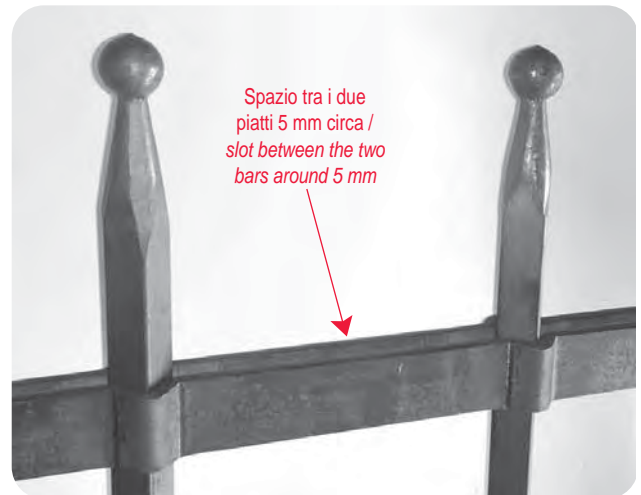

Spazio tra i due  
piatti 5 mm circa /  
slot between the two  
bars around 5 mm



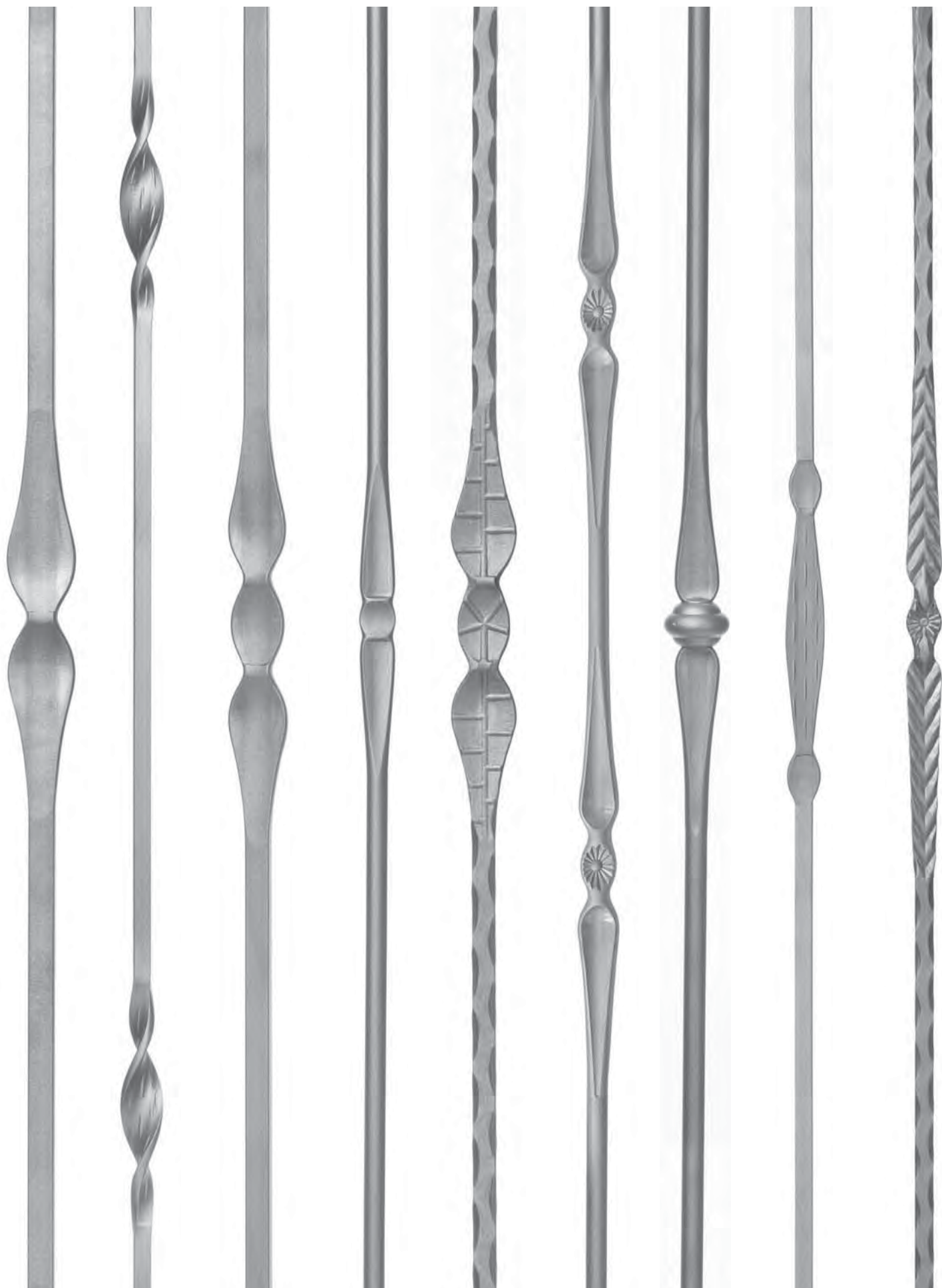

Tutte le parti di questo catalogo - foto comprese - sono di proprietà Euro-Fer. La riproduzione, anche parziale, è vietata in ogni forma e con ogni mezzo. / Every part of this catalogue - photos included - is Euro-Fer's property. All forms of copying are strictly prohibited.

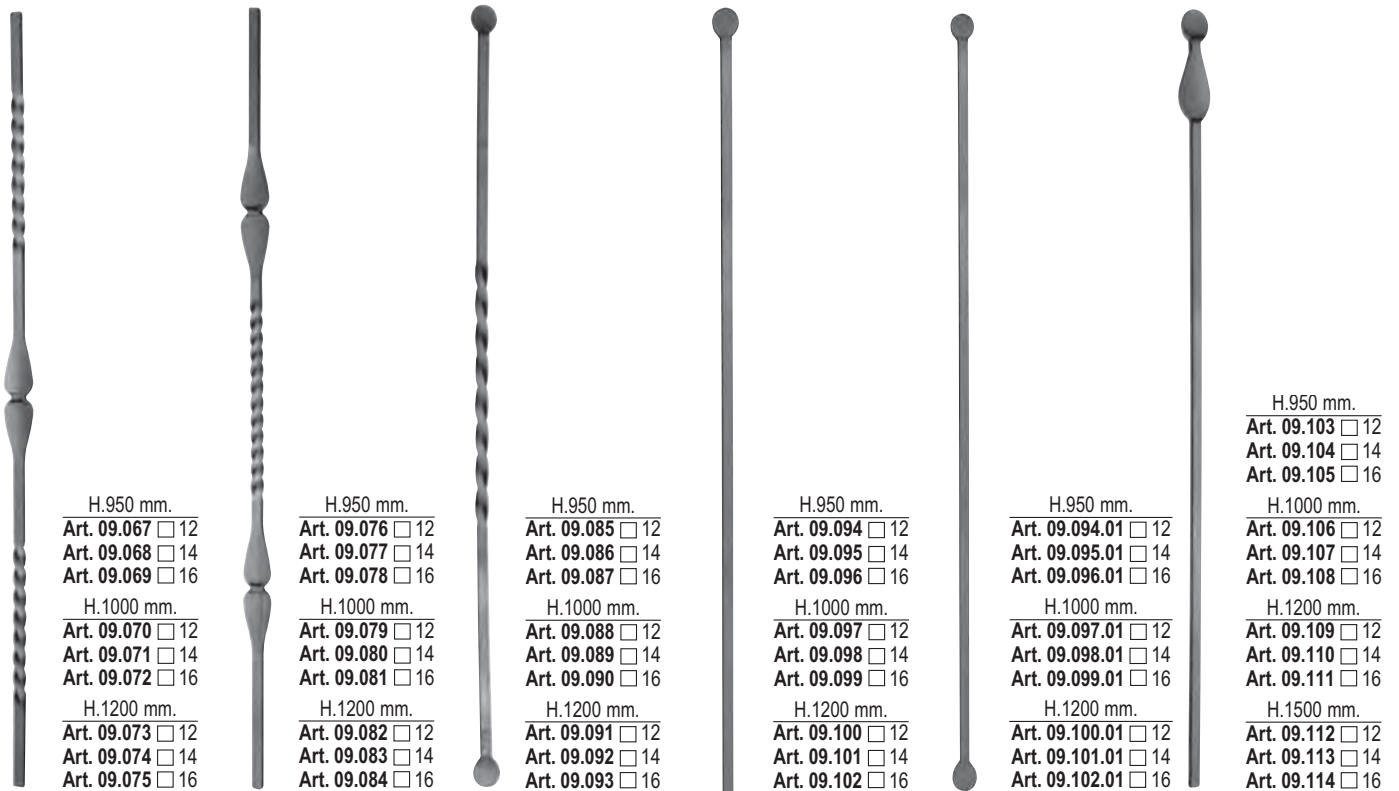
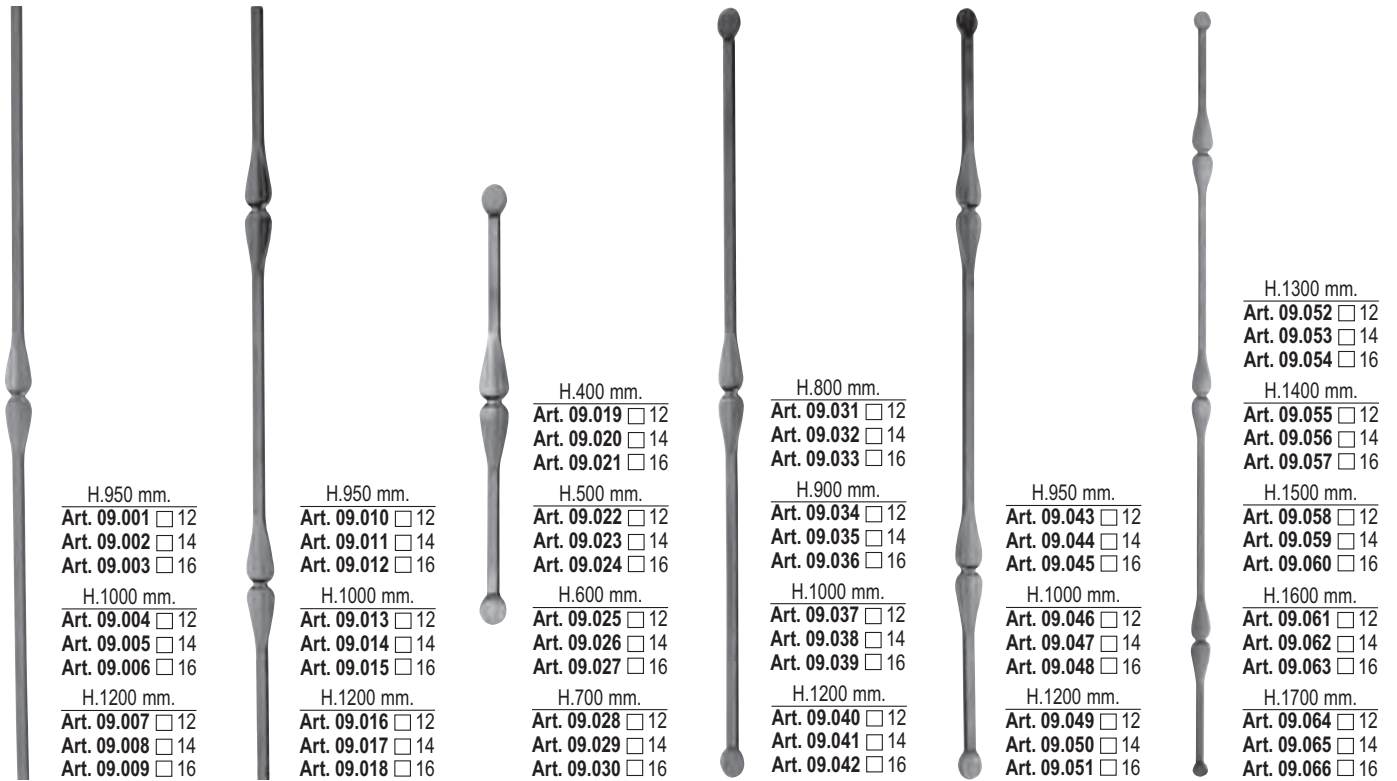

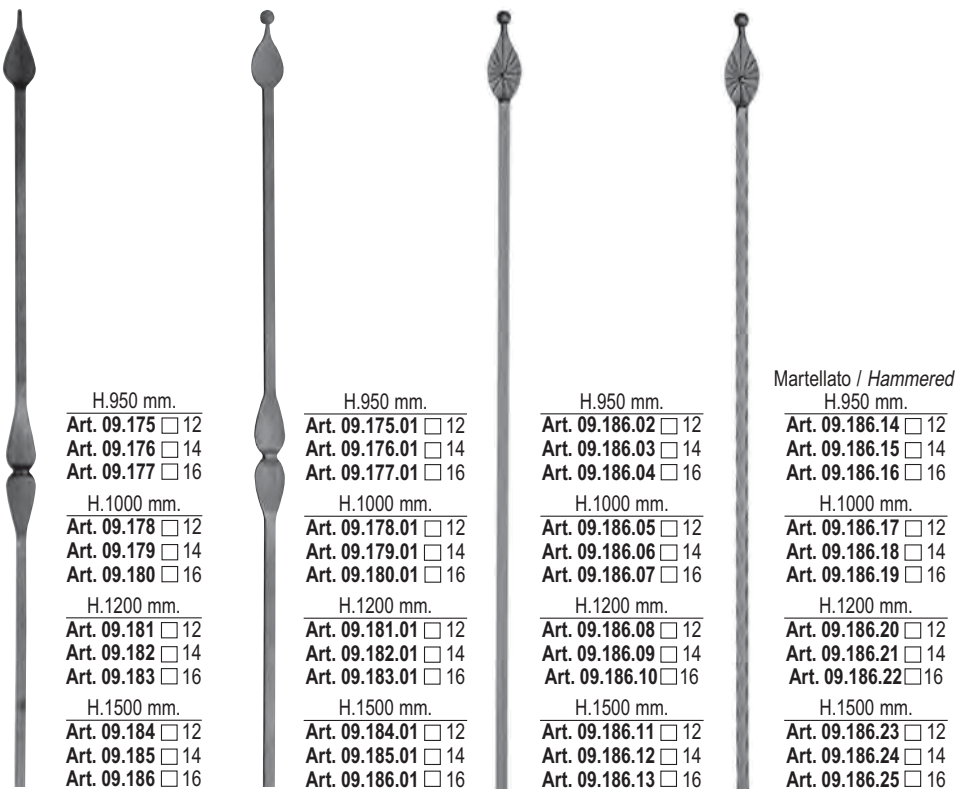
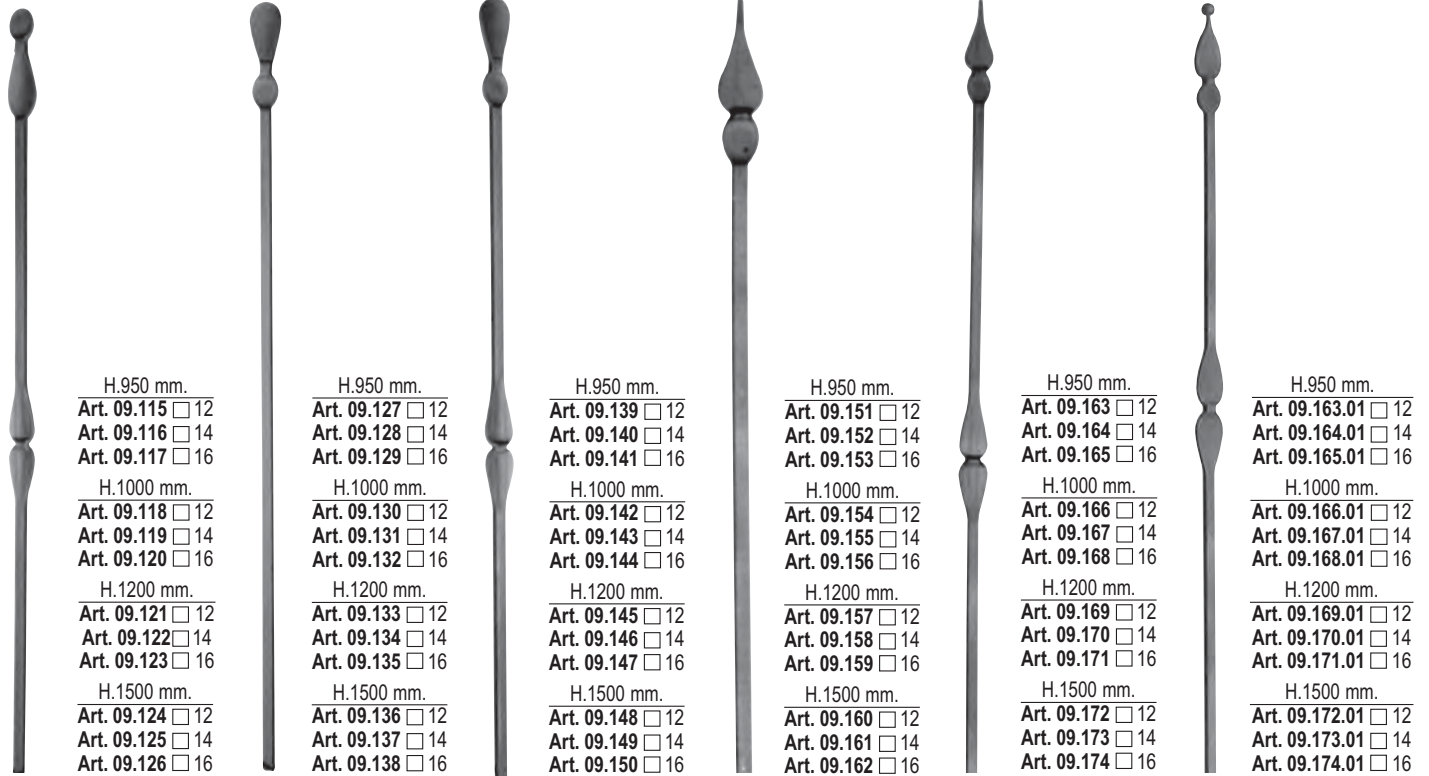

A RICHIESTA CON PALLINA SULLA LANCIA  
ON REQUEST WITH BALL ON THE SPEAR



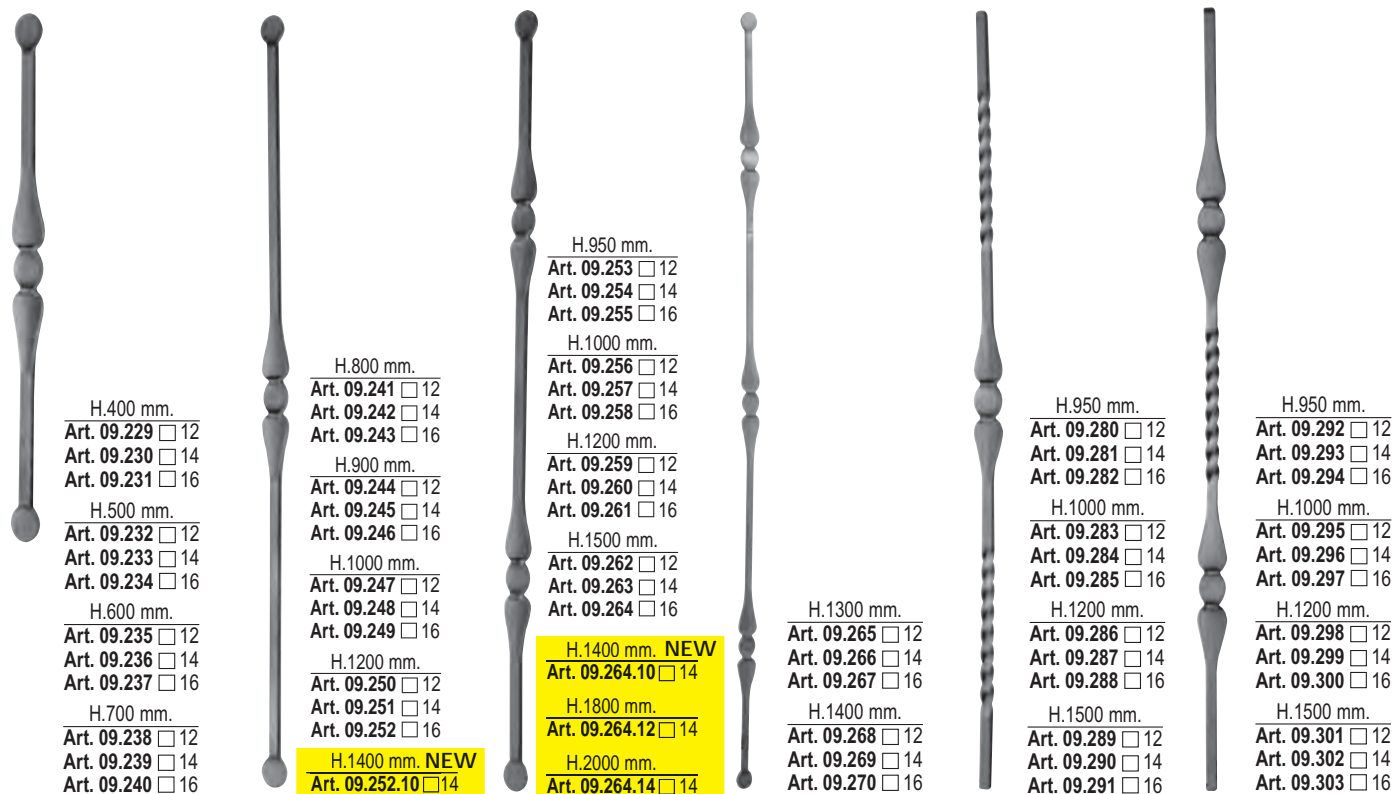
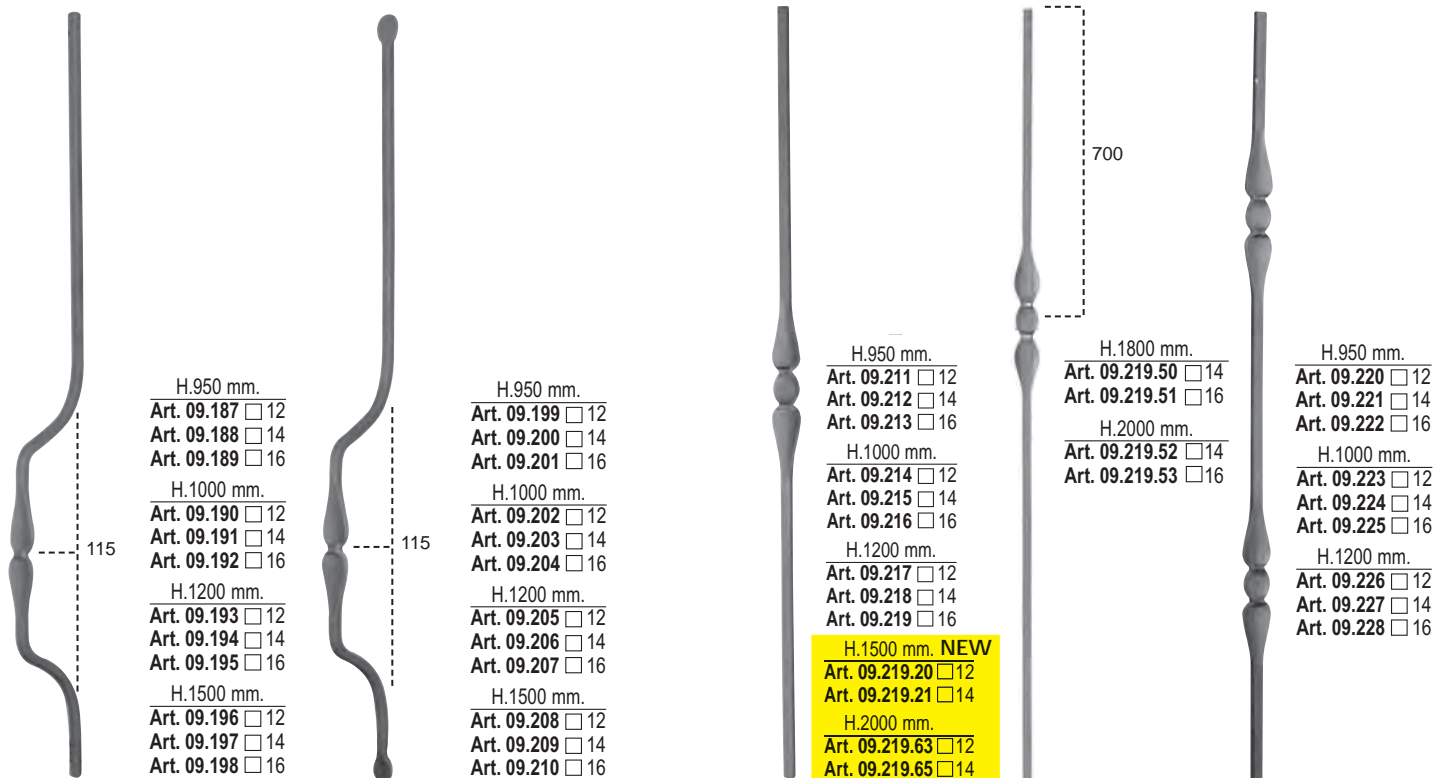

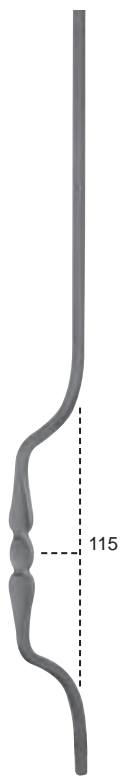

- H.950 mm.
- Art. 09.304  12
- Art. 09.305  14
- Art. 09.306  16
- H.1000 mm.
- Art. 09.307  12
- Art. 09.308  14
- Art. 09.309  16
- H.1200 mm.
- Art. 09.310  12
- Art. 09.311  14
- Art. 09.312  16
- H.1500 mm.
- Art. 09.313  12
- Art. 09.314  14
- Art. 09.315  16
- H.1800 mm.
- Art. 09.316  12
- Art. 09.317  14
- Art. 09.318  16



- H.950 mm.
- Art. 09.319  12
- Art. 09.320  14
- Art. 09.321  16
- H.1000 mm.
- Art. 09.322  12
- Art. 09.323  14
- Art. 09.324  16
- H.1200 mm.
- Art. 09.325  12
- Art. 09.326  14
- Art. 09.327  16
- H.1500 mm.
- Art. 09.328  12
- Art. 09.329  14
- Art. 09.330  16
- H.1800 mm.
- Art. 09.331  12
- Art. 09.332  14
- Art. 09.333  16



- H.950 mm.
- Art. 09.334  12
- Art. 09.335  14
- Art. 09.336  16
- H.1000 mm.
- Art. 09.337  12
- Art. 09.338  14
- Art. 09.339  16
- H.1200 mm.
- Art. 09.340  12
- Art. 09.341  14
- Art. 09.342  16
- H.1500 mm.
- Art. 09.343  12
- Art. 09.344  14
- Art. 09.345  16
- H.1800 mm.
- Art. 09.346  12
- Art. 09.347  14
- Art. 09.348  16



- H.900 mm. **NEW**
- Art. 09.348.50  12
- Art. 09.348.51  14
- H.950 mm.
- Art. 09.349  12
- Art. 09.350  14
- Art. 09.351  16
- H.1000 mm.
- Art. 09.352  12
- Art. 09.353  14
- Art. 09.354  16
- H.1200 mm.
- Art. 09.355  12
- Art. 09.356  14
- Art. 09.357  16
- H.1400 mm. **NEW**
- Art. 09.363.20  14
- H.1500 mm.
- Art. 09.358  12
- Art. 09.359  14
- Art. 09.360  16
- H.1800 mm.
- Art. 09.361  12
- Art. 09.362  14
- Art. 09.363  16
- H.1600 mm. **NEW**
- Art. 09.363.23  14
- H.1700 mm.
- Art. 09.363.26  14
- H.1800 mm.
- Art. 09.363.29  14



- H.950 mm.
- Art. 09.364  12
- Art. 09.365  14
- Art. 09.366  16
- H.1000 mm.
- Art. 09.367  12
- Art. 09.368  14
- Art. 09.369  16
- H.1200 mm.
- Art. 09.370  12
- Art. 09.371  14
- Art. 09.372  16
- H.1500 mm.
- Art. 09.373  12
- Art. 09.374  14
- Art. 09.375  16
- H.1800 mm.
- Art. 09.376  12
- Art. 09.377  14



- H.950 mm.
- Art. 09.379  12
- Art. 09.380  14
- Art. 09.381  16
- H.1000 mm.
- Art. 09.382  12
- Art. 09.383  14
- Art. 09.384  16
- H.1200 mm.
- Art. 09.385  12
- Art. 09.386  14
- Art. 09.387  16
- H.1500 mm.
- Art. 09.388  12
- Art. 09.389  14
- Art. 09.390  16
- H.1800 mm.
- Art. 09.391  12
- Art. 09.392  14
- Art. 09.393  16



- H.950 mm.
- Art. 09.394  12
- Art. 09.395  14
- Art. 09.396  16
- H.1000 mm.
- Art. 09.397  12
- Art. 09.398  14
- Art. 09.399  16
- H.1200 mm.
- Art. 09.400  12
- Art. 09.401  14
- Art. 09.402  16
- H.1500 mm.
- Art. 09.403  12
- Art. 09.404  14
- Art. 09.405  16



- H.950 mm.
- Art. 09.406  12
- Art. 09.407  14
- Art. 09.408  16
- H.1000 mm.
- Art. 09.409  12
- Art. 09.410  14
- Art. 09.411  16
- H.1200 mm.
- Art. 09.412  12
- Art. 09.413  14
- Art. 09.414  16
- H.1500 mm.
- Art. 09.415  12
- Art. 09.416  14
- Art. 09.417  16



- H.950 mm.
- Art. 09.418  12
- Art. 09.419  14
- Art. 09.420  16
- H.1000 mm.
- Art. 09.421  12
- Art. 09.422  14
- Art. 09.423  16
- H.1200 mm.
- Art. 09.424  12
- Art. 09.425  14
- Art. 09.426  16
- H.1500 mm.
- Art. 09.427  12
- Art. 09.428  14
- Art. 09.429  16



A RICHIESTA CON PALLINA SULLA LANCIA  
ON REQUEST WITH BALL ON THE SPEAR



H.950 mm.  
 Art. 09.430 □ 12  
 Art. 09.431 □ 14  
 Art. 09.432 □ 16

H.1000 mm.  
 Art. 09.433 □ 12  
 Art. 09.434 □ 14  
 Art. 09.435 □ 16

H.1200 mm.  
 Art. 09.436 □ 12  
 Art. 09.437 □ 14  
 Art. 09.438 □ 16

H.1500 mm.  
 Art. 09.439 □ 12  
 Art. 09.440 □ 14  
 Art. 09.441 □ 16



H.950 mm.  
 Art. 09.442 □ 12  
 Art. 09.443 □ 14  
 Art. 09.444 □ 16

H.1000 mm.  
 Art. 09.445 □ 12  
 Art. 09.446 □ 14  
 Art. 09.447 □ 16

H.1200 mm.  
 Art. 09.448 □ 12  
 Art. 09.449 □ 14  
 Art. 09.450 □ 16

H.1500 mm.  
 Art. 09.451 □ 12  
 Art. 09.452 □ 14  
 Art. 09.453 □ 16



H.950 mm.  
 Art. 09.442.01 □ 12  
 Art. 09.443.01 □ 14  
 Art. 09.444.01 □ 16

H.1000 mm.  
 Art. 09.445.01 □ 12  
 Art. 09.446.01 □ 14  
 Art. 09.447.01 □ 16

H.1200 mm.  
 Art. 09.448.01 □ 12  
 Art. 09.449.01 □ 14  
 Art. 09.450.01 □ 16

H.1500 mm.  
 Art. 09.451.01 □ 12  
 Art. 09.452.01 □ 14  
 Art. 09.453.01 □ 16



H.950 mm.  
 Art. 09.454 □ 12  
 Art. 09.455 □ 14  
 Art. 09.456 □ 16

H.1000 mm.  
 Art. 09.457 □ 12  
 Art. 09.458 □ 14  
 Art. 09.459 □ 16

H.1200 mm.  
 Art. 09.460 □ 12  
 Art. 09.461 □ 14  
 Art. 09.462 □ 16

H.1500 mm.  
 Art. 09.463 □ 12  
 Art. 09.464 □ 14  
 Art. 09.465 □ 16



H.950 mm.  
 Art. 09.454.01 □ 12  
 Art. 09.455.01 □ 14  
 Art. 09.456.01 □ 16

H.1000 mm.  
 Art. 09.457.01 □ 12  
 Art. 09.458.01 □ 14  
 Art. 09.459.01 □ 16

H.1200 mm.  
 Art. 09.460.01 □ 12  
 Art. 09.461.01 □ 14  
 Art. 09.462.01 □ 16

H.1500 mm.  
 Art. 09.463.01 □ 12  
 Art. 09.464.01 □ 14  
 Art. 09.465.01 □ 16



H.950 X L.175 mm.  
 Art. 09.466  
 □ 12 ≧ 12 X 6



H.950 X L.175 mm.  
 Art. 09.467  
 □ 12 ≧ 12 X 6



H.950 X L.150 mm.  
 Art. 09.468  
 □ 12 ≧ 12 X 6



Martel. / Hammered  
 H.950 mm.  
 Art. 09.468.01 □ 12  
 Art. 09.468.02 □ 14  
 Art. 09.468.03 □ 16

H.1000 mm.  
 Art. 09.468.04 □ 12  
 Art. 09.468.05 □ 14  
 Art. 09.468.06 □ 16

H.1200 mm.  
 Art. 09.468.07 □ 12  
 Art. 09.468.08 □ 14  
 Art. 09.468.09 □ 16

H.1500 mm.  
 Art. 09.468.10 □ 12  
 Art. 09.468.11 □ 14  
 Art. 09.468.12 □ 16



Martel. / Hammered  
 H.950 mm.  
 Art. 09.468.13 □ 12  
 Art. 09.468.14 □ 14  
 Art. 09.468.15 □ 16

H.1000 mm.  
 Art. 09.468.16 □ 12  
 Art. 09.468.17 □ 14  
 Art. 09.468.18 □ 16

H.1200 mm.  
 Art. 09.468.19 □ 12  
 Art. 09.468.20 □ 14  
 Art. 09.468.21 □ 16

H.1500 mm.  
 Art. 09.468.22 □ 12  
 Art. 09.468.23 □ 14  
 Art. 09.468.24 □ 16



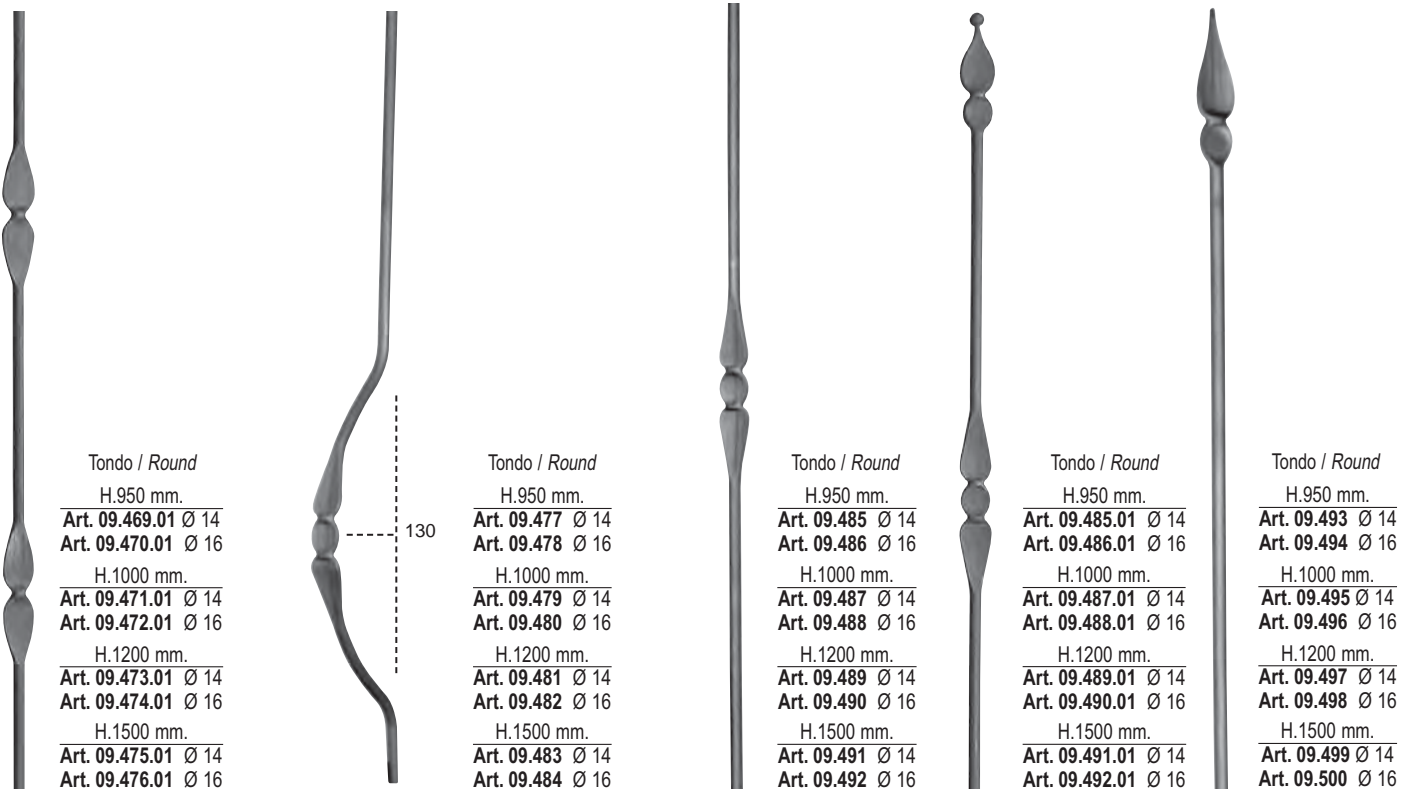
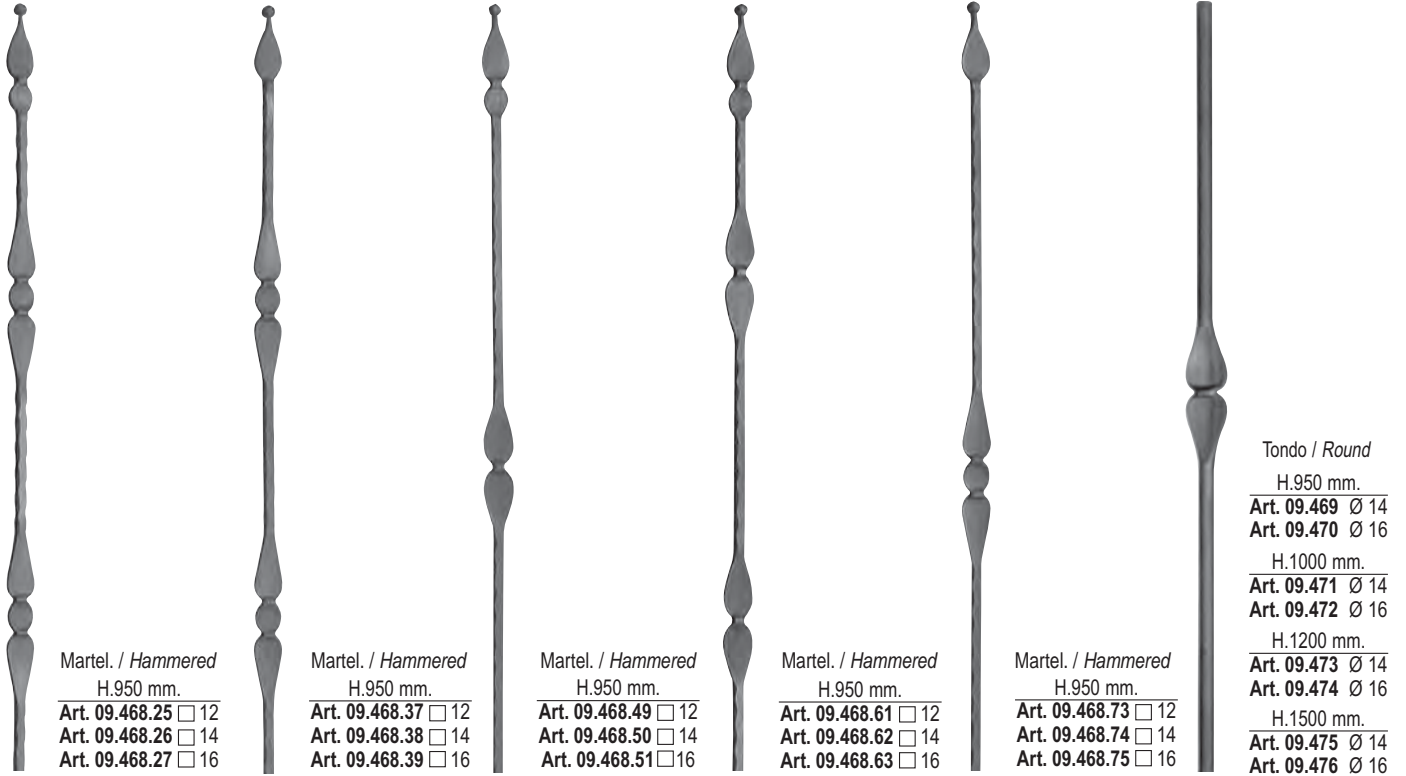

A RICHIESTA CON PALLINA SULLA LANCIA  
ON REQUEST WITH BALL ON THE SPEAR



Tondo / Round

H.950 mm.

Art. 09.493.01 Ø 14

Art. 09.494.01 Ø 16

H.1000 mm.

Art. 09.495.01 Ø 14

Art. 09.496.01 Ø 16

H.1200 mm.

Art. 09.497.01 Ø 14

Art. 09.498.01 Ø 16

H.1500 mm.

Art. 09.499.01 Ø 14

Art. 09.500.01 Ø 16



Fiamma grande / Big flame



Tondo / Round

H.950 mm.

Art. 09.500.20 Ø12

H.1000 mm.

Art. 09.500.23 Ø12

H.950 mm.

Art. 09.500.30 □ 12

H.1000 mm.

Art. 09.500.33 □ 12



Tondo / Round

H.950 mm.

Art. 09.501 Ø 14

Art. 09.502 Ø 16

H.1000 mm.

Art. 09.503 Ø 14

Art. 09.504 Ø 16

H.1200 mm.

Art. 09.505 Ø 14

Art. 09.506 Ø 16

H.1500 mm.

Art. 09.507 Ø 14

Art. 09.508 Ø 16



Tondo / Round

Borchia tornita / Turned stud  
H.950 mm.

Art. 09.509 Ø 14

Art. 09.509.01 Ø 12

Borchia stampata / Stamped stud  
H.950 mm.

Art. 09.509.02 Ø 14

Art. 09.509.03 Ø 12



550



Tondo / Round

Borchia tornita / Turned stud  
H.950 mm.

Art. 09.510 Ø 14

Art. 09.510.07 Ø 12

Borchia stampata / Stamped stud  
H.950 mm.

Art. 09.510.10 Ø 14

Art. 09.510.12 Ø 12



H.950 mm.

Art. 09.510.03 □ 14

Art. 09.510.05 □ 12



H.950 mm.

Art. 09.510.04 □ 14

Art. 09.510.06 □ 12



H.1500 mm.

Art. 09.510.08 □ 12

Art. 09.510.09 □ 14



H.2000 mm.

Art. 09.510.20 □ 12

Art. 09.510.21 □ 14

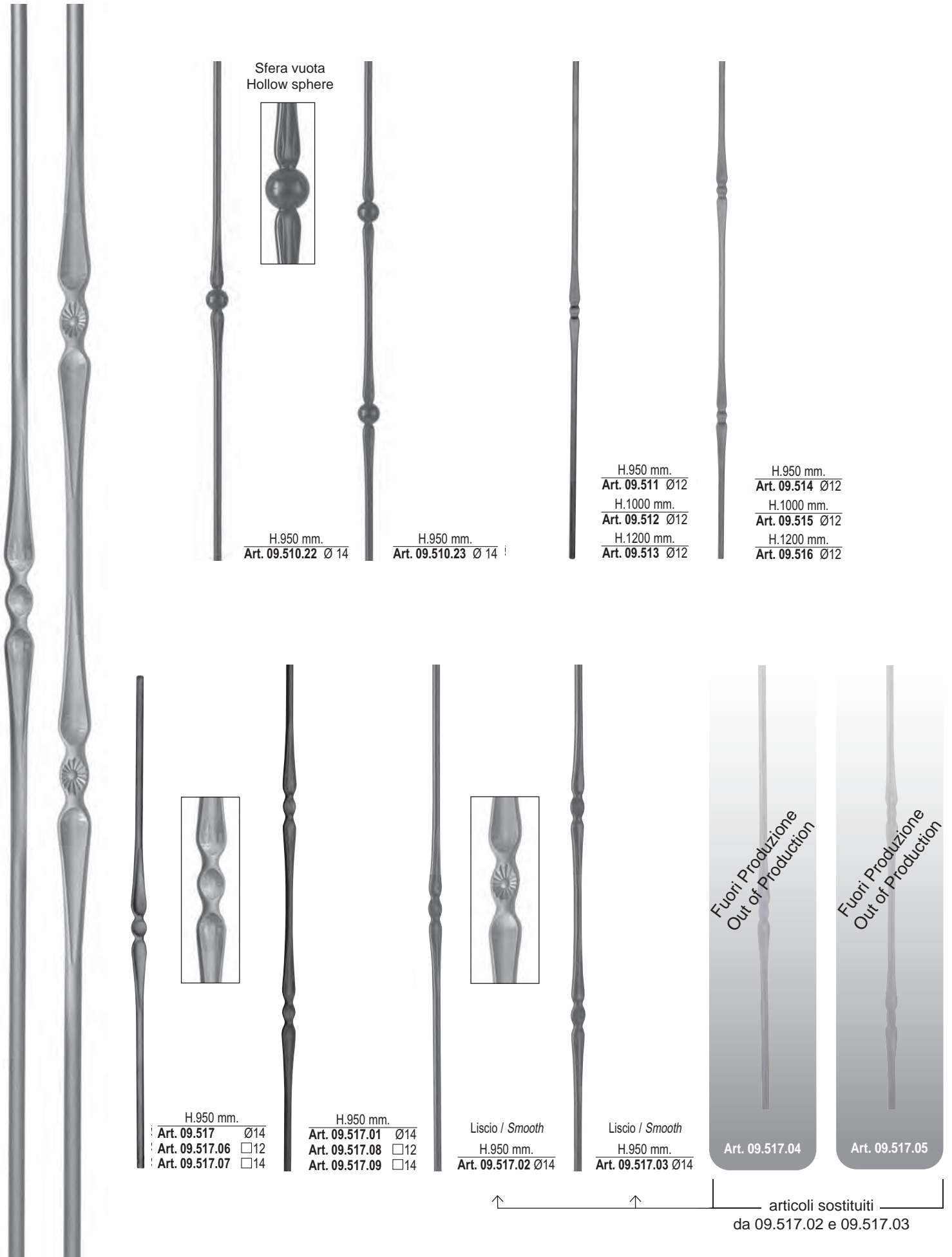

Sfera vuota  
Hollow sphere



H.950 mm.  
Art. 09.510.22 Ø 14

H.950 mm.  
Art. 09.510.23 Ø 14

H.950 mm.  
Art. 09.511 Ø12  
H.1000 mm.  
Art. 09.512 Ø12  
H.1200 mm.  
Art. 09.513 Ø12

H.950 mm.  
Art. 09.514 Ø12  
H.1000 mm.  
Art. 09.515 Ø12  
H.1200 mm.  
Art. 09.516 Ø12



H.950 mm.  
Art. 09.517 Ø14  
Art. 09.517.06 □12  
Art. 09.517.07 □14



H.950 mm.  
Art. 09.517.01 Ø14  
Art. 09.517.08 □12  
Art. 09.517.09 □14

Liscio / Smooth  
H.950 mm.  
Art. 09.517.02 Ø14

Liscio / Smooth  
H.950 mm.  
Art. 09.517.03 Ø14

Fuori Produzione  
Out of Production

Art. 09.517.04

Fuori Produzione  
Out of Production

Art. 09.517.05

↑ ↑ articoli sostituiti  
da 09.517.02 e 09.517.03





Martellato / Hammered

H.950 mm.  
Art. 09.518 □ 12  
Art. 09.519 □ 14  
Art. 09.520 □ 16  
H.1000 mm.  
Art. 09.521 □ 12  
Art. 09.522 □ 14  
Art. 09.523 □ 16  
H.1200 mm.  
Art. 09.524 □ 12  
Art. 09.525 □ 14  
Art. 09.526 □ 16



Martellato / Hammered

H.950 mm.  
Art. 09.518.01 □ 12  
Art. 09.519.01 □ 14  
Art. 09.520.01 □ 16  
H.1000 mm.  
Art. 09.521.01 □ 12  
Art. 09.522.01 □ 14  
Art. 09.523.01 □ 16  
H.1200 mm.  
Art. 09.524.01 □ 12  
Art. 09.525.01 □ 14  
Art. 09.526.01 □ 16



Martellato / Hammered

H.950 mm.  
Art. 09.527 □ 12  
Art. 09.528 □ 14  
Art. 09.529 □ 16  
H.1000 mm.  
Art. 09.530 □ 12  
Art. 09.531 □ 14  
Art. 09.532 □ 16  
H.1200 mm.  
Art. 09.533 □ 12  
Art. 09.534 □ 14  
Art. 09.535 □ 16



Martellato / Hammered

H.950 mm.  
Art. 09.536 □ 12  
Art. 09.537 □ 14  
Art. 09.538 □ 16  
H.1000 mm.  
Art. 09.539 □ 12  
Art. 09.540 □ 14  
Art. 09.541 □ 16  
H.1200 mm.  
Art. 09.542 □ 12  
Art. 09.543 □ 14  
Art. 09.544 □ 16



Martellato / Hammered

H.950 mm.  
Art. 09.536.01 □ 12  
Art. 09.537.01 □ 14  
Art. 09.538.01 □ 16



Martellato / Hammered

H.950 mm.  
Art. 09.545 □ 12  
Art. 09.546 □ 14  
Art. 09.547 □ 16  
H.1000 mm.  
Art. 09.548 □ 12  
Art. 09.549 □ 14  
Art. 09.550 □ 16  
H.1200 mm.  
Art. 09.551 □ 12  
Art. 09.552 □ 14  
Art. 09.553 □ 16



Martellato / Hammered

H.950 mm.  
Art. 09.545.01 □ 12  
Art. 09.546.01 □ 14  
Art. 09.547.01 □ 16



Martellato / Hammered

H.950 mm.  
Art. 09.554 □ 12  
Art. 09.555 □ 14  
Art. 09.556 □ 16  
H.1000 mm.  
Art. 09.557 □ 12  
Art. 09.558 □ 14  
Art. 09.559 □ 16  
H.1200 mm.  
Art. 09.560 □ 12  
Art. 09.561 □ 14  
Art. 09.562 □ 16



130

Martellato / Hammered

H.950 mm.  
Art. 09.563 □ 12  
Art. 09.564 □ 14  
Art. 09.565 □ 16  
H.1000 mm.  
Art. 09.566 □ 12  
Art. 09.567 □ 14  
Art. 09.568 □ 16  
H.1200 mm.  
Art. 09.569 □ 12  
Art. 09.570 □ 14  
Art. 09.571 □ 16



Martellato / Hammered

H.950 mm.  
Art. 09.572 □ 12  
Art. 09.573 □ 14  
Art. 09.574 □ 16  
H.1000 mm.  
Art. 09.575 □ 12  
Art. 09.576 □ 14  
Art. 09.577 □ 16  
H.1200 mm.  
Art. 09.578 □ 12  
Art. 09.579 □ 14  
Art. 09.580 □ 16



H.950 mm.  
Art. 09.581 □ 12  
Art. 09.582 □ 14  
Art. 09.583 □ 16  
H.1000 mm.  
Art. 09.584 □ 12  
Art. 09.585 □ 14  
Art. 09.586 □ 16  
H.1200 mm.  
Art. 09.587 □ 12  
Art. 09.588 □ 14  
Art. 09.589 □ 16

A RICHIESTA CON PALLINA SULLA LANCIA  
ON REQUEST WITH BALL ON THE SPEAR



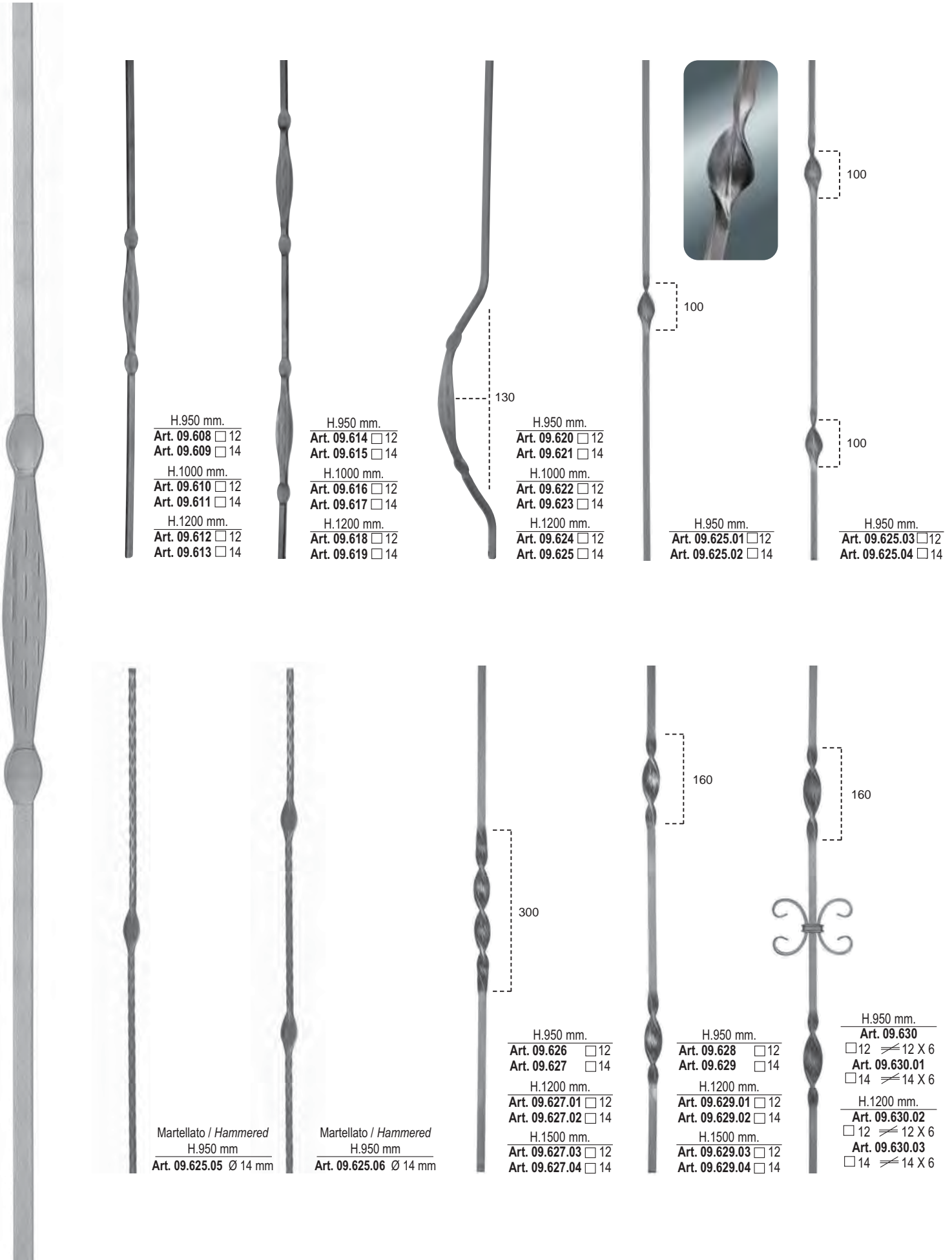

H.950 mm.  
Art. 09.608 □ 12  
Art. 09.609 □ 14

H.1000 mm.  
Art. 09.610 □ 12  
Art. 09.611 □ 14

H.1200 mm.  
Art. 09.612 □ 12  
Art. 09.613 □ 14

H.950 mm.  
Art. 09.614 □ 12  
Art. 09.615 □ 14

H.1000 mm.  
Art. 09.616 □ 12  
Art. 09.617 □ 14

H.1200 mm.  
Art. 09.618 □ 12  
Art. 09.619 □ 14

H.950 mm.  
Art. 09.620 □ 12  
Art. 09.621 □ 14

H.1000 mm.  
Art. 09.622 □ 12  
Art. 09.623 □ 14

H.1200 mm.  
Art. 09.624 □ 12  
Art. 09.625 □ 14

H.950 mm.  
Art. 09.625.01 □ 12  
Art. 09.625.02 □ 14

H.950 mm.  
Art. 09.625.03 □ 12  
Art. 09.625.04 □ 14

Martellato / Hammered  
H.950 mm  
Art. 09.625.05 Ø 14 mm

Martellato / Hammered  
H.950 mm  
Art. 09.625.06 Ø 14 mm

H.950 mm.  
Art. 09.626 □ 12  
Art. 09.627 □ 14

H.1200 mm.  
Art. 09.627.01 □ 12  
Art. 09.627.02 □ 14

H.1500 mm.  
Art. 09.627.03 □ 12  
Art. 09.627.04 □ 14

H.950 mm.  
Art. 09.628 □ 12  
Art. 09.629 □ 14

H.1200 mm.  
Art. 09.629.01 □ 12  
Art. 09.629.02 □ 14

H.1500 mm.  
Art. 09.629.03 □ 12  
Art. 09.629.04 □ 14

H.950 mm.  
Art. 09.630  
□ 12 ≙ 12 X 6  
Art. 09.630.01  
□ 14 ≙ 14 X 6

H.1200 mm.  
Art. 09.630.02  
□ 12 ≙ 12 X 6  
Art. 09.630.03  
□ 14 ≙ 14 X 6

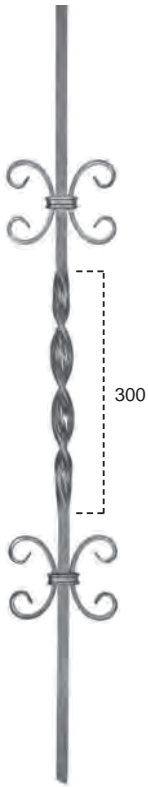

H.950 mm.  
**Art. 09.631**  
 12  $\neq$  12 X 6  
**Art. 09.631.01**  
 14  $\neq$  14 X 6

H.1200 mm.  
**Art. 09.631.02**  
 12  $\neq$  12 X 6  
**Art. 09.631.03**  
 14  $\neq$  14 X 6

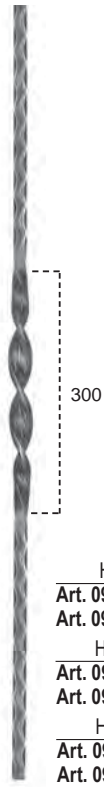

H.950 mm.  
**Art. 09.631.04**  12  
**Art. 09.631.05**  14

H.1200 mm.  
**Art. 09.631.06**  12  
**Art. 09.631.07**  14

H.1500 mm.  
**Art. 09.631.08**  12  
**Art. 09.631.09**  14



H.950 mm.  
**Art. 09.631.10**  12  
**Art. 09.631.11**  14

H.1200 mm.  
**Art. 09.631.12**  12  
**Art. 09.631.13**  14

H.1500 mm.  
**Art. 09.631.14**  12  
**Art. 09.631.15**  14



H.950 mm.  
**Art. 09.631.16**  
 12  $\neq$  12 X 6  
**Art. 09.631.17**  
 14  $\neq$  14 X 6

H.1200 mm.  
**Art. 09.631.18**  
 12  $\neq$  12 X 6  
**Art. 09.631.19**  
 14  $\neq$  14 X 6

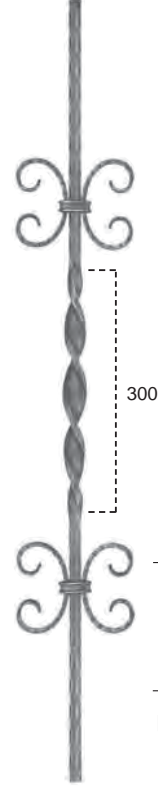

H.950 mm.  
**Art. 09.631.20**  
 12  $\neq$  12 X 6  
**Art. 09.631.21**  
 14  $\neq$  14 X 6

H.1200 mm.  
**Art. 09.631.22**  
 12  $\neq$  12 X 6  
**Art. 09.631.23**  
 14  $\neq$  14 X 6



*Martellato/Hammered*

H.950 mm.  
**Art. 09.632**  12  
**Art. 09.632.01**  14  
**Art. 09.632.02**  16

H.1200 mm.  
**Art. 09.632.03**  12  
**Art. 09.632.04**  14  
**Art. 09.632.05**  16

H.1500 mm.  
**Art. 09.632.06**  12  
**Art. 09.632.07**  14  
**Art. 09.632.08**  16

H.1800 mm.  
**Art. 09.632.09**  12  
**Art. 09.632.10**  14  
**Art. 09.632.11**  16

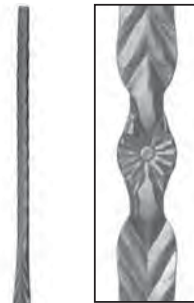

*Martellato/Hammered*

H.950 mm.  
**Art. 09.633**  12  
**Art. 09.633.01**  14  
**Art. 09.633.02**  16

H.1200 mm.  
**Art. 09.633.03**  12  
**Art. 09.633.04**  14  
**Art. 09.633.05**  16

H.1500 mm.  
**Art. 09.633.06**  12  
**Art. 09.633.07**  14  
**Art. 09.633.08**  16

H.1800 mm.  
**Art. 09.633.09**  12  
**Art. 09.633.10**  14  
**Art. 09.633.11**  16



H.950 mm.  
**Art. 09.633.12**  12  
**Art. 09.633.13**  14  
**Art. 09.633.14**  16

H.1200 mm.  
**Art. 09.633.15**  12  
**Art. 09.633.16**  14  
**Art. 09.633.17**  16

H.1500 mm.  
**Art. 09.633.18**  12  
**Art. 09.633.19**  14  
**Art. 09.633.20**  16

H.1800 mm.  
**Art. 09.633.21**  12  
**Art. 09.633.22**  14  
**Art. 09.633.23**  16



H.950 mm.  
**Art. 09.633.24**  12  
**Art. 09.633.25**  14  
**Art. 09.633.26**  16

H.1200 mm.  
**Art. 09.633.27**  12  
**Art. 09.633.28**  14  
**Art. 09.633.29**  16

H.1500 mm.  
**Art. 09.633.30**  12  
**Art. 09.633.31**  14  
**Art. 09.633.32**  16

H.1800 mm.  
**Art. 09.633.33**  12  
**Art. 09.633.34**  14  
**Art. 09.633.35**  16





Martellato/Hammered  
H.1000 X L.140 mm.  
Art. 09.634  12  
Art. 09.635  14



Martellato/Hammered  
H.1000 X L.140 mm.  
Art. 09.636  12  
Art. 09.637  14



Martellato/Hammered  
H.1000 X L.140 mm.  
Art. 09.638  12  
Art. 09.639  14



Martellato/Hammered  
H.950 mm.  
Art. 09.640  12  
Art. 09.641  14  
Art. 09.642  16  
H.1000 mm.  
Art. 09.643  12  
Art. 09.644  14  
Art. 09.645  16  
H.1200 mm.  
Art. 09.646  12  
Art. 09.647  14  
Art. 09.648  16

Paletti ricalcati / New forged bars



Martellato/Hammered  
H.950 mm.  
Art. 09.658  12  
Art. 09.659  14



Martellato/Hammered  
H.950 mm.  
Art. 09.660  12  
Art. 09.661  14



H.950 mm.  
Art. 09.662  12  
Art. 09.663  14



H.950 mm.  
Art. 09.664  12  
Art. 09.665  14



H.950 X L.200mm.  
Art. 09.666 Ø14



H.950 X L.200mm.  
Art. 09.667 Ø14



A RICHIESTA CON PALLINA SULLA LANCIA  
ON REQUEST WITH BALL ON THE SPEAR

Tutte le parti di questo catalogo - foto comprese - sono di proprietà Euro-Fer. La riproduzione, anche parziale, è vietata in ogni forma e con ogni mezzo. / Every part of this catalogue - photos included - is Euro-Fer's property. All forms of copying are strictly prohibited.



Martellato. / *Hammered*  
H. 950 X L. 130 mm.

Art. 09.668  12  
Art. 09.669  14  
Art. 09.669.01  16

H. 1200 X L. 130 mm.

Art. 09.669.02  12  
Art. 09.669.03  14  
Art. 09.669.04  16

H. 1500 X L. 130 mm.

Art. 09.669.05  12  
Art. 09.669.06  14  
Art. 09.669.07  16

H. 1800 X L. 130 mm.

Art. 09.669.08  12  
Art. 09.669.09  14  
Art. 09.669.10  16



H. 950 X L. 130 mm.  
Art. 09.671.01 Ø 14



H.950 mm.  
Art. 09.672  12  
Art. 09.673  14  
Art. 09.674  16



H.950 mm.  
Art. 09.684  12  
Art. 09.685  14  
Art. 09.686  16



H.950 mm.  
Art. 09.696  12  
Art. 09.697  14  
Art. 09.698  16



H.950 mm.  
Art. 09.708  12  
Art. 09.709  14  
Art. 09.710  16

H.1200 mm.  
Art. 09.711  12  
Art. 09.712  14  
Art. 09.713  16

H.1500 mm.  
Art. 09.714  12  
Art. 09.715  14  
Art. 09.716  16

H.1800 mm.  
Art. 09.717  12  
Art. 09.718  14  
Art. 09.719  16



Martel./ *Hammered*  
H.950 mm.  
Art. 09.720  12  
Art. 09.721  14  
Art. 09.722  16

H.1200 mm.  
Art. 09.723  12  
Art. 09.724  14  
Art. 09.725  16

H.1500 mm.  
Art. 09.726  12  
Art. 09.727  14  
Art. 09.728  16

H.1800 mm.  
Art. 09.729  12  
Art. 09.730  14  
Art. 09.731  16



H.950 mm.  
Art. 09.732 Ø 14  
Art. 09.733 Ø 16  
H.1200 mm.  
Art. 09.734 Ø 14  
Art. 09.735 Ø 16  
H.1500 mm.  
Art. 09.736 Ø 14  
Art. 09.737 Ø 16  
H.1800 mm.  
Art. 09.738 Ø 14  
Art. 09.739 Ø 16

Palline piccole / *Small Balls*



		H.950 mm.	H.950 mm.	H.950 mm.	H.950 mm.	H.950 mm.	H.950 mm.	H.950 mm.
		Art. 09.740 <input type="checkbox"/> 12	Art. 09.752 <input type="checkbox"/> 12	Art. 09.764 <input type="checkbox"/> 12	Art. 09.776 <input type="checkbox"/> 12	Art. 09.788 <input type="checkbox"/> 12	Art. 09.740 <input type="checkbox"/> 12	Art. 09.788 <input type="checkbox"/> 12
		Art. 09.741 <input type="checkbox"/> 14	Art. 09.753 <input type="checkbox"/> 14	Art. 09.765 <input type="checkbox"/> 14	Art. 09.777 <input type="checkbox"/> 14	Art. 09.789 <input type="checkbox"/> 14	Art. 09.741 <input type="checkbox"/> 14	Art. 09.789 <input type="checkbox"/> 14
		Art. 09.742 <input type="checkbox"/> 16	Art. 09.754 <input type="checkbox"/> 16	Art. 09.766 <input type="checkbox"/> 16	Art. 09.778 <input type="checkbox"/> 16	Art. 09.790 <input type="checkbox"/> 16	Art. 09.742 <input type="checkbox"/> 16	Art. 09.790 <input type="checkbox"/> 16
		H.1000 mm.	H.1000 mm.	H.1000 mm.	H.1000 mm.	H.1000 mm.	H.1000 mm.	H.1000 mm.
		Art. 09.743 <input type="checkbox"/> 12	Art. 09.755 <input type="checkbox"/> 12	Art. 09.767 <input type="checkbox"/> 12	Art. 09.779 <input type="checkbox"/> 12	Art. 09.791 <input type="checkbox"/> 12	Art. 09.743 <input type="checkbox"/> 12	Art. 09.791 <input type="checkbox"/> 12
		Art. 09.744 <input type="checkbox"/> 14	Art. 09.756 <input type="checkbox"/> 14	Art. 09.768 <input type="checkbox"/> 14	Art. 09.780 <input type="checkbox"/> 14	Art. 09.792 <input type="checkbox"/> 14	Art. 09.744 <input type="checkbox"/> 14	Art. 09.792 <input type="checkbox"/> 14
		Art. 09.745 <input type="checkbox"/> 16	Art. 09.757 <input type="checkbox"/> 16	Art. 09.769 <input type="checkbox"/> 16	Art. 09.781 <input type="checkbox"/> 16	Art. 09.793 <input type="checkbox"/> 16	Art. 09.745 <input type="checkbox"/> 16	Art. 09.793 <input type="checkbox"/> 16
		H.1200 mm.	H.1200 mm.	H.1200 mm.	H.1200 mm.	H.1200 mm.	H.1200 mm.	H.1200 mm.
		Art. 09.746 <input type="checkbox"/> 12	Art. 09.758 <input type="checkbox"/> 12	Art. 09.770 <input type="checkbox"/> 12	Art. 09.782 <input type="checkbox"/> 12	Art. 09.794 <input type="checkbox"/> 12	Art. 09.746 <input type="checkbox"/> 12	Art. 09.794 <input type="checkbox"/> 12
		Art. 09.747 <input type="checkbox"/> 14	Art. 09.759 <input type="checkbox"/> 14	Art. 09.771 <input type="checkbox"/> 14	Art. 09.783 <input type="checkbox"/> 14	Art. 09.795 <input type="checkbox"/> 14	Art. 09.747 <input type="checkbox"/> 14	Art. 09.795 <input type="checkbox"/> 14
		Art. 09.748 <input type="checkbox"/> 16	Art. 09.760 <input type="checkbox"/> 16	Art. 09.772 <input type="checkbox"/> 16	Art. 09.784 <input type="checkbox"/> 16	Art. 09.796 <input type="checkbox"/> 16	Art. 09.748 <input type="checkbox"/> 16	Art. 09.796 <input type="checkbox"/> 16
		H.1500 mm.	H.1500 mm.	H.1500 mm.	H.1500 mm.	H.1500 mm.	H.1500 mm.	H.1500 mm.
		Art. 09.749 <input type="checkbox"/> 12	Art. 09.761 <input type="checkbox"/> 12	Art. 09.773 <input type="checkbox"/> 12	Art. 09.785 <input type="checkbox"/> 12	Art. 09.797 <input type="checkbox"/> 12	Art. 09.749 <input type="checkbox"/> 12	Art. 09.797 <input type="checkbox"/> 12
		Art. 09.750 <input type="checkbox"/> 14	Art. 09.762 <input type="checkbox"/> 14	Art. 09.774 <input type="checkbox"/> 14	Art. 09.786 <input type="checkbox"/> 14	Art. 09.798 <input type="checkbox"/> 14	Art. 09.750 <input type="checkbox"/> 14	Art. 09.798 <input type="checkbox"/> 14
		Art. 09.751 <input type="checkbox"/> 16	Art. 09.763 <input type="checkbox"/> 16	Art. 09.775 <input type="checkbox"/> 16	Art. 09.787 <input type="checkbox"/> 16	Art. 09.799 <input type="checkbox"/> 16	Art. 09.751 <input type="checkbox"/> 16	Art. 09.799 <input type="checkbox"/> 16
		H.950 mm.	H.950 mm.	H.950 mm.	H.950 mm.	H.950 mm.	H.950 mm.	H.950 mm.
		Art. 09.800 <input type="checkbox"/> 12	Art. 09.812 <input type="checkbox"/> 12	Art. 09.824 <input type="checkbox"/> 12	Art. 09.836 <input type="checkbox"/> 12	Art. 09.848 <input type="checkbox"/> 12	Art. 09.800 <input type="checkbox"/> 12	Art. 09.848 <input type="checkbox"/> 12
		Art. 09.801 <input type="checkbox"/> 14	Art. 09.813 <input type="checkbox"/> 14	Art. 09.825 <input type="checkbox"/> 14	Art. 09.837 <input type="checkbox"/> 14	Art. 09.849 <input type="checkbox"/> 14	Art. 09.801 <input type="checkbox"/> 14	Art. 09.849 <input type="checkbox"/> 14
		Art. 09.802 <input type="checkbox"/> 16	Art. 09.814 <input type="checkbox"/> 16	Art. 09.826 <input type="checkbox"/> 16	Art. 09.838 <input type="checkbox"/> 16	Art. 09.850 <input type="checkbox"/> 16	Art. 09.802 <input type="checkbox"/> 16	Art. 09.850 <input type="checkbox"/> 16
		H.1000 mm.	H.1000 mm.	H.1000 mm.	H.1000 mm.	H.1000 mm.	H.1000 mm.	H.1000 mm.
		Art. 09.803 <input type="checkbox"/> 12	Art. 09.815 <input type="checkbox"/> 12	Art. 09.827 <input type="checkbox"/> 12	Art. 09.839 <input type="checkbox"/> 12	Art. 09.851 <input type="checkbox"/> 12	Art. 09.803 <input type="checkbox"/> 12	Art. 09.851 <input type="checkbox"/> 12
		Art. 09.804 <input type="checkbox"/> 14	Art. 09.816 <input type="checkbox"/> 14	Art. 09.828 <input type="checkbox"/> 14	Art. 09.840 <input type="checkbox"/> 14	Art. 09.852 <input type="checkbox"/> 14	Art. 09.804 <input type="checkbox"/> 14	Art. 09.852 <input type="checkbox"/> 14
		Art. 09.805 <input type="checkbox"/> 16	Art. 09.817 <input type="checkbox"/> 16	Art. 09.829 <input type="checkbox"/> 16	Art. 09.841 <input type="checkbox"/> 16	Art. 09.853 <input type="checkbox"/> 16	Art. 09.805 <input type="checkbox"/> 16	Art. 09.853 <input type="checkbox"/> 16
		H.1200 mm.	H.1200 mm.	H.1200 mm.	H.1200 mm.	H.1200 mm.	H.1200 mm.	H.1200 mm.
		Art. 09.806 <input type="checkbox"/> 12	Art. 09.818 <input type="checkbox"/> 12	Art. 09.830 <input type="checkbox"/> 12	Art. 09.842 <input type="checkbox"/> 12	Art. 09.854 <input type="checkbox"/> 12	Art. 09.806 <input type="checkbox"/> 12	Art. 09.854 <input type="checkbox"/> 12
		Art. 09.807 <input type="checkbox"/> 14	Art. 09.819 <input type="checkbox"/> 14	Art. 09.831 <input type="checkbox"/> 14	Art. 09.843 <input type="checkbox"/> 14	Art. 09.855 <input type="checkbox"/> 14	Art. 09.807 <input type="checkbox"/> 14	Art. 09.855 <input type="checkbox"/> 14
		Art. 09.808 <input type="checkbox"/> 16	Art. 09.820 <input type="checkbox"/> 16	Art. 09.832 <input type="checkbox"/> 16	Art. 09.844 <input type="checkbox"/> 16	Art. 09.856 <input type="checkbox"/> 16	Art. 09.808 <input type="checkbox"/> 16	Art. 09.856 <input type="checkbox"/> 16
		H.1500 mm.	H.1500 mm.	H.1500 mm.	H.1500 mm.	H.1500 mm.	H.1500 mm.	H.1500 mm.
		Art. 09.809 <input type="checkbox"/> 12	Art. 09.821 <input type="checkbox"/> 12	Art. 09.833 <input type="checkbox"/> 12	Art. 09.845 <input type="checkbox"/> 12	Art. 09.857 <input type="checkbox"/> 12	Art. 09.809 <input type="checkbox"/> 12	Art. 09.857 <input type="checkbox"/> 12
		Art. 09.810 <input type="checkbox"/> 14	Art. 09.822 <input type="checkbox"/> 14	Art. 09.834 <input type="checkbox"/> 14	Art. 09.846 <input type="checkbox"/> 14	Art. 09.858 <input type="checkbox"/> 14	Art. 09.810 <input type="checkbox"/> 14	Art. 09.858 <input type="checkbox"/> 14
		Art. 09.811 <input type="checkbox"/> 16	Art. 09.823 <input type="checkbox"/> 16	Art. 09.835 <input type="checkbox"/> 16	Art. 09.847 <input type="checkbox"/> 16	Art. 09.859 <input type="checkbox"/> 16	Art. 09.811 <input type="checkbox"/> 16	Art. 09.859 <input type="checkbox"/> 16



A RICHIESTA CON PALLINA SULLA LANCIA  
ON REQUEST WITH BALL ON THE SPEAR



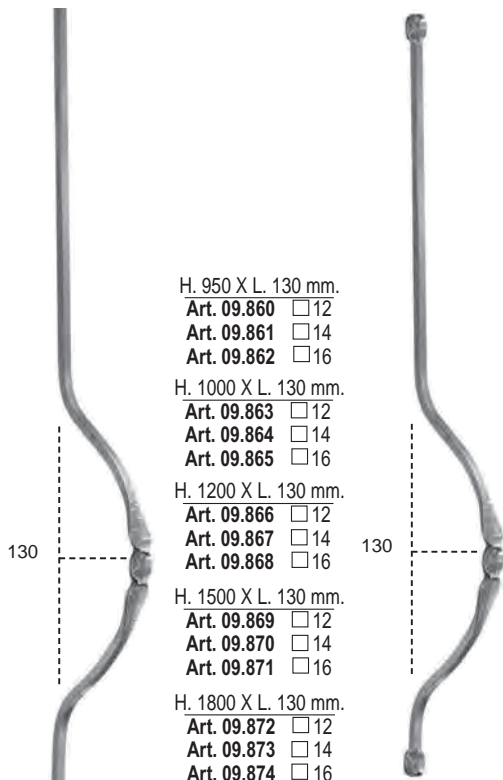

H. 950 X L. 130 mm.  
**Art. 09.860** □12  
**Art. 09.861** □14  
**Art. 09.862** □16  
 H. 1000 X L. 130 mm.  
**Art. 09.863** □12  
**Art. 09.864** □14  
**Art. 09.865** □16  
 H. 1200 X L. 130 mm.  
**Art. 09.866** □12  
**Art. 09.867** □14  
**Art. 09.868** □16  
 H. 1500 X L. 130 mm.  
**Art. 09.869** □12  
**Art. 09.870** □14  
**Art. 09.871** □16  
 H. 1800 X L. 130 mm.  
**Art. 09.872** □12  
**Art. 09.873** □14  
**Art. 09.874** □16

H. 950 X L. 130 mm.  
**Art. 09.875** □12  
**Art. 09.876** □14  
**Art. 09.877** □16  
 H. 1000 X L. 130 mm.  
**Art. 09.878** □12  
**Art. 09.879** □14  
**Art. 09.880** □16  
 H. 1200 X L. 130 mm.  
**Art. 09.881** □12  
**Art. 09.882** □14  
**Art. 09.883** □16  
 H. 1500 X L. 130 mm.  
**Art. 09.884** □12  
**Art. 09.885** □14  
**Art. 09.886** □16  
 H. 1800 X L. 130 mm.  
**Art. 09.887** □12  
**Art. 09.888** □14  
**Art. 09.889** □16

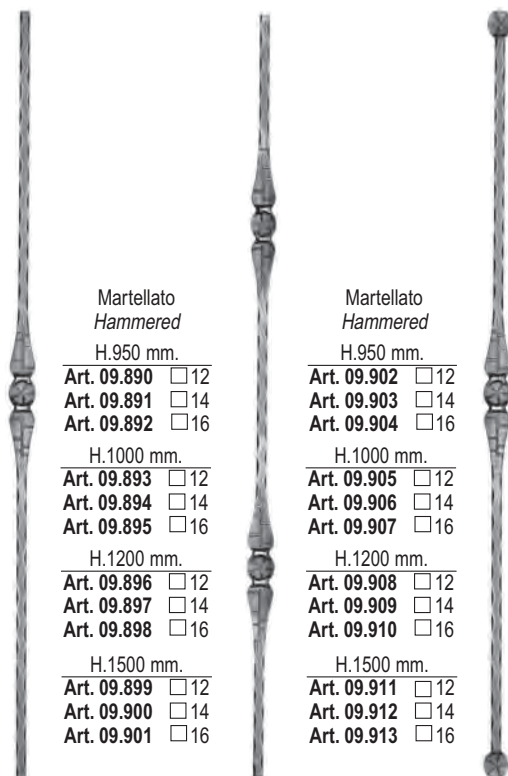

Martellato  
Hammered  
H.950 mm.  
**Art. 09.890** □12  
**Art. 09.891** □14  
**Art. 09.892** □16  
 H.1000 mm.  
**Art. 09.893** □12  
**Art. 09.894** □14  
**Art. 09.895** □16  
 H.1200 mm.  
**Art. 09.896** □12  
**Art. 09.897** □14  
**Art. 09.898** □16  
 H.1500 mm.  
**Art. 09.899** □12  
**Art. 09.900** □14  
**Art. 09.901** □16

Martellato  
Hammered  
H.950 mm.  
**Art. 09.902** □12  
**Art. 09.903** □14  
**Art. 09.904** □16  
 H.1000 mm.  
**Art. 09.905** □12  
**Art. 09.906** □14  
**Art. 09.907** □16  
 H.1200 mm.  
**Art. 09.908** □12  
**Art. 09.909** □14  
**Art. 09.910** □16  
 H.1500 mm.  
**Art. 09.911** □12  
**Art. 09.912** □14  
**Art. 09.913** □16

Martellato  
Hammered  
H.950 mm.  
**Art. 09.914** □12  
**Art. 09.915** □14  
**Art. 09.916** □16  
 H.1000 mm.  
**Art. 09.917** □12  
**Art. 09.918** □14  
**Art. 09.919** □16  
 H.1200 mm.  
**Art. 09.920** □12  
**Art. 09.921** □14  
**Art. 09.922** □16  
 H.1500 mm.  
**Art. 09.923** □12  
**Art. 09.924** □14  
**Art. 09.925** □16

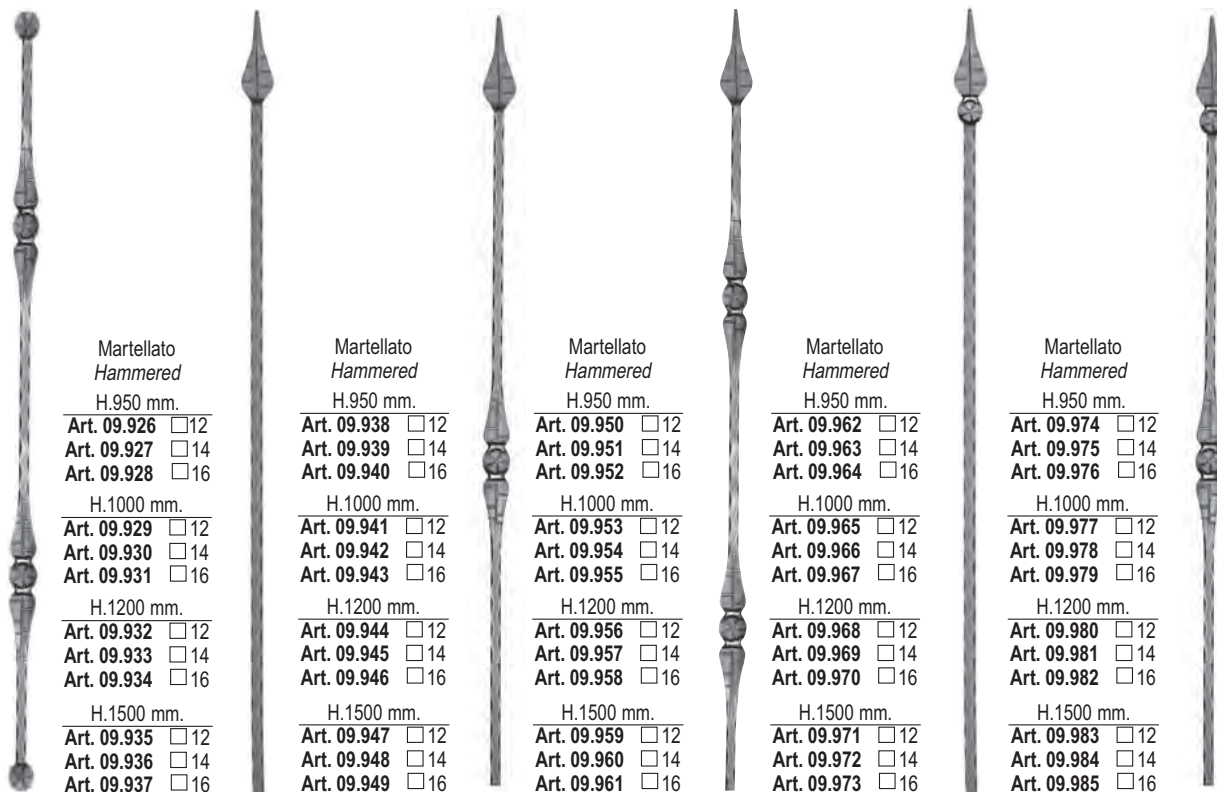

Martellato  
Hammered  
H.950 mm.  
**Art. 09.926** □12  
**Art. 09.927** □14  
**Art. 09.928** □16  
 H.1000 mm.  
**Art. 09.929** □12  
**Art. 09.930** □14  
**Art. 09.931** □16  
 H.1200 mm.  
**Art. 09.932** □12  
**Art. 09.933** □14  
**Art. 09.934** □16  
 H.1500 mm.  
**Art. 09.935** □12  
**Art. 09.936** □14  
**Art. 09.937** □16

Martellato  
Hammered  
H.950 mm.  
**Art. 09.938** □12  
**Art. 09.939** □14  
**Art. 09.940** □16  
 H.1000 mm.  
**Art. 09.941** □12  
**Art. 09.942** □14  
**Art. 09.943** □16  
 H.1200 mm.  
**Art. 09.944** □12  
**Art. 09.945** □14  
**Art. 09.946** □16  
 H.1500 mm.  
**Art. 09.947** □12  
**Art. 09.948** □14  
**Art. 09.949** □16

Martellato  
Hammered  
H.950 mm.  
**Art. 09.950** □12  
**Art. 09.951** □14  
**Art. 09.952** □16  
 H.1000 mm.  
**Art. 09.953** □12  
**Art. 09.954** □14  
**Art. 09.955** □16  
 H.1200 mm.  
**Art. 09.956** □12  
**Art. 09.957** □14  
**Art. 09.958** □16  
 H.1500 mm.  
**Art. 09.959** □12  
**Art. 09.960** □14  
**Art. 09.961** □16

Martellato  
Hammered  
H.950 mm.  
**Art. 09.962** □12  
**Art. 09.963** □14  
**Art. 09.964** □16  
 H.1000 mm.  
**Art. 09.965** □12  
**Art. 09.966** □14  
**Art. 09.967** □16  
 H.1200 mm.  
**Art. 09.968** □12  
**Art. 09.969** □14  
**Art. 09.970** □16  
 H.1500 mm.  
**Art. 09.971** □12  
**Art. 09.972** □14  
**Art. 09.973** □16

Martellato  
Hammered  
H.950 mm.  
**Art. 09.974** □12  
**Art. 09.975** □14  
**Art. 09.976** □16  
 H.1000 mm.  
**Art. 09.977** □12  
**Art. 09.978** □14  
**Art. 09.979** □16  
 H.1200 mm.  
**Art. 09.980** □12  
**Art. 09.981** □14  
**Art. 09.982** □16  
 H.1500 mm.  
**Art. 09.983** □12  
**Art. 09.984** □14  
**Art. 09.985** □16

Martellato  
Hammered  
H.950 mm.  
**Art. 09.986** □12  
**Art. 09.987** □14  
**Art. 09.988** □16  
 H.1000 mm.  
**Art. 09.989** □12  
**Art. 09.990** □14  
**Art. 09.991** □16  
 H.1200 mm.  
**Art. 09.992** □12  
**Art. 09.993** □14  
**Art. 09.994** □16  
 H.1500 mm.  
**Art. 09.995** □12  
**Art. 09.996** □14  
**Art. 09.997** □16

A RICHIESTA CON PALLINA SULLA LANCIA  
ON REQUEST WITH BALL ON THE SPEAR





Martellato  
Hammered

H.950 mm.  
Art. 09.998  12  
Art. 09.999  14  
Art. 09.999.01  16

H.1000 mm.  
Art. 09.999.02  12  
Art. 09.999.03  14  
Art. 09.999.04  16

H.1200 mm.  
Art. 09.999.05  12  
Art. 09.999.06  14  
Art. 09.999.07  16

H.1500 mm.  
Art. 09.999.08  12  
Art. 09.999.09  14  
Art. 09.999.10  16



Martellato  
Hammered

H.950 mm.  
Art. 09.999.11  12  
Art. 09.999.12  14  
Art. 09.999.13  16

H.1000 mm.  
Art. 09.999.14  12  
Art. 09.999.15  14  
Art. 09.999.16  16

H.1200 mm.  
Art. 09.999.17  12  
Art. 09.999.18  14  
Art. 09.999.19  16

H.1500 mm.  
Art. 09.999.20  12  
Art. 09.999.21  14  
Art. 09.999.22  16

H.1800 mm.  
Art. 09.999.23  12  
Art. 09.999.24  14  
Art. 09.999.25  16



Martellato  
Hammered

H.950 mm.  
Art. 09.999.26  12  
Art. 09.999.27  14  
Art. 09.999.28  16

H.1000 mm.  
Art. 09.999.29  12  
Art. 09.999.30  14  
Art. 09.999.31  16

H.1200 mm.  
Art. 09.999.32  12  
Art. 09.999.33  14  
Art. 09.999.34  16

H.1500 mm.  
Art. 09.999.35  12  
Art. 09.999.36  14  
Art. 09.999.37  16

H.1800 mm.  
Art. 09.999.38  12  
Art. 09.999.39  14  
Art. 09.999.40  16



Martellato/Hammered

H.950 mm.  
Art. 09.1002.01  12  
Art. 09.1002.02  14  
Art. 09.1002.03  16

H.1000 mm.  
Art. 09.1002.04  12  
Art. 09.1002.05  14  
Art. 09.1002.06  16

H.1200 mm.  
Art. 09.1002.07  12  
Art. 09.1002.08  14  
Art. 09.1002.09  16

H.1500 mm.  
Art. 09.1002.10  12  
Art. 09.1002.11  14  
Art. 09.1002.12  16



Liscio / Smooth

H.950 mm.  
Art. 09.1003  14  
Art. 09.1003.01  16

H.1000 mm.  
Art. 09.1003.02  14  
Art. 09.1003.03  16

H.1200 mm.  
Art. 09.1003.04  14  
Art. 09.1003.05  16

H.1500 mm.  
Art. 09.1003.06  14  
Art. 09.1003.07  16



Liscio / Smooth

H.950 mm.  
Art. 09.1004  12  
Art. 09.1004.01  14  
Art. 09.1004.02  16

H.1000 mm.  
Art. 09.1004.03  12  
Art. 09.1004.04  14  
Art. 09.1004.05  16

H.1200 mm.  
Art. 09.1004.06  12  
Art. 09.1004.07  14  
Art. 09.1004.08  16

H.1500 mm.  
Art. 09.1004.09  12  
Art. 09.1004.10  14  
Art. 09.1004.11  16



Liscio / Smooth

H.950 mm.  
Art. 09.1005  12  
Art. 09.1005.01  14  
Art. 09.1005.02  16

H.1000 mm.  
Art. 09.1005.03  12  
Art. 09.1005.04  14  
Art. 09.1005.05  16

H.1200 mm.  
Art. 09.1005.06  12  
Art. 09.1005.07  14  
Art. 09.1005.08  16

H.1500 mm.  
Art. 09.1005.09  12  
Art. 09.1005.10  14  
Art. 09.1005.11  16



Martellato/Hammered

H.950 mm.  
Art. 09.1006  12  
Art. 09.1006.01  14  
Art. 09.1006.02  16

H.1000 mm.  
Art. 09.1006.03  12  
Art. 09.1006.04  14  
Art. 09.1006.05  16

H.1200 mm.  
Art. 09.1006.06  12  
Art. 09.1006.07  14  
Art. 09.1006.08  16

H.1500 mm.  
Art. 09.1006.09  12  
Art. 09.1006.10  14  
Art. 09.1006.11  16



A RICHIESTA CON PALLINA SULLA LANCIA  
ON REQUEST WITH BALL ON THE SPEAR



Liscio / Smooth  
H.950 mm.  
Art. 09.1007 Ø 12  
Art. 09.1007.01 Ø 14

H.1000 mm.  
Art. 09.1007.02 Ø 12  
Art. 09.1007.03 Ø 14

H.1200 mm.  
Art. 09.1007.04 Ø 12  
Art. 09.1007.05 Ø 14

H.1500 mm.  
Art. 09.1007.06 Ø 12  
Art. 09.1007.07 Ø 14



Liscio / Smooth  
H.950 mm.  
Art. 09.1008 □ 12

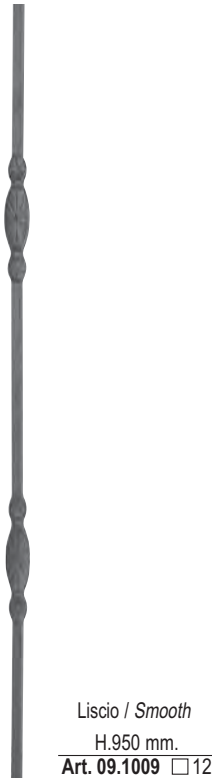

Liscio / Smooth  
H.950 mm.  
Art. 09.1009 □ 12



Martellato / Hammered  
H.950 mm.  
Art. 09.1010 □ 12



Martellato / Hammered  
H.950 mm.  
Art. 09.1011 □ 12

Fuori Produzione  
Out of Production

Art. 09.1012



Liscio / Smooth  
H.950 X L.100 mm.  
Art. 09.1013 Ø 12  
Art. 09.1013.01 Ø 14  
H.950 X L.150 mm.  
Art. 09.1013.02 Ø 12  
Art. 09.1013.03 Ø 14

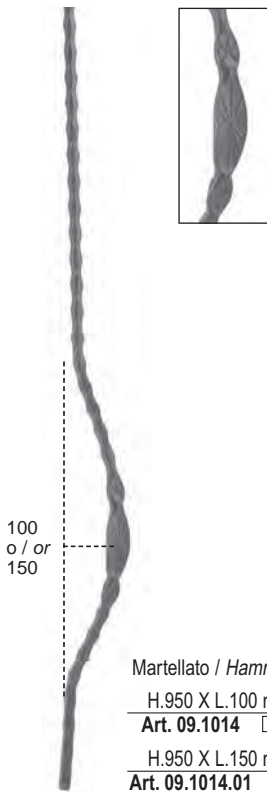

Martellato / Hammered  
H.950 X L.100 mm.  
Art. 09.1014 □ 14  
H.950 X L.150 mm.  
Art. 09.1014.01 □ 14

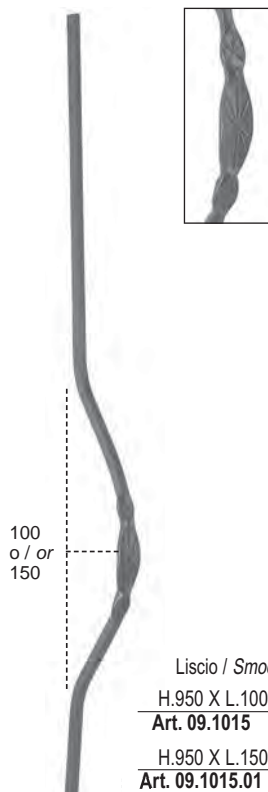

Liscio / Smooth  
H.950 X L.100 mm.  
Art. 09.1015 □ 14  
H.950 X L.150 mm.  
Art. 09.1015.01 □ 14





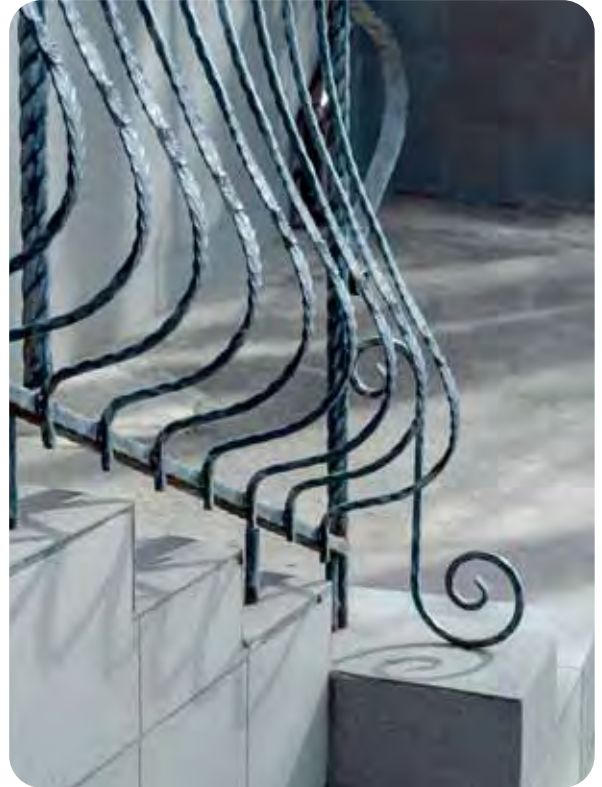
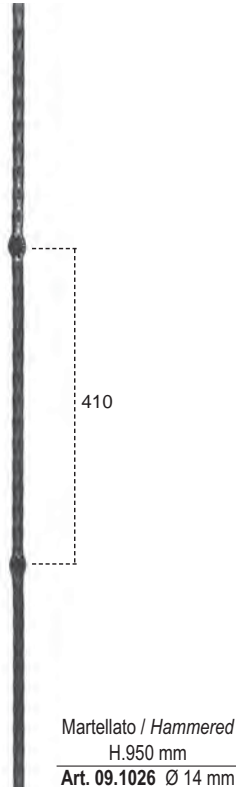
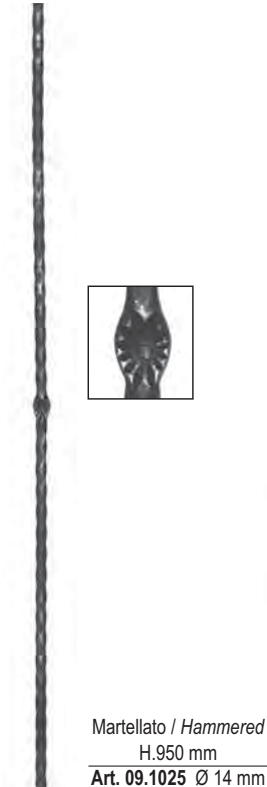
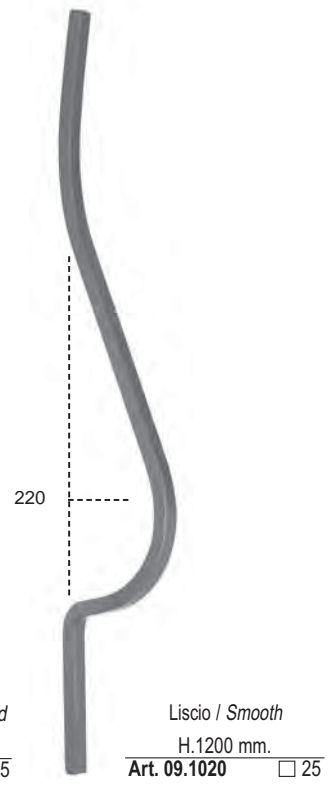
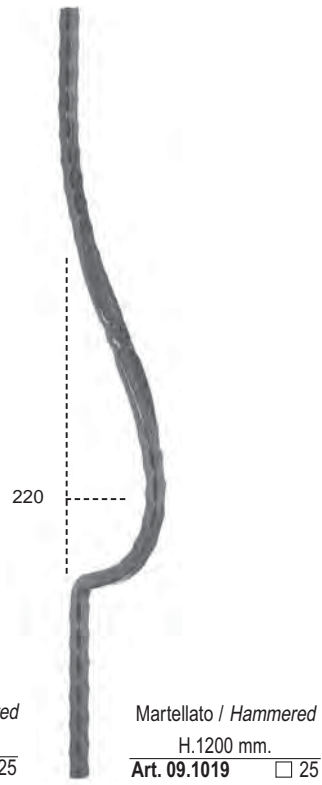
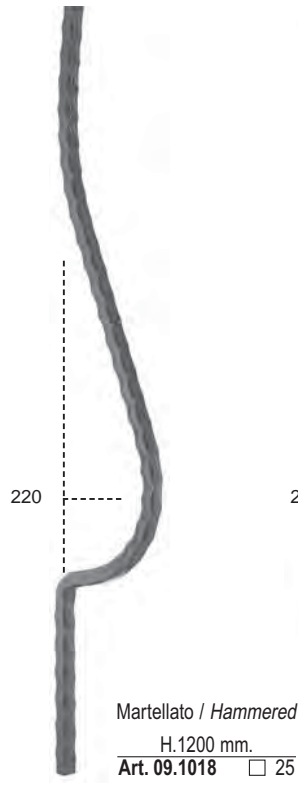
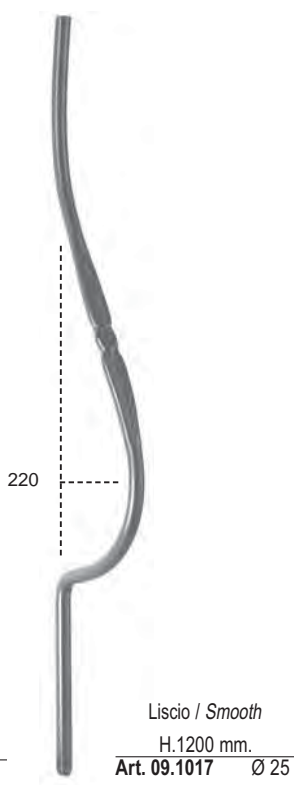
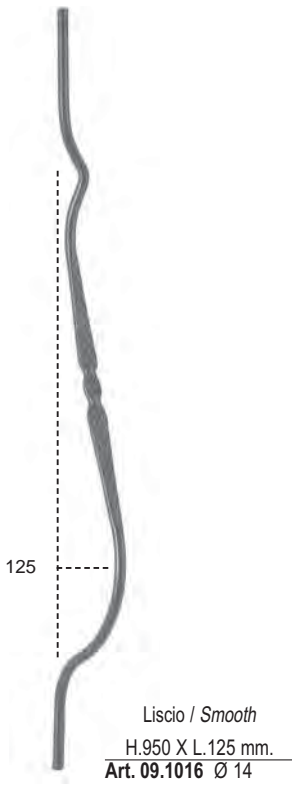



Schiacciata sullo spigolo /  
Ornament on the edge  
Liscio / Smooth

H 950 mm

- Art. 09.1050  12x12 mm  
Art. 09.1051  14x14 mm  
Art. 09.1052  16x16 mm

H 1000 mm

- Art. 09.1053  12x12 mm  
Art. 09.1054  14x14 mm  
Art. 09.1055  16x16 mm

H 1200 mm

- Art. 09.1056  12x12 mm  
Art. 09.1057  14x14 mm  
Art. 09.1058  16x16 mm



Schiacciata sullo spigolo /  
Ornament on the edge  
Liscio / Smooth

H 950 mm

- Art. 09.1059  12x12 mm  
Art. 09.1060  14x14 mm  
Art. 09.1061  16x16 mm

H 1000 mm

- Art. 09.1062  12x12 mm  
Art. 09.1063  14x14 mm  
Art. 09.1064  16x16 mm

H 1200 mm

- Art. 09.1065  12x12 mm  
Art. 09.1066  14x14 mm  
Art. 09.1067  16x16 mm



Schiacciata sullo spigolo /  
Ornament on the edge  
Martellato / Hammered

H 950 mm

- Art. 09.1068  12x12 mm  
Art. 09.1069  14x14 mm  
Art. 09.1070  16x16 mm

H 1000 mm

- Art. 09.1071  12x12 mm  
Art. 09.1072  14x14 mm  
Art. 09.1073  16x16 mm

H 1200 mm

- Art. 09.1074  12x12 mm  
Art. 09.1075  14x14 mm  
Art. 09.1076  16x16 mm



Schiacciata sullo spigolo /  
Ornament on the edge  
Martellato / Hammered

H 950 mm

- Art. 09.1077  12x12 mm  
Art. 09.1078  14x14 mm  
Art. 09.1079  16x16 mm

H 1000 mm

- Art. 09.1080  12x12 mm  
Art. 09.1081  14x14 mm  
Art. 09.1082  16x16 mm

H 1200 mm

- Art. 09.1083  12x12 mm  
Art. 09.1084  14x14 mm  
Art. 09.1085  16x16 mm



ELEMENTI IN FERRO RICALCATO  
NEW FORGED BARS

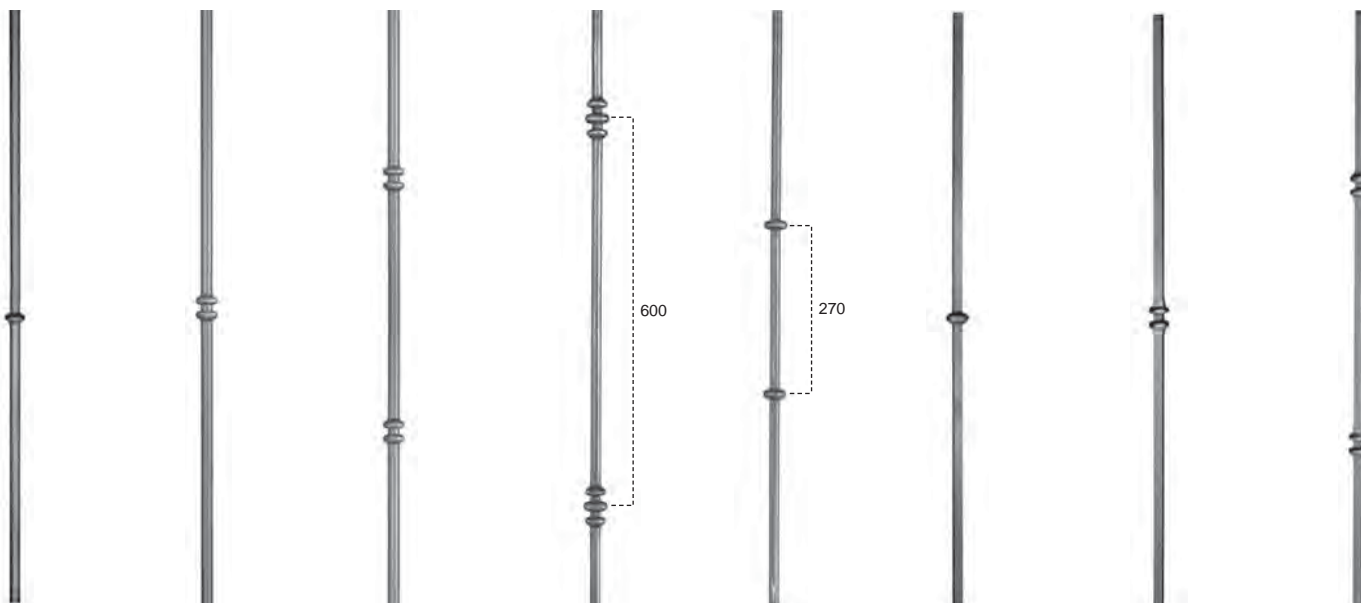

Tondo / Round		Tondo / Round		Tondo / Round		Tondo / Round		Tondo / Round		Tondo / Round		Tondo / Round		Tondo / Round	
H.950 mm.		H.950 mm.		H.950 mm.		H.1500 mm.		H.950 mm.		H.950 mm.		H.950 mm.		H.950 mm.	
Art. 10.001	Ø 16	Art. 10.005	Ø 16	Art. 10.009	Ø 16	Art. 10.012.03	Ø 12	Art. 10.012.09	Ø 12	Art. 10.013	□ 14	Art. 10.017	□ 14	Art. 10.021	□ 14
Art. 10.001.01	Ø 14	Art. 10.005.01	Ø 14	Art. 10.009.01	Ø 14	Art. 10.012.04	Ø 14	Art. 10.012.10	Ø 14	Art. 10.013.01	□ 16	Art. 10.017.01	□ 16	Art. 10.021.01	□ 16
Art. 10.001.02	Ø 12	Art. 10.005.02	Ø 12	Art. 10.009.02	Ø 12	Art. 10.012.05	Ø 16	Art. 10.012.11	Ø 16	Art. 10.013.02	□ 12	Art. 10.017.02	□ 12	Art. 10.021.02	□ 12
H.1000 mm.		H.1000 mm.		H.1000 mm.		H.1800 mm.		H.950 mm.		H.1000 mm.		H.1000 mm.		H.1000 mm.	
Art. 10.002	Ø 16	Art. 10.006	Ø 16	Art. 10.010	Ø 16	Art. 10.012.06	Ø 12	Art. 10.014	□ 14	Art. 10.014	□ 14	Art. 10.018	□ 14	Art. 10.022	□ 14
Art. 10.002.01	Ø 14	Art. 10.006.01	Ø 14	Art. 10.010.01	Ø 14	Art. 10.012.07	Ø 14	Art. 10.014.01	□ 16	Art. 10.014.01	□ 16	Art. 10.018.01	□ 16	Art. 10.022.01	□ 16
Art. 10.002.02	Ø 12	Art. 10.006.02	Ø 12	Art. 10.010.02	Ø 12	Art. 10.012.08	Ø 16	Art. 10.014.02	□ 12	Art. 10.014.02	□ 12	Art. 10.018.02	□ 12	Art. 10.022.02	□ 12
H.1200 mm.		H.1200 mm.		H.1200 mm.				H.1200 mm.		H.1200 mm.		H.1200 mm.		H.1200 mm.	
Art. 10.003	Ø 16	Art. 10.007	Ø 16	Art. 10.011	Ø 16			Art. 10.015	□ 14	Art. 10.015	□ 14	Art. 10.019	□ 14	Art. 10.023	□ 14
Art. 10.003.01	Ø 14	Art. 10.007.01	Ø 14	Art. 10.011.01	Ø 14			Art. 10.015.01	□ 16	Art. 10.015.01	□ 16	Art. 10.019.01	□ 16	Art. 10.023.01	□ 16
Art. 10.003.02	Ø 12	Art. 10.007.02	Ø 12	Art. 10.011.02	Ø 12			Art. 10.015.02	□ 12	Art. 10.015.02	□ 12	Art. 10.019.02	□ 12	Art. 10.023.02	□ 12
H.1500 mm.		H.1500 mm.		H.1500 mm.				H.1500 mm.		H.1500 mm.		H.1500 mm.		H.1500 mm.	
Art. 10.004	Ø 16	Art. 10.008	Ø 16	Art. 10.012	Ø 16			Art. 10.016	□ 14	Art. 10.020	□ 14	Art. 10.020	□ 14	Art. 10.024	□ 14
Art. 10.004.01	Ø 14	Art. 10.008.01	Ø 14	Art. 10.012.01	Ø 14			Art. 10.016.01	□ 16	Art. 10.020.01	□ 16	Art. 10.020.01	□ 16	Art. 10.024.01	□ 16
Art. 10.004.02	Ø 12	Art. 10.008.02	Ø 12	Art. 10.012.02	Ø 12			Art. 10.016.02	□ 12	Art. 10.020.02	□ 12	Art. 10.020.02	□ 12	Art. 10.024.02	□ 12

H.1800 mm.	
Art. 10.020.03	□ 14
Art. 10.020.04	□ 16
H.2000 mm.	
Art. 10.020.05	□ 14
Art. 10.020.06	□ 16

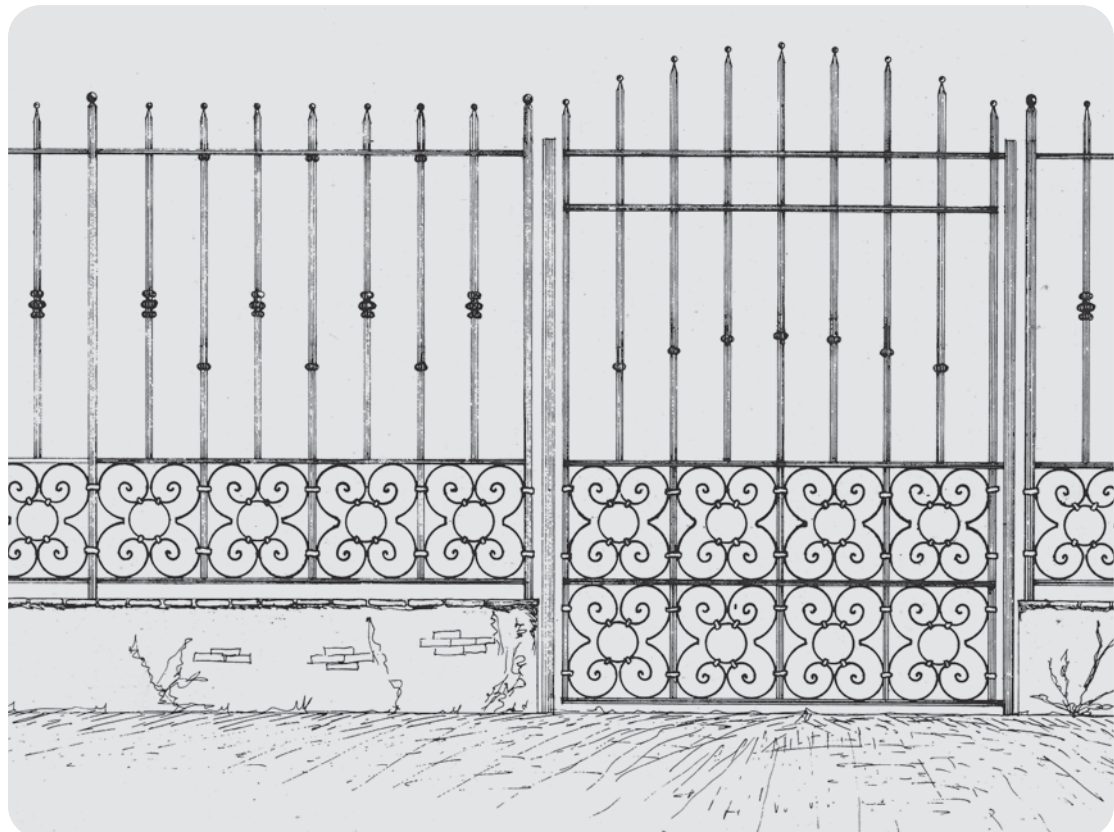

H.1500 mm.	
Art. 10.024.03	□ 14
Art. 10.024.04	□ 16
H.1800 mm.	
Art. 10.024.05	□ 14
Art. 10.024.06	□ 16
H.2000 mm.	
Art. 10.024.07	□ 14
Art. 10.024.08	□ 16

Tutte le parti di questo catalogo - foto comprese - sono di proprietà Euro-Fer. La riproduzione, anche parziale, è vietata in ogni forma e con ogni mezzo. / Every part of this catalogue - photos included - is Euro-Fer's property. All forms of copying are strictly prohibited.



<p>H.950 mm.</p> <p>Art. 10.025 <input type="checkbox"/> 14 Art. 10.025.01 <input type="checkbox"/> 16 Art. 10.025.02 <input type="checkbox"/> 12</p> <p>Art. 10.026 Ø 16 Art. 10.026.01 Ø 14 Art. 10.026.02 Ø 12</p> <p>H.1000 mm.</p> <p>Art. 10.027 <input type="checkbox"/> 14 Art. 10.027.01 <input type="checkbox"/> 16 Art. 10.027.02 <input type="checkbox"/> 12</p> <p>Art. 10.028 Ø 16 Art. 10.028.01 Ø 14 Art. 10.028.02 Ø 12</p> <p>H.1200 mm.</p> <p>Art. 10.029 <input type="checkbox"/> 14 Art. 10.029.01 <input type="checkbox"/> 16 Art. 10.029.02 <input type="checkbox"/> 12</p> <p>Art. 10.030 Ø 16 Art. 10.030.01 Ø 14 Art. 10.030.02 Ø 12</p> <p>H.1500 mm.</p> <p>Art. 10.031 <input type="checkbox"/> 14 Art. 10.031.01 <input type="checkbox"/> 16 Art. 10.031.02 <input type="checkbox"/> 12</p> <p>Art. 10.032 Ø 16 Art. 10.032.01 Ø 14 Art. 10.032.02 Ø 12</p> <p>H.2000 mm.</p> <p>Art. 10.032.18 Ø 16</p> <p>H.2500 mm. <b>NEW</b></p> <p>Art. 10.032.20 <input type="checkbox"/> 14 Art. 10.032.21 <input type="checkbox"/> 16</p>	<p>H.950 mm.</p> <p>Art. 10.033 <input type="checkbox"/> 14 Art. 10.033.01 <input type="checkbox"/> 16 Art. 10.033.02 <input type="checkbox"/> 12</p> <p>Art. 10.034 Ø 16 Art. 10.034.01 Ø 14 Art. 10.034.02 Ø 12</p> <p>H.1000 mm.</p> <p>Art. 10.035 <input type="checkbox"/> 14 Art. 10.035.01 <input type="checkbox"/> 16 Art. 10.035.02 <input type="checkbox"/> 12</p> <p>Art. 10.036 Ø 16 Art. 10.036.01 Ø 14 Art. 10.036.02 Ø 12</p> <p>H.1200 mm.</p> <p>Art. 10.037 <input type="checkbox"/> 14 Art. 10.037.01 <input type="checkbox"/> 16 Art. 10.037.02 <input type="checkbox"/> 12</p> <p>Art. 10.038 Ø 16 Art. 10.038.01 Ø 14 Art. 10.038.02 Ø 12</p> <p>H.1500 mm.</p> <p>Art. 10.039 <input type="checkbox"/> 14 Art. 10.039.01 <input type="checkbox"/> 16 Art. 10.039.02 <input type="checkbox"/> 12</p> <p>Art. 10.040 Ø 16 Art. 10.040.01 Ø 14 Art. 10.040.02 Ø 12</p>	<p>Martellato / Hammered</p> <p>H.950 mm.</p> <p>Art. 10.040.03 <input type="checkbox"/> 12 Art. 10.040.04 <input type="checkbox"/> 14 Art. 10.040.05 <input type="checkbox"/> 16</p> <p>H.1000 mm.</p> <p>Art. 10.040.06 <input type="checkbox"/> 12 Art. 10.040.07 <input type="checkbox"/> 14 Art. 10.040.08 <input type="checkbox"/> 16</p> <p>H.1200 mm.</p> <p>Art. 10.040.09 <input type="checkbox"/> 12 Art. 10.040.10 <input type="checkbox"/> 14 Art. 10.040.11 <input type="checkbox"/> 16</p> <p>H.1500 mm.</p> <p>Art. 10.040.12 <input type="checkbox"/> 12 Art. 10.040.13 <input type="checkbox"/> 14 Art. 10.040.14 <input type="checkbox"/> 16</p>	<p>Martellato / Hammered</p> <p>H.950 mm.</p> <p>Art. 10.040.15 <input type="checkbox"/> 12 Art. 10.040.16 <input type="checkbox"/> 14 Art. 10.040.17 <input type="checkbox"/> 16</p> <p>H.1000 mm.</p> <p>Art. 10.040.18 <input type="checkbox"/> 12 Art. 10.040.19 <input type="checkbox"/> 14 Art. 10.040.20 <input type="checkbox"/> 16</p> <p>H.1200 mm.</p> <p>Art. 10.040.21 <input type="checkbox"/> 12 Art. 10.040.22 <input type="checkbox"/> 14 Art. 10.040.23 <input type="checkbox"/> 16</p> <p>H.1500 mm.</p> <p>Art. 10.040.24 <input type="checkbox"/> 12 Art. 10.040.25 <input type="checkbox"/> 14 Art. 10.040.26 <input type="checkbox"/> 16</p>	<p>Martellato / Hammered</p> <p>H.950 mm.</p> <p>Art. 10.041 <input type="checkbox"/> 14 Art. 10.041.01 <input type="checkbox"/> 16 Art. 10.041.02 <input type="checkbox"/> 12</p> <p>H.1000 mm.</p> <p>Art. 10.042 <input type="checkbox"/> 14 Art. 10.042.01 <input type="checkbox"/> 16 Art. 10.042.02 <input type="checkbox"/> 12</p> <p>H.1200 mm.</p> <p>Art. 10.043 <input type="checkbox"/> 14 Art. 10.043.01 <input type="checkbox"/> 16 Art. 10.043.02 <input type="checkbox"/> 12</p> <p>H.1500 mm.</p> <p>Art. 10.044 <input type="checkbox"/> 14 Art. 10.044.01 <input type="checkbox"/> 16 Art. 10.044.02 <input type="checkbox"/> 12</p>	<p>Martellato / Hammered</p> <p>H.950 mm.</p> <p>Art. 10.045 <input type="checkbox"/> 14 Art. 10.045.01 <input type="checkbox"/> 16 Art. 10.045.02 <input type="checkbox"/> 12</p> <p>H.1000 mm.</p> <p>Art. 10.046 <input type="checkbox"/> 14 Art. 10.046.01 <input type="checkbox"/> 16 Art. 10.046.02 <input type="checkbox"/> 12</p> <p>H.1200 mm.</p> <p>Art. 10.047 <input type="checkbox"/> 14 Art. 10.047.01 <input type="checkbox"/> 16 Art. 10.047.02 <input type="checkbox"/> 12</p> <p>H.1500 mm.</p> <p>Art. 10.048 <input type="checkbox"/> 14 Art. 10.048.01 <input type="checkbox"/> 16 Art. 10.048.02 <input type="checkbox"/> 12</p>
---	--	---	---	---	---

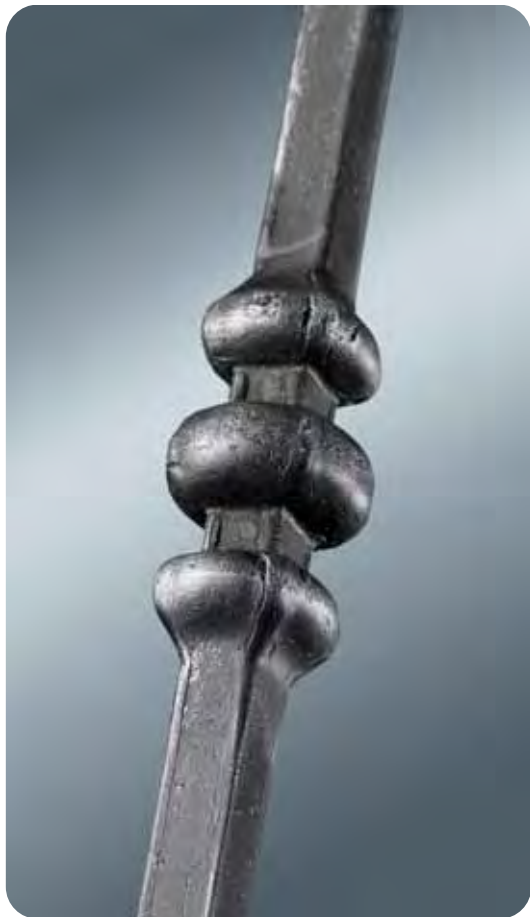

Paletti ricalcati - Tendenze Odierne / New forged bars - Modern Design

<p>Martellato/Hammered</p> <p>H.950 mm.</p> <p>Art. 09.658 <input type="checkbox"/> 12 Art. 09.659 <input type="checkbox"/> 14</p>	<p>Martellato/Hammered</p> <p>H.950 mm.</p> <p>Art. 09.660 <input type="checkbox"/> 12 Art. 09.661 <input type="checkbox"/> 14</p>	<p>H.950 mm.</p> <p>Art. 09.662 <input type="checkbox"/> 12 Art. 09.663 <input type="checkbox"/> 14</p>	<p>H.950 mm.</p> <p>Art. 09.664 <input type="checkbox"/> 12 Art. 09.665 <input type="checkbox"/> 14</p>

## ELEMENTI IN FERRO RICALCATO NEW FORGED BARS



Martellato/Hammered

H.950 mm.

- Art. 10.049  14  
Art. 10.049.01  16  
Art. 10.049.02  12

H.1000 mm.

- Art. 10.050  14  
Art. 10.050.01  16  
Art. 10.050.02  12

H.1200 mm.

- Art. 10.051  14  
Art. 10.051.01  16  
Art. 10.051.02  12

H.1500 mm.

- Art. 10.052  14  
Art. 10.052.01  16  
Art. 10.052.02  12

H.1800 mm.

- Art. 10.052.03  12  
Art. 10.052.04  14  
Art. 10.052.05  16

H.2000 mm.

- Art. 10.052.06  12  
Art. 10.052.07  14  
Art. 10.052.08  16



Martellato/Hammered

H.950 mm.

- Art. 10.053  14  
Art. 10.053.01  16  
Art. 10.053.02  12

H.1000 mm.

- Art. 10.054  14  
Art. 10.054.01  16  
Art. 10.054.02  12

H.1200 mm.

- Art. 10.055  14  
Art. 10.055.01  16  
Art. 10.055.02  12

H.1500 mm.

- Art. 10.056  14  
Art. 10.056.01  16  
Art. 10.056.02  12

Fuori Produzione  
Out of Production

- Art. 10.056.03  
Art. 10.056.04  
Art. 10.056.05

- Art. 10.056.06  
Art. 10.056.07  
Art. 10.056.08

- Art. 10.056.09  
Art. 10.056.10  
Art. 10.056.11

- Art. 10.056.12  
Art. 10.056.13  
Art. 10.056.14



H.950 mm.

- Art. 10.056.15  12  
Art. 10.056.16  14  
Art. 10.056.17  16

H.1000 mm.

- Art. 10.056.18  12  
Art. 10.056.19  14  
Art. 10.056.20  16

H.1200 mm.

- Art. 10.056.21  12  
Art. 10.056.22  14  
Art. 10.056.23  16

H.1500 mm.

- Art. 10.056.24  12  
Art. 10.056.25  14  
Art. 10.056.26  16



H.950 mm.

- Art. 10.056.27  12  
Art. 10.056.28  14  
Art. 10.056.29  16

H.1000 mm.

- Art. 10.056.30  12  
Art. 10.056.31  14  
Art. 10.056.32  16

H.1200 mm.

- Art. 10.056.33  12  
Art. 10.056.34  14  
Art. 10.056.35  16

H.1500 mm.

- Art. 10.056.36  12  
Art. 10.056.37  14  
Art. 10.056.38  16



H.950 mm.

- Art. 10.056.39  12  
Art. 10.056.40  14  
Art. 10.056.41  16

H.1000 mm.

- Art. 10.056.42  12  
Art. 10.056.43  14  
Art. 10.056.44  16

H.1200 mm.

- Art. 10.056.45  12  
Art. 10.056.46  14  
Art. 10.056.47  16

H.1500 mm.

- Art. 10.056.48  12  
Art. 10.056.49  14  
Art. 10.056.50  16



H.950 mm.

- Art. 10.056.51  12  
Art. 10.056.52  14  
Art. 10.056.53  16

H.1000 mm.

- Art. 10.056.54  12  
Art. 10.056.55  14  
Art. 10.056.56  16

H.1200 mm.

- Art. 10.056.57  12  
Art. 10.056.58  14  
Art. 10.056.59  16

H.1500 mm.

- Art. 10.056.60  12  
Art. 10.056.61  14  
Art. 10.056.62  16

### PALLINE GRANDI / LARGE BALLS



H.950 mm.

- Art. 10.057  14  
Art. 10.057.01  16  
Art. 10.057.02  12

H.1000 mm.

- Art. 10.058  14  
Art. 10.058.01  16  
Art. 10.058.02  12

H.1200 mm.

- Art. 10.059  14  
Art. 10.059.01  16  
Art. 10.059.02  12

H.1400 mm.

- Art. 10.059.10  14 **NEW**

H.1500 mm.

- Art. 10.060  14  
Art. 10.060.01  16  
Art. 10.060.02  12

H.1700 mm.

- Art. 10.060.10  14 **NEW**



H.950 mm.

- Art. 10.061  14  
Art. 10.061.01  16  
Art. 10.061.02  12

Art. 10.062  $\varnothing$  16Art. 10.062.01  $\varnothing$  14Art. 10.062.02  $\varnothing$  12

H.1000 mm.

- Art. 10.063  14  
Art. 10.063.01  16  
Art. 10.063.02  12

Art. 10.064  $\varnothing$  16Art. 10.064.01  $\varnothing$  14Art. 10.064.02  $\varnothing$  12

H.1200 mm.

- Art. 10.065  14  
Art. 10.065.01  16  
Art. 10.065.02  12

Art. 10.066  $\varnothing$  16Art. 10.066.01  $\varnothing$  14Art. 10.066.02  $\varnothing$  12

H.1500 mm.

- Art. 10.067  14  
Art. 10.067.01  16  
Art. 10.067.02  12

Art. 10.068  $\varnothing$  16Art. 10.068.01  $\varnothing$  14Art. 10.068.02  $\varnothing$  12

H.950 mm.

- Art. 10.068.60  14  
Art. 10.068.61  12

H.1000 mm.

- Art. 10.068.62  14  
Art. 10.068.63  12

H.1200 mm.

- Art. 10.068.64  14  
Art. 10.068.65  12

H.1500 mm.

- Art. 10.068.66  14  
Art. 10.068.67  12



H.950 mm.

- Art. 10.069  14  
Art. 10.069.01  16  
Art. 10.069.02  12

Art. 10.070  $\varnothing$  16Art. 10.070.01  $\varnothing$  14Art. 10.070.02  $\varnothing$  12

H.1000 mm.

- Art. 10.071  14  
Art. 10.071.01  16  
Art. 10.071.02  12

Art. 10.072  $\varnothing$  16Art. 10.072.01  $\varnothing$  14Art. 10.072.02  $\varnothing$  12

H.1200 mm.

- Art. 10.073  14  
Art. 10.073.01  16  
Art. 10.073.02  12

Art. 10.074  $\varnothing$  16Art. 10.074.01  $\varnothing$  14Art. 10.074.02  $\varnothing$  12

H.1500 mm.

- Art. 10.075  14  
Art. 10.075.01  16  
Art. 10.075.02  12

Art. 10.076  $\varnothing$  16Art. 10.076.01  $\varnothing$  14Art. 10.076.02  $\varnothing$  12

H.950 mm.

- Art. 10.077  14  
Art. 10.077.01  16  
Art. 10.077.02  12

Art. 10.078  $\varnothing$  16Art. 10.078.01  $\varnothing$  14Art. 10.078.02  $\varnothing$  12

H.1000 mm.

- Art. 10.079  14  
Art. 10.079.01  16  
Art. 10.079.02  12

Art. 10.080  $\varnothing$  16Art. 10.080.01  $\varnothing$  14Art. 10.080.02  $\varnothing$  12

H.1200 mm.

- Art. 10.081  14  
Art. 10.081.01  16  
Art. 10.081.02  12

Art. 10.082  $\varnothing$  16Art. 10.082.01  $\varnothing$  14Art. 10.082.02  $\varnothing$  12

H.1500 mm.

- Art. 10.083  14  
Art. 10.083.01  16  
Art. 10.083.02  12













Art. 10.084  $\varnothing$  16Art. 10.084.01  $\varnothing$  14Art. 10.084.02  $\varnothing$  12

# ELEMENTI IN FERRO RICALCATO NEW FORGED BARS

10

PALLINE GRANDI / LARGE BALLS

NEW

						
H.950 mm. Art. 10.085 □ 14 Art. 10.085.01 □ 16 Art. 10.085.02 □ 12 Art. 10.086 Ø 16 Art. 10.086.01 Ø 14 Art. 10.086.02 Ø 12	H.950 mm. Art. 10.093 □ 14 Art. 10.093.01 □ 16 Art. 10.093.02 □ 12 Art. 10.094 Ø 16 Art. 10.094.01 Ø 14 Art. 10.094.02 Ø 12	H.950 mm. Art. 10.101 □ 14 Art. 10.101.01 □ 16 Art. 10.101.02 □ 12 Art. 10.102 Ø 16 Art. 10.102.01 Ø 14 Art. 10.102.02 Ø 12	H.950 mm. Art. 10.108.60 □ 14 Art. 10.108.61 □ 16 Art. 10.108.62 □ 12 Art. 10.108.63 Ø 16 Art. 10.108.64 Ø 14 Art. 10.108.65 Ø 12	H.1000 mm. Art. 10.108.106 □ 14 Art. 10.108.108 □ 12	H.950 mm. Art. 10.109 □ 14 Art. 10.109.01 □ 16 Art. 10.109.02 □ 12 Art. 10.110 Ø 16 Art. 10.110.01 Ø 14 Art. 10.110.02 Ø 12	H.950 mm. Art. 10.117 □ 14 Art. 10.117.01 □ 16 Art. 10.117.02 □ 12 Art. 10.118 Ø 16 Art. 10.118.01 Ø 14 Art. 10.118.02 Ø 12
H.1000 mm. Art. 10.087 □ 14 Art. 10.087.01 □ 16 Art. 10.087.02 □ 12 Art. 10.088 Ø 16 Art. 10.088.01 Ø 14 Art. 10.088.02 Ø 12	H.1000 mm. Art. 10.095 □ 14 Art. 10.095.01 □ 16 Art. 10.095.02 □ 12 Art. 10.096 Ø 16 Art. 10.096.01 Ø 14 Art. 10.096.02 Ø 12	H.1000 mm. Art. 10.103 □ 14 Art. 10.103.01 □ 16 Art. 10.103.02 □ 12 Art. 10.104 Ø 16 Art. 10.104.01 Ø 14 Art. 10.104.02 Ø 12	H.1000 mm. Art. 10.108.66 □ 14 Art. 10.108.67 □ 16 Art. 10.108.68 □ 12 Art. 10.108.69 Ø 16 Art. 10.108.70 Ø 14 Art. 10.108.71 Ø 12	H.1000 mm. Art. 10.108.72 □ 14 Art. 10.108.73 □ 16 Art. 10.108.74 □ 12 Art. 10.108.75 Ø 16 Art. 10.108.76 Ø 14 Art. 10.108.77 Ø 12	H.1000 mm. Art. 10.111 □ 14 Art. 10.111.01 □ 16 Art. 10.111.02 □ 12 Art. 10.112 Ø 16 Art. 10.112.01 Ø 14 Art. 10.112.02 Ø 12	H.1000 mm. Art. 10.119 □ 14 Art. 10.119.01 □ 16 Art. 10.119.02 □ 12 Art. 10.120 Ø 16 Art. 10.120.01 Ø 14 Art. 10.120.02 Ø 12
H.1200 mm. Art. 10.089 □ 14 Art. 10.089.01 □ 16 Art. 10.089.02 □ 12 Art. 10.090 Ø 16 Art. 10.090.01 Ø 14 Art. 10.090.02 Ø 12	H.1200 mm. Art. 10.097 □ 14 Art. 10.097.01 □ 16 Art. 10.097.02 □ 12 Art. 10.098 Ø 16 Art. 10.098.01 Ø 14 Art. 10.098.02 Ø 12	H.1200 mm. Art. 10.105 □ 14 Art. 10.105.01 □ 16 Art. 10.105.02 □ 12 Art. 10.106 Ø 16 Art. 10.106.01 Ø 14 Art. 10.106.02 Ø 12	H.1200 mm. Art. 10.108.72 □ 14 Art. 10.108.73 □ 16 Art. 10.108.74 □ 12 Art. 10.108.75 Ø 16 Art. 10.108.76 Ø 14 Art. 10.108.77 Ø 12	H.1200 mm. Art. 10.108.78 □ 14 Art. 10.108.79 □ 16 Art. 10.108.80 □ 12 Art. 10.108.81 Ø 16 Art. 10.108.82 Ø 14 Art. 10.108.83 Ø 12	H.1200 mm. Art. 10.113 □ 14 Art. 10.113.01 □ 16 Art. 10.113.02 □ 12 Art. 10.114 Ø 16 Art. 10.114.01 Ø 14 Art. 10.114.02 Ø 12	H.1200 mm. Art. 10.121 □ 14 Art. 10.121.01 □ 16 Art. 10.121.02 □ 12 Art. 10.122 Ø 16 Art. 10.122.01 Ø 14 Art. 10.122.02 Ø 12
H.1500 mm. Art. 10.091 □ 14 Art. 10.091.01 □ 16 Art. 10.091.02 □ 12 Art. 10.092 Ø 16 Art. 10.092.01 Ø 14 Art. 10.092.02 Ø 12	H.1500 mm. Art. 10.099 □ 14 Art. 10.099.01 □ 16 Art. 10.099.02 □ 12 Art. 10.100 Ø 16 Art. 10.100.01 Ø 14 Art. 10.100.02 Ø 12	H.1500 mm. Art. 10.107 □ 14 Art. 10.107.01 □ 16 Art. 10.107.02 □ 12 Art. 10.108 Ø 16 Art. 10.108.01 Ø 14 Art. 10.108.02 Ø 12	H.1500 mm. Art. 10.108.78 □ 14 Art. 10.108.79 □ 16 Art. 10.108.80 □ 12 Art. 10.108.81 Ø 16 Art. 10.108.82 Ø 14 Art. 10.108.83 Ø 12	H.1500 mm. Art. 10.108.78 □ 14 Art. 10.108.79 □ 16 Art. 10.108.80 □ 12 Art. 10.108.81 Ø 16 Art. 10.108.82 Ø 14 Art. 10.108.83 Ø 12	H.1500 mm. Art. 10.115 □ 14 Art. 10.115.01 □ 16 Art. 10.115.02 □ 12 Art. 10.116 Ø 16 Art. 10.116.01 Ø 14 Art. 10.116.02 Ø 12	H.1500 mm. Art. 10.123 □ 14 Art. 10.123.01 □ 16 Art. 10.123.02 □ 12 Art. 10.124 Ø 16 Art. 10.124.01 Ø 14 Art. 10.124.02 Ø 12
						
H.950 mm. Art. 10.125 □ 14 Art. 10.125.01 □ 16 Art. 10.125.02 □ 12 Art. 10.126 Ø 16 Art. 10.126.01 Ø 14 Art. 10.126.02 Ø 12	H.950 mm. Art. 10.133 □ 14 Art. 10.133.01 □ 16 Art. 10.133.02 □ 12 Art. 10.134 Ø 16 Art. 10.134.01 Ø 14 Art. 10.134.02 Ø 12	H.950 mm. Art. 10.141 □ 14 Art. 10.141.01 □ 16 Art. 10.141.02 □ 12 Art. 10.142 Ø 16 Art. 10.142.01 Ø 14 Art. 10.142.02 Ø 12	H.950 mm. Art. 10.141 □ 14 Art. 10.141.01 □ 16 Art. 10.141.02 □ 12 Art. 10.142 Ø 16 Art. 10.142.01 Ø 14 Art. 10.142.02 Ø 12	H.950 mm. Art. 10.141 □ 14 Art. 10.141.01 □ 16 Art. 10.141.02 □ 12 Art. 10.142 Ø 16 Art. 10.142.01 Ø 14 Art. 10.142.02 Ø 12	Martellato Hammered H.950 mm. Art. 10.148.03 □ 12 Art. 10.148.04 □ 14 Art. 10.148.05 □ 16	H.950 mm. Art. 10.148.50 □ 12 Art. 10.148.51 □ 14 Art. 10.148.52 □ 16
H.1000 mm. Art. 10.127 □ 14 Art. 10.127.01 □ 16 Art. 10.127.02 □ 12 Art. 10.128 Ø 16 Art. 10.128.01 Ø 14 Art. 10.128.02 Ø 12	H.1000 mm. Art. 10.135 □ 14 Art. 10.135.01 □ 16 Art. 10.135.02 □ 12 Art. 10.136 Ø 16 Art. 10.136.01 Ø 14 Art. 10.136.02 Ø 12	H.1000 mm. Art. 10.143 □ 14 Art. 10.143.01 □ 16 Art. 10.143.02 □ 12 Art. 10.144 Ø 16 Art. 10.144.01 Ø 14 Art. 10.144.02 Ø 12	H.1000 mm. Art. 10.143 □ 14 Art. 10.143.01 □ 16 Art. 10.143.02 □ 12 Art. 10.144 Ø 16 Art. 10.144.01 Ø 14 Art. 10.144.02 Ø 12	H.1000 mm. Art. 10.143 □ 14 Art. 10.143.01 □ 16 Art. 10.143.02 □ 12 Art. 10.144 Ø 16 Art. 10.144.01 Ø 14 Art. 10.144.02 Ø 12	H.1000 mm. Art. 10.148.06 □ 12 Art. 10.148.07 □ 14 Art. 10.148.08 □ 16	H.1000 mm. Art. 10.148.53 □ 12 Art. 10.148.54 □ 14 Art. 10.148.55 □ 16
H.1200 mm. Art. 10.129 □ 14 Art. 10.129.01 □ 16 Art. 10.129.02 □ 12 Art. 10.130 Ø 16 Art. 10.130.01 Ø 14 Art. 10.130.02 Ø 12	H.1200 mm. Art. 10.137 □ 14 Art. 10.137.01 □ 16 Art. 10.137.02 □ 12 Art. 10.138 Ø 16 Art. 10.138.01 Ø 14 Art. 10.138.02 Ø 12	H.1200 mm. Art. 10.145 □ 14 Art. 10.145.01 □ 16 Art. 10.145.02 □ 12 Art. 10.146 Ø 16 Art. 10.146.01 Ø 14 Art. 10.146.02 Ø 12	H.1200 mm. Art. 10.145 □ 14 Art. 10.145.01 □ 16 Art. 10.145.02 □ 12 Art. 10.146 Ø 16 Art. 10.146.01 Ø 14 Art. 10.146.02 Ø 12	H.1200 mm. Art. 10.145 □ 14 Art. 10.145.01 □ 16 Art. 10.145.02 □ 12 Art. 10.146 Ø 16 Art. 10.146.01 Ø 14 Art. 10.146.02 Ø 12	H.1200 mm. Art. 10.148.09 □ 12 Art. 10.148.10 □ 14 Art. 10.148.11 □ 16	H.1200 mm. Art. 10.148.56 □ 12 Art. 10.148.57 □ 14 Art. 10.148.58 □ 16
H.1500 mm. Art. 10.131 □ 14 Art. 10.131.01 □ 16 Art. 10.131.02 □ 12 Art. 10.132 Ø 16 Art. 10.132.01 Ø 14 Art. 10.132.02 Ø 12	H.1500 mm. Art. 10.139 □ 14 Art. 10.139.01 □ 16 Art. 10.139.02 □ 12 Art. 10.140 Ø 16 Art. 10.140.01 Ø 14 Art. 10.140.02 Ø 12	H.1500 mm. Art. 10.147 □ 14 Art. 10.147.01 □ 16 Art. 10.147.02 □ 12 Art. 10.148 Ø 16 Art. 10.148.01 Ø 14 Art. 10.148.02 Ø 12	H.1500 mm. Art. 10.147 □ 14 Art. 10.147.01 □ 16 Art. 10.147.02 □ 12 Art. 10.148 Ø 16 Art. 10.148.01 Ø 14 Art. 10.148.02 Ø 12	H.1500 mm. Art. 10.147 □ 14 Art. 10.147.01 □ 16 Art. 10.147.02 □ 12 Art. 10.148 Ø 16 Art. 10.148.01 Ø 14 Art. 10.148.02 Ø 12	H.1500 mm. Art. 10.148.12 □ 12 Art. 10.148.13 □ 14 Art. 10.148.14 □ 16	H.1500 mm. Art. 10.148.59 □ 12 Art. 10.148.60 □ 14 Art. 10.148.61 □ 16

Tutte le parti di questo catalogo - foto comprese - sono di proprietà Euro-Fer. La riproduzione, anche parziale, è vietata in ogni forma e con ogni mezzo. / Every part of this catalogue - photos included - is Euro-Fer's property. All forms of copying are strictly prohibited.

from art. 10.085 to art. 10.148.61

**EUROFER** 159



NEW

PALLINE PICCOLE / SMALL BALLS

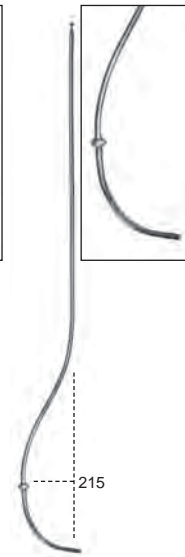
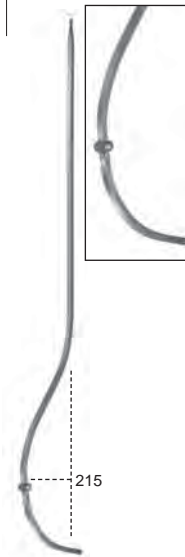
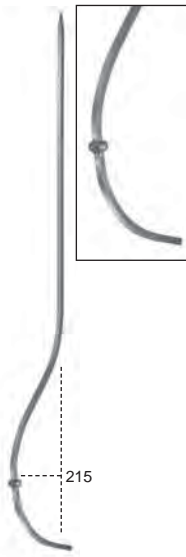
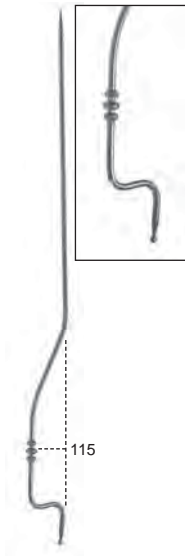
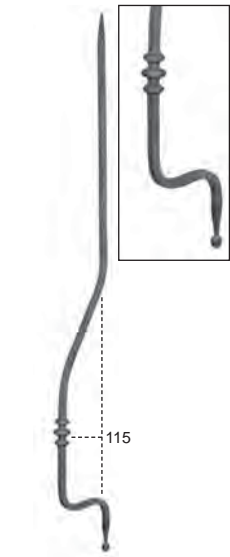

Tondo / Round

- H.950 mm.
- Art. 10.149 □14
- Art. 10.149.01 □16
- Art. 10.149.02 □12
- H.1000 mm.
- Art. 10.150 □14
- Art. 10.150.01 □16
- Art. 10.150.02 □12
- H.1200 mm.
- Art. 10.151 □14
- Art. 10.151.01 □16
- Art. 10.151.02 □12
- H.1500 mm.
- Art. 10.152 □14
- Art. 10.152.01 □16
- Art. 10.152.02 □12

- H.950 mm.
- Art. 10.152.03 Ø 14
- Art. 10.152.04 Ø 16
- H.1200 mm.
- Art. 10.152.05 Ø 14
- Art. 10.152.06 Ø 16
- H.1500 mm.
- Art. 10.152.07 Ø 14
- Art. 10.152.08 Ø 16
- H.1800 mm.
- Art. 10.152.09 Ø 14
- Art. 10.152.10 Ø 16

- H 1000 mm.
- Art. 10.152.41 □12
- Art. 10.152.42 □14
- H 1600 mm.
- Art. 10.152.55 □14
- H 1700 mm.
- Art. 10.152.56 □14
- H 1800 mm.
- Art. 10.152.57 □14

- H.1000 mm.
- Art. 10.152.11 □12
- Art. 10.152.12 □14
- Art. 10.152.13 □16
- H.1200 mm.
- Art. 10.152.14 □12
- Art. 10.152.15 □14
- Art. 10.152.16 □16
- H.1500 mm.
- Art. 10.152.17 □12
- Art. 10.152.18 □14
- Art. 10.152.19 □16
- H.1800 mm.
- Art. 10.152.20 □12
- Art. 10.152.21 □14
- Art. 10.152.22 □16

Tondo / Round

- H.1000 mm.
- Art. 10.152.23 Ø 14
- Art. 10.152.24 Ø 16
- H.1200 mm.
- Art. 10.152.25 Ø 14
- Art. 10.152.26 Ø 16
- H.1500 mm.
- Art. 10.152.27 Ø 14
- Art. 10.152.28 Ø 16
- H.1800 mm.
- Art. 10.152.29 Ø 14
- Art. 10.152.30 Ø 16

Tondo / Round

- H.950 mm.
- Art. 10.153 Ø 12
- Art. 10.154 Ø 14
- Art. 10.155 Ø 16
- H.1000 mm.
- Art. 10.156 Ø 12
- Art. 10.157 Ø 14
- Art. 10.158 Ø 16
- H.1200 mm.
- Art. 10.159 Ø 12
- Art. 10.160 Ø 14
- Art. 10.161 Ø 16
- H.1500 mm.
- Art. 10.162 Ø 12
- Art. 10.163 Ø 14
- Art. 10.164 Ø 16

Tondo / Round

- H.950 mm.
- Art. 10.165 Ø 12
- Art. 10.166 Ø 14
- Art. 10.167 Ø 16
- H.1000 mm.
- Art. 10.168 Ø 12
- Art. 10.169 Ø 14
- Art. 10.170 Ø 16
- H.1200 mm.
- Art. 10.171 Ø 12
- Art. 10.172 Ø 14
- Art. 10.173 Ø 16
- H.1500 mm.
- Art. 10.174 Ø 12
- Art. 10.175 Ø 14
- Art. 10.176 Ø 16

Tondo / Round

- H.950 mm.
- Art. 10.177 Ø 12
- Art. 10.178 Ø 14
- Art. 10.179 Ø 16
- H.1000 mm.
- Art. 10.180 Ø 12
- Art. 10.181 Ø 14
- Art. 10.182 Ø 16
- H.1200 mm.
- Art. 10.183 Ø 12
- Art. 10.184 Ø 14
- Art. 10.185 Ø 16
- H.1500 mm.
- Art. 10.186 Ø 12
- Art. 10.187 Ø 14
- Art. 10.188 Ø 16

PALLINE PICCOLE / SMALL BALLS



Tondo / Round

- H.950 mm.
- Art. 10.189 Ø 12
- Art. 10.190 Ø 14
- Art. 10.191 Ø 16
- H.1000 mm.
- Art. 10.192 Ø 12
- Art. 10.193 Ø 14
- Art. 10.194 Ø 16
- H.1200 mm.
- Art. 10.195 Ø 12
- Art. 10.196 Ø 14
- Art. 10.197 Ø 16
- H.1500 mm.
- Art. 10.198 Ø 12
- Art. 10.199 Ø 14
- Art. 10.200 Ø 16

Tondo / Round

- H.950 mm.
- Art. 10.201 Ø 12
- Art. 10.202 Ø 14
- Art. 10.203 Ø 16
- H.1000 mm.
- Art. 10.204 Ø 12
- Art. 10.205 Ø 14
- Art. 10.206 Ø 16
- H.1200 mm.
- Art. 10.207 Ø 12
- Art. 10.208 Ø 14
- Art. 10.209 Ø 16
- H.1500 mm.
- Art. 10.210 Ø 12
- Art. 10.211 Ø 14
- Art. 10.212 Ø 16

H.950 mm.

- Art. 10.213 □12
- Art. 10.214 □14
- Art. 10.215 □16

H.1000 mm.

- Art. 10.216 □12
- Art. 10.217 □14
- Art. 10.218 □16

H.1200 mm.

- Art. 10.219 □12
- Art. 10.220 □14
- Art. 10.221 □16

H.1500 mm.

- Art. 10.222 □12
- Art. 10.223 □14
- Art. 10.224 □16

H.950 mm.

- Art. 10.225 □12
- Art. 10.226 □14
- Art. 10.227 □16

H.1000 mm.

- Art. 10.228 □12
- Art. 10.229 □14
- Art. 10.230 □16

H.1200 mm.

- Art. 10.231 □12
- Art. 10.232 □14
- Art. 10.233 □16

H.1500 mm.

- Art. 10.234 □12
- Art. 10.235 □14
- Art. 10.236 □16

H.950 mm.

- Art. 10.237 □12
- Art. 10.238 □14
- Art. 10.239 □16

H.1000 mm.

- Art. 10.240 □12
- Art. 10.241 □14
- Art. 10.242 □16

H.1200 mm.

- Art. 10.243 □12
- Art. 10.244 □14
- Art. 10.245 □16

H.1500 mm.

- Art. 10.246 □12
- Art. 10.247 □14
- Art. 10.248 □16

H.950 mm.

- Art. 10.249 □12
- Art. 10.250 □14
- Art. 10.251 □16

H.1000 mm.

- Art. 10.252 □12
- Art. 10.253 □14
- Art. 10.254 □16

H.1200 mm.

- Art. 10.255 □12
- Art. 10.256 □14
- Art. 10.257 □16

H.1500 mm.

- Art. 10.258 □12
- Art. 10.259 □14
- Art. 10.260 □16

H.950 mm.

- Art. 10.261 □12
- Art. 10.262 □14
- Art. 10.263 □16

H.1000 mm.

- Art. 10.264 □12
- Art. 10.265 □14
- Art. 10.266 □16

H.1200 mm.

- Art. 10.267 □12
- Art. 10.268 □14
- Art. 10.269 □16

H.1500 mm.

- Art. 10.270 □12
- Art. 10.271 □14
- Art. 10.272 □16

PALLINE PICCOLE / SMALL BALLS



*Martellato  
Hammered*  
H.950 mm.  
Art. 10.273 □12  
Art. 10.274 □14  
Art. 10.275 □16  
H.1000 mm.  
Art. 10.276 □12  
Art. 10.277 □14  
Art. 10.278 □16  
H.1200 mm.  
Art. 10.279 □12  
Art. 10.280 □14  
Art. 10.281 □16  
H.1500 mm.  
Art. 10.282 □12  
Art. 10.283 □14  
Art. 10.284 □16

*Martellato  
Hammered*  
H.950 mm.  
Art. 10.285 □12  
Art. 10.286 □14  
Art. 10.287 □16  
H.1000 mm.  
Art. 10.288 □12  
Art. 10.289 □14  
Art. 10.290 □16  
H.1200 mm.  
Art. 10.291 □12  
Art. 10.292 □14  
Art. 10.293 □16  
H.1500 mm.  
Art. 10.294 □12  
Art. 10.295 □14  
Art. 10.296 □16

*Martellato  
Hammered*  
H.950 mm.  
Art. 10.297 □12  
Art. 10.298 □14  
Art. 10.299 □16  
H.1000 mm.  
Art. 10.300 □12  
Art. 10.301 □14  
Art. 10.302 □16  
H.1200 mm.  
Art. 10.303 □12  
Art. 10.304 □14  
Art. 10.305 □16  
H.1500 mm.  
Art. 10.306 □12  
Art. 10.307 □14  
Art. 10.308 □16

*Martellato  
Hammered*  
H.950 mm.  
Art. 10.309 □12  
Art. 10.310 □14  
Art. 10.311 □16  
H.1000 mm.  
Art. 10.312 □12  
Art. 10.313 □14  
Art. 10.314 □16  
H.1200 mm.  
Art. 10.315 □12  
Art. 10.316 □14  
Art. 10.317 □16  
H.1500 mm.  
Art. 10.318 □12  
Art. 10.319 □14  
Art. 10.320 □16

*Martellato  
Hammered*  
H.950 mm.  
Art. 10.321 □12  
Art. 10.322 □14  
Art. 10.323 □16  
H.1000 mm.  
Art. 10.324 □12  
Art. 10.325 □14  
Art. 10.326 □16  
H.1200 mm.  
Art. 10.327 □12  
Art. 10.328 □14  
Art. 10.329 □16  
H.1500 mm.  
Art. 10.330 □12  
Art. 10.331 □14  
Art. 10.332 □16

*Tondo / Round*  
H.950 mm.  
Art. 10.333 Ø 12  
Art. 10.334 Ø 14  
Art. 10.335 Ø 16  
H.1000 mm.  
Art. 10.336 Ø 12  
Art. 10.337 Ø 14  
Art. 10.338 Ø 16  
H.1200 mm.  
Art. 10.339 Ø 12  
Art. 10.340 Ø 14  
Art. 10.341 Ø 16  
H.1500 mm.  
Art. 10.342 Ø 12  
Art. 10.343 Ø 14  
Art. 10.344 Ø 16

*Tondo / Round*  
H.950 mm.  
Art. 10.345 Ø 12  
Art. 10.346 Ø 14  
Art. 10.347 Ø 16  
H.1000 mm.  
Art. 10.348 Ø 12  
Art. 10.349 Ø 14  
Art. 10.350 Ø 16  
H.1200 mm.  
Art. 10.351 Ø 12  
Art. 10.352 Ø 14  
Art. 10.353 Ø 16  
H.1500 mm.  
Art. 10.354 Ø 12  
Art. 10.355 Ø 14  
Art. 10.356 Ø 16

PALLINE PICCOLE / SMALL BALLS

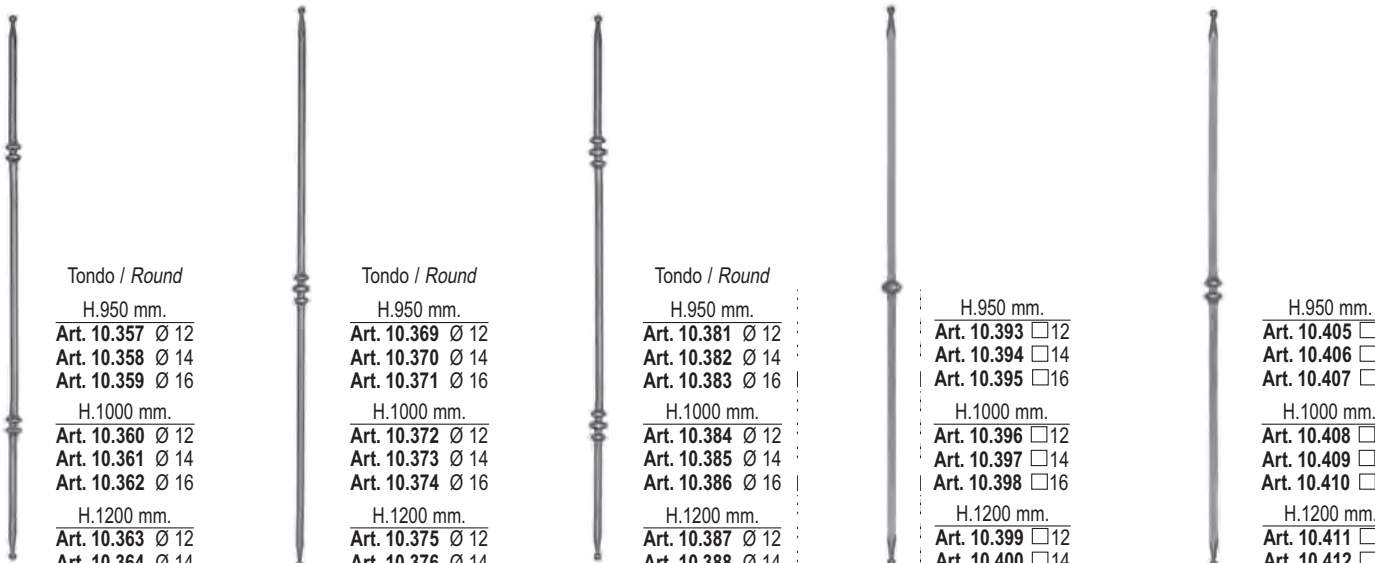

*Tondo / Round*  
H.950 mm.  
Art. 10.357 Ø 12  
Art. 10.358 Ø 14  
Art. 10.359 Ø 16  
H.1000 mm.  
Art. 10.360 Ø 12  
Art. 10.361 Ø 14  
Art. 10.362 Ø 16  
H.1200 mm.  
Art. 10.363 Ø 12  
Art. 10.364 Ø 14  
Art. 10.365 Ø 16  
H.1500 mm.  
Art. 10.366 Ø 12  
Art. 10.367 Ø 14  
Art. 10.368 Ø 16

*Tondo / Round*  
H.950 mm.  
Art. 10.369 Ø 12  
Art. 10.370 Ø 14  
Art. 10.371 Ø 16  
H.1000 mm.  
Art. 10.372 Ø 12  
Art. 10.373 Ø 14  
Art. 10.374 Ø 16  
H.1200 mm.  
Art. 10.375 Ø 12  
Art. 10.376 Ø 14  
Art. 10.377 Ø 16  
H.1500 mm.  
Art. 10.378 Ø 12  
Art. 10.379 Ø 14  
Art. 10.380 Ø 16

*Tondo / Round*  
H.950 mm.  
Art. 10.381 Ø 12  
Art. 10.382 Ø 14  
Art. 10.383 Ø 16  
H.1000 mm.  
Art. 10.384 Ø 12  
Art. 10.385 Ø 14  
Art. 10.386 Ø 16  
H.1200 mm.  
Art. 10.387 Ø 12  
Art. 10.388 Ø 14  
Art. 10.389 Ø 16  
H.1500 mm.  
Art. 10.390 Ø 12  
Art. 10.391 Ø 14  
Art. 10.392 Ø 16

H.950 mm.  
Art. 10.393 □12  
Art. 10.394 □14  
Art. 10.395 □16  
H.1000 mm.  
Art. 10.396 □12  
Art. 10.397 □14  
Art. 10.398 □16  
H.1200 mm.  
Art. 10.399 □12  
Art. 10.400 □14  
Art. 10.401 □16  
H.1500 mm.  
Art. 10.402 □12  
Art. 10.403 □14  
Art. 10.404 □16

H.950 mm.  
Art. 10.405 □12  
Art. 10.406 □14  
Art. 10.407 □16  
H.1000 mm.  
Art. 10.408 □12  
Art. 10.409 □14  
Art. 10.410 □16  
H.1200 mm.  
Art. 10.411 □12  
Art. 10.412 □14  
Art. 10.413 □16  
H.1500 mm.  
Art. 10.414 □12  
Art. 10.415 □14  
Art. 10.416 □16

Tutte le parti di questo catalogo - foto comprese - sono di proprietà Euro-Fer. La riproduzione, anche parziale, è vietata in ogni forma e con ogni mezzo. / Every part of this catalogue - photos included - is Euro-Fer's property. All forms of copying are strictly prohibited.

PALLINE PICCOLE / SMALL BALLS



H.950 mm.  
Art. 10.417 12  
Art. 10.418 14  
Art. 10.419 16

H.950 mm.  
Art. 10.429 12  
Art. 10.430 14  
Art. 10.431 16

H.950 mm.  
Art. 10.441 12  
Art. 10.442 14  
Art. 10.443 16

Martellato  
Hammered  
H.950 mm.  
Art. 10.453 12  
Art. 10.454 14  
Art. 10.455 16

Martellato  
Hammered  
H.950 mm.  
Art. 10.465 12  
Art. 10.466 14  
Art. 10.467 16

Martellato  
Hammered  
H.950 mm.  
Art. 10.477 12  
Art. 10.478 14  
Art. 10.479 16

Martellato  
Hammered  
H.950 mm.  
Art. 10.489 12  
Art. 10.490 14  
Art. 10.491 16

H.1000 mm.  
Art. 10.420 12  
Art. 10.421 14  
Art. 10.422 16

H.1000 mm.  
Art. 10.432 12  
Art. 10.433 14  
Art. 10.434 16

H.1000 mm.  
Art. 10.444 12  
Art. 10.445 14  
Art. 10.446 16

H.1000 mm.  
Art. 10.456 12  
Art. 10.457 14  
Art. 10.458 16

H.1000 mm.  
Art. 10.468 12  
Art. 10.469 14  
Art. 10.470 16

H.1000 mm.  
Art. 10.480 12  
Art. 10.481 14  
Art. 10.482 16

H.1000 mm.  
Art. 10.492 12  
Art. 10.493 14  
Art. 10.494 16

H.1200 mm.  
Art. 10.423 12  
Art. 10.424 14  
Art. 10.425 16

H.1200 mm.  
Art. 10.435 12  
Art. 10.436 14  
Art. 10.437 16

H.1200 mm.  
Art. 10.447 12  
Art. 10.448 14  
Art. 10.449 16

H.1200 mm.  
Art. 10.459 12  
Art. 10.460 14  
Art. 10.461 16

H.1200 mm.  
Art. 10.471 12  
Art. 10.472 14  
Art. 10.473 16

H.1200 mm.  
Art. 10.483 12  
Art. 10.484 14  
Art. 10.485 16

H.1200 mm.  
Art. 10.495 12  
Art. 10.496 14  
Art. 10.497 16

H.1500 mm.  
Art. 10.426 12  
Art. 10.427 14  
Art. 10.428 16

H.1500 mm.  
Art. 10.438 12  
Art. 10.439 14  
Art. 10.440 16

H.1500 mm.  
Art. 10.450 12  
Art. 10.451 14  
Art. 10.452 16

H.1500 mm.  
Art. 10.462 12  
Art. 10.463 14  
Art. 10.464 16

H.1500 mm.  
Art. 10.474 12  
Art. 10.475 14  
Art. 10.476 16

H.1500 mm.  
Art. 10.486 12  
Art. 10.487 14  
Art. 10.488 16

H.1500 mm.  
Art. 10.498 12  
Art. 10.499 14  
Art. 10.500 16

PALLINE PICCOLE / SMALL BALLS



Martellato  
Hammered

H.950 mm.  
Art. 10.501 12  
Art. 10.502 14  
Art. 10.503 16

H.1000 mm.  
Art. 10.504 12  
Art. 10.505 14  
Art. 10.506 16

H.1200 mm.  
Art. 10.507 12  
Art. 10.508 14  
Art. 10.509 16

H.1500 mm.  
Art. 10.510 12  
Art. 10.511 14  
Art. 10.512 16



Liscio / Smooth  
H 950 x L.130 mm  
Art. 10.600 12

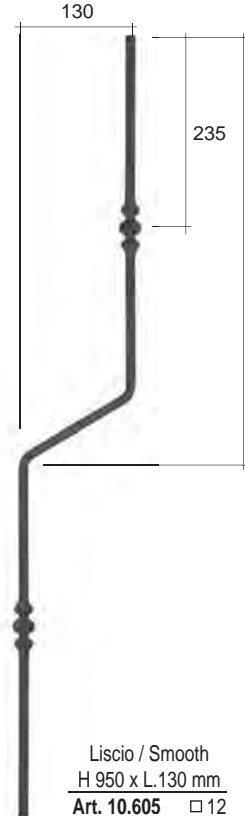

Liscio / Smooth  
H 950 x L.130 mm  
Art. 10.605 12



Liscio / Smooth  
H 950 x L.130 mm  
Art. 10.650 12



Nuovi ricalcati corteccia e rigati martellati / *New forged bars bark model and fluted hammered*



Corteccia / *Bark model*  
H.950 mm

- Art. 10.001.CO Ø 16
  - Art. 10.001.01.CO Ø 14
  - Art. 10.001.02.CO Ø 12
  - Art. 10.013.CO □ 14
  - Art. 10.013.01.CO □ 16
  - Art. 10.013.02.CO □ 12
- H.1000 mm
- Art. 10.002.CO Ø 16
  - Art. 10.002.01.CO Ø 14
  - Art. 10.002.02.CO Ø 12
  - Art. 10.014.CO □ 14
  - Art. 10.014.01.CO □ 16
  - Art. 10.014.02.CO □ 12

Corteccia / *Bark model*  
H.950 mm

- Art. 10.040.15.CO □ 12
  - Art. 10.040.16.CO □ 14
  - Art. 10.040.17.CO □ 16
- H.1000 mm
- Art. 10.040.18.CO □ 12
  - Art. 10.040.19.CO □ 14
  - Art. 10.040.20.CO □ 16
- Rigato Martellato /  
*Fluted Hammered*  
H.950 mm
- Art. 10.040.15.RM □ 12
  - Art. 10.040.16.RM □ 14
  - Art. 10.040.17.RM □ 16

Corteccia / *Bark model*  
H.950 mm

- Art. 10.005.CO Ø 16
  - Art. 10.005.01.CO Ø 14
  - Art. 10.005.02.CO Ø 12
  - Art. 10.017.CO □ 14
  - Art. 10.017.01.CO □ 16
  - Art. 10.017.02.CO □ 12
- H.1000 mm
- Art. 10.006.CO Ø 16
  - Art. 10.006.01.CO Ø 14
  - Art. 10.006.02.CO Ø 12
  - Art. 10.018.CO □ 14
  - Art. 10.018.01.CO □ 16
  - Art. 10.018.02.CO □ 12

Corteccia / *Bark model*  
H.950 mm

- Art. 10.009.CO Ø 16
  - Art. 10.009.01.CO Ø 14
  - Art. 10.009.02.CO Ø 12
  - Art. 10.021.CO □ 14
  - Art. 10.021.01.CO □ 16
  - Art. 10.021.02.CO □ 12
- H.1000 mm
- Art. 10.010.CO Ø 16
  - Art. 10.010.01.CO Ø 14
  - Art. 10.010.02.CO Ø 12
  - Art. 10.022.CO □ 14
  - Art. 10.022.01.CO □ 16
  - Art. 10.022.02.CO □ 12

Corteccia / *Bark model*  
H.950 mm

- Art. 10.026.CO Ø 16
  - Art. 10.026.01.CO Ø 14
  - Art. 10.026.02.CO Ø 12
  - Art. 10.025.CO □ 14
  - Art. 10.025.01.CO □ 16
  - Art. 10.025.02.CO □ 12
- H.1000 mm
- Art. 10.028.CO Ø 16
  - Art. 10.028.01.CO Ø 14
  - Art. 10.028.02.CO Ø 12
  - Art. 10.027.CO □ 14
  - Art. 10.027.01.CO □ 16
  - Art. 10.027.02.CO □ 12

Corteccia / *Bark model*  
H.950 mm

- Art. 10.034.CO Ø 16
  - Art. 10.034.01.CO Ø 14
  - Art. 10.034.02.CO Ø 12
  - Art. 10.033.CO □ 14
  - Art. 10.033.01.CO □ 16
  - Art. 10.033.02.CO □ 12
- H.1000 mm
- Art. 10.036.CO Ø 16
  - Art. 10.036.01.CO Ø 14
  - Art. 10.036.02.CO Ø 12
  - Art. 10.035.CO □ 14
  - Art. 10.035.01.CO □ 16
  - Art. 10.035.02.CO □ 12

Rigato Martellato /  
*Fluted Hammered*  
H.950 mm

- Art. 10.013.RM □ 14
- Art. 10.013.01.RM □ 16
- Art. 10.013.02.RM □ 12

Rigato Martellato /  
*Fluted Hammered*  
H.950 mm

- Art. 10.017.RM □ 14
- Art. 10.017.01.RM □ 16
- Art. 10.017.02.RM □ 12

Rigato Martellato /  
*Fluted Hammered*  
H.950 mm

- Art. 10.021.RM □ 14
- Art. 10.021.01.RM □ 16
- Art. 10.021.02.RM □ 12

Rigato Martellato /  
*Fluted Hammered*  
H.950 mm

- Art. 10.025.RM □ 14
- Art. 10.025.01.RM □ 16
- Art. 10.025.02.RM □ 12

Rigato Martellato /  
*Fluted Hammered*  
H.950 mm

- Art. 10.033.RM □ 14
- Art. 10.033.01.RM □ 16
- Art. 10.033.02.RM □ 12



Tutte le parti di questo catalogo - foto comprese - sono di proprietà Euro-Fer. La riproduzione, anche parziale, è vietata in ogni forma e con ogni mezzo. / Every part of this catalogue - photos included - is Euro-Fer's property. All forms of copying are strictly prohibited.

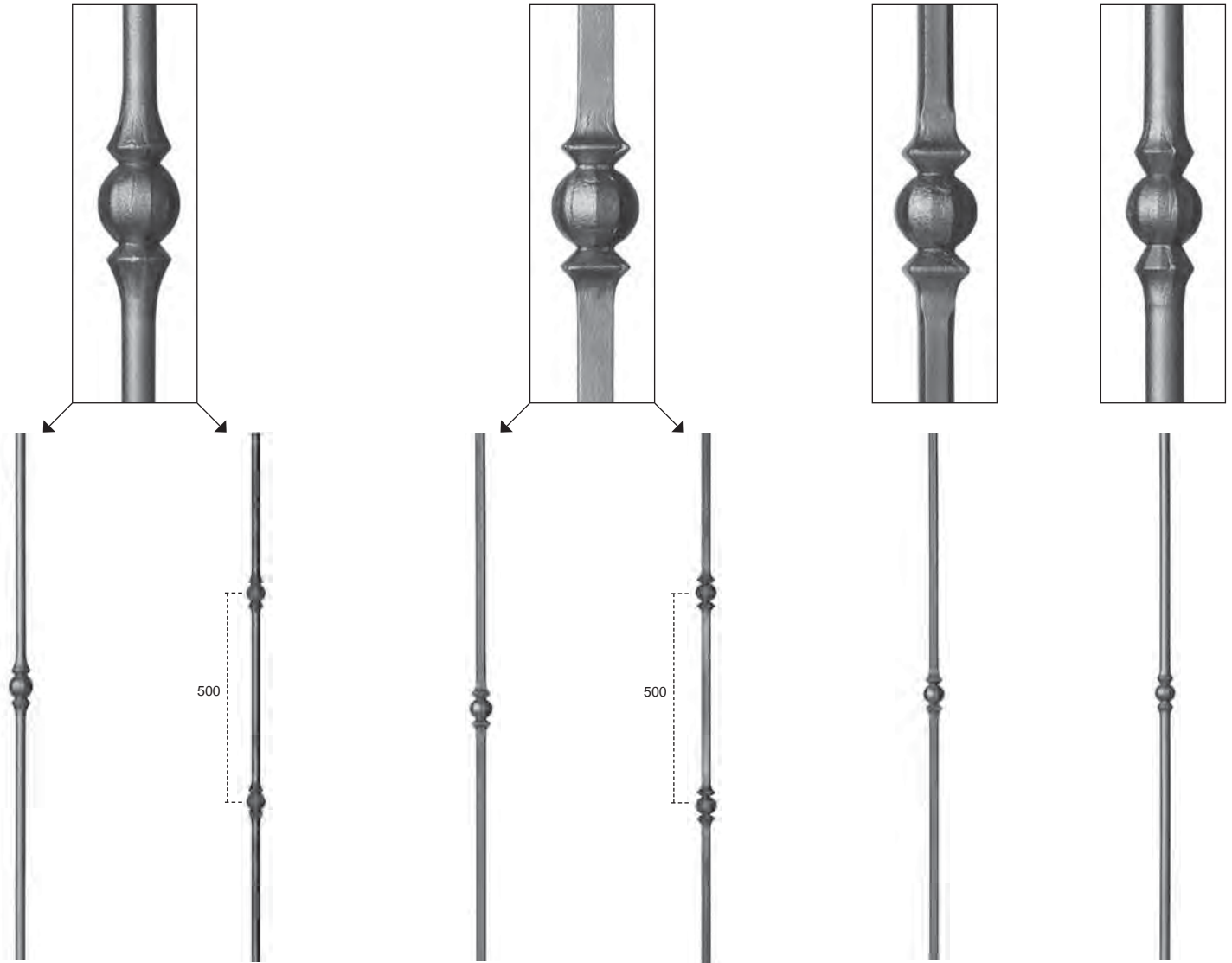

Art.11001L.T12.950  
Art.11001L.T12.1000  
Art.11001L.T12.1200  
Art.11001L.T12.1500

Art.11001.01L.T12.1000  
Art.11001.01L.T14.1000  
Art.11001.01L.T16.1000

Art.11001L.T14.950  
Art.11001L.T14.1000  
Art.11001L.T14.1200  
Art.11001L.T14.1500

Art.11001L.T16.950  
Art.11001L.T16.1000  
Art.11001L.T16.1200  
Art.11001L.T16.1500

Art.11002L.Q12.950  
Art.11002F.Q12.950  
Art.11002M.Q12.950

Art.11002L.Q12.1000  
Art.11002F.Q12.1000  
Art.11002M.Q12.1000  
Art.11002L.Q12.1200  
Art.11002F.Q12.1200  
Art.11002M.Q12.1200

Art.11002L.Q12.1500  
Art.11002F.Q12.1500  
Art.11002M.Q12.1500

Art.11002L.Q14.950  
Art.11002F.Q14.950  
Art.11002M.Q14.950

Art.11002L.Q14.1000  
Art.11002F.Q14.1000  
Art.11002M.Q14.1000

Art.11002L.Q14.1200  
Art.11002F.Q14.1200  
Art.11002M.Q14.1200

Art.11002L.Q14.1500  
Art.11002F.Q14.1500  
Art.11002M.Q14.1500

Art.11002L.Q16.950  
Art.11002L.Q16.1000  
Art.11002L.Q16.1200  
Art.11002L.Q16.1500

Art.11003L.Q12.1000  
Art.11003F.Q12.1000

Art.11003L.Q14.1000  
Art.11003F.Q14.1000

Art.11003L.Q16.1000

Art.11002S.Q12.950  
Art.11002S.Q12.1000  
Art.11002S.Q12.1200  
Art.11002S.Q12.1500

Art.11003.01L.T12.950  
Art.11003.01F.T12.950

Art.11003.01L.T12.1000  
Art.11003.01F.T12.1000

Art.11003.01L.T12.1200  
Art.11003.01F.T12.1200

Art.11003.01L.T12.1500  
Art.11003.01F.T12.1500

Art.11003.01L.T14.950  
Art.11003.01L.T14.1000  
Art.11003.01L.T14.1200  
Art.11003.01L.T14.1500

Legenda / Legend

- Q** QUADRO / SQUARE IRON
- T** TONDO / ROUND IRON
- F** FORGIATO / FORGED
- L** LISCIO / SMOOTH
- M** MARTELLATO / HAMMERED
- S** SMUSSATO / BLUNTED

Le misure sono in millimetri  
sizes are in mm

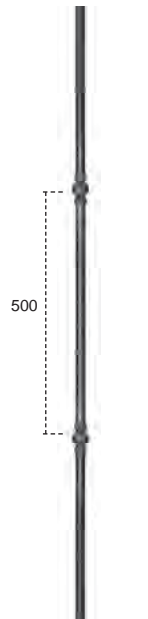

Art.11003.02L.T12.1000  
Art.11003.02F.T12.1000

Art. 11004L.Q12.1000  
Art. 11004L.Q12.1200  
Art. 11004F.Q12.1000  
Art. 11004F.Q12.1200

Art.11008L.Q12.950  
Art.11008F.Q12.950  
Art.11008M.Q12.950

Art.11008.01L.Q12.1000  
Art.11008.01F.Q12.1000  
Art.11008.01M.Q12.1000

Art.11008S.Q12.950  
Art.11008S.Q12.1000  
Art.11008S.Q12.1200  
Art.11008S.Q12.1500

Art.11008.04L.T12.950  
Art.11008.04L.T12.1000  
Art.11008.04L.T12.1200  
Art.11008.04L.T12.1500

Art.11008L.Q12.1000  
Art.11008F.Q12.1000  
Art.11008M.Q12.1000

Art.11008.01L.Q14.1000  
Art.11008.01F.Q14.1000  
Art.11008.01M.Q14.1000

Art.11008.04L.T14.950  
Art.11008.04L.T14.1000  
Art.11008.04L.T14.1200  
Art.11008.04L.T14.1500

Art.11008L.Q12.1200  
Art.11008F.Q12.1200  
Art.11008M.Q12.1200

Art.11008L.Q12.1500  
Art.11008F.Q12.1500  
Art.11008M.Q12.1500

Art.11008L.Q14.950  
Art.11008F.Q14.950  
Art.11008M.Q14.950  
Art.11008L.Q14.1000  
Art.11008F.Q14.1000  
Art.11008M.Q14.1000

Art.11008L.Q14.1200  
Art.11008F.Q14.1200  
Art.11008M.Q14.1200  
Art.11008L.Q14.1500  
Art.11008F.Q14.1500  
Art.11008M.Q14.1500

Legenda / Legend

**Q** QUADRO / SQUARE IRON

**T** TONDO / ROUND IRON

**F** FORGIATO / FORGED

**L** LISCIO / SMOOTH

**M** MARTELLATO / HAMMERED

**S** SMUSSATO / BLUNTED

Le misure sono in millimetri  
sizes are in mm

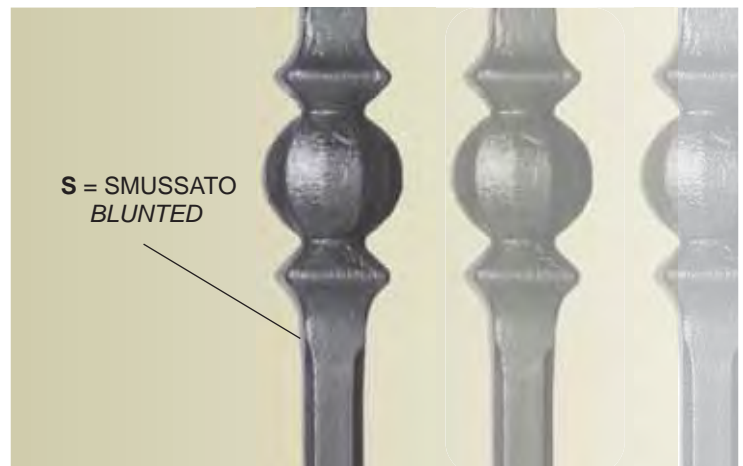





Art. 11014.10L.T12.1000  
Art. 11014.10L.T12.1200  
Art. 11014.10F.T12.1000  
Art. 11014.10F.T12.1200

Art.11017.03L.T12.950  
Art.11017.03F.T12.950  
  
Art.11017.03L.T12.1000  
Art.11017.03F.T12.1000

Art.11017.01L.T12.950  
Art.11017.01F.T12.950  
  
Art.11017.01L.T12.1000  
Art.11017.01F.T12.1000

Art.11023.04L.T.12.950  
Art.11023.04L.T12.1000  
Art.11023.04L.T12.1200  
Art.11023.04L.T12.1500

Art. 11041.36L.T12.1000  
Art. 11041.36L.T12.1200  
Art. 11041.36F.T12.1000  
Art. 11041.36F.T12.1200

Art.11017.03L.T12.1200  
Art.11017.03F.T12.1200

Art.11017.01L.T12.1200  
Art.11017.01F.T12.1200

Art.11017.03L.T12.1500  
Art.11017.03F.T12.1500

Art.11017.01L.T12.1500  
Art.11017.01F.T12.1500

Art.11017.05L.T14.950  
Art.11017.05L.T14.1000  
Art.11017.05L.T14.1200  
Art.11017.05L.T14.1500

Art.11017.01L.T14.950  
Art.11017.01F.T14.950

Art.11017.01L.T14.1000  
Art.11017.01F.T14.1000

Art.11017.01L.T14.1200  
Art.11017.01F.T14.1200

Art.11017.01L.T14.1500  
Art.11017.01F.T14.1500

Legenda  
Legend

**Q** QUADRO / SQUARE IRON

**T** TONDO / ROUND IRON

**F** FORGIATO / FORGED

**L** LISCIО / SMOOTH

**M** MARTELLATO / HAMMERED

**S** SMUSSATO / BLUNTED

Le misure sono in millimetri  
sizes are in mm



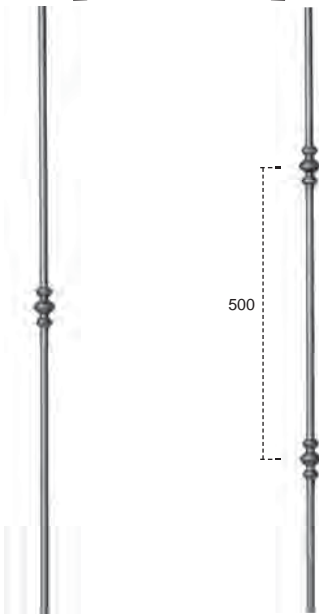

Art.11041.54L.Q12.950  
Art.11041.54L.T12.950

Art.11041.55L.Q12.1000  
Art.11041.55L.T12.1000

Art.11041.58L.T12.950  
Art.11041.58L.Q12.950

Art.11041.60L.Q12.950  
Art.11041.60L.Q12.1000

Art.11041.68L.T12.950  
Art.11041.68L.T12.1000

Art.11041.70L.Q14.950  
Art.11041.70L.Q14.1000  
Art.11041.70L.Q14.1200  
Art.11041.70L.Q14.1500

Art.11041.54L.Q12.1000  
Art.11041.54L.T12.1000

Art.11041.55L.Q14.1000  
Art.11041.55L.T14.1000

Art.11041.58L.T12.1000  
Art.11041.58L.Q12.1000

Art.11041.58L.T12.1200  
Art.11041.58L.Q12.1200

Art.11041.54L.Q12.1200  
Art.11041.54L.T12.1200

Art.11041.54L.Q12.1500  
Art.11041.54L.T12.1500

Art.11041.58L.T12.1500  
Art.11041.58L.Q12.1500

Art.11041.54L.Q14.950  
Art.11041.54L.T14.950

Art.11041.58L.T14.1000  
Art.11041.58L.Q14.1000

Art.11041.54L.Q14.1000  
Art.11041.54L.T14.1000

Art.11041.54L.Q14.1200  
Art.11041.54L.T14.1200

Art.11041.54L.Q14.1500  
Art.11041.54L.T14.1500

**SU RICHIESTA / ON REQUEST**

Tutti gli articoli di questo catalogo possono essere realizzati con queste lance / All articles in this catalogue can be realized with these spears.

**P**  
PALLINA PICCOLA  
SMALL BALL



**PP**  
PUNTA A PIRAMIDE  
PYRAMIDAL END



**CT**  
CODA DI TOPO  
TAIL END



**A**  
FIAMMA  
FLAME



**AP**  
FIAMMA E PALLINA GRANDE  
FLAME AND BIG BALL



Per ordinare i paletti seguire l'esempio  
To order bars please follow the example:

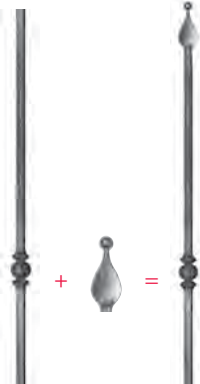

11002L.Q12.950 + AP = 11002L.Q12.950AP

Tutte le parti di questo catalogo - foto comprese - sono di proprietà Euro-Fer. La riproduzione, anche parziale, è vietata in ogni forma e con ogni mezzo. / Every part of this catalogue - photos included - is Euro-Fer's property. All forms of copying are strictly prohibited.



SU RICHIESTA / ON REQUEST

Tutti gli articoli di questo catalogo possono essere realizzati con queste lance / All articles in this catalogue can be realized with these spears.



P = PALLINA PICCOLA / SMALL BALL



A = FIAMMA/FLAME



AP = FIAMMA E PALLINA GRANDE / FLAME AND BIG BALL



PP = PUNTA A PIRAMIDE / PYRAMIDAL END



CT = CODA DI TOPO / TAIL END

Per ordinare i paletti seguire l'esempio / To order bars please follow the example:

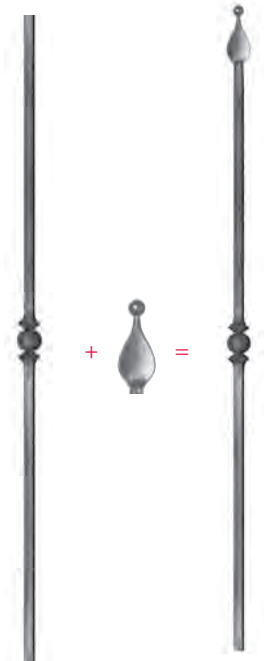

11002L.Q12.950 + AP = 11002L.Q12.950AP



Art.11098.02L.Q14.950  
Art.11098.02L.Q14.1200  
Art.11098.02L.Q14.1500  
Art.11098.02L.Q14.1800



Art.11098.04L.T12.950  
Art.11098.04L.T12.1200  
Art.11098.04L.T12.1500  
Art.11098.04L.T12.1800



Art.11090.01L.Q12.1000  
Art.11090.01L.Q12.1200  
Art.11090.01L.Q12.1500  
Art.11090.01L.Q12.1800



Art.11091.01L.T12.1000  
Art.11091.01L.T12.1200  
Art.11091.01L.T12.1500  
Art.11091.01L.T12.1800

Legenda / Legend

- Q** QUADRO / SQUARE IRON
- T** TONDO / ROUND IRON
- F** FORGIATO / FORGED
- L** LISCIO / SMOOTH
- M** MARTELLATO / HAMMERED
- S** SMUSSATO / BLUNTED

Le misure sono in millimetri / sizes are in mm





## *I forgiati italiani*

Il Forgiato Italiano, la ricerca della qualità assoluta.

EUROFER evolve il classico paletto forgiato standard e crea il FORGIATO ITALIANO.

Con il FORGIATO ITALIANO puoi scegliere la misura, la texture, il decoro.

È fatto interamente in Italia e ti consente di inserire il motivo in ferro forgiato su un paletto liscio, martellato o smussato.

## *Forged bars made in Italy*

The ITALIAN FORGED BARS: the pursuit of absolute quality.

EUROFER evolves the classic standard forged bollard and creates the ITALIAN FORGED BAR. With the ITALIAN FORGED BAR you can choose the size, the texture, the decor and the tip. It's made entirely in Italy and allows you to insert the forged iron motif on a smooth, hammered or beveled stake.



Art. 11002P.Q12.950  
Art. 11002P.Q12.1000  
Art. 11002P.Q12.1200  
Art. 11002P.Q12.1500  
Art. 11002P.Q12.3000  
Art. 11002P.Q12.6000



Art. 11002P.Q14.950  
Art. 11002P.Q14.1000  
Art. 11002P.Q14.1200  
Art. 11002P.Q14.1500  
Art. 11002P.Q14.3000  
Art. 11002P.Q14.6000



Art. 11017.01P.T12.950  
Art. 11017.01P.T12.1000  
Art. 11017.01P.T12.1200  
Art. 11017.01P.T12.1500  
Art. 11017.01P.T12.3000  
Art. 11017.01P.T12.6000



Art. 11017.01P.T14.950  
Art. 11017.01P.T14.1000  
Art. 11017.01P.T14.1200  
Art. 11017.01P.T14.1500  
Art. 11017.01P.T14.3000  
Art. 11017.01P.T14.6000

ELEMENTI IN FERRO FORGIATO E CAPISALDI  
FORGED BARS AND POSTS



H.1000 mm.  
Art. 11.001  
Ø 14 circa



H.1000 mm.  
Art. 11.001.01  
Ø 14 circa



H.1000mm.  
Art. 11.002.P □ 14 ca.  
Art. 11.002.D.P □ 12 ca.



H.1000 mm.  
Art. 11.002 □ 14 circa  
Art. 11.002.E □ 10 circa  
Art. 11.002.D □ 12 circa



H.1000 mm.  
Art. 11.003 □ 14 circa  
Art. 11.003.E □ 10 circa  
Art. 11.003.D □ 12 circa



Rastrematō / Tapered  
H.1000 mm.  
Art. 11.003.01.P  
Ø 14 circa

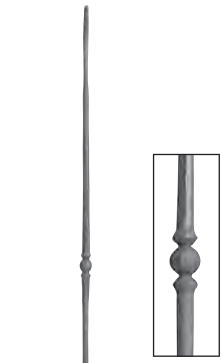

H.1000 mm.  
Art. 11.003.01  
Ø 14 circa  
Art. 11.003.01.E  
Ø 12 circa



H.1000 mm.  
Art. 11.003.02  
Ø 14 circa  
Art. 11.003.02.E  
Ø 12 circa



H.1000 mm.  
Art. 11.003.03  
Ø 14 circa

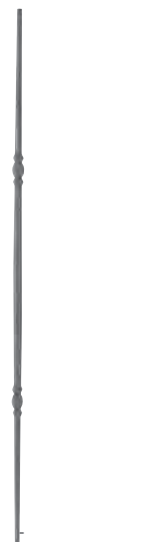

H.1000 mm.  
Art. 11.003.04  
Ø 14 circa

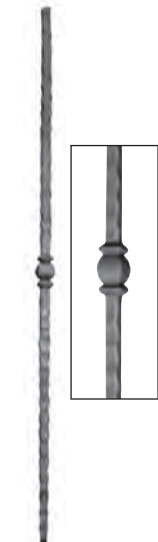

H.1000 mm.  
Art. 11.004  
□ 14 circa

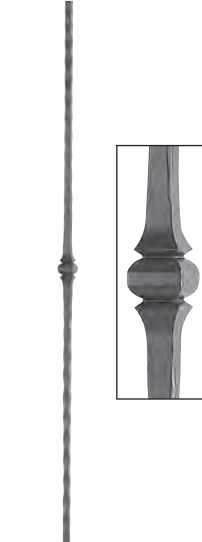

H.1000 mm.  
Art. 11.004.01  
□ 14 circa



H.1000 mm.  
Art. 11.004.02  
□ 14 circa

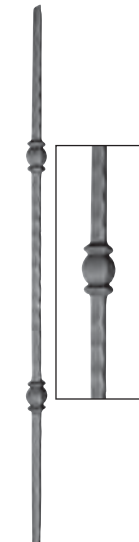

H.1000 mm.  
Art. 11.005  
□ 14 circa

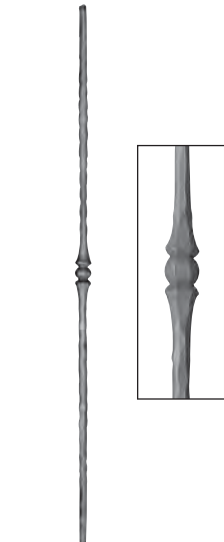

H.1000 mm.  
Art. 11.006  
□ 14 circa  
Art. 11.006.01  
Ø 14 circa

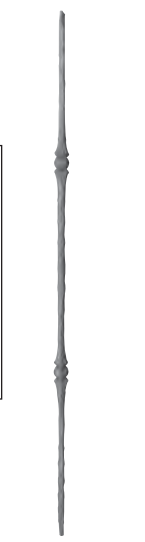

H.1000 mm.  
Art. 11.007  
□ 14 circa  
Art. 11.007.01  
Ø 14 circa

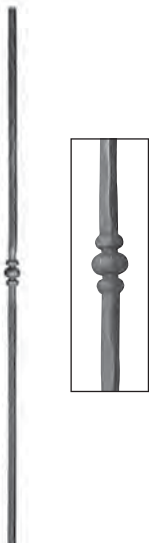

H.1000 mm.  
Art. 11.008  
□ 14 circa



H.1000 mm.  
Art. 11.008.01  
□ 14 circa



H.1000 mm.  
Art. 11.008.02  
Ø 14 circa



H.1000 mm.  
Art. 11.008.03  
Ø 14 circa



H.1000 mm.  
Art. 11.008.04  
Ø 12 circa



H.1000 mm.  
Art. 11.008.05  
Ø 12 circa



H.1000 mm.  
Art. 11.008.06  
□ 12 circa

Smussato / Blunted



H.1000 mm.  
Art. 11.008.07  
□ 12 circa

Smussato / Blunted

Tutte le parti di questo catalogo - foto comprese - sono di proprietà Euro-Fer. La riproduzione, anche parziale, è vietata in ogni forma e con ogni mezzo. / Every part of this catalogue - photos included - is Euro-Fer's property. All forms of copying are strictly prohibited.

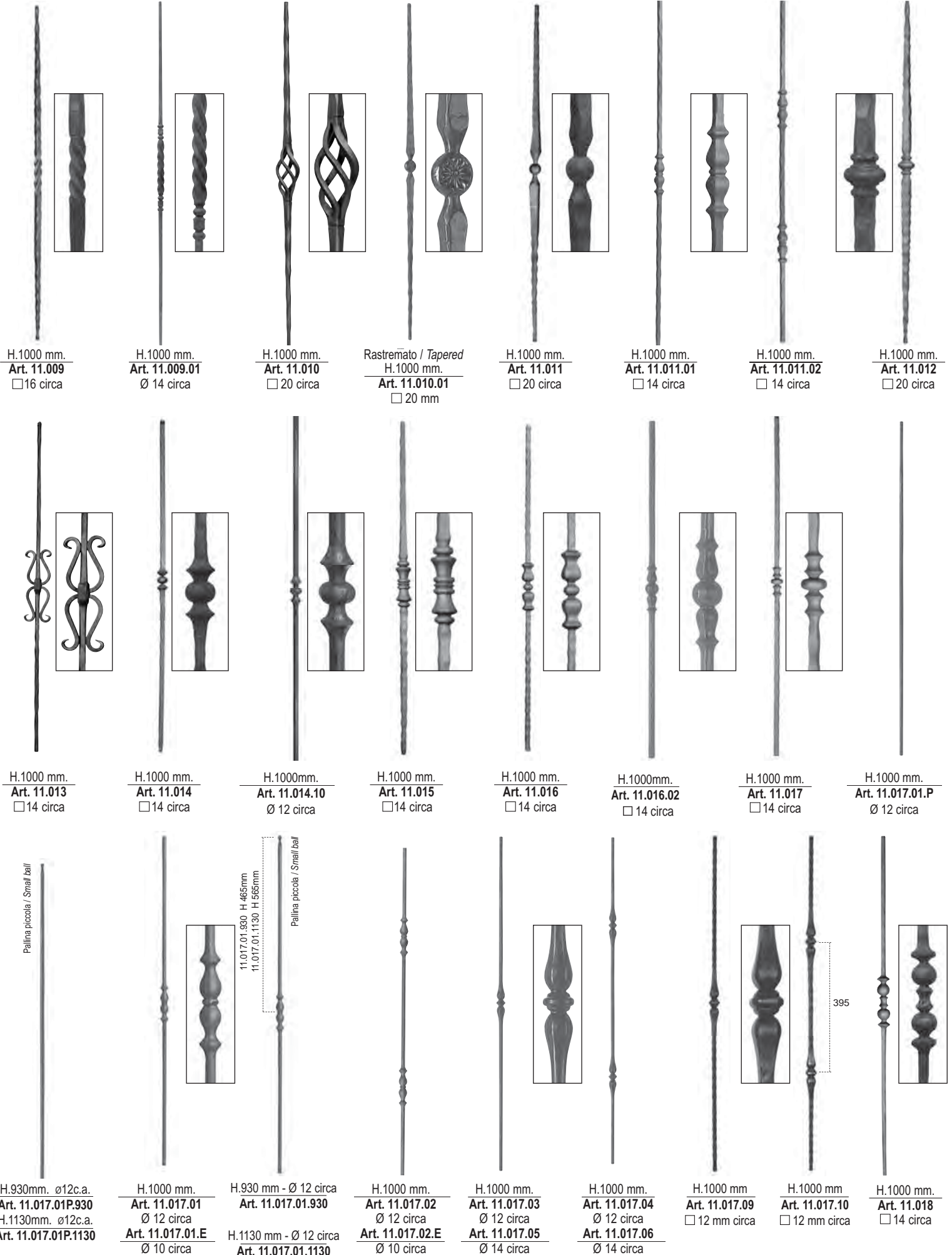

H.1000 mm. Art. 11.009 □ 16 circa  
 H.1000 mm. Art. 11.009.01 □ 14 circa  
 H.1000 mm. Art. 11.010 □ 20 circa  
 Rastremato / Tapered H.1000 mm. Art. 11.010.01 □ 20 mm  
 H.1000 mm. Art. 11.011 □ 20 circa  
 H.1000 mm. Art. 11.011.01 □ 14 circa  
 H.1000 mm. Art. 11.011.02 □ 14 circa  
 H.1000 mm. Art. 11.012 □ 20 circa

H.1000 mm. Art. 11.013 □ 14 circa  
 H.1000 mm. Art. 11.014 □ 14 circa  
 H.1000mm. Art. 11.014.10 □ 12 circa  
 H.1000 mm. Art. 11.015 □ 14 circa  
 H.1000 mm. Art. 11.016 □ 14 circa  
 H.1000mm. Art. 11.016.02 □ 14 circa  
 H.1000 mm. Art. 11.017 □ 14 circa  
 H.1000 mm. Art. 11.017.01.P □ 12 circa

H.930mm. ø12c.a. Art. 11.017.01P.930  
 H.1130mm. ø12c.a. Art. 11.017.01P.1130  
 H.1000 mm. Art. 11.017.01 □ 12 circa  
 H.1000 mm. Art. 11.017.01.E □ 10 circa  
 H.930 mm - Ø 12 circa Art. 11.017.01.930  
 H.1130 mm - Ø 12 circa Art. 11.017.01.1130  
 H.1000 mm. Art. 11.017.02 □ 12 circa  
 H.1000 mm. Art. 11.017.02.E □ 10 circa  
 H.1000 mm. Art. 11.017.03 □ 12 circa  
 H.1000 mm. Art. 11.017.05 □ 14 circa  
 H.1000 mm. Art. 11.017.04 □ 12 circa  
 H.1000 mm. Art. 11.017.06 □ 14 circa  
 H.1000 mm Art. 11.017.09 □ 12 mm circa  
 H.1000 mm Art. 11.017.10 □ 12 mm circa  
 H.1000 mm. Art. 11.018 □ 14 circa



ELEMENTI IN FERRO FORGIATO E CAPISALDI  
FORGED BARS AND POSTS

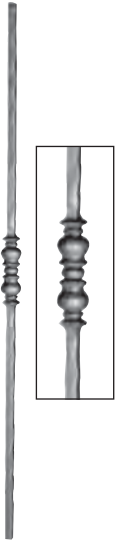

H.1000 mm.  
Art. 11.019  
□ 14 circa



H.1000 mm.  
Art. 11.019.01  
Ø 14 mm



H.1000 mm.  
Art. 11.020  
□ 14 circa

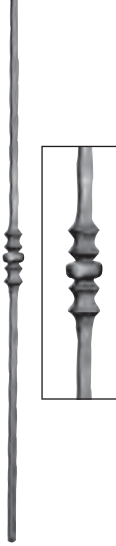

H.1000 mm.  
Art. 11.021  
□ 14 circa



H.1000 mm.  
Art. 11.021.01  
□ 14 circa



H.1000 mm.  
Art. 11.022  
□ 14 circa



Art. 11.023



H.1000 mm.  
Art. 11.023.01  
□ 20 circa

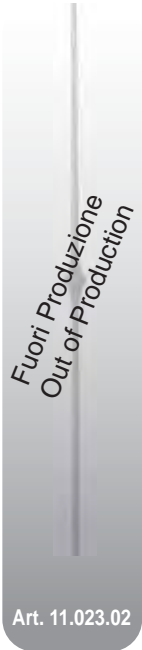

Art. 11.023.02

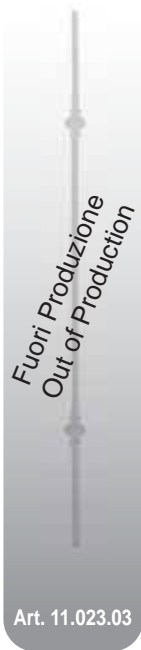

Art. 11.023.03



H.1000 mm.  
Art. 11.023.04  
Ø 14 mm



H.1000 mm.  
Art. 11.023.05  
Ø 14 mm



H.1000 mm.  
Art. 11.024  
□ 14 circa



H.1000 mm.  
Art. 11.025  
□ 14 circa



H.1000 mm.  
Art. 11.026



H.1000 mm.  
Art. 11.027



H.1000 mm.  
Art. 11.028



H.1000 mm.  
Art. 11.029  
□ 14 circa



H.1000 mm.  
Art. 11.030  
□ 14 circa



H.1000 mm.  
Art. 11.031  
□ 14 circa



H.1000 mm.  
Art. 11.032  
□ 14 circa



H.1000 mm.  
Art. 11.033  
□ 14 circa



H.1000 mm.  
Art. 11.034  
□ 14 circa



H.1000 mm.  
Art. 11.035  
□ 14 circa



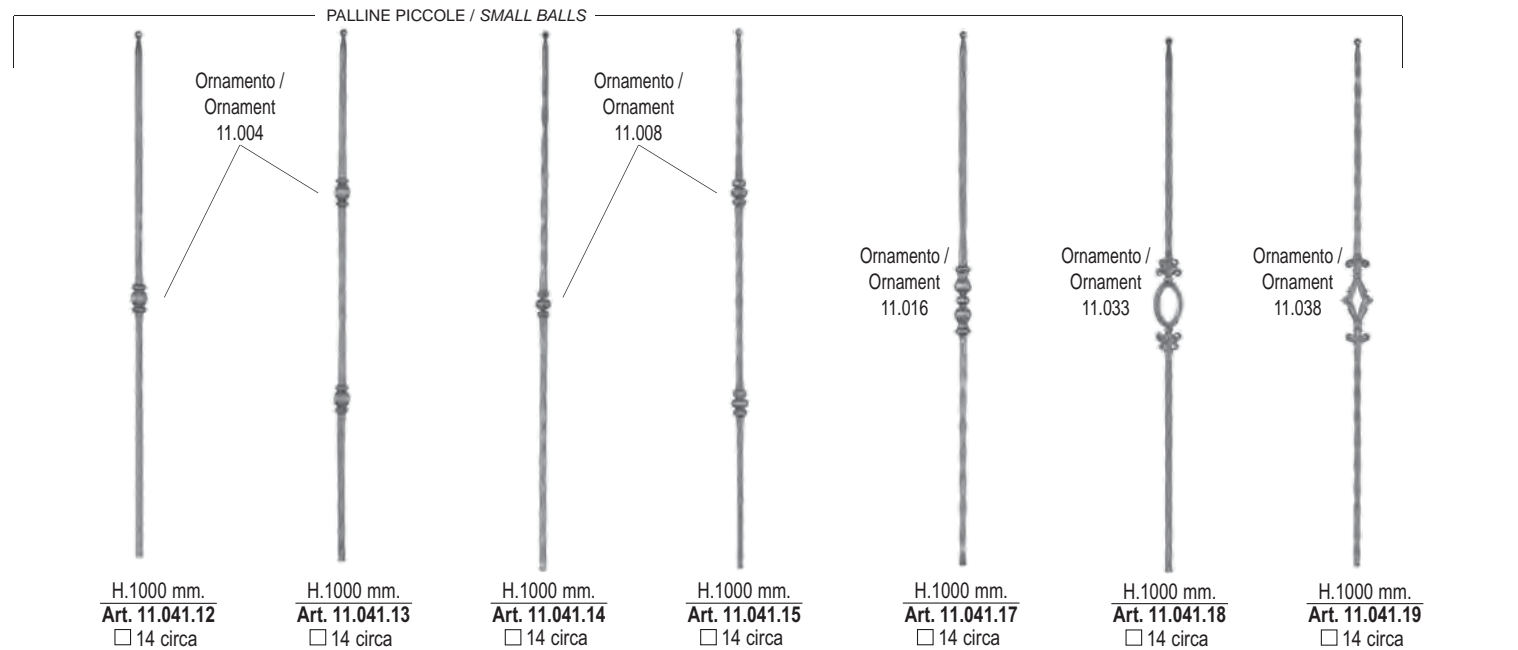
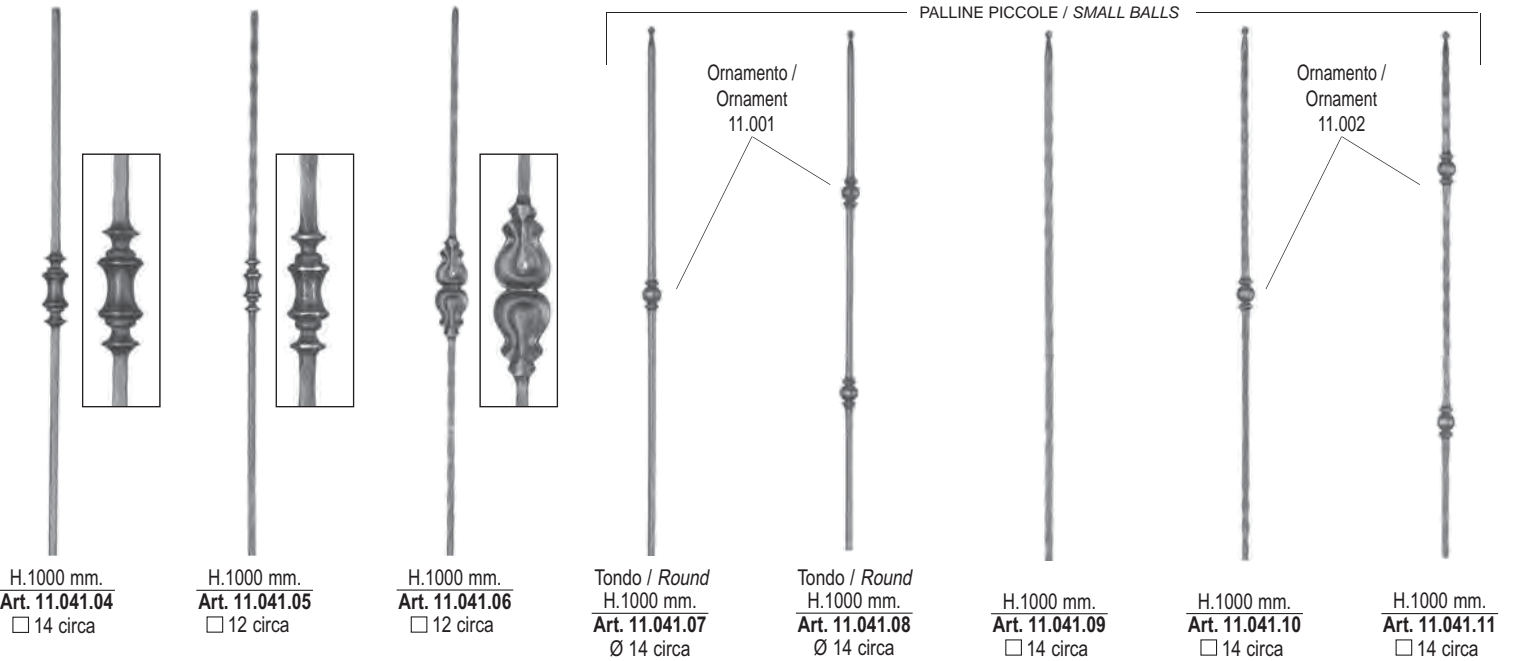
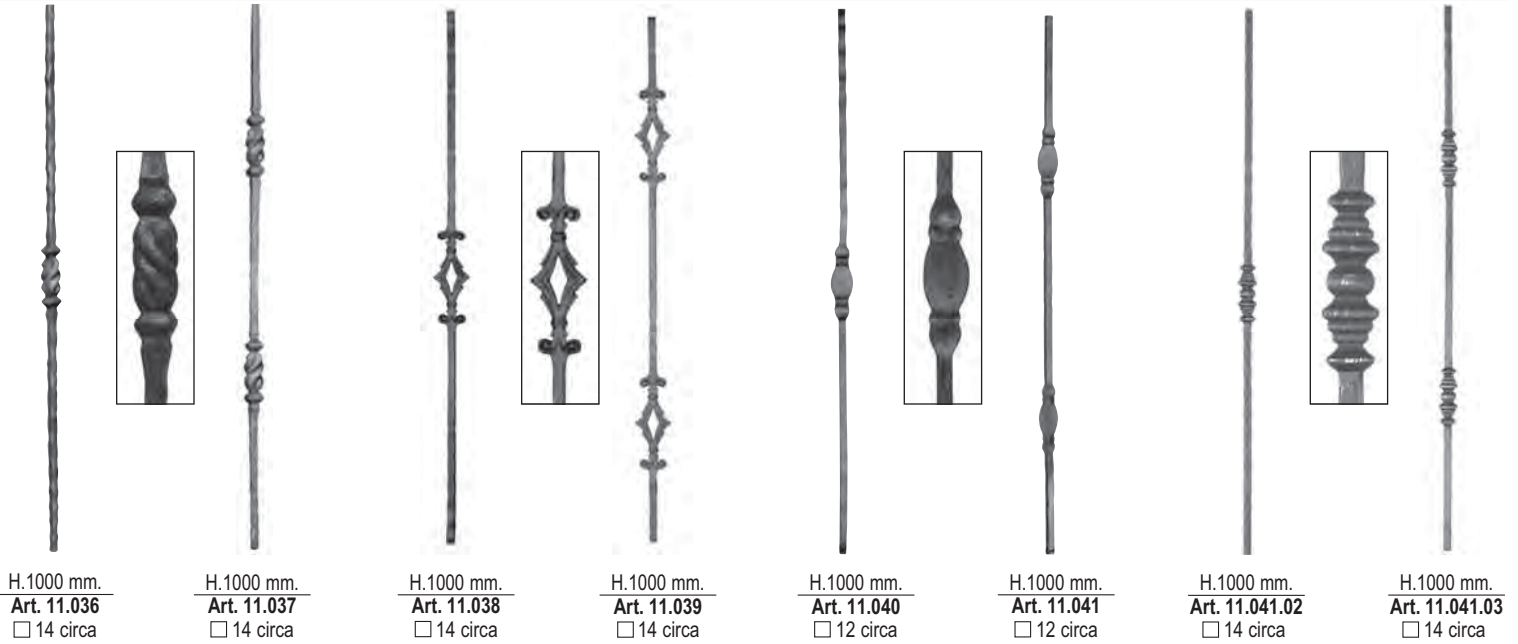



Tutte le parti di questo catalogo - foto comprese - sono di proprietà Euro-Fer. La riproduzione, anche parziale, è vietata in ogni forma e con ogni mezzo. / Every part of this catalogue - photos included - is Euro-Fer's property. All forms of copying are strictly prohibited.











Tutte le parti di questo catalogo - foto comprese - sono di proprietà Euro-Fer. La riproduzione, anche parziale, è vietata in ogni forma e con ogni mezzo. / Every part of this catalogue - photos included - is Euro-Fer's property. All forms of copying are strictly prohibited.



PALLINE PICCOLE / SMALL BALLS

					
Ornamento / Ornament 11.001	Ornamento / Ornament 11.002	Ornamento / Ornament 11.004	Ornamento / Ornament 11.004	Ornamento / Ornament 11.008	Ornamento / Ornament 11.008
Tondo / Round H.1000 mm. Art. 11.041.21 Ø 14 circa	H.1000 mm. Art. 11.041.23 □ 14 circa	H.1000 mm. Art. 11.041.25 □ 14 circa	H.1000 mm. Art. 11.041.26 □ 14 circa	H.1000 mm. Art. 11.041.27 □ 14 circa	H.1000 mm. Art. 11.041.28 □ 14 circa

PALLINE PICCOLE / SMALL BALLS

							
Ornamento / Ornament 11.019	Ornamento / Ornament 11.016	Ornamento / Ornament 11.033	Ornamento / Ornament 11.038				
H.1000 mm. Art. 11.041.29 □ 14 circa	H.1000 mm. Art. 11.041.30 □ 14 circa	H.1000 mm. Art. 11.041.31 □ 14 circa	H.1000 mm. Art. 11.041.32 □ 14 circa	H.1000 mm. Art. 11.041.33 Ø 14 circa	H.1000 mm. Art. 11.041.34 Ø 14 circa	H.1000 mm. Art. 11.041.35 Ø 14 circa	H.1000 mm. Art. 11.041.35 Ø 14 circa

Tutte le parti di questo catalogo - foto comprese - sono di proprietà Euro-Fer. La riproduzione, anche parziale, è vietata in ogni forma e con ogni mezzo. / Every part of this catalogue - photos included - is Euro-Fer's property. All forms of copying are strictly prohibited.



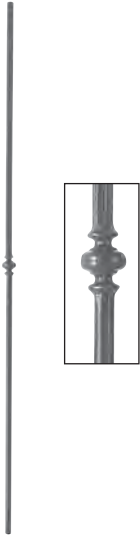

H.1000 mm.  
Art. 11.041.36  
Ø 12 mm circa



H.1000 mm.  
Art. 11.041.37  
Ø 12 mm circa



H.1000 mm.  
Art. 11.041.38  
□ 14 circa



H. 1000 mm  
Art. 11.041.39  
Ø 12 mm circa



H.1000 mm.  
Art. 11.041.40  
□ 14 mm circa

Fuori Produzione  
Out of Production

Art. 11.041.41



H.1000 mm.  
Art. 11.041.42  
Ø 14 mm circa

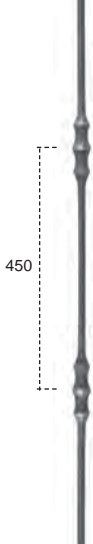

H.1000 mm.  
Art. 11.041.43  
Ø 14 mm circa

450



H.1000 mm.  
Art. 11.041.44  
Ø 14 mm circa



H.1000 mm.  
Art. 11.041.45  
Ø 14 mm circa

400



H.1000 mm.  
Art. 11.041.46  
□ 14 mm circa



H.1000 mm.  
Art. 11.041.47  
Ø 14 mm circa



H.1000 mm.  
Art. 11.041.48  
Ø 14 mm circa



H.1000 mm.  
Art. 11.041.49  
Ø 14 mm circa

310

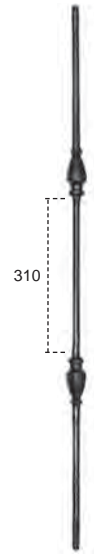

H.1000 mm.  
Art. 11.041.50  
Ø 14 mm circa

310

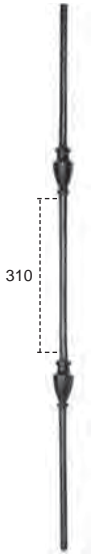

H.1000 mm.  
Art. 11.041.51  
Ø 14 mm circa

310



H.1000 mm  
Art. 11.041.52  
□ 12 mm ca.



H.1000 mm  
Art. 11.041.53  
□ 12 mm ca.

360



H.1000 mm  
Art. 11.041.54  
Ø 12 mm ca.

490



H.1000 mm  
Art. 11.041.55  
Ø 12 mm ca.



H.1000 mm  
Art. 11.041.68 Ø 12 ca.  
Art. 11.041.69 Ø 14 ca.



H.1000 mm  
Art. 11.041.70  
□ 14 mm ca.

Smussato / Blunted

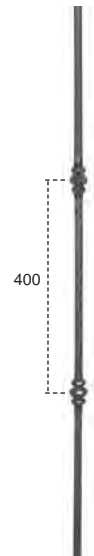

H.1000 mm  
Art. 11.041.71  
□ 14 mm ca.

400

Smussato / Blunted

Tutte le parti di questo catalogo - foto comprese - sono di proprietà Euro-Fer. La riproduzione, anche parziale, è vietata in ogni forma e con ogni mezzo. / Every part of this catalogue - photos included - is Euro-Fer's property. All forms of copying are strictly prohibited.

ELEMENTI IN FERRO FORGIATO E CAPISALDI  
FORGED BARS AND POSTS



H.1000 mm  
Art. 11.041.72  
□ 12 mm ca.

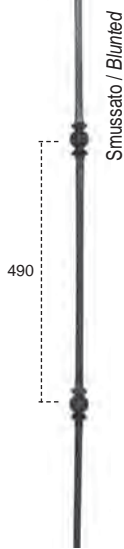

H.1000 mm  
Art. 11.041.73  
□ 12 mm ca.



H.1000 x L.120 mm  
Art. 11.041.79  
□ 14 mm ca.

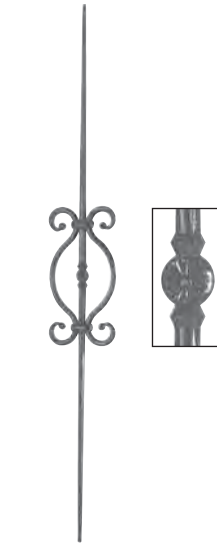

H.1000 X L.135. mm  
Art. 11.041.80  
Ø 14 mm circa



H.1000 X L.135 mm  
Art. 11.041.81  
Ø 14 mm circa

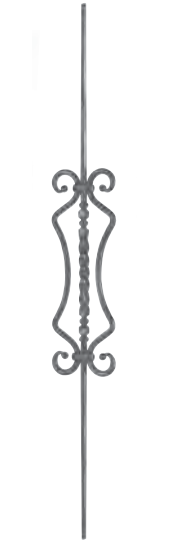

H.1000 X L.135 mm.  
Art. 11.041.82  
Ø 14 mm circa



H.1000 X L.135 mm.  
Art. 11.041.83  
Ø 12 mm circa



H.1000 X L.125 mm.  
Art. 11.041.84  
□ 14 mm circa



H.1000 X L.125 mm.  
Art. 11.041.85  
Ø 14 mm circa



H.1000 X L.125 mm.  
Art. 11.041.86  
□ 14 mm circa



Liscio / Smooth  
H. 1000 mm  
Art. 11.041.100 Ø 12 c.a.



Fuori Produzione  
Out of Production

Art. 11.041.104



Fuori Produzione  
Out of Production

Art. 11.041.105



Fuori Produzione  
Out of Production

Art. 11.041.108



Forgiato / Forged  
H.1000 mm  
Art. 11.041.109 Ø 12 ca.



Fuori Produzione  
Out of Production

Art. 11.041.110

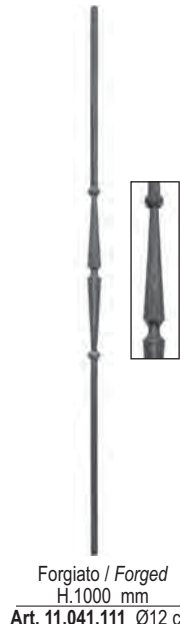

Forgiato / Forged  
H.1000 mm  
Art. 11.041.111 Ø12 ca.



Forgiato / Forged  
H.1000 mm  
Art. 11.041.113 Ø12 ca.

Tutte le parti di questo catalogo - foto comprese - sono di proprietà Euro-Fer. La riproduzione, anche parziale, è vietata in ogni forma e con ogni mezzo. / Every part of this catalogue - photos included - is Euro-Fer's property. All forms of copying are strictly prohibited.

Fuori Produzione  
Out of Production

Art. 11.041.115



Smussato / Blunted  
H.1000 mm  
Art. 11.041.118 □ 13 ca



Battuto / Beaten  
H.1100 mm.  
Art. 11.042 □ 20



Battuto / Beaten  
H.1100 mm.  
Art. 11.043 □ 25  
Art. 11.044 □ 30



H.1100 mm.  
Art. 11.044.01 □ 20



H.1100 mm.  
Art. 11.044.02 □ 25  
Art. 11.044.03 □ 30



H.1100 mm.  
Art. 11.044.04 □ 20



H.1100 mm.  
Art. 11.044.04 □ 20  
Art. 11.044.05 □ 25  
Art. 11.044.06 □ 30



H.1200 mm.  
Art. 11.044.07 □ 20  
Art. 11.044.08 □ 25  
Art. 11.044.09 □ 30

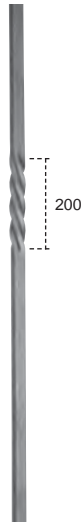

In Spigolo / Edged Bar  
H.1200 mm.  
Art. 11.045 □ 25  
Art. 11.046 □ 30



H.1100 mm.  
Art. 11.047 □ 20  
Art. 11.048 □ 25  
Art. 11.049 □ 30



Martellato / Hammered  
H.1100 mm.  
Art. 11.049.01 □ 20  
Art. 11.049.02 □ 25  
Art. 11.049.03 □ 30



Liscio / Smooth  
H.1200 mm  
Art. 11.049.08  
Ø 25 circa

Fuori Produzione  
Out of Production

Art. 11.049.11

Fuori Produzione  
Out of Production

Art. 11.049.12



In Spigolo / Edged Bar  
H.1200 mm.  
Art. 11.050 □ 25  
Art. 11.051 □ 30



Martellato / Hammered  
H.1100 mm.  
Art. 11.052 □ 20  
Art. 11.052.01 □ 25  
Art. 11.052.02 □ 30



H.1100 mm.  
Art. 11.053 □ 20  
Art. 11.053.01 □ 25  
Art. 11.053.02 □ 30



H.1200 mm.  
Art. 11.053.03 □ 25  
Art. 11.053.04 □ 30



H.1200 mm.  
Art. 11.053.05 □ 25  
Art. 11.053.06 □ 30

Tutte le parti di questo catalogo - foto comprese - sono di proprietà Euro-Fer. La riproduzione, anche parziale, è vietata in ogni forma e con ogni mezzo. / Every part of this catalogue - photos included - is Euro-Fer's property. All forms of copying are strictly prohibited.





Martellato / Hammered  
H.1200 mm.  
Art. 11.053.07 □ 25  
Art. 11.053.08 □ 30

Tondo / Round  
H.1200 mm.  
Art. 11.053.09 Ø 25  
Art. 11.053.10 Ø 30

H.1200 mm.  
Art. 11.053.11 □ 25  
Art. 11.053.12 □ 30



Martellato / Hammered  
H.1200 mm.  
Art. 11.053.13 □ 25  
Art. 11.053.14 □ 30

Tondo / Round  
H.1200 mm.  
Art. 11.053.15 Ø 25  
Art. 11.053.16 Ø 30

H.1200 mm.  
Art. 11.053.17 □ 20  
Art. 11.053.18 □ 25  
Art. 11.053.19 □ 30

Martellato / Hammered  
H.1200 mm.  
Art. 11.053.20 □ 20  
Art. 11.053.21 □ 25  
Art. 11.053.22 □ 30

Tondo / Round  
H.1200 mm.  
Art. 11.053.23 Ø 25  
Art. 11.053.24 Ø 30

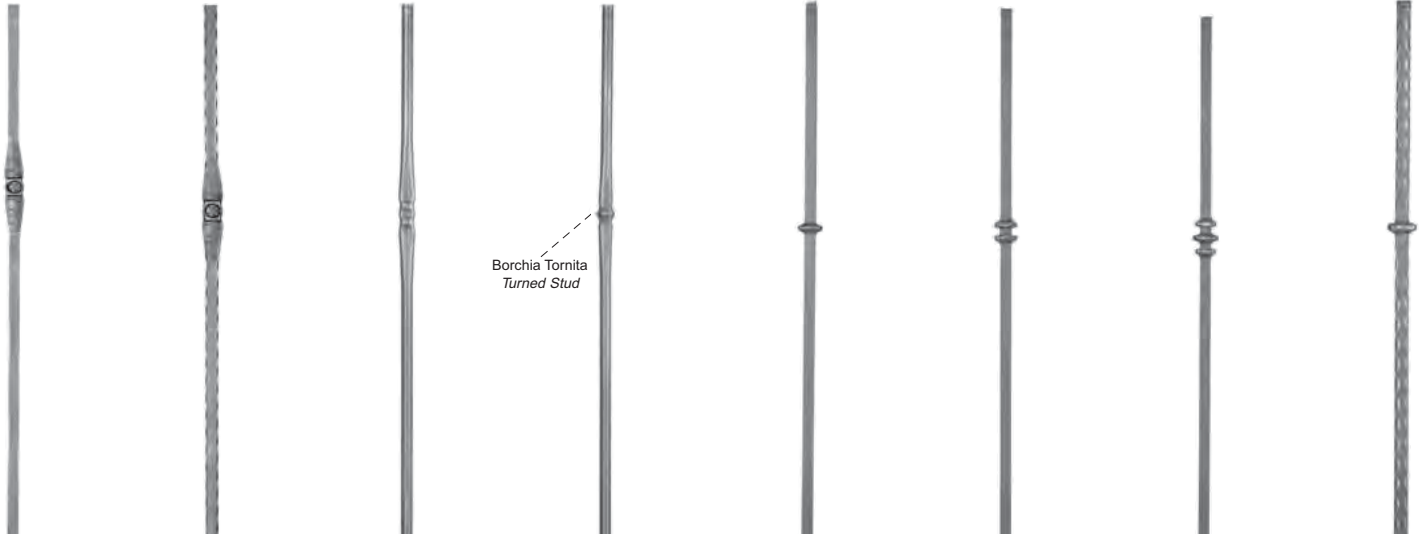

Borchia Tornita  
Turned Stud

H.1200 mm.  
Art. 11.053.25 □ 25  
Art. 11.053.26 □ 30

Martellato / Hammered  
H.1200 mm.  
Art. 11.053.27 □ 25  
Art. 11.053.28 □ 30

Tondo / Round  
H.1200 mm.  
Art. 11.053.29 Ø 25

Tondo / Round  
H.1200 mm.  
Art. 11.053.30 Ø 25

H.1200 mm.  
Art. 11.053.31 □ 25  
Art. 11.053.32 □ 30

H.1200 mm.  
Art. 11.053.33 □ 25  
Art. 11.053.34 □ 30

H.1200 mm.  
Art. 11.053.35 □ 25  
Art. 11.053.36 □ 30

Martellato / Hammered  
H.1200 mm.  
Art. 11.053.37 □ 25  
Art. 11.053.38 □ 30

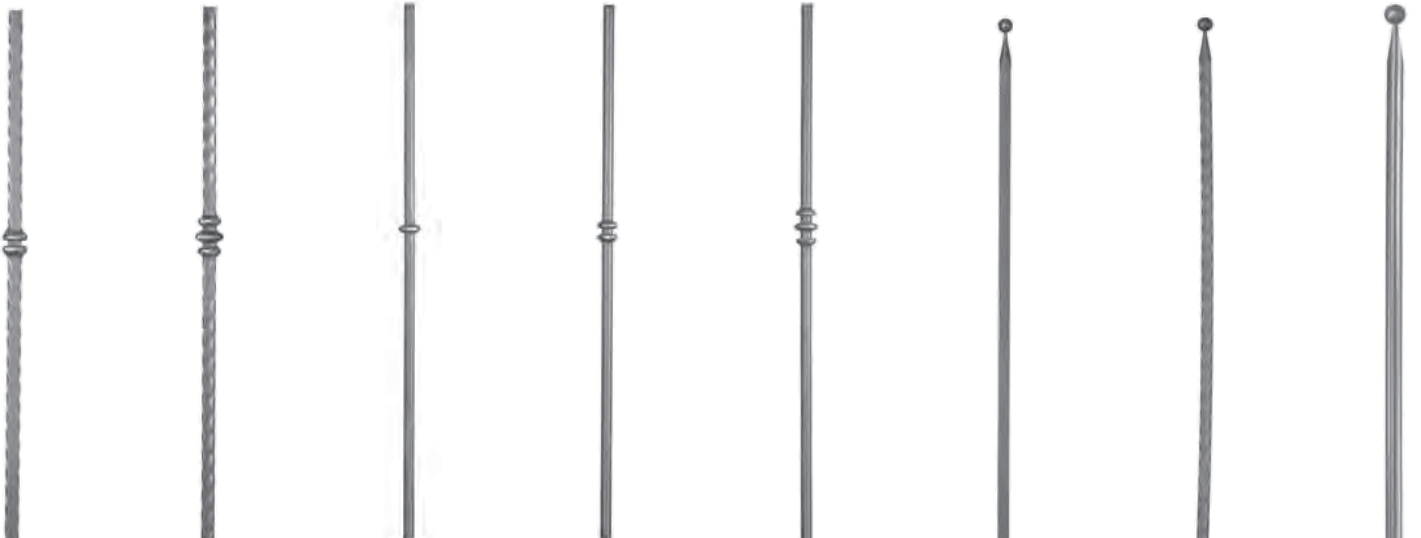

Martellato / Hammered  
H.1200 mm.  
Art. 11.053.39 □ 25  
Art. 11.053.40 □ 30

Martellato / Hammered  
H.1200 mm.  
Art. 11.053.41 □ 25  
Art. 11.053.42 □ 30

Tondo / Round  
H.1200 mm.  
Art. 11.053.43 Ø 25  
Art. 11.053.44 Ø 30

Tondo / Round  
H.1200 mm.  
Art. 11.053.45 Ø 25  
Art. 11.053.46 Ø 30

Tondo / Round  
H.1200 mm.  
Art. 11.053.47 Ø 25  
Art. 11.053.48 Ø 30

H.1200 mm.  
Art. 11.053.49 □ 25  
Art. 11.053.50 □ 30

Martellato / Hammered  
H.1200 mm.  
Art. 11.053.51 □ 25  
Art. 11.053.52 □ 30

Tondo / Round  
H.1200 mm.  
Art. 11.053.53 Ø 25  
Art. 11.053.54 Ø 30

Tutte le parti di questo catalogo - foto comprese - sono di proprietà Euro-Fer. La riproduzione, anche parziale, è vietata in ogni forma e con ogni mezzo. / Every part of this catalogue - photos included - is Euro-Fer's property. All forms of copying are strictly prohibited.



H.1200 mm.  
Art. 11.053.55 □ 25  
Art. 11.053.56 □ 30

Martellato / *Hammered*  
H.1200 mm.  
Art. 11.053.57 □ 25  
Art. 11.053.58 □ 30

Tondo / *Round*  
H.1200 mm.  
Art. 11.053.59 Ø 25  
Art. 11.053.60 Ø 30

H.1200 mm.  
Art. 11.053.61 □ 25  
Art. 11.053.62 □ 30

Martellato / *Hammered*  
H.1200 mm.  
Art. 11.053.63 □ 25  
Art. 11.053.64 □ 30

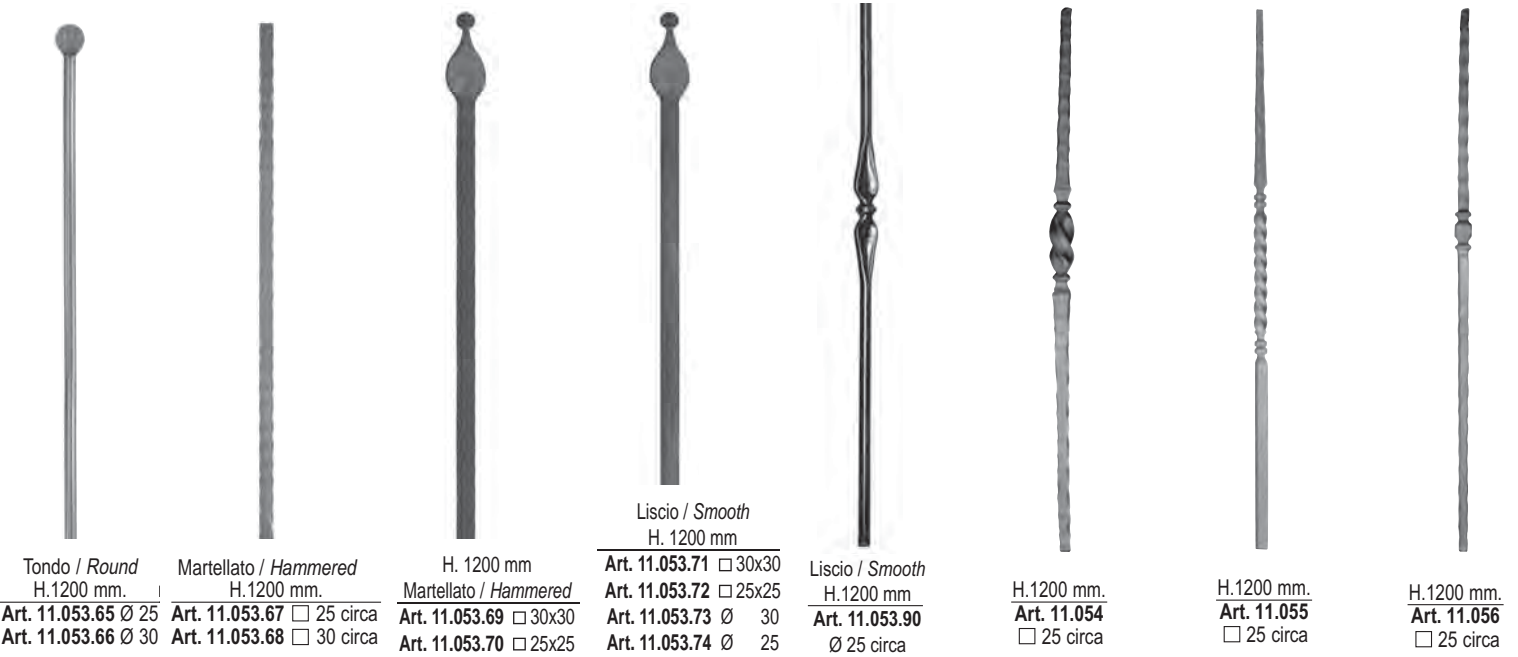

Tondo / *Round*  
H.1200 mm.  
Art. 11.053.65 Ø 25  
Art. 11.053.66 Ø 30

Martellato / *Hammered*  
H.1200 mm.  
Art. 11.053.67 □ 25 circa  
Art. 11.053.68 □ 30 circa

H. 1200 mm  
Martellato / *Hammered*  
Art. 11.053.69 □ 30x30  
Art. 11.053.70 □ 25x25

Liscio / *Smooth*  
H. 1200 mm  
Art. 11.053.71 □ 30x30  
Art. 11.053.72 □ 25x25  
Art. 11.053.73 Ø 30  
Art. 11.053.74 Ø 25

Liscio / *Smooth*  
H.1200 mm  
Art. 11.053.90  
Ø 25 circa

H.1200 mm.  
Art. 11.054  
□ 25 circa

H.1200 mm.  
Art. 11.055  
□ 25 circa

H.1200 mm.  
Art. 11.056  
□ 25 circa



H.1200 mm.  
Art. 11.057 □ 25 circa  
Art. 11.058 □ 30 circa

H.1200 mm.  
Art. 11.059 □ 25 circa  
Art. 11.060 □ 30 circa

H.1200 mm.  
Art. 11.059.P  
□ 25 circa

H.1200 mm.  
Art. 11.061 □ 25 circa  
Art. 11.062 □ 30 circa

H.1200 mm.  
Art. 11.063  
□ 25 circa

H.1200 mm.  
Art. 11.064  
□ 25 circa

H.1200 mm.  
Art. 11.065  
□ 25 circa

H.1200 mm.  
Art. 11.066  
□ 25 circa

Tutte le parti di questo catalogo - foto comprese - sono di proprietà Euro-Fer. La riproduzione, anche parziale, è vietata in ogni forma e con ogni mezzo. / Every part of this catalogue - photos included - is Euro-Fer's property. All forms of copying are strictly prohibited.

ELEMENTI IN FERRO FORGIATO E CAPISALDI  
FORGED BARS AND POSTS



H.1200 mm.  
Art. 11.067  
□ 25 circa



H.1200 mm  
Art. 11.067.01  
□ 25 circa



FIGURA IN TONDO  
ROUND MOTIF

H.1200 mm.  
Art. 11.068  
□ 25 mm



FIGURA IN QUADRO  
SQUARE MOTIF

H.1200 mm.  
Art. 11.068.01  
□ 25 mm



H.1200 mm.  
Art. 11.069  
□ 30 circa



H.1200 mm.  
Art. 11.070  
□ 25 mm



Smussato / Blunted  
H.1200 mm  
Art. 11.070.01  
□ 25 mm ca.



H.1200 mm.  
Art. 11.071  
□ 25 mm



Forgiato / Forged  
H.1200 mm  
Art. 11.071.01  
□ 25 circa



H.1200 mm.  
Art. 11.072  
□ 25 mm



H.1200 mm.  
Art. 11.073  
□ 25 mm



Martellato / Hammered  
H.1200 mm.  
Art. 11.074  
□ 25 mm



Liscio / Smooth  
H.1200 mm.  
Art. 11.075  
□ 25 mm



H.240 x L.200 mm  
Art. 11.077.01 □ 40 mm ca.



Tondo Lavorato / Round Hammered  
H.1100 X L.400 mm.  
Art. 11.077  
□ 30 mm



H.870 X L.480 mm.  
Art. 11.078

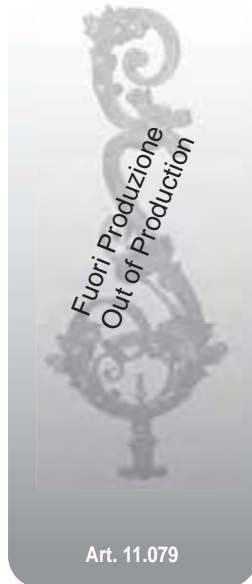

Fuori Produzione  
Out of Production

Art. 11.079



H.1100 x L.480 mm  
Art. 11.080

Tutte le parti di questo catalogo - foto comprese - sono di proprietà Euro-Fer. La riproduzione, anche parziale, è vietata in ogni forma e con ogni mezzo. / Every part of this catalogue - photos included - is Euro-Fer's property. All forms of copying are strictly prohibited.





H.160 mm.  
Art. 11.100  
□ 14 mm circa

H.160 mm.  
Art. 11.101  
□ 14 mm circa

H.160 mm.  
Art. 11.102  
Ø 12 mm circa

H.200 mm.  
Art. 11.150  
□ 24 mm circa

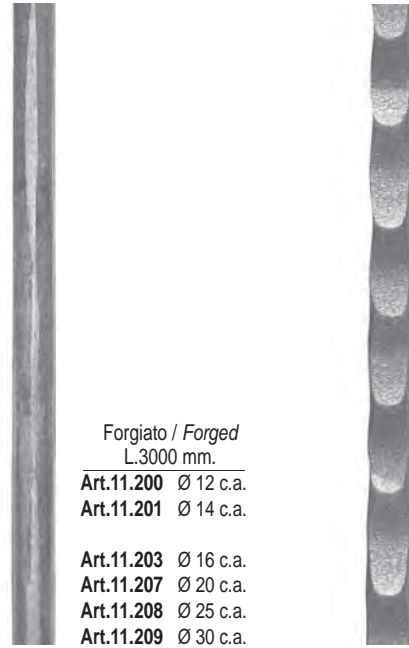

Forgiato / Forged  
L.3000 mm.

Art.11.200 Ø 12 c.a.

Art.11.201 Ø 14 c.a.

Art.11.203 Ø 16 c.a.

Art.11.207 Ø 20 c.a.

Art.11.208 Ø 25 c.a.

Art.11.209 Ø 30 c.a.

Forgiato / Forged  
L.3000 mm.

Art.11.210 □ 12 c.a.

Art.11.211 □ 14 c.a.



Rose Collection  
CRYSTALS FROM  
SWAROVSKI®

[www.rosecollection.it](http://www.rosecollection.it)



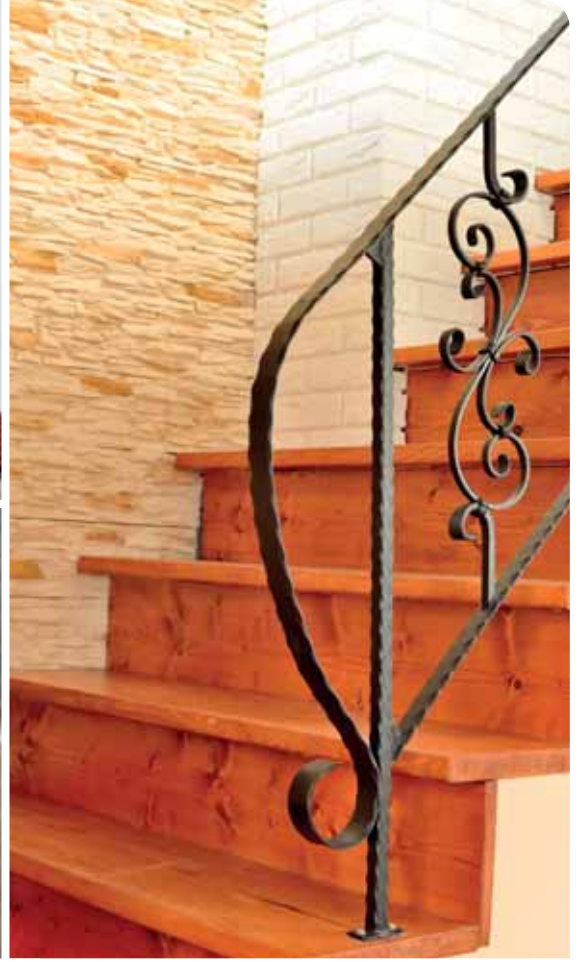



H.3000 mm.		H.6000 mm.	
Art. 12.001	≅ 25 X 6	Art. 12.007	≅ 25 X 6
Art. 12.002	≅ 25 X 8	Art. 12.008	≅ 25 X 8
Art. 12.003	≅ 30 X 6	Art. 12.009	≅ 30 X 6
Art. 12.004	≅ 30 X 8	Art. 12.010	≅ 30 X 8
Art. 12.004.01	≅ 35 X 8	Art. 12.010.01	≅ 35 X 8
Art. 12.005	≅ 40 X 8	Art. 12.011	≅ 40 X 8
Art. 12.006	≅ 50 X 10	Art. 12.012	≅ 50 X 10
Art. 12.006.01	≅ 20 X 5	Art. 12.012.01	≅ 20 X 5
Art. 12.006.02	≅ 20 X 6	Art. 12.012.02	≅ 20 X 6
Art. 12.006.03	≅ 20 X 8	Art. 12.012.03	≅ 20 X 8
Art. 12.006.04	≅ 25 X 10	Art. 12.012.04	≅ 25 X 10
Art. 12.006.05	≅ 25 X 12	Art. 12.012.05	≅ 25 X 12
Art. 12.006.06	≅ 30 X 4	Art. 12.012.06	≅ 30 X 4
Art. 12.006.07	≅ 30 X 10	Art. 12.012.07	≅ 30 X 10
Art. 12.006.08	≅ 30 X 12	Art. 12.012.08	≅ 30 X 12
Art. 12.006.09	≅ 35 X 10	Art. 12.012.09	≅ 35 X 10
Art. 12.006.10	≅ 40 X 6	Art. 12.012.10	≅ 40 X 6
Art. 12.006.11	≅ 40 X 10	Art. 12.012.11	≅ 40 X 10
Art. 12.006.12	≅ 50 X 8	Art. 12.012.12	≅ 50 X 8
Art. 12.006.13	≅ 100 X 10	Art. 12.012.13	≅ 100 X 10
Art. 12.006.14	≅ 100 X 8	Art. 12.012.14	≅ 100 X 8
Art. 12.006.15	≅ 100 X 6	Art. 12.012.15	≅ 100 X 6
Art. 12.006.16	≅ 70 X 6	Art. 12.012.16	≅ 70 X 6
Art. 12.006.17	≅ 50 X 6	Art. 12.012.17	≅ 50 X 6
Art. 12.006.18	≅ 60 X 6	Art. 12.012.18	≅ 60 X 6

Martellato su due spigoli  
Hammered on the upper edges



H.400 X L.100 mm.  
Art. 12.013 ≅ 40 X 8  
Art. 12.014 ≅ 50 X 10  
Art. 12.014.01 ≅ 50 X 8



H.400 X L.130 mm.  
Art. 12.015 ≅ 40 X 8  
Art. 12.016 ≅ 50 X 10  
Art. 12.016.01 ≅ 50 X 8



H.400 X L.100 mm.  
Art. 12.017 ≅ 40 X 8  
Art. 12.018 ≅ 50 X 10



H.400 X L.180 mm.  
Art. 12.018.01 ≅ 40 X 8



H.450 mm.  
Art. 12.019 ≅ 40 X 8



H.460 mm.  
Art. 12.020 ≅ 40 X 8



H.680 X L.140 mm.  
Art. 12.021 ≅ 40 X 8  
Art. 12.022 ≅ 50 X 10  
Art. 12.022.02 ≅ 50 X 8



H.840 X L.140 mm.  
Art. 12.022.01 ≅ 40 X 8  
Art. 12.022.03 ≅ 50 X 8



H.400 X L.400 mm.  
Art. 12.023 ≅ 25 X 8  
Art. 12.024 ≅ 30 X 8  
Art. 12.025 ≅ 40 X 8  
Art. 12.025.01 ≅ 35 X 8  
Art. 12.025.02 ≅ 50 X 8



H.200 X L.200 mm.  
Art. 12.026 ≅ 25 X 8 (mis. int. 130)  
Art. 12.027 ≅ 30 X 8 (mis. int. 125)  
Art. 12.028 ≅ 40 X 8 (mis. int. 120)



Martellato su due spigoli e rigato  
Hammered on the upper edges and fluted

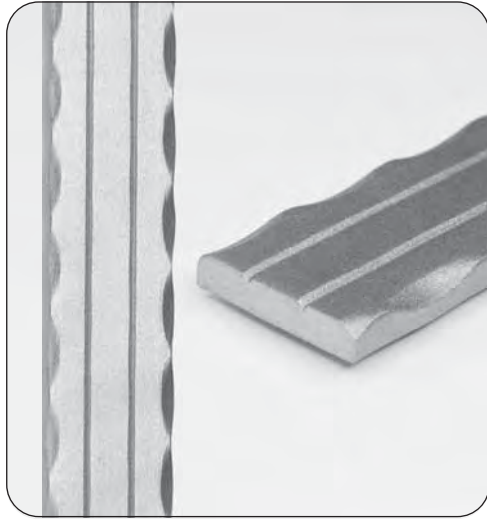

H.3000 mm.  
Art. 12.029 ≙ 40 X 8  
Art. 12.029.01 ≙ 50 X 10  
Art. 12.029.02 ≙ 40 X 6  
Art. 12.029.03 ≙ 30 X 8

H.6000 mm.  
Art. 12.030 ≙ 40 X 8  
Art. 12.030.01 ≙ 50 X 10  
Art. 12.030.02 ≙ 40 X 6  
Art. 12.030.03 ≙ 30 X 8

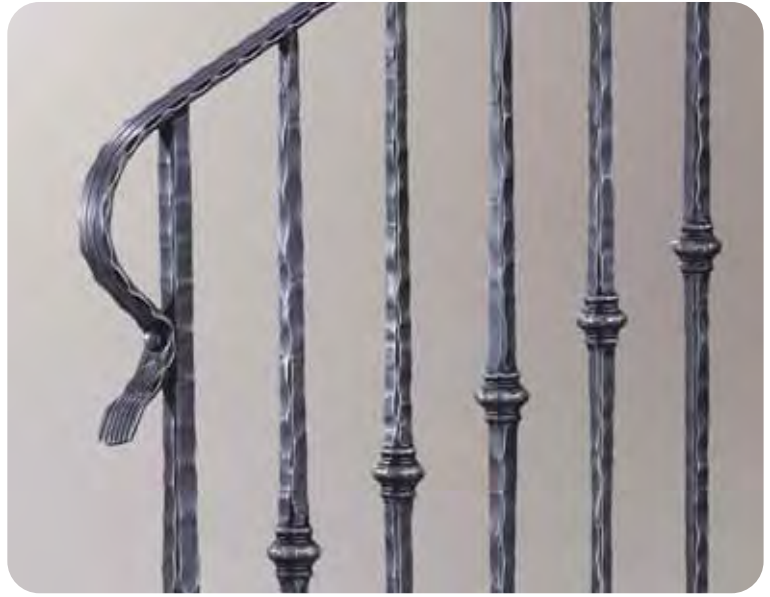

H.460 mm.  
Art. 12.031 ≙ 40 X 8

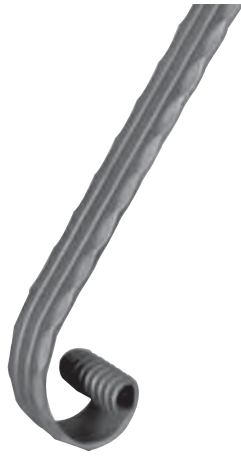

H.400 X L.100 mm.  
Art. 12.032 ≙ 40 X 8  
Art. 12.032.02 ≙ 50 X 10



H.400 X L.180 mm.  
Art. 12.032.01 ≙ 40 X 8  
Art. 12.032.03 ≙ 50 X 10



H.450 mm.  
Art. 12.033 ≙ 40 X 8



H.680 X L.140 mm.  
Art. 12.034 ≙ 40 X 8  
Art. 12.034.03 ≙ 50 X 10



H.840 X L.140 mm.  
Art. 12.034.01 ≙ 40 X 8  
Art. 12.034.04 ≙ 50 X 10



H.720 X L.250 mm.  
Art. 12.034.02 ≙ 40 X 8



H.200 X L.200 mm.  
Art. 12.036 ≙ 40 X 8 (mis. int. 120)



H.400 X L.400 mm.  
Art. 12.035 ≙ 40 X 8  
Art. 12.035.01 ≙ 50 X 10

Martellato su due spigoli e decorato  
*Hammered on the upper edges and decorated*

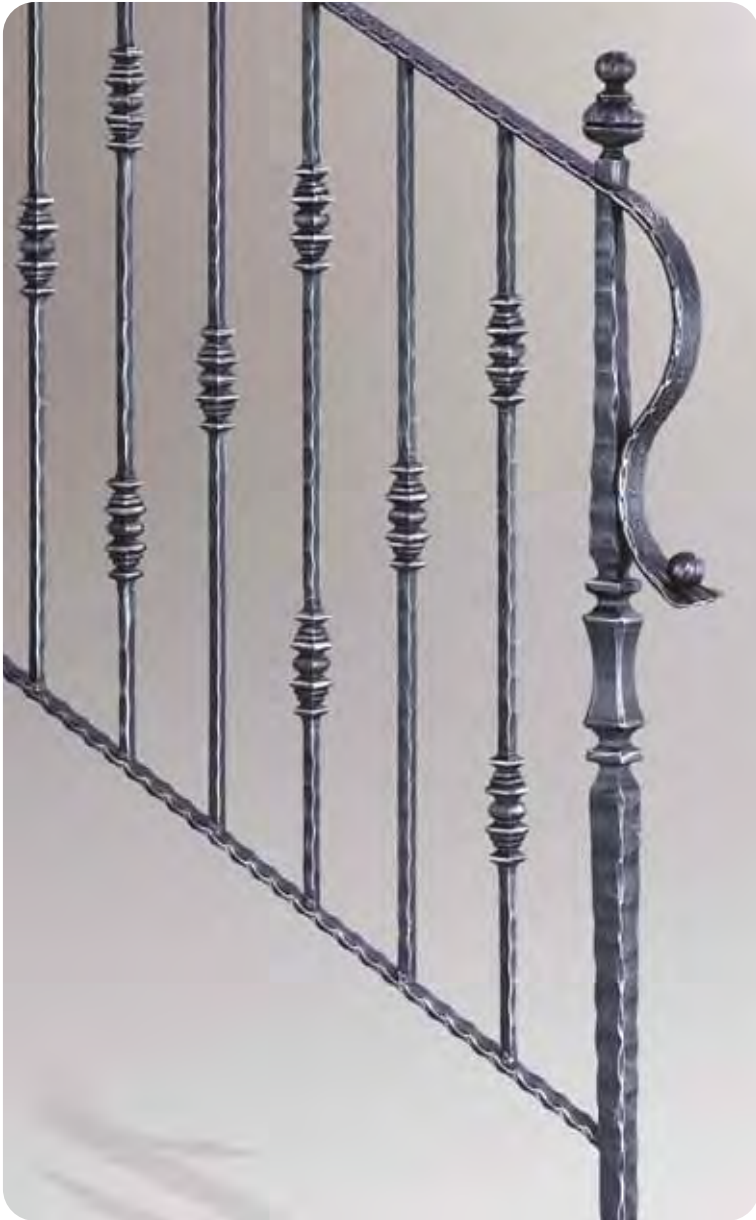

H.3000 mm.  
Art. 12.037 ≙ 40 X 4  
Art. 12.038 ≙ 40 X 8  
H.6000 mm.  
Art. 12.039 ≙ 40 X 4  
Art. 12.040 ≙ 40 X 8



H.400 X L.180 mm.  
Art. 12.040.01 ≙ 40 X 8



H.200 X L.200 mm.  
Art. 12.041 ≙ 40 X 8 (mis. int. 120)



H.830 X L.140 mm.  
Art. 12.042 ≙ 40 X 8



H.400 X L.100 mm.  
Art. 12.042.01 ≙ 40 X 8



H.460 mm.  
Art. 12.043 ≙ 40 X 8



H.680 mm.  
Art. 12.043.01 ≙ 40 X 8



H.400 X L.400 mm.  
Art. 12.044 ≙ 40 X 8

Tutte le parti di questo catalogo - foto comprese - sono di proprietà Euro-Fer. La riproduzione, anche parziale, è vietata in ogni forma e con ogni mezzo. / Every part of this catalogue - photos included - is Euro-Fer's property. All forms of copying are strictly prohibited.

Martellato su due spigoli e decorato  
*Hammered on the upper edges and decorated*

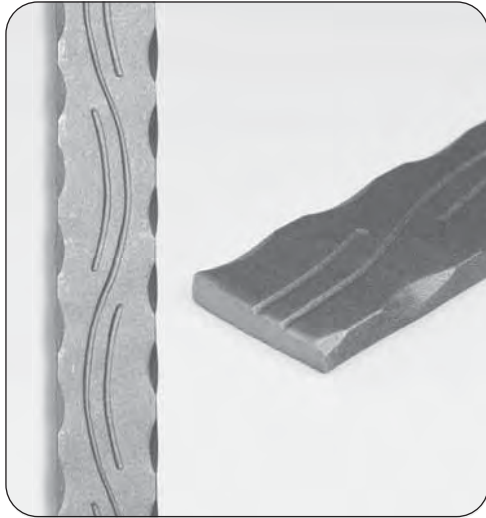

≠ 40 X 8  
Art. 12.045 H.3000 mm.  
Art. 12.046 H.6000 mm.



H.400 X L.180 mm.  
Art. 12.046.01 ≠ 40 X 8



H.400 X L.100 mm.  
Art. 12.047 ≠ 40 X 8



H.400 X L.400 mm.  
Art. 12.047.01 ≠ 40 X 8



H.460 mm.  
Art. 12.048 ≠ 40 X 8



H.650 mm.  
Art. 12.048.01 ≠ 40 X 8



H.200 X L.200 mm.  
Art. 12.049 ≠ 40 X 8 (mis. int. 120)

Martellato su due spigoli e decorato  
*Hammered on the upper edges and decorated*



≠ 40 X 8  
Art. 12.050 H.3000 mm.  
Art. 12.051 H.6000 mm.



H.400 X L.400 mm.  
Art. 12.051.01 ≠ 40 X 8



H.460 mm.  
Art. 12.052 ≠ 40 X 8



H.200 X L.200 mm.  
Art. 12.052.01 ≠ 40 X 8 (mis. int. 120)



Corrimano classico  
Classic handrail



H.6000 mm.  
Art. 12.053.02 ≙ 40 X 8  
Art. 12.054.02 ≙ 50 X 10

H.3000 mm.  
Art. 12.053 ≙ 40 X 8  
Art. 12.054 ≙ 50 X 10



H.450 mm.  
Art. 12.053.01 ≙ 40 X 8  
Art. 12.054.01 ≙ 50 X 10



H.400 X L.400 mm.  
Art. 12.055 ≙ 40 X 8  
Art. 12.055.01 ≙ 50 X 10



H.330 X L.100 mm.  
Art. 12.056 ≙ 40 X 8  
H.330 X L.135 mm.  
Art. 12.057 ≙ 50 X 10



H.400 X L.180 mm.  
Art. 12.056.01 ≙ 40 X 8  
Art. 12.057.01 ≙ 50 X 10



H.460 X L.140 mm.  
Art. 12.057.02 ≙ 50 X 10  
Art. 12.058 ≙ 40 X 8



H.200 X L.200 mm. (mis. int. 120)  
Art. 12.058.01 ≙ 40 X 8  
Art. 12.058.02 ≙ 50 X 10



**CORRIMANO E PARTENZE  
HANDRAILS AND CORNERS**

**Mezzotondo  
Half round**



H.3000 mm.

Art. 12.059	≠	30 X 8
Art. 12.059.02	≠	25 X 7
Art. 12.060	≠	30 X 10
Art. 12.061	≠	35 X 8
Art. 12.062	≠	35 X 10
Art. 12.063	≠	40 X 8
Art. 12.064	≠	40 X 10
Art. 12.065	≠	40 X 12
Art. 12.066	≠	50 X 10
Art. 12.067	≠	50 X 12

H.6000 mm.

Art. 12.059.01	≠	30 X 8
Art. 12.060.01	≠	30 X 10
Art. 12.061.01	≠	35 X 8
Art. 12.062.01	≠	35 X 10
Art. 12.063.01	≠	40 X 8
Art. 12.064.01	≠	40 X 10
Art. 12.065.01	≠	40 X 12
Art. 12.066.01	≠	50 X 10
Art. 12.067.01	≠	50 X 12



H.400 X L.400 mm.

Art. 12.067.02	≠	30 X 8
Art. 12.067.03	≠	30 X 10
Art. 12.067.04	≠	35 X 8
Art. 12.067.05	≠	35 X 10
Art. 12.067.06	≠	40 X 8
Art. 12.067.07	≠	40 X 10
Art. 12.067.08	≠	40 X 12
Art. 12.067.09	≠	50 X 10
Art. 12.067.10	≠	50 X 12



H.400 X L.35 mm.

Art. 12.067.11	≠	30 X 10
Art. 12.067.12	≠	35 X 10
Art. 12.067.13	≠	40 X 8
Art. 12.067.14	≠	40 X 10
Art. 12.067.15	≠	40 X 12
Art. 12.067.16	≠	50 X 10
Art. 12.067.17	≠	50 X 12

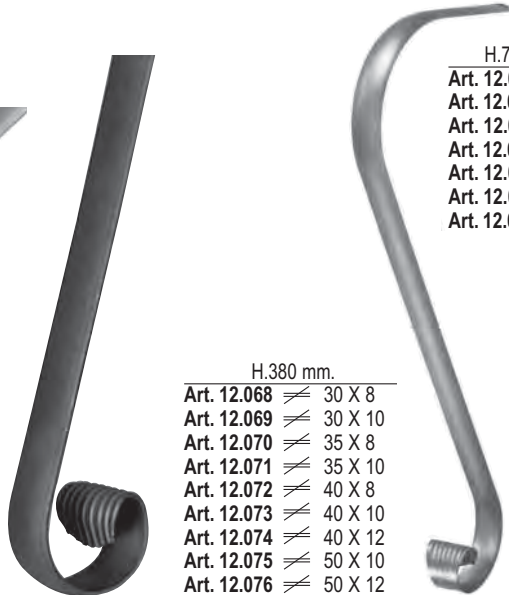

H.380 mm.

Art. 12.068	≠	30 X 8
Art. 12.069	≠	30 X 10
Art. 12.070	≠	35 X 8
Art. 12.071	≠	35 X 10
Art. 12.072	≠	40 X 8
Art. 12.073	≠	40 X 10
Art. 12.074	≠	40 X 12
Art. 12.075	≠	50 X 10
Art. 12.076	≠	50 X 12

H.720 X L.250 mm.

Art. 12.076.01	≠	30 X 10
Art. 12.076.02	≠	35 X 10
Art. 12.076.03	≠	40 X 8
Art. 12.076.04	≠	40 X 10
Art. 12.076.05	≠	40 X 12
Art. 12.076.06	≠	50 X 10
Art. 12.076.07	≠	50 X 12

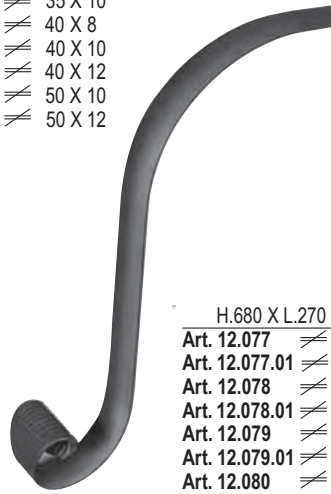

H.680 X L.270 mm.

Art. 12.077	≠	30 X 10
Art. 12.077.01	≠	35 X 10
Art. 12.078	≠	40 X 8
Art. 12.078.01	≠	40 X 10
Art. 12.079	≠	40 X 12
Art. 12.079.01	≠	50 X 12
Art. 12.080	≠	50 X 10



H.200 X L.200 mm. (mis. int. 120)

Art. 12.080.01	≠	30 X 8
Art. 12.080.02	≠	40 X 8
Art. 12.080.03	≠	50 X 10
Art. 12.080.04	≠	40 X 10

**Ferro stondato  
Rounded shape**

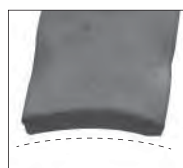

≠ 40 X 8

Art. 12.081	H.3000 mm.
Art. 12.082	H.6000 mm.



H.380 X L.180 mm.

Art. 12.082.01	≠	40 X 8
----------------	---	--------



H.400 X L.100 mm.

Art. 12.083	≠	40 X 8
-------------	---	--------



H.400 X L.400 mm.  
**Art. 12.083.01** ≙ 50 X 14  
**Art. 12.083.02** ≙ 40 X 12  
**Art. 12.083.03** ≙ 45 X 12  
**Art. 12.083.04** ≙ 60 X 16



H.3000 mm.  
**Art. 12.084** ≙ 50 X 14  
**Art. 12.084.01** ≙ 40 X 12  
**Art. 12.084.02** ≙ 45 X 12  
**Art. 12.084.03** ≙ 60 X 16

H.6000 mm.  
**Art. 12.085** ≙ 50 X 14  
**Art. 12.085.01** ≙ 40 X 12  
**Art. 12.085.02** ≙ 45 X 12  
**Art. 12.085.03** ≙ 60 X 16



Corrimano sagomato  
*Shaped hand rail*



H.400 mm.  
**Art. 12.086** ≙ 50 X 14  
**Art. 12.086.01** ≙ 40 X 12  
**Art. 12.086.02** ≙ 45 X 12  
**Art. 12.086.03** ≙ 60 X 16



H.300 X L.80 mm.  
**Art. 12.086.04** ≙ 50 X 14  
**Art. 12.086.05** ≙ 40 X 12  
**Art. 12.086.06** ≙ 45 X 12  
**Art. 12.086.07** ≙ 60 X 16



H.400 X L.35 mm.  
**Art. 12.086.08** ≙ 50 X 14  
**Art. 12.086.09** ≙ 40 X 12  
**Art. 12.086.10** ≙ 45 X 12  
**Art. 12.086.11** ≙ 60 X 16



H.100 X L.400 mm.  
**Art. 12.086.12** ≙ 50 X 14  
**Art. 12.086.13** ≙ 40 X 12  
**Art. 12.086.14** ≙ 45 X 12  
**Art. 12.086.15** ≙ 60 X 16



H.170 X L.400 mm.  
**Art. 12.087** ≙ 50 X 14  
**Art. 12.087.01** ≙ 40 X 12  
**Art. 12.087.02** ≙ 45 X 12  
**Art. 12.087.03** ≙ 60 X 16



H.680 mm.  
**Art. 12.087.04** ≙ 50 X 14  
**Art. 12.087.05** ≙ 40 X 12  
**Art. 12.087.06** ≙ 45 X 12  
**Art. 12.087.07** ≙ 60 X 16



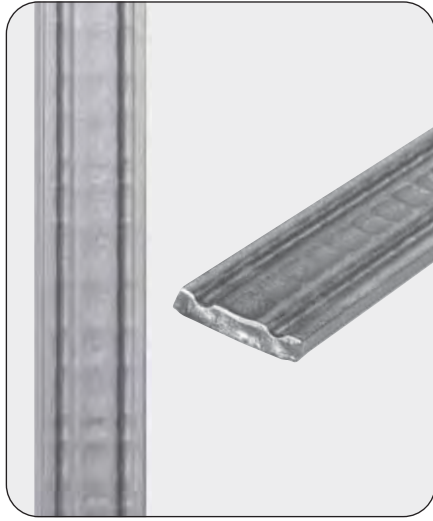

Corrimano rustico  
*Rustic handrail*

≠ 40 X 8  
Art. 12.087.08 H.3000 mm.  
Art. 12.087.09 H.6000 mm.

H.100 X L.400 mm.  
Art. 12.087.10 ≠ 40 X 8

H.180 X L.400 mm.  
Art. 12.087.11 ≠ 40 X 8

H.840 X L.140 mm.  
Art. 12.087.12 ≠ 40 X 8



H.680 mm.  
Art. 12.087.13 ≠ 40 X 8

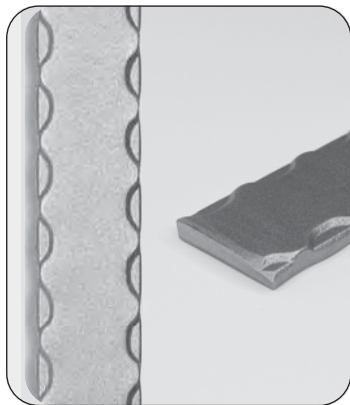

H.400 X L.400 mm.  
Art. 12.087.14 ≠ 40 X 8

Battuto su due spigoli superiori (mod. DUNE)  
*Hammered on the upper edges (mod. DUNE)*

≠ 40 X 8  
Art. 12.087.15 H.3000 mm.  
Art. 12.087.16 H.6000 mm.

H.100 X L.400 mm.  
Art. 12.087.17 ≠ 40 X 8

H.180 X L.400 mm.  
Art. 12.087.18 ≠ 40 X 8

H.680 mm.  
Art. 12.087.19 ≠ 40 X 8

H.840 mm.  
Art. 12.087.20 ≠ 40 X 8

H.400 X L.400 mm.  
Art. 12.087.21 ≠ 40 X 8

Martellato su due spigoli e decorato  
*Hammered on the upper edges and decorated*

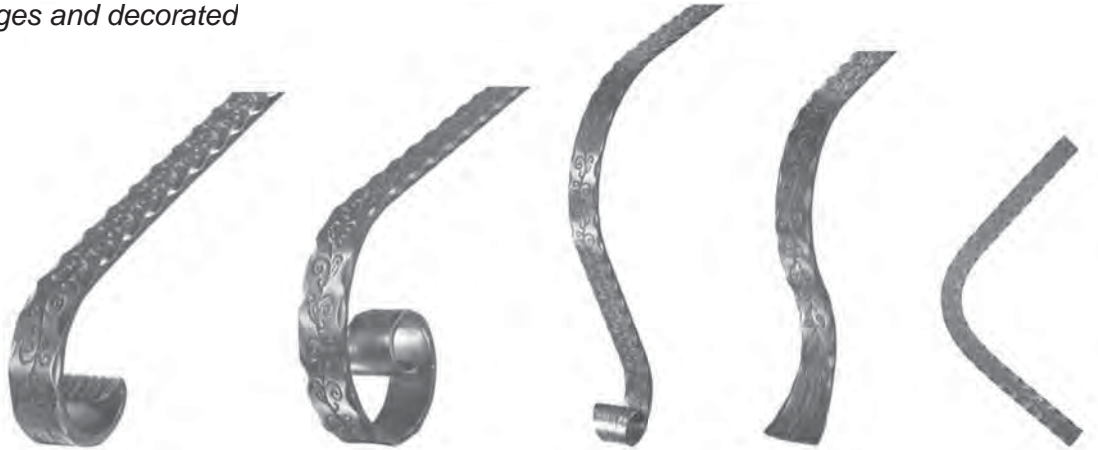

≅ 40 X 8  
Art. 12.087.22 H.3000 mm.  
Art. 12.087.23 H.6000 mm.

H.100 X L.400 mm.  
Art. 12.087.24 ≅ 40 X 8

H.180 X L.400 mm.  
Art. 12.087.25 ≅ 40 X 8

H.680 mm.  
Art. 12.087.26 ≅ 40 X 8

H.460 mm.  
Art. 12.087.27 ≅ 40 X 8

H.400 X L.400 mm.  
Art. 12.087.28 ≅ 40 X 8

Martellato su due spigoli e decorato  
*Hammered on the upper edges and decorated*

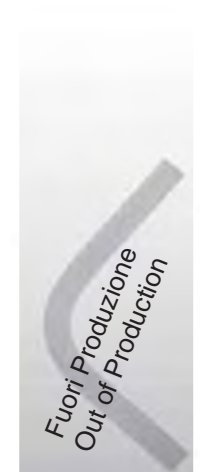
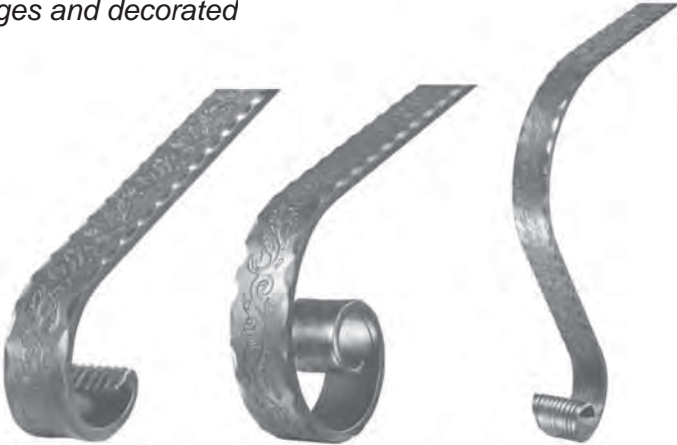
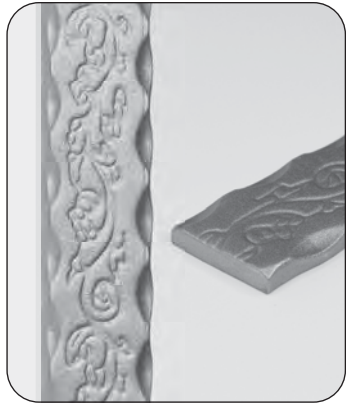

H.3000 mm  
Art. 12.087.29 ≅ 50 X 10  
Art. 12.087.36 ≅ 50 X 8  
Art. 12.087.43 ≅ 40 X 8

H.6000 mm  
Art. 12.087.30 ≅ 50 X 10  
Art. 12.087.37 ≅ 50 X 8  
Art. 12.087.44 ≅ 40 X 8

H.400 X L.100 mm.  
Art. 12.087.31 ≅ 50 X 10  
Art. 12.087.38 ≅ 50 X 8

H.400 X L.180 mm.  
Art. 12.087.32 ≅ 50 X 10  
Art. 12.087.39 ≅ 50 X 8

H.680 mm.  
Art. 12.087.33 ≅ 50 X 10  
Art. 12.087.40 ≅ 50 X 8

Art. 12.087.34  
Art. 12.087.41

Art. 12.087.35  
Art. 12.087.42

Non Prod. / Not Prod.

Non Prod. / Not Prod.



Tutte le parti di questo catalogo - foto comprese - sono di proprietà Euro-Fer. La riproduzione, anche parziale, è vietata in ogni forma e con ogni mezzo. / Every part of this catalogue - photos included - is Euro-Fer's property. All forms of copying are strictly prohibited.

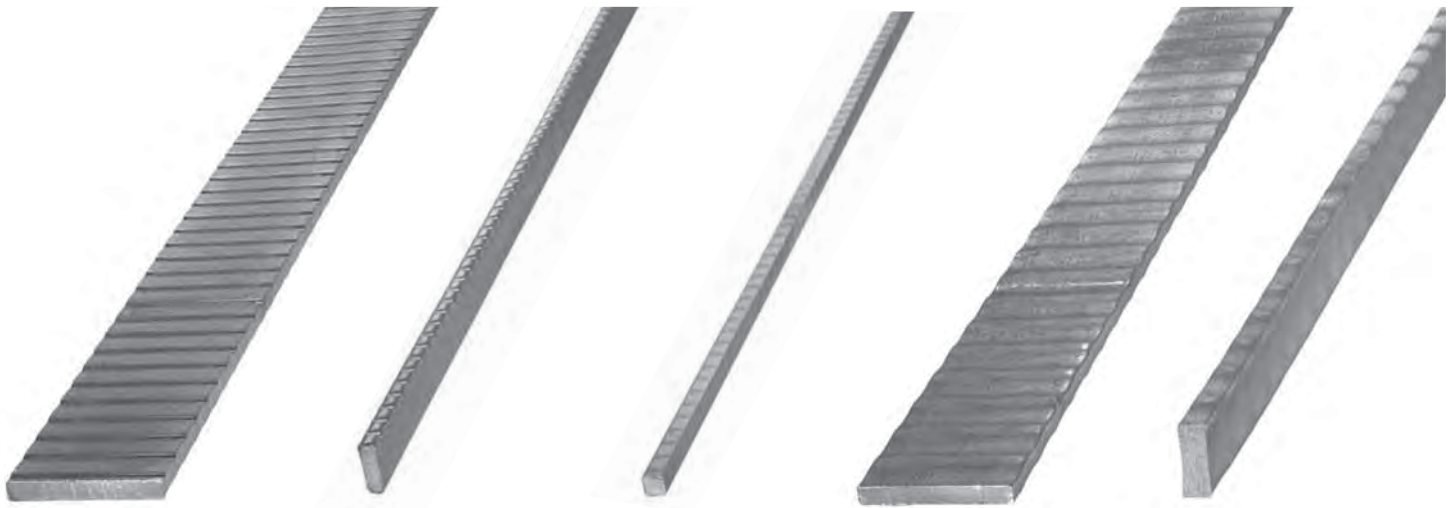

Piatto mod. scala battuto sopra e sotto / *Flat scala model beaten over and below (2 sides)*

H.3000 mm.	
Art. 12.088	≡ 30 X 8
Art. 12.089	≡ 40 X 8
Art. 12.090	≡ 40 X 10
Art. 12.091	≡ 50 X 10
Art. 12.091.01	≡ 60 X 8

H.6000 mm.	
Art. 12.092	≡ 30 X 8
Art. 12.093	≡ 40 X 8
Art. 12.094	≡ 40 X 10
Art. 12.095	≡ 50 X 10
Art. 12.095.01	≡ 60 X 8

Piatto mod. scala battuto sugli spessori / *Flat scala model beaten on the thicknesses (2 sides)*

H.3000 mm.	
Art. 12.095.02	≡ 10 X 5
Art. 12.095.03	≡ 12 X 6
Art. 12.095.04	≡ 14 X 6
Art. 12.095.05	≡ 16 X 6
Art. 12.095.06	≡ 20 X 6
Art. 12.095.30	≡ 16 X 8

H.6000 mm.	
Art. 12.095.07	≡ 14 X 6
Art. 12.095.08	≡ 16 X 6
Art. 12.095.09	≡ 20 X 6
Art. 12.095.31	≡ 16 X 8

Quadro mod. scala battuto sopra e sotto / *Square scala model beaten over and below (2 sides)*

H.3000 mm.	
Art. 12.095.10	□ 8

Piatto battuto sopra e sotto / *Flat bar beaten over and below (2 sides)*

H.3000 mm.	
Art. 12.095.11	≡ 60 X 8

H.6000 mm.	
Art. 12.095.12	≡ 60 X 8

Piatto battuto sugli spessori / *Flat bar beaten on the thicknesses (2 sides)*

H.3000 mm.	
Art. 12.095.13	≡ 25 X 10
Art. 12.095.14	≡ 30 X 10

H.6000 mm.	
Art. 12.095.15	≡ 25 X 10
Art. 12.095.16	≡ 30 X 10

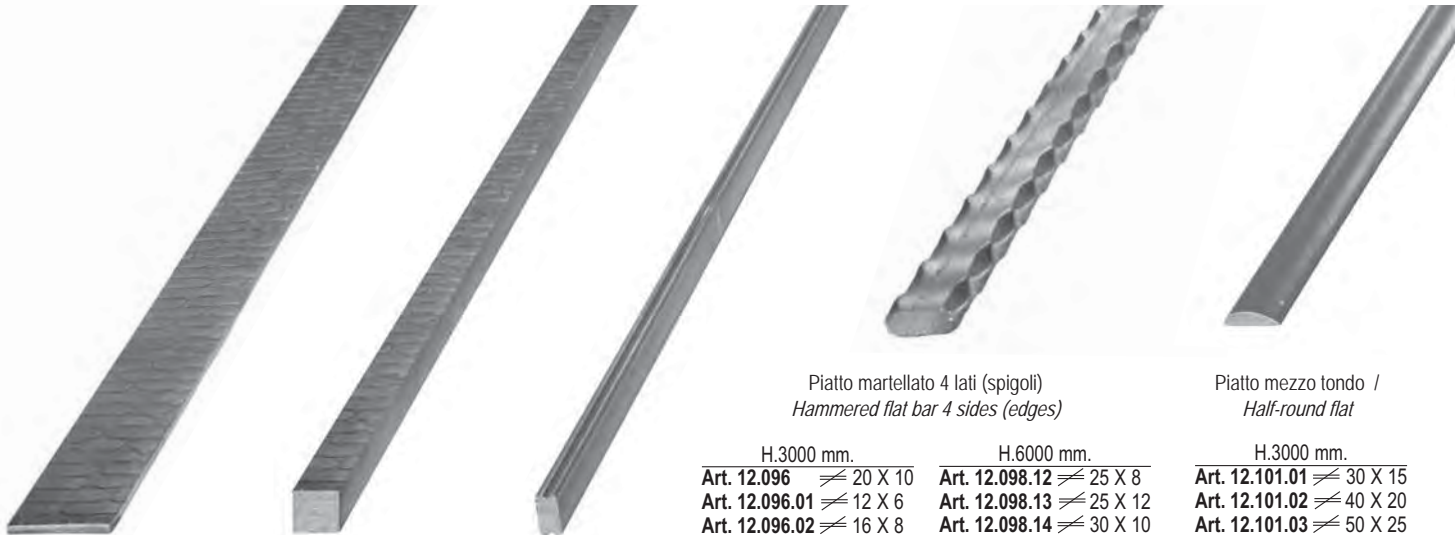

Piatto modello mattone battuto sopra e sotto / *Flat brick model beaten over and below (2 sides)*

H.3000 mm.	
Art. 12.095.17	≡ 20 X 4
Art. 12.095.18	≡ 25 X 4
Art. 12.095.19	≡ 25 X 6
Art. 12.095.20	≡ 25 X 8
Art. 12.095.21	≡ 30 X 4
Art. 12.095.22	≡ 30 X 6
Art. 12.095.23	≡ 30 X 8
Art. 12.095.24	≡ 40 X 4
Art. 12.095.25	≡ 40 X 6
Art. 12.095.26	≡ 40 X 8

Quadro modello mattone su 2 lati / *Square brick model beaten on 2 sides*

H.3000 mm.	
Art. 12.095.27	□ 12
Art. 12.095.32	□ 14

Piatto rigato sugli spessori / *Flat bar fluted on the thicknesses (2 sides)*

H.3000 mm.	
Art. 12.095.28	≡ 12 X 6
Art. 12.095.29	≡ 16 X 8

Piatto martellato 4 lati (spigoli) / *Hammered flat bar 4 sides (edges)*

H.3000 mm.		H.6000 mm.	
Art. 12.096	≡ 20 X 10	Art. 12.098.12	≡ 25 X 8
Art. 12.096.01	≡ 12 X 6	Art. 12.098.13	≡ 25 X 12
Art. 12.096.02	≡ 16 X 8	Art. 12.098.14	≡ 30 X 10
Art. 12.097	≡ 25 X 10	Art. 12.098.15	≡ 30 X 20
Art. 12.098	≡ 30 X 8	Art. 12.098.16	≡ 35 X 8
Art. 12.098.01	≡ 16 X 5	Art. 12.098.17	≡ 35 X 10
Art. 12.098.02	≡ 20 X 6	Art. 12.098.18	≡ 40 X 8
Art. 12.098.03	≡ 25 X 6	Art. 12.098.19	≡ 40 X 10
Art. 12.098.04	≡ 25 X 8	Art. 12.098.23	≡ 35 X 15
Art. 12.098.05	≡ 25 X 12	Art. 12.098.24	≡ 30 X 6
Art. 12.098.06	≡ 30 X 10	Art. 12.098.25	≡ 50 X 8
Art. 12.098.07	≡ 30 X 20	Art. 12.099	≡ 20 X 10
Art. 12.098.08	≡ 35 X 8	Art. 12.100	≡ 25 X 10
Art. 12.098.09	≡ 35 X 10	Art. 12.101	≡ 30 X 8
Art. 12.098.10	≡ 40 X 8	Art. 12.098.27	≡ 30 X 15
Art. 12.098.11	≡ 40 X 10		
Art. 12.098.20	≡ 35 X 15		
Art. 12.098.21	≡ 30 X 6		
Art. 12.098.22	≡ 50 X 8		
Art. 12.098.26	≡ 30 X 15		

Piatto mezzo tondo / *Half-round flat*

H.3000 mm.	
Art. 12.101.01	≡ 30 X 15
Art. 12.101.02	≡ 40 X 20
Art. 12.101.03	≡ 50 X 25
Art. 12.101.04	≡ 60 X 30
Art. 12.101.09	≡ 16 X 8
Art. 12.101.10	≡ 20 X 10
Art. 12.101.11	≡ 35 X 15
Art. 12.101.12	≡ 40 X 15

H.6000 mm.	
Art. 12.101.05	≡ 30 X 15
Art. 12.101.06	≡ 40 X 20
Art. 12.101.07	≡ 50 X 25
Art. 12.101.08	≡ 60 X 30
Art. 12.101.13	≡ 16 X 8
Art. 12.101.14	≡ 20 X 10
Art. 12.101.15	≡ 35 X 15
Art. 12.101.16	≡ 40 X 15
Art. 12.101.20	≡ 60 X 20



BARRE PER FASCETTE / COLLAR BARS



H.4000 mm.  
Art. 12.108  $\neq$  14 X 4

H.3000 mm.  
Art. 12.108.01  $\neq$  25 X 8  
Art. 12.108.02  $\neq$  30 X 8  
Art. 12.108.05  $\neq$  40 X 8

H.6000 mm.  
Art. 12.108.03  $\neq$  25 X 8  
Art. 12.108.04  $\neq$  30 X 8  
Art. 12.108.06  $\neq$  40 X 8  
Art. 12.108.08  $\neq$  40 X 13



H.4000 mm.  
Art. 12.109  $\neq$  18 X 6



H.4000 mm.  
Art. 12.110  $\neq$  18 X 5



H.4000 mm.  
Art. 12.111  $\neq$  14 X 4



H.3000 mm.  
Art. 12.112  $\neq$  10 X 3  
Art. 12.113  $\neq$  12 X 3  
Art. 12.114  $\neq$  14 X 3  
Art. 12.115  $\neq$  16 X 4  
Art. 12.116  $\neq$  20 X 4

Non Prod. / Not Prod.



H.4000 mm.  
Art. 12.117  $\neq$  11 X 3  
Art. 12.118  $\neq$  14 X 4  
Art. 12.119  $\neq$  16 X 5  
Art. 12.120  $\neq$  21 X 6

NEW

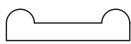

H. 3000 mm.  
Art. 12.108.10  $\neq$  25 X 8  
Art. 12.108.11  $\neq$  30 X 8

Barra Tacchettato/Scala / Collar bar Scala Model



H.3000 mm.  
Art. 12.120.02  $\neq$  15 X 3



H.3000 mm.  
Art. 12.120.03  $\neq$  20 X 4



$\neq$  14 X 4 mm.  
Art. 12.122 2  $\neq$  12 X 6  
Art. 12.123 2  $\neq$  12 X 6  
+ 1  $\square$  12 X 12  
Art. 12.124 2  $\square$  8 X 8



$\neq$  18 X 6 mm.  
Art. 12.125 1  $\square$  20 X 20



$\neq$  14 X 4 mm.  
Art. 12.126 2  $\neq$  12 X 6  
Art. 12.127 2  $\neq$  12 X 6  
+ 1  $\square$  12 X 12  
Art. 12.128 2  $\square$  8 X 8  
Art. 12.129 3  $\square$  8 X 8

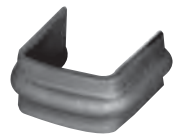

$\neq$  18 X 5 mm.  
Art. 12.130 2  $\neq$  12 X 6  
+1  $\square$  12 X 12

Art. 12.130.01 1  $\neq$  12 X 6  
+1  $\square$  12 X 12

Art. 12.130.02 1  $\neq$  14 X 6  
+1  $\square$  14 X 14

Art. 12.130.03 2  $\neq$  14 X 6  
+1  $\square$  14 X 14

Art. 12.130.04 1  $\neq$  16 X 6  
+1  $\square$  16 X 16

Art. 12.130.05 2  $\neq$  16 X 6  
+1  $\square$  16 X 16



$\neq$  14 X 4 mm.  
Art. 12.131 2  $\neq$  20 X 6  
Art. 12.132 3  $\neq$  20 X 4  
Art. 12.133 3  $\neq$  20 X 6  
Art. 12.134 2  $\neq$  12 X 6  
+1  $\square$  12 X 12

Art. 12.134.01 1  $\neq$  12 X 6  
+1  $\square$  12 X 12

Art. 12.134.02 1  $\neq$  14 X 6  
+1  $\square$  14 X 14

Art. 12.134.03 2  $\neq$  14 X 6  
+1  $\square$  14 X 14

Art. 12.134.04 1  $\neq$  16 X 6  
+1  $\square$  16 X 16

Art. 12.134.05 2  $\neq$  16 X 6  
+1  $\square$  16 X 16



Quadro martellato sui 4 spigoli / Hammered square on the 4 edges

H.3000 mm.	H.3000 mm.
Art. 12.135 ≡ 16 X 4	Art. 12.143 □ 6 X 6
Art. 12.136 ≡ 20 X 4	Art. 12.144 □ 8 X 8
Art. 12.137 ≡ 30 X 4	Art. 12.145 □ 10 X 10
Art. 12.138 ≡ 25 X 5	Art. 12.146 □ 12 X 12
	Art. 12.147 □ 14 X 14
	Art. 12.148 □ 16 X 16
	Art. 12.149 □ 18 X 18
	Art. 12.150 □ 20 X 20
	Art. 12.151 □ 25 X 25
	Art. 12.152 □ 30 X 30
	Art. 12.153 □ 35 X 35
	Art. 12.154 □ 40 X 40
	H.6000 mm.
Art. 12.139 ≡ 16 X 4	Art. 12.155 □ 6 X 6
Art. 12.140 ≡ 20 X 4	Art. 12.156 □ 8 X 8
Art. 12.141 ≡ 30 X 4	Art. 12.157 □ 10 X 10
Art. 12.142 ≡ 25 X 5	Art. 12.158 □ 12 X 12
	Art. 12.159 □ 14 X 14
	Art. 12.160 □ 16 X 16
	Art. 12.161 □ 18 X 18
	Art. 12.162 □ 20 X 20
	Art. 12.163 □ 25 X 25
	Art. 12.164 □ 30 X 30
	Art. 12.165 □ 35 X 35
	Art. 12.166 □ 40 X 40

c.

Mod. Liquirizia  
*Liquorice Model*

H.3000 mm.

Art. 12.166.01 □ 12 X 12
Art. 12.166.02 □ 14 X 14
Art. 12.166.03 □ 16 X 16

## Funi con Tondino

H.5700 mm.

Art. 12.167 Ø 16 4 tondini / 4 rods Ø 6mm.
Art. 12.168 Ø 20 4 tondini / 4 rods Ø 8mm.
Art. 12.169 Ø 25 4 tondini / 4 rods Ø 10mm.
Art. 12.170 Ø 30 4 tondini / 4 rods Ø 12mm.

## Funi con Quadro

H.5700 mm.

Art. 12.171 □ 23 X 23
Art. 12.172 □ 28 X 28
Art. 12.173 □ 34 X 34
Art. 12.174 □ 39 X 39

Quadro Martellato  
*Hammered Square*

H.3000 mm.

Art. 12.175 □ 12 X 12
Art. 12.176 □ 14 X 14
Art. 12.177 □ 16 X 16
Art. 12.178 □ 20 X 20
Art. 12.179 □ 25 X 25
Art. 12.180 □ 30 X 30
Art. 12.181 □ 40 X 40
Art. 12.181.01 □ 18 X 18
Art. 12.181.02 □ 35 X 35

H.6000 mm.

Art. 12.182 □ 12 X 12
Art. 12.183 □ 14 X 14
Art. 12.184 □ 16 X 16
Art. 12.185 □ 20 X 20
Art. 12.186 □ 25 X 25
Art. 12.187 □ 30 X 30
Art. 12.188 □ 40 X 40
Art. 12.188.01 □ 18 X 18
Art. 12.188.02 □ 35 X 35

Tondo Martellato  
*Hammered Round*

H.3000 mm.

Art. 12.175.01 Ø 12
Art. 12.176.01 Ø 14
Art. 12.176.02 Ø 16
Art. 12.176.03 Ø 18
Art. 12.176.04 Ø 20
Art. 12.176.05 Ø 25
Art. 12.176.06 Ø 30
H.6000 mm.
Art. 12.182.01 Ø 12
Art. 12.183.01 Ø 14
Art. 12.183.02 Ø 16
Art. 12.183.03 Ø 18
Art. 12.183.04 Ø 20
Art. 12.183.05 Ø 25
Art. 12.183.06 Ø 30





Rigato e martellato  
su 4 facce  
*Hammered and Fluted  
on 4 sides*

H.3000 mm.  
Art. 12.189  12 X 12  
Art. 12.190  14 X 14

H.6000 mm.  
Art. 12.191  12 X 12  
Art. 12.192  14 X 14



Barre in Spigolo  
*Edged Bar*

H.3000 mm.  
Art. 12.192.01  12 X 12  
Art. 12.192.02  14 X 14  
Art. 12.192.03  16 X 16  
Art. 12.192.04  18 X 18  
Art. 12.192.05  20 X 20

H.6000 mm.  
Art. 12.192.06  12 X 12  
Art. 12.192.07  14 X 14  
Art. 12.192.08  16 X 16  
Art. 12.192.09  18 X 18  
Art. 12.192.10  20 X 20  
Art. 12.192.11  25 X 25  
Art. 12.192.12  30 X 30



Rigato 4 facce  
*Fluted 4 faces*

H.3000 mm.  
Art. 12.193  12 X 12  
Art. 12.194  14 X 14  
Art. 12.194.01  16 X 16

H.6000 mm.  
Art. 12.195  12 X 12  
Art. 12.196  14 X 14  
Art. 12.194.02  16 X 16

Rigato 2 facce  
*Fluted 2 faces*

H.3000 mm.  
Art. 12.194.03  12  
Art. 12.194.04  14  
Art. 12.194.05  16

H.6000 mm.  
Art. 12.194.06  12  
Art. 12.194.07  14  
Art. 12.194.08  16



Modello Corteccia  
*Bark Model*

H.3000 mm.  
Art. 12.196.01  Ø 14  
Art. 12.196.02  Ø 16  
Art. 12.196.03  Ø 20  
Art. 12.196.04  Ø 22  
Art. 12.196.09  Ø 18  
Art. 12.196.10  Ø 25  
Art. 12.196.11  Ø 30  
Art. 12.196.15  Ø 12

H.6000 mm.  
Art. 12.196.05  Ø 14  
Art. 12.196.06  Ø 16  
Art. 12.196.07  Ø 20  
Art. 12.196.08  Ø 22  
Art. 12.196.12  Ø 18  
Art. 12.196.13  Ø 25  
Art. 12.196.14  Ø 30  
Art. 12.196.16  Ø 12



Modello Corteccia  
*Bark Model*

H.3000 mm.  
Art. 12.196.50  12  
Art. 12.196.51  14  
Art. 12.196.52  16

H.6000 mm.  
Art. 12.196.61  12  
Art. 12.196.62  14  
Art. 12.196.63  16



Modello Scala  
*Scala Model*

H.3000 mm.  
Art. 12.197  12 X 12  
Art. 12.198  14 X 14  
Art. 12.199  16 X 16  
Art. 12.200  18 X 18  
Art. 12.201  20 X 20  
Art. 12.202  25 X 25  
Art. 12.203  30 X 30  
Art. 12.204  40 X 40

H.6000 mm.  
Art. 12.205  12 X 12  
Art. 12.206  14 X 14  
Art. 12.207  16 X 16  
Art. 12.208  18 X 18  
Art. 12.209  20 X 20  
Art. 12.210  25 X 25  
Art. 12.211  30 X 30  
Art. 12.212  40 X 40



Piatto Modello Scala  
*Flat Scala Model*

H.3000 mm.  
Art. 12.204.01  30 X 20

H.6000 mm.  
Art. 12.212.01  30 X 20



Quadro battuto 4 lati  
*Square Bars Hammered on 4 sides*

H.3000 mm.  
Art. 12.213  12 X 12  
Art. 12.214  14 X 14  
Art. 12.215  16 X 16  
Art. 12.216  18 X 18  
Art. 12.217  20 X 20  
Art. 12.218  25 X 25  
Art. 12.219  30 X 30  
Art. 12.220  35 X 35  
Art. 12.221  40 X 40

H.6000 mm.  
Art. 12.222  12 X 12  
Art. 12.223  14 X 14  
Art. 12.224  16 X 16  
Art. 12.225  18 X 18  
Art. 12.226  20 X 20  
Art. 12.227  25 X 25  
Art. 12.228  30 X 30  
Art. 12.229  35 X 35  
Art. 12.230  40 X 40



Piatto battuto 2 lati  
*Flat Bars Hammered on 2 sides*

H.3000 mm.  
Art. 12.221.01  30 X 20

H.6000 mm.  
Art. 12.228.01  30 X 20

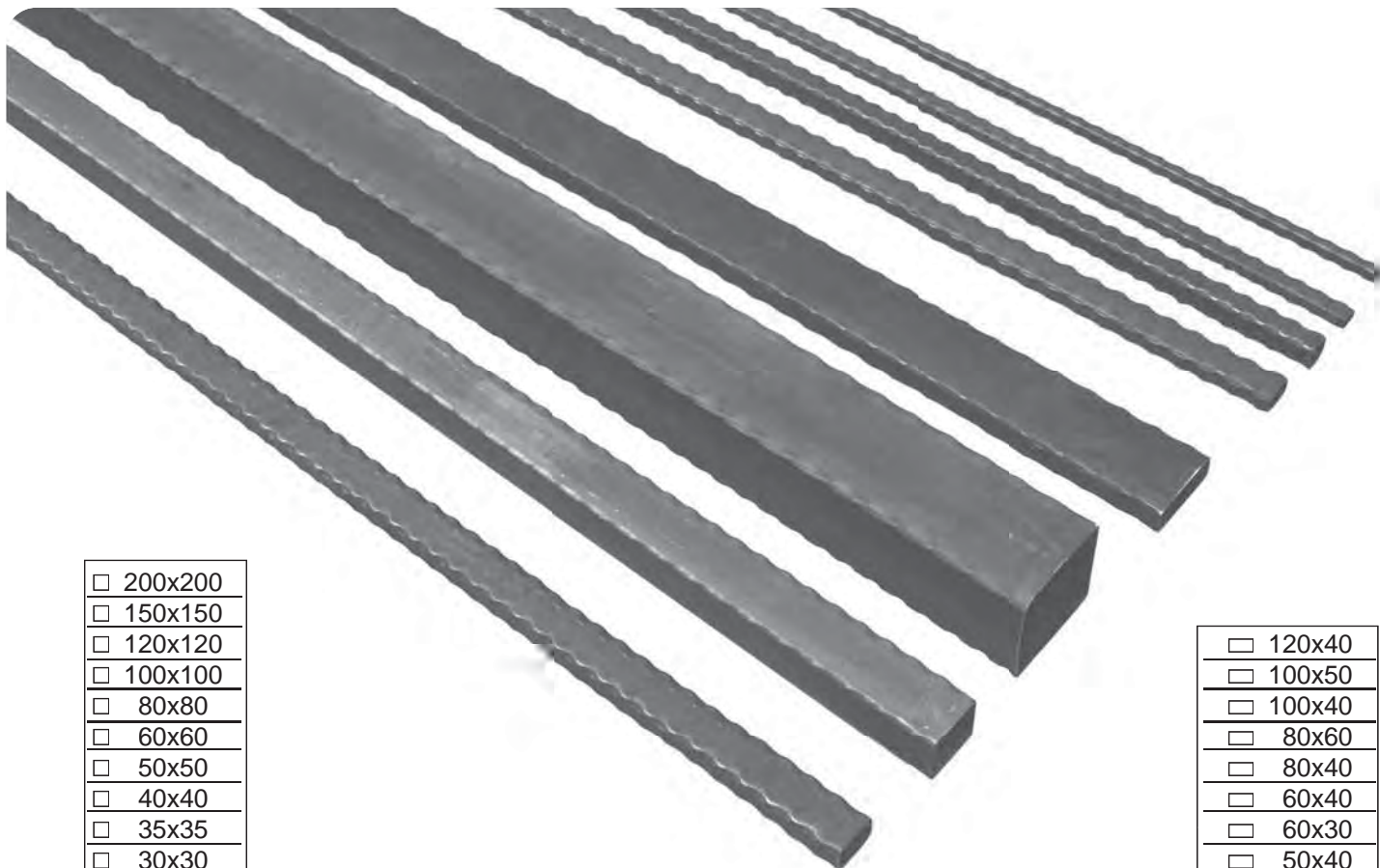

Tubo martellato / *Hammered Tube*

□ 200x200
□ 150x150
□ 120x120
□ 100x100
□ 80x80
□ 60x60
□ 50x50
□ 40x40
□ 35x35
□ 30x30
□ 25x25
□ 20x20
□ 15x15
□ 12x12

□ 120x40
□ 100x50
□ 100x40
□ 80x60
□ 80x40
□ 60x40
□ 60x30
□ 50x40
□ 50x30
□ 40x30
□ 40x20
□ 30x20

□ 200 X 200 X 4 mm.  
Art. 12.230.07 H.3000 mm.  
Art. 12.230.08 H.6000 mm.

□ 50 X 50 X 2,5 mm.  
Art. 12.235 H.3000 mm.  
Art. 12.236 H.6000 mm.

□ 120 X 40 X 3 mm.  
Art. 12.244.08 H.3000 mm.  
Art. 12.244.11 H.6000 mm.

□ 60 X 30 X 2,5 mm.  
Art. 12.246.01 H.3000 mm.  
Art. 12.246.02 H.6000 mm.

□ 150 X 150 X 4 mm.  
Art. 12.230.05 H.3000 mm.  
Art. 12.230.06 H.6000 mm.

□ 40 X 40 X 2,5 mm.  
Art. 12.237 H.3000 mm.  
Art. 12.238 H.6000 mm.

□ 100 X 50 X 3 mm.  
Art. 12.244.07 H.3000 mm.  
Art. 12.244.10 H.6000 mm.

□ 50 X 40 X 2,5 mm.  
Art. 12.247 H.3000 mm.  
Art. 12.248 H.6000 mm.

□ 120 X 120 X 3 mm.  
Art. 12.230.01 H.3000 mm.  
Art. 12.230.02 H.6000 mm.

□ 35 X 35 X 3 mm.  
Art. 12.238.01 H.3000 mm.  
Art. 12.238.02 H.6000 mm.

□ 100 X 40 X 3 mm.  
Art. 12.244.03 H.3000 mm.  
Art. 12.244.04 H.6000 mm.

□ 50 X 30 X 2,5 mm.  
Art. 12.249 H.3000 mm.  
Art. 12.250 H.6000 mm.

□ 100 X 100 X 3 mm.  
Art. 12.230.03 H.3000 mm.  
Art. 12.230.04 H.6000 mm.

□ 30 X 30 X 2,5 mm.  
Art. 12.239 H.3000 mm.  
Art. 12.240 H.6000 mm.

□ 80 X 60 X 3 mm.  
Art. 12.244.09 H.3000 mm.  
Art. 12.244.12 H.6000 mm.

□ 40 X 30 X 2,5 mm.  
Art. 12.250.01 H.3000 mm.  
Art. 12.250.02 H.6000 mm.

□ 80 X 80 X 2,5 mm.  
Art. 12.231 H.3000 mm.  
Art. 12.232 H.6000 mm.

□ 25 X 25 X 2,5 mm.  
Art. 12.241 H.3000 mm.  
Art. 12.242 H.6000 mm.

□ 80 X 40 X 2,5 mm.  
Art. 12.244.05 H.3000 mm.  
Art. 12.244.06 H.6000 mm.

□ 40 X 20 X 2 mm.  
Art. 12.251 H.3000 mm.  
Art. 12.252 H.6000 mm.

□ 60 X 60 X 2,5 mm.  
Art. 12.233 H.3000 mm.  
Art. 12.234 H.6000 mm.

H.3000 mm.  
Art. 12.243 □ 20 X 20 X 2  
Art. 12.244.01 □ 12 X 12 X 1,5  
Art. 12.244.02 □ 15 X 15 X 1,5  
H.6000 mm.  
Art. 12.244 □ 20 X 20 X 2

□ 60 X 40 X 2,5 mm.  
Art. 12.245 H.3000 mm.  
Art. 12.246 H.6000 mm.

□ 30 X 20 X 2 mm.  
Art. 12.253 H.3000 mm.  
Art. 12.254 H.6000 mm.

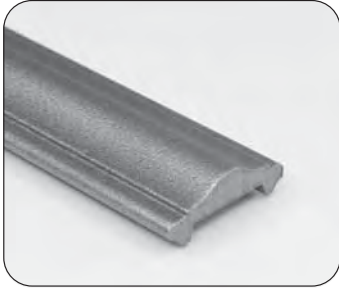

H.3000 mm.  
Art. 12.261 □ 16 mm



H.3000 mm.  
Art. 12.262 □ 15 mm

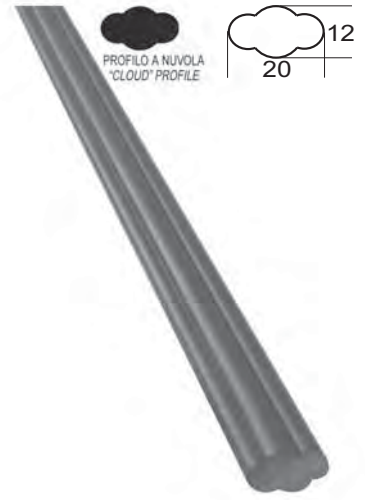

H.4000 mm.  
Art. 12.263 ≡ 20 X 12 mm

PROFILO A NUVOLA  
'CLOUD' PROFILE



H.3000 mm  
Art. 12.270 ≡ A = 55 / B = 17 / C = 25 mm  
Art. 12.270.01 ≡ A = 45 / B = 15 / C = 22 mm

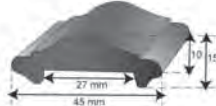

H.3000 mm  
Art. 12.271 ≡ 45 X 15

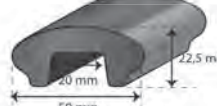

H.6000 mm  
Art. 12.272  
≡ A = 50 / B = 22,5 / C = 20 mm

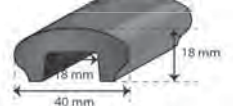

H.6000 mm  
Art. 12.272.01  
≡ A = 40 / B = 18 / C = 18 mm

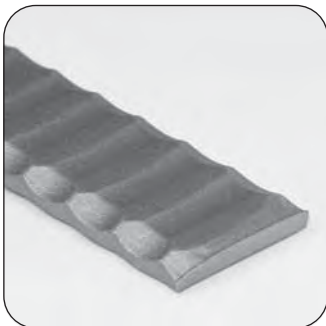

Martellato / Hammered  
H.3000 mm.  
Art. 12.273 ≡ 40 X 8 mm  
H.6000 mm.  
Art. 12.273.01 ≡ 40 X 8 mm



Lavorato / Worked  
H.3000 mm.  
Art.12.274 ≡ 40 x 8 mm



PARTENZone



Stop agli allineamenti e alla saldatura tra partenza e corrimano.

Ecco la prima rampa della tua scala in un unico pezzo già pronta per l'installazione e facilmente adattabile alle tue esigenze con un semplice taglio.



PARTENZone



Stop alignments and welding between start and handrails.

Here is the first flight of your staircase in one piece ready for installation that can easily be adapted to your needs with a simple cut.

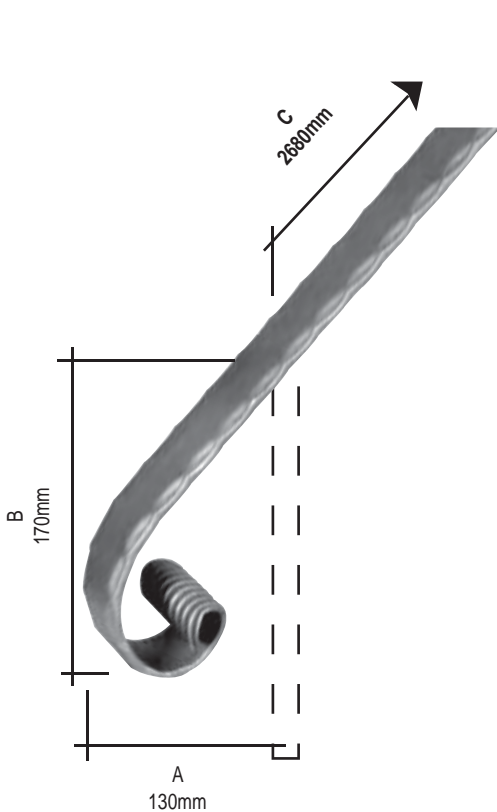
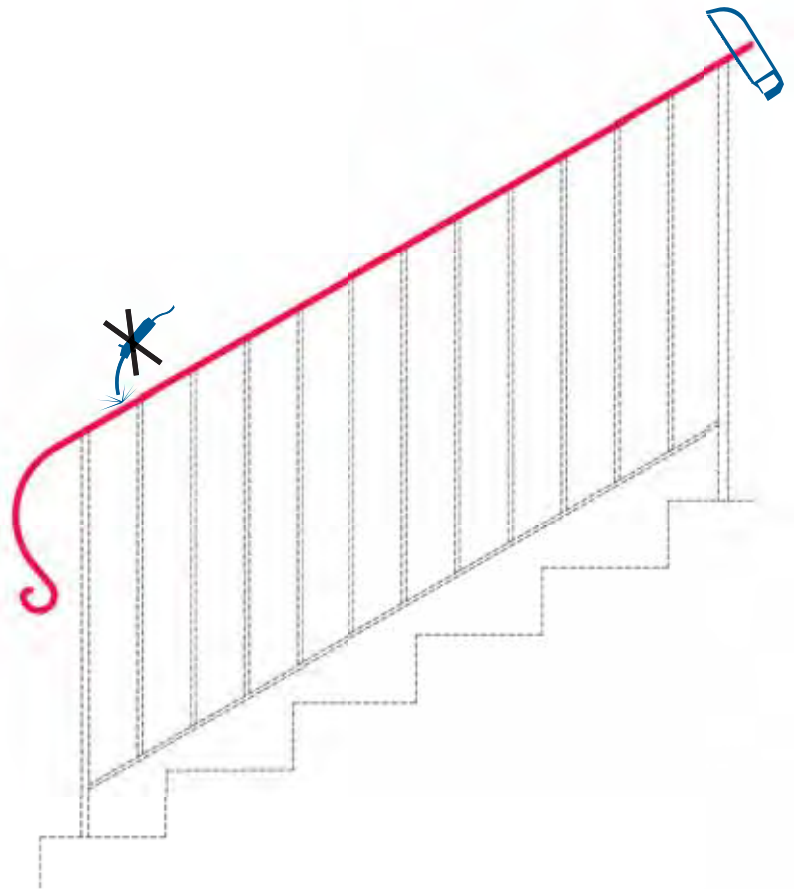

Martellato / Hammered  
Art.12.P1.013  $\neq$  40 x 8 mm

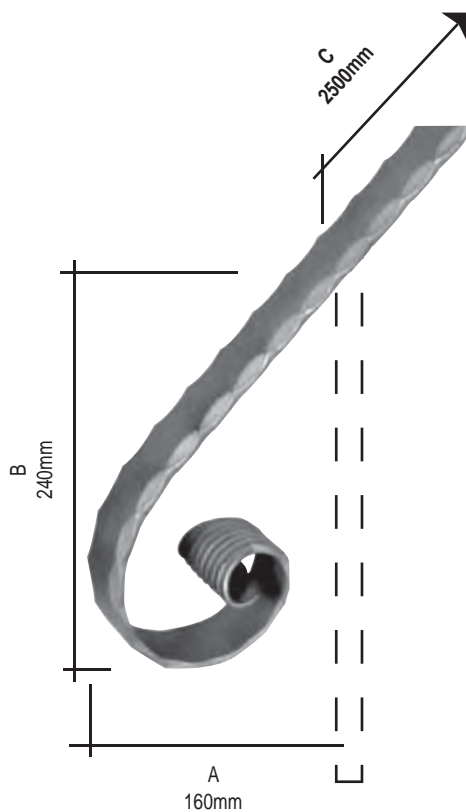

Martellato / Hammered  
Art.12.P1.015  $\neq$  40 x 8 mm

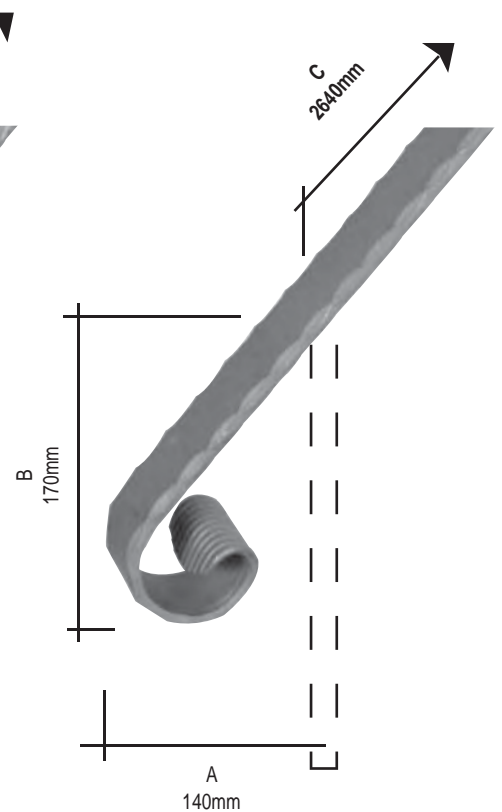

Martellato / Hammered  
Art.12.P1.017  $\neq$  40 x 8 mm  
Art.12.P1.018  $\neq$  50 x 10 mm



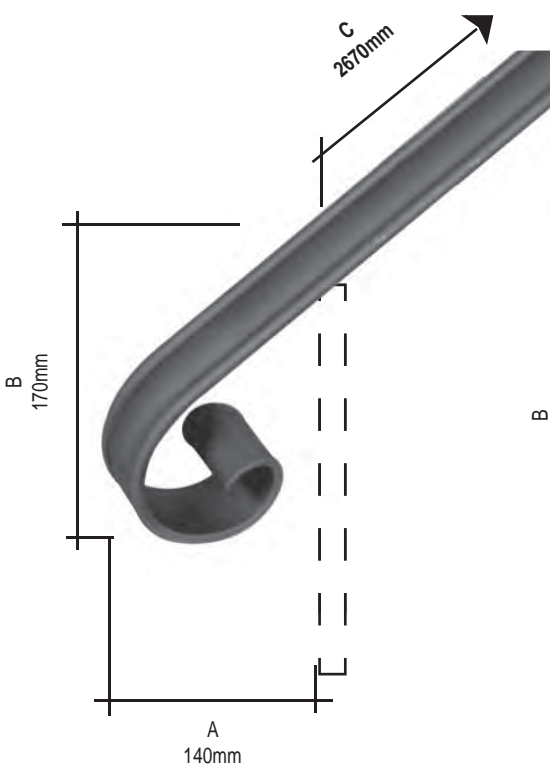

**Art.12.P1.056** 40 x 8 mm

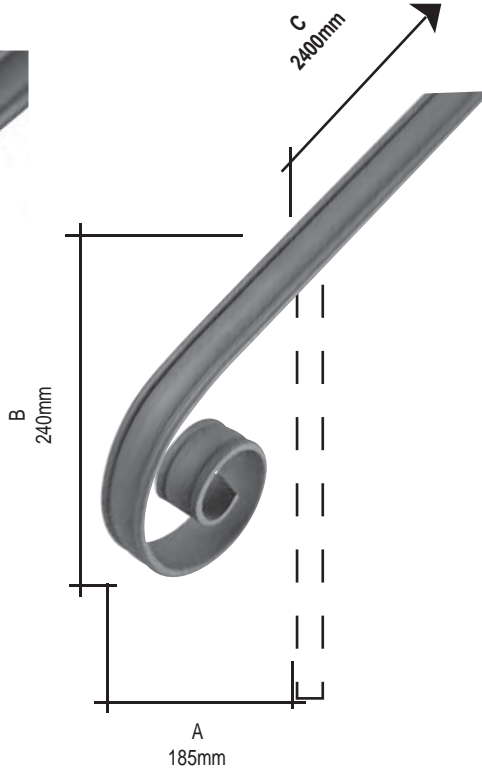

**Art.12.P1.056.01** 40 x 8 mm

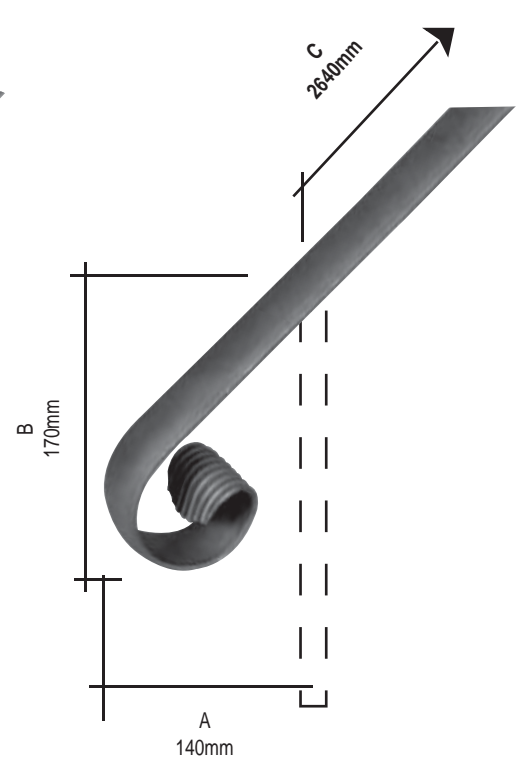

**Art.12.P1.072** 40 x 8 mm  
**Art.12.P1.073** 40 x 10 mm  
**Art.12.P1.074** 40 x 12 mm  
**Art.12.P1.075** 50 x 10 mm

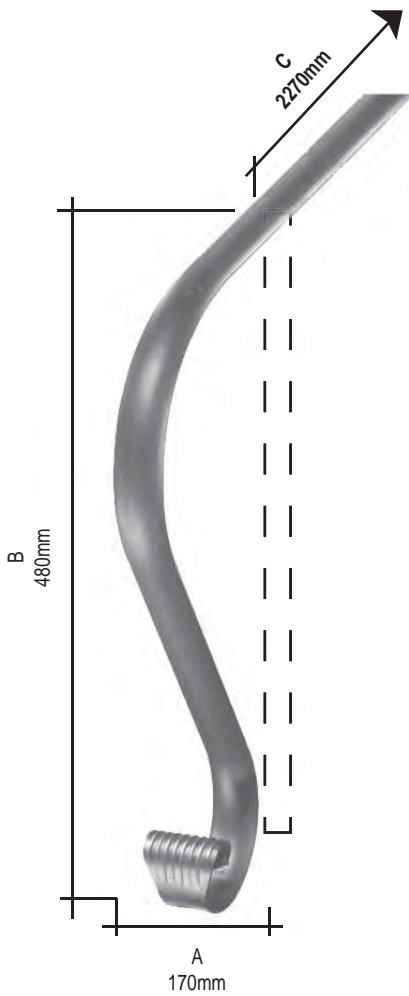

**Art.12.P1.078.01** 40 x 10 mm  
**Art.12.P1.079** 40 x 12 mm

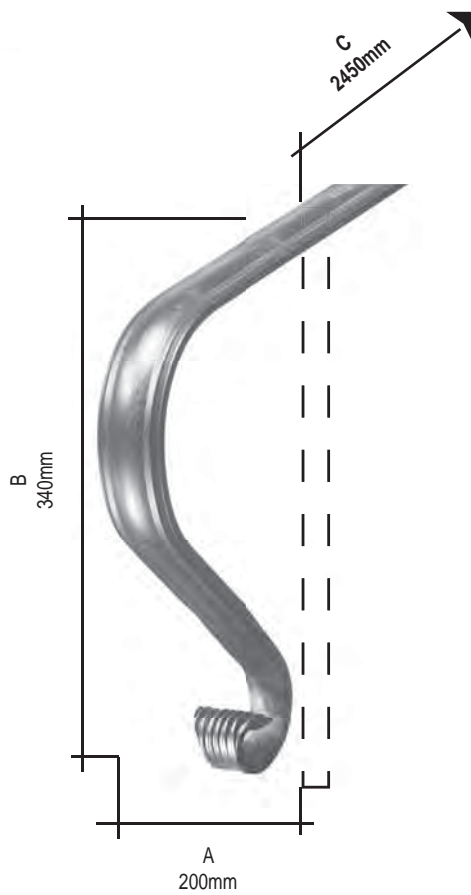

**Art.12.P1.086** 50 x 14 mm  
**Art.12.P1.086.01** 40 x 12 mm  
**Art.12.P1.086.02** 45 x 12 mm

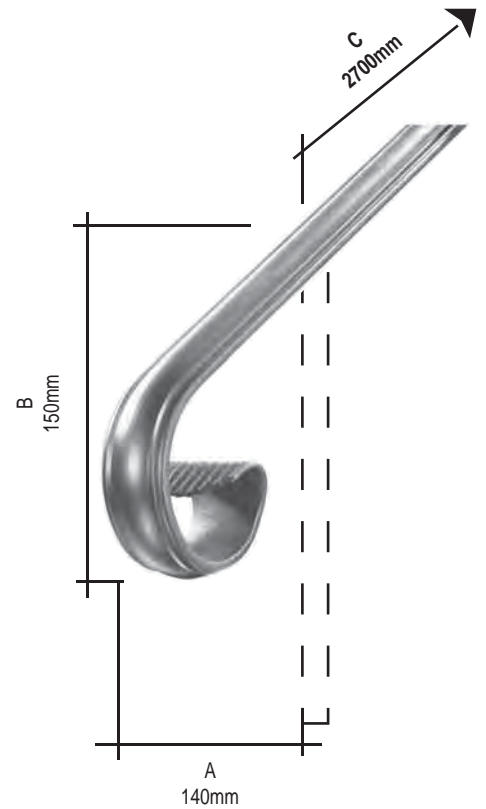

**Art.12.P1.086.12** 50 x 14 mm  
**Art.12.P1.086.13** 40 x 12 mm  
**Art.12.P1.086.14** 45 x 12 mm  
**Art.12.P1.086.15** 60 x 16 mm

Tutte le parti di questo catalogo - foto comprese - sono di proprietà Euro-Fer. La riproduzione, anche parziale, è vietata in ogni forma e con ogni mezzo. / Every part of this catalogue - photos included - is Euro-Fer's property. All forms of copying are strictly prohibited.

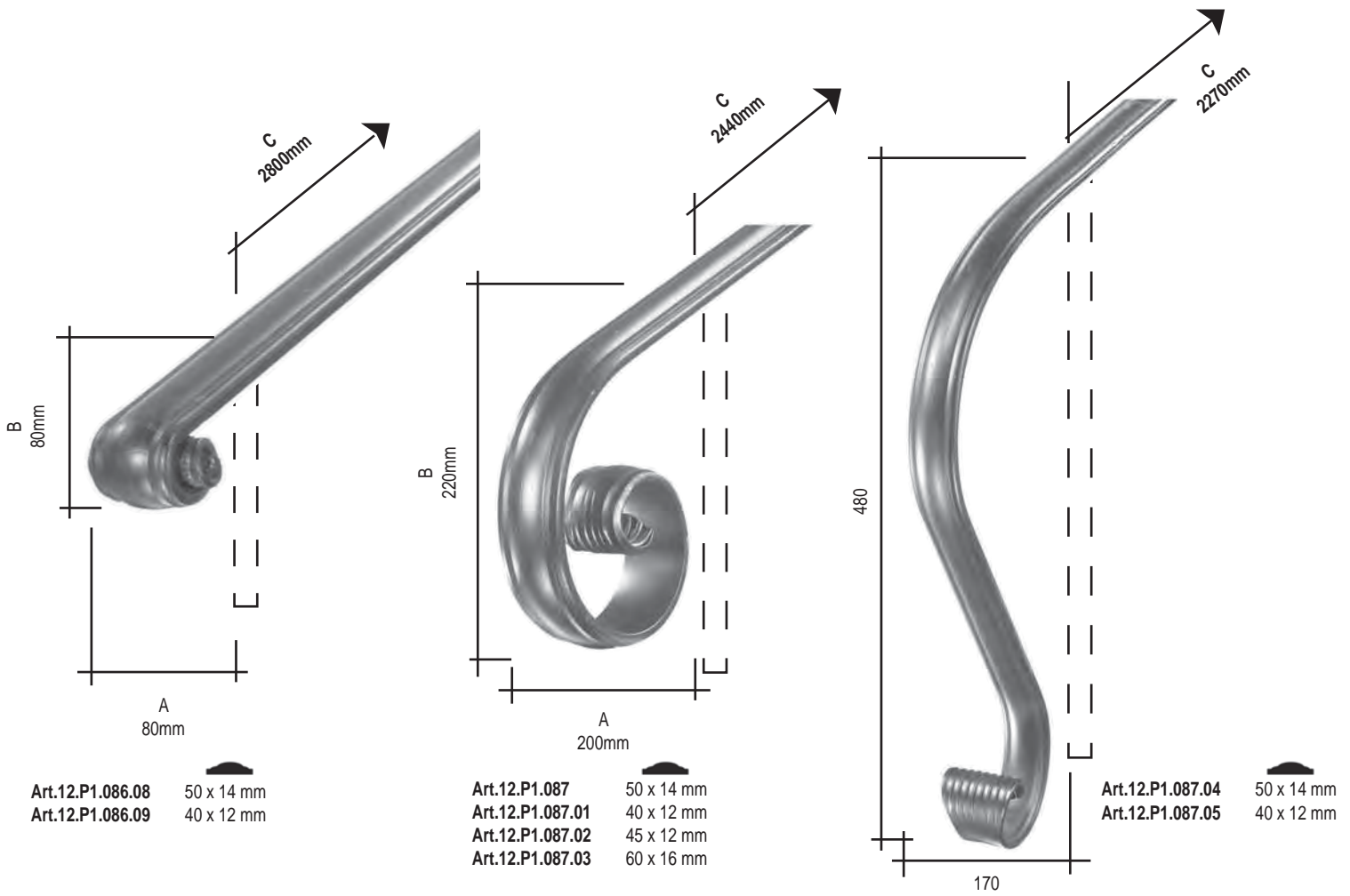

			<b>C</b>
<input type="checkbox"/>	<b>Art.12.P1.013</b>	40 x 8 mm	2680 mm
<input type="checkbox"/>	<b>Art.12.P1.015</b>	40 x 8 mm	2500 mm
<input type="checkbox"/>	<b>Art.12.P1.017</b>	40 x 8 mm	2640 mm
<input type="checkbox"/>	<b>Art.12.P1.018</b>	50 x 10 mm	2640 mm
<input type="checkbox"/>	<b>Art.12.P1.056</b>	40 x 8 mm	2670 mm
<input type="checkbox"/>	<b>Art.12.P1.056.01</b>	40 x 8 mm	2400 mm
<input type="checkbox"/>	<b>Art.12.P1.072</b>	40 x 8 mm	2640 mm
<input type="checkbox"/>	<b>Art.12.P1.073</b>	40 x 10 mm	2640 mm
<input type="checkbox"/>	<b>Art.12.P1.074</b>	40 x 12 mm	2640 mm
<input type="checkbox"/>	<b>Art.12.P1.075</b>	50 x 10 mm	2640 mm
<input type="checkbox"/>	<b>Art.12.P1.078.01</b>	40 x 10 mm	2270 mm
<input type="checkbox"/>	<b>Art.12.P1.079</b>	40 x 12 mm	2270 mm
<input type="checkbox"/>	<b>Art.12.P1.086</b>	50 x 14 mm	2450 mm
<input type="checkbox"/>	<b>Art.12.P1.086.01</b>	40 x 12 mm	2450 mm
<input type="checkbox"/>	<b>Art.12.P1.086.02</b>	45 x 12 mm	2450 mm
<input type="checkbox"/>	<b>Art.12.P1.086.08</b>	50 x 14 mm	2800 mm
<input type="checkbox"/>	<b>Art.12.P1.086.09</b>	40 x 12 mm	2800 mm
<input type="checkbox"/>	<b>Art.12.P1.086.12</b>	50 x 14 mm	2700 mm
<input type="checkbox"/>	<b>Art.12.P1.086.13</b>	40 x 12 mm	2700 mm
<input type="checkbox"/>	<b>Art.12.P1.086.14</b>	45 x 12 mm	2700 mm
<input type="checkbox"/>	<b>Art.12.P1.086.15</b>	60 x 16 mm	2700 mm
<input type="checkbox"/>	<b>Art.12.P1.087</b>	50 x 14 mm	2440 mm
<input type="checkbox"/>	<b>Art.12.P1.087.01</b>	40 x 12 mm	2440 mm
<input type="checkbox"/>	<b>Art.12.P1.087.02</b>	45 x 12 mm	2440 mm
<input type="checkbox"/>	<b>Art.12.P1.087.03</b>	60 x 16 mm	2440 mm
<input type="checkbox"/>	<b>Art.12.P1.087.04</b>	50 x 14 mm	2270 mm
<input type="checkbox"/>	<b>Art.12.P1.087.05</b>	40 x 12 mm	2270 mm

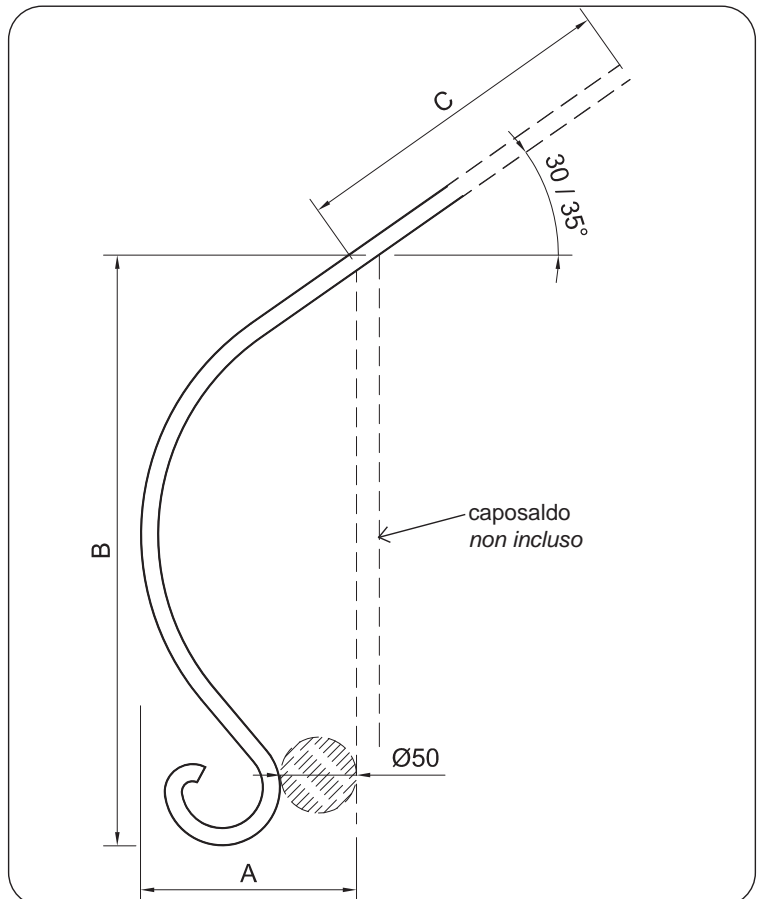







TONDO  
MARTELLATO  
HAMMERED  
ROUND



RIGATO +  
MARTELLATO  
HAMMERED  
FLUTED



QUADRO  
BATTUTO  
4 LATI  
SQUARE BARS  
HAMMERED  
ON 4 SIDES



MODELLO  
CORTECCIA  
BARK MODEL

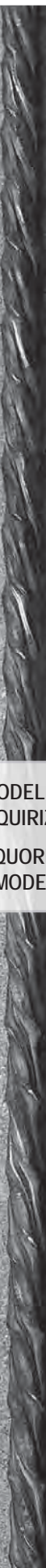

MODELLO  
LIQUIRIZIA  
LIQUORICE  
MODEL



RIGATO  
4 FACCE  
FLUTED  
4 FACES





H.200 mm.

Art. 13.001  12  
Art. 13.002  14  
Art. 13.003  16

Fiamma Grande / Big Flame

Liscio / Smooth  
H.250X L.48 mmArt. 13.001.02  12H.250X L.51 mm  
Art. 13.001.03  14H.250X L.54 mm  
Art. 13.001.04  16

Martellato / Hammered

H.200 mm.

Art. 13.003.01  12  
Art. 13.003.02  14  
Art. 13.003.03  16

Tondo / Round

H.200 mm.

Art. 13.003.04  Ø12  
Art. 13.003.05  Ø14  
Art. 13.003.06  Ø16

Fiamma Grande / Big Flame

Tondo / Round  
H.250X L.48 mmArt. 13.003.07  12H.250X L.51 mm  
Art. 13.003.08  14H.250X L.54 mm  
Art. 13.003.09  16

Fiamma Grande / Big Flame

Martellato / Hammered  
H.250X L.48 mmArt. 13.003.10  12H.250X L.51 mm  
Art. 13.003.11  14H.250X L.54 mm  
Art. 13.003.12  16

H.200 mm.

Art. 13.004  12  
Art. 13.005  14  
Art. 13.006  16

Martellato / Hammered

H.200 mm.

Art. 13.006.01  12  
Art. 13.006.02  14  
Art. 13.006.03  16

Tondo / Round

H.200 mm.

Art. 13.006.04  Ø12  
Art. 13.006.05  Ø14  
Art. 13.006.06  Ø16

H.250 mm.

Art. 13.007  12  
Art. 13.008  14  
Art. 13.009  16

Martellato / Hammered

H.250 mm.

Art. 13.009.01  12  
Art. 13.009.02  14  
Art. 13.009.03  16

Tondo / Round

H.250 mm.

Art. 13.009.04  Ø14  
Art. 13.009.05  Ø16

H.200 mm.

Art. 13.010  12  
Art. 13.011  14  
Art. 13.012  16

Martellato / Hammered

H.200 mm.

Art. 13.012.01  12  
Art. 13.012.02  14  
Art. 13.012.03  16

Tondo / Round

H.200 mm.

Art. 13.012.04  Ø12  
Art. 13.012.05  Ø14  
Art. 13.012.06  Ø16

Fiamma grande / Big flame

Liscio / Smooth  
H.250X L.48 mmArt. 13.012.20  12

H.250X L.51 mm

Art. 13.012.21  14

H.250X L.54 mm

Art. 13.012.22  16

H.250X L.48 mm

Art. 13.012.23  12

H.250X L.51 mm

Art. 13.012.24  14

H.250X L.54 mm

Art. 13.012.25  16

Martellato / Hammered

H.250X L.48 mm

Art. 13.012.26  12

H.250X L.51 mm

Art. 13.012.27  14

H.250X L.54 mm

Art. 13.012.28  16

H.200 mm.

Art. 13.013  12  
Art. 13.014  14  
Art. 13.015  16

Martellato / Hammered

H.200 mm.

Art. 13.015.01  12  
Art. 13.015.02  14  
Art. 13.015.03  16

Tondo / Round

H.200 mm.

Art. 13.015.04  Ø12  
Art. 13.015.05  Ø14  
Art. 13.015.06  Ø16

H.150 mm.

Art. 13.016  12  
Art. 13.017  14  
Art. 13.018  16

Fiamma grande / Big flame

Tondo / Round  
H.250 mm.Art. 13.015.20  Ø12

Martellato / Hammered

H.150 mm.

Art. 13.018.01  12  
Art. 13.018.02  14  
Art. 13.018.03  16

Tondo / Round

H.150 mm.

Art. 13.018.04  Ø12  
Art. 13.018.05  Ø14  
Art. 13.018.06  Ø16

H.200 mm.

Art. 13.018.07  12  
Art. 13.018.08  14  
Art. 13.018.09  16

Martellato / Hammered

H.200 mm.

Art. 13.018.10  12  
Art. 13.018.11  14  
Art. 13.018.12  16

H.200 mm.

Art. 13.018.13  12  
Art. 13.018.14  14  
Art. 13.018.15  16

Martellato / Hammered

H.200 mm.

Art. 13.018.16  12  
Art. 13.018.17  14  
Art. 13.018.18  16



Modello Catania / Catania model



H.200 mm.  
Art. 13.018.19  12  
Art. 13.018.20  14  
Art. 13.018.21  16

Martellato / Hammered  
H.200 mm.  
Art. 13.018.22  12  
Art. 13.018.23  14  
Art. 13.018.24  16

H.200 mm.  
Art. 13.019  12  
Art. 13.020  14  
Art. 13.021  16

H.200 mm.  
Art. 13.022  12  
Art. 13.023  14  
Art. 13.024  16

Liscio / Smooth  
H.200 mm  
Art. 13.024.50  12  
Art. 13.024.51  14  
Art. 13.024.52  16  
Art. 13.024.53  18  
Art. 13.024.54  20

Liscio / Smooth  
H.200 mm  
Art. 13.024.55  12  
Art. 13.024.56  14  
Art. 13.024.57  16  
Art. 13.024.58  18  
Art. 13.024.59  20

Liscio / Smooth  
H.200 mm  
Art. 13.024.100  12  
Art. 13.024.101  14

Liscio / Smooth  
H.200 mm  
Art. 13.024.110  12  
Art. 13.024.111  14

Liscio / Smooth  
H.200 mm

Liscio / Smooth  
H.200 mm

Sfera / Sphere Ø20 Art. 13.024.145 <input type="checkbox"/> 12	Sfera / Sphere Ø35 Art. 13.024.159 <input type="checkbox"/> 12 Art. 13.024.160 <input type="checkbox"/> 16
Sfera / Sphere Ø25 Art. 13.024.150 <input type="checkbox"/> 12 Art. 13.024.151 <input type="checkbox"/> 14 Art. 13.024.153 <input type="checkbox"/> 12	Sfera Forgiata Ø 25 / Forged Sphere Ø 25 Art. 13.024.170 <input type="checkbox"/> 12
Sfera / Sphere Ø30 Art. 13.024.156 <input type="checkbox"/> 12 Art. 13.024.157 <input type="checkbox"/> 14	



H.200 mm. Art. 13.025 <input type="checkbox"/> 12 Art. 13.026 <input type="checkbox"/> 14 Art. 13.027 <input type="checkbox"/> 16 Art. 13.027.01 <input type="checkbox"/> 18	Martellato / Hammered H.200 mm. Art. 13.027.02 <input type="checkbox"/> 12 Art. 13.027.03 <input type="checkbox"/> 14 Art. 13.027.04 <input type="checkbox"/> 16 Art. 13.027.05 <input type="checkbox"/> 18	Tondo / Round H.200 mm. Art. 13.027.06 <input type="checkbox"/> 12 Art. 13.027.07 <input type="checkbox"/> 14 Art. 13.027.08 <input type="checkbox"/> 16 Art. 13.027.09 <input type="checkbox"/> 18 Art. 13.027.10 <input type="checkbox"/> 20
--	--	--

Liscio / Smooth  
H.250 mm

Liscio / Smooth  
H.250 mm

Art. 13.027.40 <input type="checkbox"/> 12 Art. 13.027.41 <input type="checkbox"/> 14	Art. 13.027.43 <input type="checkbox"/> 12 Art. 13.027.44 <input type="checkbox"/> 14 Art. 13.027.45 <input type="checkbox"/> 16
--	--



Art. 13.027.50 <input type="checkbox"/> 12 Art. 13.027.51 <input type="checkbox"/> 14 Art. 13.027.52 <input type="checkbox"/> 16	Art. 13.027.55 <input type="checkbox"/> 12 Art. 13.027.56 <input type="checkbox"/> 14 Art. 13.027.57 <input type="checkbox"/> 16
--	--

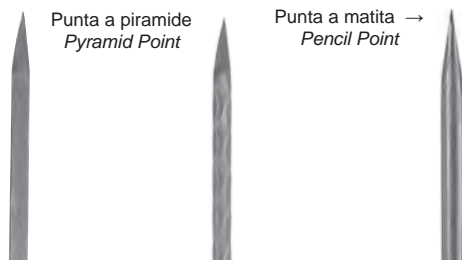

H.200 mm. Art. 13.028 <input type="checkbox"/> 12 Art. 13.029 <input type="checkbox"/> 14 Art. 13.030 <input type="checkbox"/> 16 Art. 13.030.01 <input type="checkbox"/> 18 Art. 13.030.02 <input type="checkbox"/> 20	Martellato / Hammered H.200 mm. Art. 13.030.03 <input type="checkbox"/> 12 Art. 13.030.04 <input type="checkbox"/> 14 Art. 13.030.05 <input type="checkbox"/> 16 Art. 13.030.06 <input type="checkbox"/> 18 Art. 13.030.07 <input type="checkbox"/> 20	Tondo / Round H.200 mm. Art. 13.030.08 <input type="checkbox"/> 12 Art. 13.030.09 <input type="checkbox"/> 14 Art. 13.030.10 <input type="checkbox"/> 16 Art. 13.030.11 <input type="checkbox"/> 18 Art. 13.030.12 <input type="checkbox"/> 20
--	--	--



Art. 13.030.13 <input type="checkbox"/> 12 Art. 13.030.14 <input type="checkbox"/> 14 Art. 13.030.15 <input type="checkbox"/> 16	Art. 13.030.16 <input type="checkbox"/> 12 Art. 13.030.17 <input type="checkbox"/> 14 Art. 13.030.18 <input type="checkbox"/> 16	Art. 13.030.19 <input type="checkbox"/> 12 Art. 13.030.20 <input type="checkbox"/> 14 Art. 13.030.21 <input type="checkbox"/> 16
--	--	--

H.230 mm.  
Art. 13.031  14

H.250 mm.  
Art. 13.031.01  12  
Art. 13.031.02  16  
Art. 13.031.03  12 **NEW**  
Art. 13.031.04  14  
Art. 13.031.05  16

H.300 mm.  
Art. 13.031.50  12  
Art. 13.031.51  14  
Art. 13.031.52  16  
Art. 13.031.53  12  
Art. 13.031.54  14  
Art. 13.031.55  16

**NEW**

Pallina Grande / Large Ball  
H.200 mm.  
Art. 13.031.70  12  
Art. 13.031.71  14 **NEW**  
Art. 13.031.72  16

H.230 mm.  
Art. 13.032  14

H.1400 mm.  
Art. 13.031.73  14 **NEW**

H.1700 mm.  
Art. 13.031.74  14 **NEW**

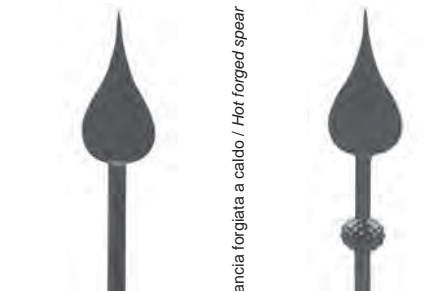

L.75 mm. Art. 13.032.04 <input type="checkbox"/> 16 H.290 Art. 13.032.06 <input type="checkbox"/> 12 H.270 Art. 13.032.07 <input type="checkbox"/> 14 H.280 Art. 13.032.08 <input type="checkbox"/> 18 H.310	L.75 mm. Art. 13.032.09 <input type="checkbox"/> 12 H.270 Art. 13.032.10 <input type="checkbox"/> 14 H.280 Art. 13.032.11 <input type="checkbox"/> 16 H.290 Art. 13.032.12 <input type="checkbox"/> 18 H.310
--	--

Tutte le parti di questo catalogo - foto comprese - sono di proprietà Euro-Fer. La riproduzione, anche parziale, è vietata in ogni forma e con ogni mezzo. / Every part of this catalogue - photos included - is Euro-Fer's property. All forms of copying are strictly prohibited.

**NEW** **NEW**

H.230 mm. Art. 13.033 □ 14 Art. 13.033.01 □ 16 Art. 13.033.02 □ 12	Martellato / Hammered H.230 mm. Art. 13.033.03 □ 12 Art. 13.033.04 □ 14 Art. 13.033.05 □ 16	Tondo / Round H.230 mm. Art. 13.033.06 Ø 12 Art. 13.033.07 Ø 14 Art. 13.033.08 Ø 16	H.270 mm. Art. 13.033.10 □ 12 Art. 13.033.11 □ 14 Art. 13.033.12 □ 16 Art. 13.033.13 Ø 12 Art. 13.033.14 Ø 14 Art. 13.033.15 Ø 16	H.300 mm. Art. 13.033.50 □ 12 Art. 13.033.51 □ 14 Art. 13.033.52 □ 16 Art. 13.033.53 Ø 12 Art. 13.033.54 Ø 14 Art. 13.033.55 Ø 16
---	---	---	---	---

PALLINE GRANDI / LARGE BALLS

H.230 mm. Art. 13.034.50 □ 12 <b>Art. 13.034.49 □ 16</b> Art. 13.035 □ 14 Art. 13.034.46 Ø 12 Art. 13.034.47 Ø 14 Art. 13.034.48 Ø 16	H.180 mm. Art. 13.035.01 □ 12 Art. 13.035.02 □ 14 Art. 13.035.03 □ 16	Martellato / Hammered H.180 mm. Art. 13.035.04 □ 12 Art. 13.035.05 □ 14 Art. 13.035.06 □ 16	Tondo / Round H.180 mm. Art. 13.035.07 Ø 12 Art. 13.035.08 Ø 14 Art. 13.035.09 Ø 16	H.230 mm. Art. 13.035.10 □ 12 Art. 13.035.11 □ 14 Art. 13.035.12 □ 16 Art. 13.035.13 □ 18	Martellato / Hammered H.230 mm. Art. 13.035.14 □ 12 Art. 13.035.15 □ 14 Art. 13.035.16 □ 16 Art. 13.035.17 □ 18	Tondo / Round H.230 mm. Art. 13.035.19 Ø 12 Art. 13.035.20 Ø 16 Art. 13.035.21 Ø 18	H.230 mm. Art. 13.035.22 □ 12 Art. 13.035.23 □ 14 Art. 13.035.24 □ 16 Art. 13.035.25 □ 18
---	--	---	---	---	--	---	---

H.250 mm. Art. 13.035.26 □ 14 Art. 13.035.27 □ 16	Martellato / Hammered H.250 mm. Art. 13.035.28 □ 14 Art. 13.035.29 □ 16	Tondo / Round H.250 mm. Art. 13.035.30 Ø 14 Art. 13.035.31 Ø 16	Fascetta inserita a caldo Hot-inserted clip H.250 mm. Art. 13.035.32 □ 14 Art. 13.035.33 □ 16	Fascetta inserita a caldo Hot-inserted clip Martellato / Hammered H.250 mm. Art. 13.035.34 □ 14 Art. 13.035.35 □ 16	Fascetta inserita a caldo Hot-inserted clip Tondo / Round H.250 mm. Art. 13.035.36 Ø 14 Art. 13.035.37 Ø 16	Martellato / Hammered H.280 mm. Art. 13.035.38 □ 14 Art. 13.035.39 □ 16 Art. 13.035.40 □ 18	Martellato / Hammered H.280 mm. Art. 13.035.41 □ 14 Art. 13.035.42 □ 16 Art. 13.035.43 □ 18
---	--	--	---	--	--	---	---

PALLINE PICCOLE / SMALL BALLS

Tondo / Round H.280 mm. Art. 13.035.44 Ø 14 Art. 13.035.45 Ø 16 Art. 13.035.46 Ø 18	Tondo Lavorato Worked Round Bar H.280 mm. Art. 13.035.47 Ø 14 Art. 13.035.48 Ø 16 Art. 13.035.49 Ø 18	Tondo / Round H.250 mm. Art. 13.035.50 Ø 12 Art. 13.035.51 Ø 14	Quadro / Square H.250 mm. Art. 13.035.52 □ 12 Art. 13.035.53 □ 14	Quadro / Square H.250 mm. Art. 13.035.54 □ 12 Art. 13.035.55 □ 14	Tondo / Round H.250 mm. Art. 13.035.56 Ø 12 Art. 13.035.57 Ø 14	Martellato / Hammered H.200 mm. Art. 13.035.58 □ 12 Art. 13.035.59 □ 14 Art. 13.035.60 □ 16 Art. 13.035.61 □ 18 Art. 13.035.62 □ 20	Martellato / Hammered H.200 mm. Art. 13.035.63 □ 12 Art. 13.035.64 □ 14 Art. 13.035.65 □ 16 Art. 13.035.66 □ 18 Art. 13.035.67 □ 20	Tondo / Round H.200 mm. Art. 13.035.68 Ø 12 Art. 13.035.69 Ø 14 Art. 13.035.70 Ø 16 Art. 13.035.71 Ø 18
---	--	--	--	--	--	---	---	--

Tutte le parti di questo catalogo - foto comprese - sono di proprietà Euro-Fer. La riproduzione, anche parziale, è vietata in ogni forma e con ogni mezzo. / Every part of this catalogue - photos included - is Euro-Fer's property. All forms of copying are strictly prohibited.





Pallina piccola / Small ball  
Liscio / Smooth  
H.200 mm  
Art. 13.035.80 □ 12  
Art. 13.035.81 □ 14  
Art. 13.035.82 □ 16



Pallina piccola / Small ball  
Martellato / Hammered  
H.200 mm  
Art. 13.035.85 □ 12  
Art. 13.035.86 □ 14  
Art. 13.035.87 □ 16

Modello mezza luna / Half moon model



Liscio / Smooth  
H. 190 X L.120 mm  
Art. 13.035.100  
2 x ≠ 16 X 8 mm  
Art. 13.035.101  
2 x ≠ 12 X 6 mm



Liscio / Smooth  
H. 210 X L.130 mm  
Art. 13.035.110  
2 x ≠ 16 X 8 mm  
Art. 13.035.111  
2 x ≠ 12 X 6 mm



Schiacciata sullo spigolo / Ornament on the edge  
H.200 mm  
Art. 13.035.140 □ 12  
Art. 13.035.141 □ 14  
Art. 13.035.142 □ 16  
Liscio / Smooth



Martellato / Hammered  
H.200 mm  
Art. 13.035.150 □ 12  
Art. 13.035.151 □ 14  
Art. 13.035.152 □ 16



Liscio / Smooth  
H.200 mm  
Art. 13.035.153 □ 12  
Art. 13.035.154 □ 14  
Art. 13.035.155 □ 16



Liscio / Smooth  
H.200 mm  
Art. 13.035.300  
≠ 25 x 8 mm  
Art. 13.035.301  
≠ 30 x 8 mm



H.150 X L.40 mm.  
Art. 13.036 □ 12



H.180 X L.45 mm.  
Art. 13.037 □ 14



H.190 X L.50 mm.  
Art. 13.038 □ 16



H.200 X L.55 mm.  
Art. 13.039 □ 18



H.210 X L.62 mm.  
Art. 13.040 □ 20



H.125 X L.60 mm.  
Art. 13.041 Ø 13



H.155 X L.70 mm.  
Art. 13.042 Ø 16



H.190 X L.90 mm.  
Art. 13.043 Ø 16



H.130 X L.50 mm.  
Art. 13.044 Ø 15



H.130 X L.53 mm.  
Art. 13.045 Ø 13



H.160 X L.65 mm.  
Art. 13.046 Ø 17



H.195 X L.75 mm.  
Art. 13.047 Ø 17



H.110 X L.60 mm.  
Art. 13.048 Ø 20

Fornite con inserto di plastica separato / Provided with separate plastic thread

Esempio di utilizzo  
Example of use

H.125 X L.58 mm.  
Art. 13.051.01  
Fuori Produzione  
Out of Production  
base Ø 12,5 mm.

H.155 X L.70 mm.  
Art. 13.051.03  
Fuori Produzione  
Out of Production  
base Ø 16,5 mm.

H.125 X L.60 mm.  
Art. 13.051.05  
Fuori Produzione  
Out of Production  
base Ø 12,5 mm.

H.155 X L.70 mm.  
Art. 13.051.07  
base Ø 30 mm.  
foro Ø 16,5 mm.

Art. 13.051.02  
Fuori Produzione  
Out of Production  
base Ø 12,5 mm.

Art. 13.051.04  
Fuori Produzione  
Out of Production  
base Ø 14,5 mm.

Art. 13.051.06  
base Ø 26 mm.  
foro □ 12,5 mm.

Art. 13.051.08  
base Ø 30 mm.  
foro □ 14,5 mm.

Tutte le parti di questo catalogo - foto comprese - sono di proprietà Euro-Fer. La riproduzione, anche parziale, è vietata in ogni forma e con ogni mezzo. / Every part of this catalogue - photos included - is Euro-Fer's property. All forms of copying are strictly prohibited.



H.130 X L.60 mm.  
Art. 13.052 Ø12



H.130 X L.60 mm.  
Art. 13.052.01 Ø12



H.130 X L.60 mm.  
Art. 13.052.02  
base Ø 12 mm.



H.155 X L.70 mm.  
Art. 13.053 Ø 17



H.190 X L.95 mm.  
Art. 13.054 Ø 20



H.80 X L.45 mm.  
Art. 13.055 Ø 20



H.78 X L.45 mm.  
Art. 13.055.F12 Ø 12



H.125 X L.65 mm.  
Art. 13.056 Ø 25



H.140 X L.80 mm.  
Art. 13.057 Ø 38



H.120 X L.55 mm.  
Art. 13.058 Ø 20



H.135 X L.65 mm.  
Art. 13.059 Ø 25



H.125 X L.63 mm.  
Art. 13.059.01 Ø 24

H.138 X L.67 mm.  
Art. 13.059.02 Ø 25  
H.163 X L.83 mm.  
Art. 13.059.03 Ø 30



H.115 X L.58 mm.  
Art. 13.060 Ø 20



H.115 X L.58 mm.  
Art. 13.060.02  
base Ø 21,5 mm.

H.140 X L.70 mm.  
Art. 13.061.02  
base Ø 26 mm.



H.113 X L.57 mm.  
Art. 13.060.F12 Ø 12



H.140 X L.70 mm.  
Art. 13.061 Ø 26



H.70 X L.60 mm.  
Art. 13.062 □ 12



H.130 X L.60 mm.  
Art. 13.063.01 □ 14

Decorazioni con vetro colorato / Coloured glass decorations



H.140 X L.60 mm.  
Art. 13.064 ≙ 14X 8



H.125 mm.  
Art. 13.064.01  
base Ø 15 mm.  
H.100 mm.  
Art. 13.064.02  
base Ø 12 mm.



H.125 mm.  
Art. 13.064.03  
base Ø 15 mm.  
H.100 mm.  
Art. 13.064.04  
base Ø 12 mm.



H.120 X L.42 mm.  
Art. 13.065 □12  
H.140 X L.46 mm.  
Art. 13.066 □14



H.150 mm.  
Art. 13.067 □ 14



H.125 mm. - base Ø 15 mm.  
Art. 13.067.01 Rosso / Red  
Art. 13.067.02 Azzurro Int. / Intense Azure  
Art. 13.067.03 Verde Smeraldo / Green  
Art. 13.067.04 Giallo Vivace / Vivid Yellow  
Art. 13.067.06 Blu Oltremare / Dark Blue



H.100 mm. - base Ø 12 mm.  
Art. 13.067.07 Rosso / Red  
Art. 13.067.09 Verde Smeraldo / Green



H.170 X L.52 mm.  
Art. 13.068 □ 14



H.150 X L.45 mm.  
Art. 13.070 □ 14  
base Ø28



H.150 X L.40 mm.  
Art. 13.070.01  
base □ 16



H.125 X L.40 mm.  
Art. 13.071 Ø 25



H.135 X L.40 mm.  
Art. 13.072 Ø 25



H.160 X L.50 mm.  
Art. 13.073 Ø 30



H.190 X L.55 mm.  
Art. 13.074 Ø 32



H.175 X L.60 mm.  
Art. 13.075 Ø 35



H.195 X L.55 mm.  
Art. 13.076 Ø 38

Tutte le parti di questo catalogo - foto comprese - sono di proprietà Euro-Fer. La riproduzione, anche parziale, è vietata in ogni forma e con ogni mezzo. / Every part of this catalogue - photos included - is Euro-Fer's property. All forms of copying are strictly prohibited.



H.125 X L.60 mm.  
Art. 13.077 Ø 32



H.110 mm.  
Art. 13.077.01  
base Ø 25 mm.



H.110 mm.  
Art. 13.077.02  
base Ø 25 mm.



H.110 X L.60 mm.  
Art. 13.077.04



H.125 X L.65 mm.  
Art. 13.077.05



H.140 X L.70 mm.  
Art. 13.077.06



H.140 X L.60 mm.  
Art. 13.078 □ 15



H.130 X L.70 mm.  
Art. 13.079 □ 20

H.125 mm.  
Art. 13.077.03  
base Ø 32 mm.



H.155 X L.65 mm.  
Art. 13.080 Ø 16



H.190 mm.  
Art. 13.080.01  
base Ø 35 mm.



H.200 mm.  
Art. 13.080.03  
base Ø 32 mm.



H.150 mm.  
Art. 13.080.07  
base Ø 16 mm.



H.125 X L.45 mm.  
Art. 13.083 Ø 25



H.140 X L.57 mm.  
Art. 13.084 Ø 33



H.190 X L.68 mm.  
Art. 13.085 Ø 40

H.142 mm.  
Art. 13.080.02  
base Ø 28 mm.

H.160 mm.  
Art. 13.080.04  
base Ø 26 mm.

H.110 mm.  
Art. 13.080.06  
base Ø 18 mm.

H.125 x L.50 mm  
Art. 13.080.08 Ø 25 mm



H.133 mm.  
Art. 13.085.01  
base □ 20



H.260 X L.24 mm.  
Art. 13.086 Ø 17



H.260 mm.  
Art. 13.086.01  
base Ø 50 mm.



H.150 mm.  
Art. 13.086.03  
base Ø 30 mm.



H.110 X L.36 mm.  
Art. 13.086.04  
base Ø 25 mm.



H.200 mm.  
Art. 13.086.05 Ø 12  
Art. 13.086.06 Ø 14  
Art. 13.086.09 Ø 25



H.110 X L.27 mm.  
Art. 13.087 Ø 27



H.130 x L.32 mm  
Art. 13.087.01 □ 30

H.180 mm.  
Art. 13.086.02  
base Ø 35 mm.



H.150 mm.  
Art. 13.090.01  
base □ 40 mm.

H.125 mm.  
Art. 13.090.03  
base □ 25 mm.



H.125 X L.32 mm.  
Art. 13.088 Ø 32



H.160 X L.25 mm.  
Art. 13.089 □ 25



H.120 mm.  
Art. 13.089.01  
base □ 18



H.150 X L.40 mm.  
Art. 13.090 □ 40

H.135 mm.  
Art. 13.090.02  
base □ 32 mm.

H.100 mm.  
Art. 13.090.04  
base □ 20 mm.



H.125 X L.30 mm.  
Art. 13.091  
base □ 20 mm.  
quadrello □ 10 mm.



H.125 X L.30 mm.  
Art. 13.092 □ 20



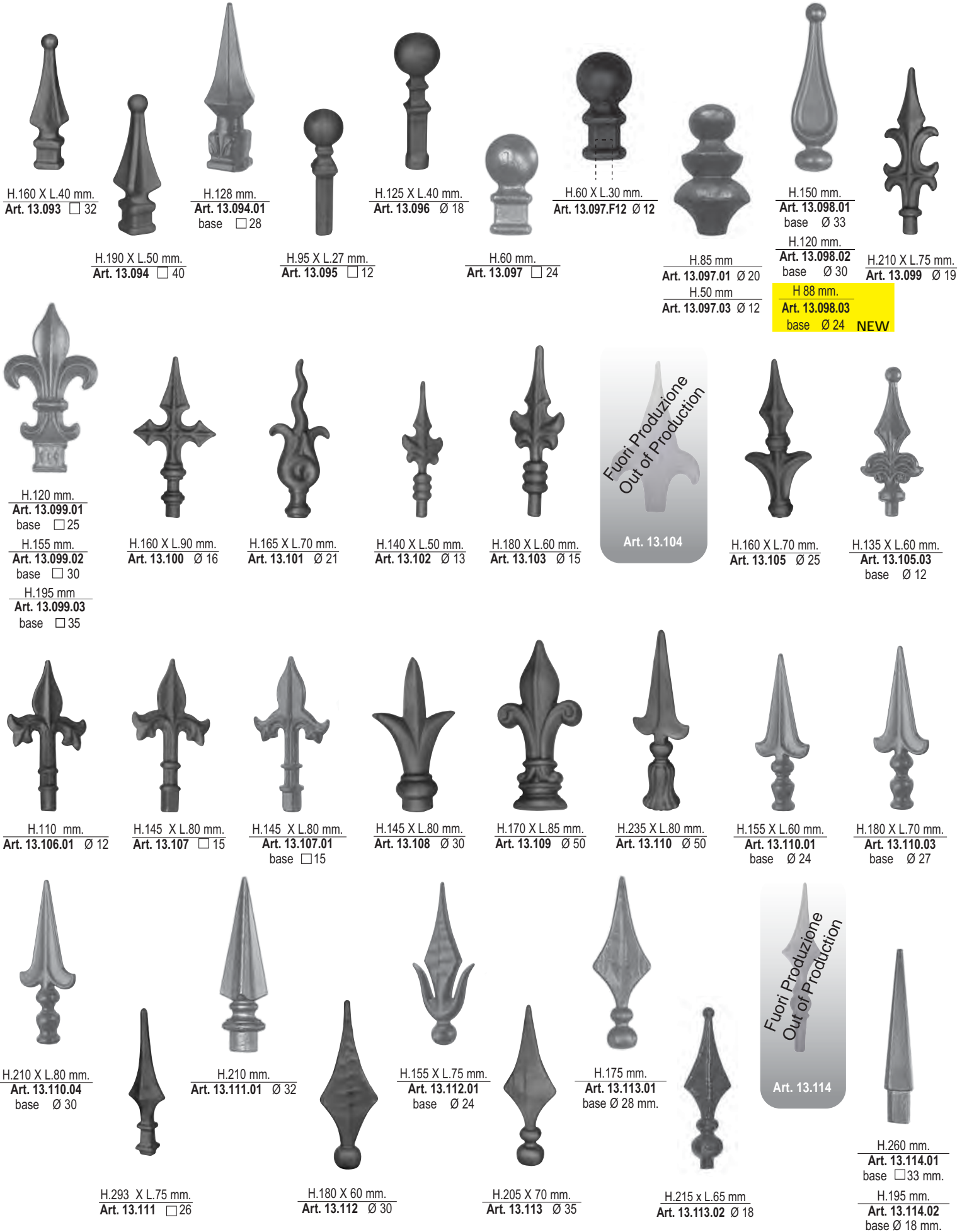

H.160 X L.40 mm.  
Art. 13.093 □ 32

H.128 mm.  
Art. 13.094.01  
base □ 28

H.125 X L.40 mm.  
Art. 13.096 Ø 18

H.60 X L.30 mm.  
Art. 13.097.F12 Ø 12

H.150 mm.  
Art. 13.098.01  
base Ø 33

H.210 X L.75 mm.  
Art. 13.099 Ø 19

H.190 X L.50 mm.  
Art. 13.094 □ 40

H.95 X L.27 mm.  
Art. 13.095 □ 12

H.60 mm.  
Art. 13.097 □ 24

H.85 mm  
Art. 13.097.01 Ø 20

H.50 mm  
Art. 13.097.03 Ø 12

H.120 mm.  
Art. 13.098.02  
base Ø 30

H 88 mm.  
Art. 13.098.03  
base Ø 24 **NEW**

H.120 mm.  
Art. 13.099.01  
base □ 25

H.155 mm.  
Art. 13.099.02  
base □ 30

H.195 mm  
Art. 13.099.03  
base □ 35

H.160 X L.90 mm.  
Art. 13.100 Ø 16

H.165 X L.70 mm.  
Art. 13.101 Ø 21

H.140 X L.50 mm.  
Art. 13.102 Ø 13

H.180 X L.60 mm.  
Art. 13.103 Ø 15

Fuori Produzione  
Out of Production  
Art. 13.104

H.160 X L.70 mm.  
Art. 13.105 Ø 25

H.135 X L.60 mm.  
Art. 13.105.03  
base Ø 12

H.110 mm.  
Art. 13.106.01 Ø 12

H.145 X L.80 mm.  
Art. 13.107 □ 15

H.145 X L.80 mm.  
Art. 13.107.01  
base □ 15

H.145 X L.80 mm.  
Art. 13.108 Ø 30

H.170 X L.85 mm.  
Art. 13.109 Ø 50

H.235 X L.80 mm.  
Art. 13.110 Ø 50

H.155 X L.60 mm.  
Art. 13.110.01  
base Ø 24

H.180 X L.70 mm.  
Art. 13.110.03  
base Ø 27

H.210 X L.80 mm.  
Art. 13.110.04  
base Ø 30

H.210 mm.  
Art. 13.111.01 Ø 32

H.155 X L.75 mm.  
Art. 13.112.01  
base Ø 24

H.175 mm.  
Art. 13.113.01  
base Ø 28 mm.

Fuori Produzione  
Out of Production  
Art. 13.114

H.293 X L.75 mm.  
Art. 13.111 □ 26

H.180 X 60 mm.  
Art. 13.112 Ø 30

H.205 X 70 mm.  
Art. 13.113 Ø 35

H.215 X L.65 mm  
Art. 13.113.02 Ø 18

H.260 mm.  
Art. 13.114.01  
base □ 33 mm.

H.195 mm.  
Art. 13.114.02  
base Ø 18 mm.

Tutte le parti di questo catalogo - foto comprese - sono di proprietà Euro-Fer. La riproduzione, anche parziale, è vietata in ogni forma e con ogni mezzo. / Every part of this catalogue - photos included - is Euro-Fer's property . All forms of copying are strictly prohibited.



H.135 X L.48 mm.  
Art. 13.115 Ø 29



H.165 X L.53 mm.  
Art. 13.116 Ø 29



H.180 X L.55 mm.  
Art. 13.117 Ø 29



H.170 X L.58 mm.  
Art. 13.117.01 Ø 30

H.138 X L.53 mm.  
Art. 13.115.01 Ø 28

H.160 X L.56 mm.  
Art. 13.116.01 Ø 28



H.205 X L.62 mm.  
Art. 13.118 Ø 35



H.243 X L.72 mm.  
Art. 13.119 Ø 40



H.95 X L.40 mm.  
Art. 13.120  
base ≙ 12 X 4



H.140 X L.55 mm.  
Art. 13.121  
base ≙ 15 X 4



H.170 X L.60 mm.  
Art. 13.122  
base ≙ 20 X 8



H.180 X L.55 mm.  
Art. 13.123 Ø 37



H.200 X L.55 mm.  
Art. 13.124 Ø 35



H.190 X L.55 mm.  
Art. 13.125 Ø 30



H.130 X L.47 mm.  
Art. 13.126 Ø 33



H.130 X L.33 mm.  
Art. 13.127 Ø 30



H.135 X L.30 mm.  
Art. 13.128 □ 30



H.145 mm.  
Art. 13.129 □ 25  
Art. 13.130 □ 30



H.155 mm.  
Liscio / Smooth  
Art. 13.131 □ 35  
Art. 13.132 □ 40



H.155 mm.  
Liscio / Smooth  
Art. 13.131.01 □ 50



H.66 mm.  
Liscio / Smooth  
Art. 13.131.02 □ 29



H.115 X L.30 mm.  
Art. 13.132.01 □ 8



H.220 X L.30 mm.  
Art. 13.132.02 □ 12

**NEW**



H.39 X L.40 mm.  
Art. 13.133



H.67 X L.40 mm.  
Art. 13.134



H.39 X L.40 mm.  
Art. 13.135 Ø 12,5  
Art. 13.136 Ø 14,5  
Art. 13.137 Ø 16,5

H.36 x L.37 mm  
Art. 13.135.E Ø 12,5  
Art. 13.136.E Ø 14,5  
Art. 13.137.E Ø 16,5

Rullate / Rolled  
H.39 x L.40 mm  
Art. 13.135.R Ø 12,5  
Art. 13.136.R Ø 14,5  
Art. 13.137.R Ø 16,5



Borchie Svasate /  
Countersunk Ironstud  
H.39 x L.40 mm  
Art. 13.135.B Ø 12,5  
Art. 13.136.B Ø 14,5  
Art. 13.137.B Ø 16,5



H.67 X L.40 mm.  
Art. 13.138 Ø 12,5  
Art. 13.139 Ø 14,5  
Art. 13.140 Ø 16,5

H.63 x L.37 mm  
Art. 13.138.E Ø 12,5  
Art. 13.139.E Ø 14,5  
Art. 13.140.E Ø 16,5

Rullate / Rolled  
H.67 x L.40 mm  
Art. 13.138.R Ø 12,5  
Art. 13.139.R Ø 14,5  
Art. 13.140.R Ø 16,5

H.63 x L.38 mm  
Art. 13.140.RE Ø 16,5

**NUOVE BORCHIE IN TUBO / NEW STUDS IN TUBE**



H.39 x L. 40 mm  
Art. TB.13.135 Ø 12,5  
Art. TB.13.136 Ø 14,5  
Art. TB.13.137 Ø 16,5



H.67 x L. 40 mm  
Art. TB.13.138 Ø 12,5  
Art. TB.13.139 Ø 14,5  
Art. TB.13.140 Ø 16,5



H.39 x L. 40 mm  
Art. TB.13.141 □ 12,5



H.67 x L. 40 mm  
Art. TB.13.142 □ 12,5

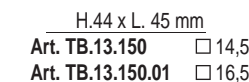

H.44 x L. 45 mm  
Art. TB.13.150 □ 14,5  
Art. TB.13.150.01 □ 16,5

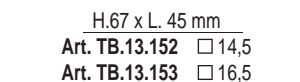

H.67 x L. 45 mm  
Art. TB.13.152 □ 14,5  
Art. TB.13.153 □ 16,5

**Attenzione: Sezione Cava! Eventualmente, avvisare lo zincatore.  
Be Careful: Hole Section! Eventually, inform the galvanizer.**

Tutte le parti di questo catalogo - foto comprese - sono di proprietà Euro-Fer. La riproduzione, anche parziale, è vietata in ogni forma e con ogni mezzo. / Every part of this catalogue - photos included - is Euro-Fer's property. All forms of copying are strictly prohibited.

Articoli in ferro fuso / Cast steel items  
Senza inserto / Without insert



H.65 x L.40 mm  
Art. CS.13.142 □ 12,5



H.67 x L.45 mm  
Art. CS.13.151 □ 12,5  
Art. CS.13.152 □ 14,5  
Art. CS.13.153 □ 16,5



H.39 x L.40 mm  
Art. 13.141 □ 12,5

Rullate / Rolled  
H.39 x L.40 mm  
Art. 13.141.R □ 12,5



H.67 X L.40 mm.  
Art. 13.142 □ 12,5

Rullate / Rolled  
H.67 X L.40 mm.  
Art. 13.142.R □ 12,5

H.63 x L.38 mm  
Art. 13.142.RE □ 12,5



H.44 X L.45 mm.  
Art. 13.143

Rullate / Rolled  
H.44 X L.45 mm.  
Art. 13.143.R



H.67 X L.45 mm.  
Art. 13.144

Rullate / Rolled  
H.67 X L.45 mm.  
Art. 13.144.R



H.44 X L. 45 mm.  
Art. 13.145 Ø 14,5  
Art. 13.146 Ø 16,5  
Art. 13.146.01 Ø 18,5  
Art. 13.146.02 Ø 20,5

Rullate / Rolled  
H.44 X L. 45 mm.  
Art. 13.145.R Ø 14,5  
Art. 13.146.R Ø 16,5  
Art. 13.146.01.R Ø 18,5



H.67 X L. 45 mm.  
Art. 13.147 Ø 14,5  
Art. 13.148 Ø 16,5  
Art. 13.148.01 Ø 18,5  
Art. 13.148.02 Ø 20,5



H.44 X L.45 mm.  
Art. 13.149 □ 12,5  
Art. 13.150 □ 14,5  
Art. 13.150.01 □ 16,5

Rullate / Rolled  
H.67 X L. 45 mm.  
Art. 13.147.R Ø 14,5  
Art. 13.148.R Ø 16,5  
Art. 13.148.01.R Ø 18,5



H.67 X L.45 mm.  
Art. 13.151 □ 12,5  
Art. 13.152 □ 14,5  
Art. 13.153 □ 16,5

Rullate / Rolled  
H.67 X L.45 mm.  
Art. 13.151.R □ 12,5  
Art. 13.152.R □ 14,5  
Art. 13.153.R □ 16,5



H.47 X L.50 mm.  
Art. 13.154

Fuori Produzione  
Out of Production  
Art. 13.155



H.47 X L.50 mm.  
Art. 13.156 Ø 16,5  
Art. 13.157 Ø 18,5  
Art. 13.158 Ø 20,5  
Art. 13.158.01 Ø 22,5



H.80 X L.50 mm.  
Art. 13.159 Ø 16,5  
Art. 13.160 Ø 18,5  
Art. 13.161 Ø 20,5  
Art. 13.161.01 Ø 22,5



H.47 X L.50 mm.  
Art. 13.162 □ 14,5  
Art. 13.163 □ 16,5



H.80 X L.50 mm.  
Art. 13.164 □ 14,5  
Art. 13.165 □ 16,5

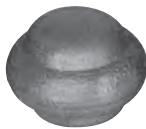

H.25 X L.35 mm.  
Art. 13.166

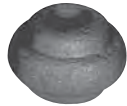

H.25 X L.35 mm.  
Art. 13.167 Ø 12,5  
Art. 13.167.01 Ø 14,5  
Art. 13.167.02 Ø 16,5

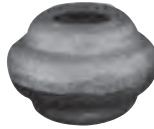

H.25 X L.35 mm.  
Art. 13.167.03 □ 12,5  
Art. 13.167.04 □ 14,5

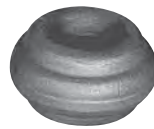

H.22 X L.40 mm.  
Art. 13.168 Ø 14,5  
Art. 13.168.01 Ø 16,5  
Art. 13.168.02 Ø 12,5



H.35 X L.55 mm.  
Art. 13.168.03 Ø 18,5  
Art. 13.168.04 Ø 20,5  
Art. 13.168.05 Ø 25,5  
Art. 13.168.06 Ø 30,5



H.35 X L.55 mm.  
Art. 13.168.07 □ 20,5  
Art. 13.168.08 □ 25,5  
non in produzione  
not in production



H.22 X L.40 mm.  
Art. 13.169 □ 14,5  
Art. 13.169.01 □ 16,5  
Art. 13.169.02 □ 12,5



H.22 X L.33 mm.  
Art. 13.169.03 □ 12,5  
H.22 X L.38 mm.  
Art. 13.169.05 □ 14,5  
Art. 13.169.06 □ 16,5



H.35 X L.55 mm.  
Art. 13.169.07 □ 20,5  
Art. 13.169.08 □ 22,5  
Art. 13.169.09 □ 25,5



H.32 X L.47 mm.  
Art. 13.169.10 □ 12,5  
Art. 13.169.11 □ 14,5  
Art. 13.169.12 □ 16,5  
Art. 13.169.13 □ 18,5



H.60 X L.35 mm.  
Art. 13.170.R



H.30 X L.35 mm.  
Art. 13.170.01.R



H.60 X L.35 mm.  
Art. 13.171.R Ø 14,5  
Art. 13.172.R Ø 16,5  
Art. 13.173.R Ø 18,5  
Art. 13.173.01.R Ø 12,5  
Art. 13.173.02.R □ 12



H.30 X L.35 mm.  
Art. 13.173.03.R Ø 12,5  
Art. 13.173.04.R Ø 14,5  
Art. 13.173.05.R Ø 16,5  
Art. 13.173.06.R Ø 18,5  
Art. 13.173.07.R □ 12



**BORCHIE TORNITE / TURNED BUSHES**



H.24 X L.35 mm.  
Art. 13.173.08 Ø 12,5  
Art. 13.173.09 Ø 14,5  
Art. 13.173.10 Ø 16,5



H.20 X L.40 mm.  
Art. 13.173.11 Ø 12,5  
Art. 13.173.12 Ø 14,5  
Art. 13.173.13 Ø 16,5



H.25 X L.40 mm.  
Art. 13.173.14 Ø 25,5



H.26 X L.35 mm.  
Art. 13.173.15 Ø 12,5  
Art. 13.173.16 Ø 14,5  
Art. 13.173.17 Ø 16,5  
Art. 13.173.18 Ø 18,5



H.60 X L.35 mm.  
Art. 13.173.19 Ø 12,5  
Art. 13.173.20 Ø 14,5  
Art. 13.173.21 Ø 16,5  
Art. 13.173.22 Ø 18,5



H.60 X L.35 mm.  
Art. 13.173.23 Ø 14,5



H.25 X L.35 mm.  
Art. 13.173.24 Ø 14,5



H.25 X L.35 mm.  
Art. 13.173.25 Ø 14,5



H.24 X L.35 mm.  
Art. 13.173.26 Ø 14,5



H.23 X L.35 mm.  
Art. 13.173.27 Ø 14,5



H.7 X L.15 mm.  
Art. 13.173.28  
foro Ø 8



H.55 X L.40 mm.  
Art. 13.175 Ø 14,5  
Art. 13.175.01 Ø 16,5  
Art. 13.175.02 Ø 12,5  
Art. 13.175.03 □ 12



H.52 X L.69 mm.  
Art. 13.176



H.80 X L.69 mm.  
Art. 13.177



H.52 X L.69 mm.  
Art. 13.178 Ø 27,5  
Art. 13.179 Ø 30,5  
Art. 13.180 Ø 35,5  
Art. 13.181 Ø 40,5  
Art. 13.181.01 □ 25,5  
Art. 13.181.02 □ 30,5



H.80 X L.69 mm.  
Art. 13.182 Ø 27,5  
Art. 13.183 Ø 30,5  
Art. 13.184 Ø 35,5  
Art. 13.185 Ø 40,5  
Art. 13.185.01 □ 25,5  
Art. 13.185.02 □ 30,5



H.55 X L.35 mm.  
Art. 13.185.03



H.55 X L.35 mm.  
Art. 13.185.04 Ø 12,5  
Art. 13.185.05 Ø 14,5  
Art. 13.185.06 Ø 16,5  
Art. 13.185.07 Ø 18,5



H.55 X L.35 mm.  
Art. 13.185.08 □ 12,5  
Art. 13.185.09 □ 14,5  
non in produzione  
not in production



H.75 X L.49 mm.  
Art. 13.185.10



H.75 X L.49 mm.  
Art. 13.185.11 Ø 16,5  
Art. 13.185.12 Ø 18,5  
Art. 13.185.13 Ø 20,5  
Art. 13.185.14 Ø 22,5



H.75 X L.49 mm.  
Art. 13.185.15 □ 14,5  
Art. 13.185.16 □ 16,5



H.70 X L.64 mm.  
Art. 13.185.17 □ 16,5  
Art. 13.185.17.01 □ 14,5  
**NEW**



H.55 x L.60 mm  
Art. 13.185.18 base 37 Senza foro / Without hole  
Art. 13.185.19 Ø 20,5 Art. 13.185.22 Ø 27,5  
Art. 13.185.20 Ø 22,5 Art. 13.185.23 □ 14,5  
Art. 13.185.21 Ø 25,5 Art. 13.185.24 □ 16,5



H.110 x L.40 mm  
Art. 13.185.25 Ø 16,5



H.70 x L.45 mm  
Art. 13.185.26 Ø 20



H.135 mm  
Art. 13.185.27 Ø 14,5  
H.150 mm  
Art. 13.185.28 Ø 16,5



H.70 mm  
Art. 13.185.30 Ø 14,5  
H.80 mm  
Art. 13.185.31 Ø 16,5



H.55 X L.47 mm.  
Art. 13.186



H.55 X L.47 mm.  
Art. 13.187 Ø 14,5  
Art. 13.188 Ø 16,5  
Art. 13.188.01 Ø 18,5  
Art. 13.188.02 Ø 12,5  
Art. 13.189 □ 14,5  
Art. 13.190 □ 16,5  
Art. 13.190.01 □ 12,5



H.125 X L.35 mm.  
Art. 13.190.02 S.F.  
Art. 13.190.03 Ø 12,5  
Art. 13.190.04 Ø 14,5  
Art. 13.190.05 Ø 16,5  
Art. 13.190.06 Ø 18,5  
Art. 13.190.07 □ 14,5  
Art. 13.190.08 □ 16,5



H.120 X L.28 mm.  
Art. 13.191 S.F.  
Art. 13.192 Ø 14,5  
Art. 13.193 Ø 16,5  
Art. 13.193.01 Ø 12,5  
Art. 13.193.02 □ 12,5

Tutte le parti di questo catalogo - foto comprese - sono di proprietà Euro-Fer. La riproduzione, anche parziale, è vietata in ogni forma e con ogni mezzo. / Every part of this catalogue - photos included - is Euro-Fer's property. All forms of copying are strictly prohibited.



H.70 X L.35 mm.

Art. 13.194 S.F.  
Art. 13.195 Ø 16,5  
Art. 13.195.01 Ø 18,5  
Art. 13.195.02 Ø 14,5  
Art. 13.195.03 Ø 12,5  
Art. 13.195.04 □ 14,5  
Art. 13.195.05 □ 16,5



H.64 X L.33 mm.

Art. 13.196 S.F.  
Art. 13.197 Ø 14,5  
Art. 13.198 Ø 16,5  
Art. 13.198.01 Ø 12,5  
Art. 13.198.02 □ 12,5



H.50 X L.45 mm.

Art. 13.199



H.90 X L.45 mm.

Art. 13.200



H.50 X L.45 mm.

Art. 13.201 □ 14,5  
Art. 13.202 □ 16,5  
Art. 13.202.01 □ 18,5  
Art. 13.202.02 Ø 18,5  
Art. 13.202.03 Ø 20,5  
Art. 13.202.04 Ø 22,5  
Art. 13.202.05 Ø 25,5



H.90 X L.45 mm.

Art. 13.203 Ø 14  
Art. 13.204 Ø 18,5  
Art. 13.204.01 Ø 20,5  
Art. 13.204.02 Ø 22,5  
Art. 13.204.03 Ø 25,5  
Art. 13.205 □ 14,5  
Art. 13.206 □ 16,5  
Art. 13.206.01 □ 18,5



H.40 X L.40 mm.

Art. 13.207



H.68 X L.40 mm.

Art. 13.208



H.40 X L.40 mm.

Art. 13.209 □ 12,5  
Art. 13.210 □ 14,5  
Art. 13.210.01 □ 16,5  
Art. 13.210.02 Ø 16,5  
Art. 13.210.03 Ø 18,5  
Art. 13.210.04 Ø 20,5  
Art. 13.210.05 Ø 22,5



H.68 X L.40 mm.

Art. 13.211 □ 12,5  
Art. 13.212 □ 14,5  
Art. 13.213 □ 16,5  
Art. 13.213.01 Ø 16,5  
Art. 13.213.02 Ø 18,5  
Art. 13.213.03 Ø 20,5  
Art. 13.213.04 Ø 22,5



H.45 X L.40 mm.

Art. 13.213.05 □ 12,5  
Art. 13.213.06 □ 14,5



H.25 X L.40 mm.

Art. 13.213.07 □ 12,5  
Art. 13.213.08 □ 14,5



H.45 X L.40 mm.

Art. 13.213.10 Ø 14,5  
Art. 13.213.11 Ø 16,5



H.25 X L.40 mm.

Art. 13.213.12 Ø 12,5  
Art. 13.213.13 Ø 14,5  
Art. 13.213.14 Ø 16,5

## BORCHIE IN TUBO DI FERRO / TUBULAR IRON BUSHES



H.90 X L.40 mm

Art. TB.13.213.16 Ø 14,5



H.45 X L.30 mm

Art. TB.13.213.19 Ø 12,5  
Art. TB.13.213.20 Ø 14,5



H.15 X L.30 mm

Art. TB.13.213.22 Ø 14,5



H.68 X L. 30 mm

Art. TB.13.213.17 Ø 12,5  
Art. TB.13.213.18 Ø 14,5



H.20 x L. 30 mm

Art. TB.13.213.23 Ø 12,5



H.118 x L. 40 mm

Art. TB.13.213.25 Ø 14,5  
Art. TB.13.213.26 Ø 16,5



H.140 x L. 30 mm

Art. TB.13.213.30 Ø 12,5  
Art. TB.13.213.31 Ø 14,5



H.118 x L. 30 mm

Art. TB.13.213.34 Ø 12,5  
Art. TB.13.213.35 Ø 14,5



H.83 x L. 30 mm

Art. TB.13.213.38 Ø 12,5  
Art. TB.13.213.39 Ø 14,5



H.65 x L. 30 mm

Art. TB.13.213.44 Ø 12,5  
Art. TB.13.213.45 Ø 14,5



H.90 X L. base 40 mm.  
**Art. 13.214**



H.90 X L. base 40 mm.  
**Art. 13.214.01**



H.120 X L. base 55 mm.  
**Art. 13.216**

H.190 X L. base 90 mm.  
**Art. 13.216.01**

H.150 X L. base 70 mm.  
**Art. 13.216.02**

H.85 X L. base 43 mm.  
**Art. 13.216.03**

H.55 X L. base 28 mm.  
**Art. 13.216.04**



H.90 mm.  
**Art. 13.217**  
base Ø 50 mm.



H.180 mm.  
**Art. 13.218**  
base Ø 100 mm.



H. 57 X L. base 36 mm.  
**Art. 13.218.01**  
base □ 16 mm.



H.80 mm.  
**Art. 13.219**  
base 28 mm.



H.100 mm.  
**Art. 13.220**  
base 50 mm.



H.180 mm.  
**Art. 13.221**  
base 100 mm.



H.140 mm. - sfera Ø 110  
**Art. 13.221.01**  
base Ø 90 mm.

H.125 mm. - sfera Ø 90  
**Art. 13.221.02**  
base Ø 70 mm.



H.100 mm. - sfera Ø 70  
**Art. 13.221.03**  
base Ø 55 mm.

H.85 mm. - sfera Ø 55  
**Art. 13.221.04**  
base Ø 45 mm.



H.200 mm.  
**Art. 13.221.05**  
base Ø 50 mm.



H.100 mm.  
**Art. 13.222**  
base Ø 50 mm.

H.180 mm.  
**Art. 13.222.01**  
base Ø 100 mm.



**Art. 13.223**



H.90 X L.35 mm.  
**Art. 13.223.01** Ø 16,5  
**Art. 13.223.02** Ø 18,5  
**Art. 13.223.03** Ø 22,5



H.90 X L.35 mm.  
**Art. 13.223.04** □ 14,5  
**Art. 13.223.05** □ 16,5



H.135 X L.36 mm.  
**Art. 13.223.06** Senza foro/Without hole  
**Art. 13.223.07** Con foro/With hole Ø 12,5  
**Art. 13.223.08** Con foro/With hole Ø 14,5  
**Art. 13.223.09** Con foro/With hole Ø 16,5  
**Art. 13.223.10** Con foro/With hole □ 12,5



H.75 X L.36 mm.  
**Art. 13.223.11** Senza foro/Without hole  
**Art. 13.223.12** Con foro/With hole Ø 12,5  
**Art. 13.223.13** Con foro/With hole Ø 14,5  
**Art. 13.223.14** Con foro/With hole Ø 16,5  
**Art. 13.223.15** Con foro/With hole □ 12,5



H.48 X L.38 mm.  
**Art. 13.223.16** Senza foro/Without hole  
**Art. 13.223.17** Con foro/With hole Ø 12,5  
**Art. 13.223.18** Con foro/With hole Ø 14,5  
**Art. 13.223.19** Con foro/With hole Ø 16,5  
**Art. 13.223.20** Con foro/With hole □ 12,5



H.96 X L.38 mm.  
**Art. 13.223.21** Senza foro/Without hole  
**Art. 13.223.22** Con foro/With hole Ø 12,5  
**Art. 13.223.23** Con foro/With hole Ø 14,5  
**Art. 13.223.24** Con foro/With hole Ø 16,5  
**Art. 13.223.25** Con foro/With hole □ 12,5





H.40 X L.30 mm.  
Art. 13.223.26 Ø 12,5  
Art. 13.223.27 Ø 14,5  
Art. 13.223.28 □ 12,5



H.90 mm.  
Art. 13.224.01  
base Ø 40 mm.  
H.65 mm.  
Art. 13.224.02  
base Ø 27 mm.



H.70 X L.30 mm.  
Art. 13.224.03  
base □ 23 mm.



H.60 X L.43 mm.  
Art. 13.225



H.50 X L.35 mm.  
Art. 13.226



H.130 mm.  
Art. 13.227  
Ø 75 mm.



H.120 mm.  
Art. 13.228  
Ø 75 mm.



H.155 X L.60 mm.  
Art. 13.228.01  
base Ø 35 mm.



H.120 mm.  
Art. 13.229  
Ø 75 mm.



H.90 X L.50 mm.  
Art. 13.229.01  
base Ø 33 mm.



H.100 mm.  
Art. 13.230  
Ø 55 mm.



H.155 X L.50 mm.  
Art. 13.230.01  
base Ø 22 mm.



H.130 mm.  
Art. 13.231  
Ø 60 mm.



H.90 mm.  
Art. 13.232  
Ø 50 mm.



H.100 mm.  
Art. 13.233  
Ø 55 mm.



H.75 X L.30 mm.  
Art. 13.233.01



H.50 X L.30 mm.  
Art. 13.234



H.65 X L.35 mm.  
Art. 13.235



H.60 mm.  
Art. 13.235.01  
base □ 25 mm.



H.150 mm.  
Art. 13.235.04  
base □ 80 mm.



H.60 mm.  
Art. 13.235.06  
base Ø 27 mm.

H.150 mm.  
Art. 13.235.09  
base Ø 60 mm.

H.85 mm.  
Art. 13.235.02  
base □ 40 mm.

H.200 mm.  
Art. 13.235.05  
base □ 100 mm.

H.85 mm.  
Art. 13.235.07  
base Ø 42 mm.

H.200 mm.  
Art. 13.235.10  
base Ø 90 mm.

H.125 mm.  
Art. 13.235.03  
base □ 60 mm.

H.125 mm.  
Art. 13.235.08  
base Ø 48 mm.



H.150 mm. / Ø 100 mm.

Art. 13.235.11  
base □ 100 mm.

H.120 mm. / Ø 80 mm.

Art. 13.235.12  
base □ 80 mm.

H.105 mm. / Ø 70 mm.

Art. 13.235.13  
base □ 60 mm.

H.75 mm. / Ø 50 mm.

Art. 13.235.14  
base □ 40 mm.

H.45 mm. / Ø 30 mm.

Art. 13.235.15  
base □ 25 mm.



H.45 mm.  
Art. 13.236  
Ø 30 mm.

H.65 mm.  
Art. 13.237  
Ø 50 mm.

H.70 mm.  
Art. 13.238  
Ø 55 mm.

H.80 mm.  
Art. 13.239  
Ø 65 mm.



*Sfere Lisce / Smooth Spheres*

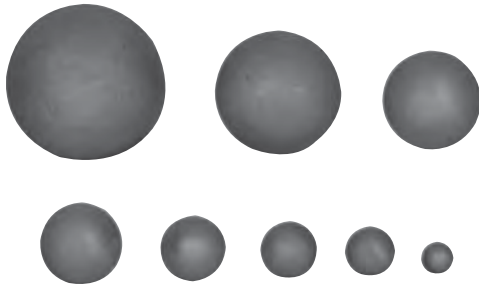

- Art. 13.240 Ø 15 mm.
- Art. 13.241 Ø 20 mm.
- Art. 13.242 Ø 25 mm.
- Art. 13.243 Ø 30 mm.
- Art. 13.244 Ø 35 mm.
- Art. 13.245 Ø 40 mm.
- Art. 13.246 Ø 50 mm.
- Art. 13.247 Ø 60 mm.
- Art. 13.248 Ø 70 mm.
- Art. 13.249 Ø 80 mm.
- Art. 13.250 Ø 90 mm.
- Art. 13.251 Ø 100 mm.
- Art. 13.251.01 Ø 120 mm.

*Sfere Vuote in lamiera / Hollow Spheres in Iron Sheet*

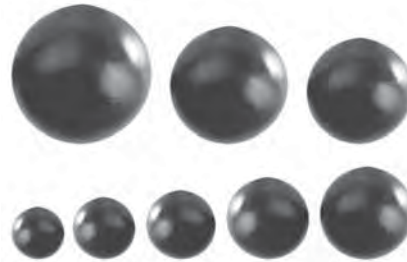

- Art. 13.251.30 Ø 30 mm.
- Art. 13.251.35 Ø 35 mm.
- Art. 13.251.40 Ø 40 mm.
- Art. 13.251.50 Ø 50 mm.
- Art. 13.251.60 Ø 60 mm.
- Art. 13.251.70 Ø 70 mm.
- Art. 13.251.80 Ø 80 mm.
- Art. 13.251.90 Ø 90 mm.
- Art. 13.251.100 Ø 100 mm.
- Art. 13.251.120 Ø 120 mm.
- Art. 13.251.150 Ø 150 mm.
- Art. 13.251.200 Ø 200 mm.

Si raccomanda di zincare a caldo le sfere vuote in lamiera solo dopo averle forate  
It's recommended to perforate the Hollow Spheres before the hot galvanization

*Sfere Schiacciate / Crushed Spheres*

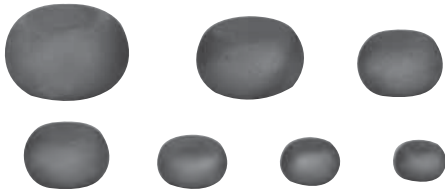

- H.50 X L.80 mm.  
Art. 13.252
- H.40 X L.70 mm.  
Art. 13.253
- H.35 X L.55 mm.  
Art. 13.254
- H.28 X L.45 mm.  
Art. 13.255
- H.26 X L.40 mm.  
Art. 13.256
- H.22 X L.35 mm.  
Art. 13.257

*Sfere Forgiate Diamantate / Diamond Forged Spheres*



- Art. 13.252.20 Ø 20 mm.
- Art. 13.252.25 Ø 25 mm.
- Art. 13.252.30 Ø 30 mm.
- Art. 13.252.35 Ø 35 mm.
- Art. 13.252.40 Ø 40 mm.
- Art. 13.252.50 Ø 50 mm.
- Art. 13.252.60 Ø 60 mm.
- Art. 13.252.70 Ø 70 mm.
- Art. 13.252.80 Ø 80 mm.
- Art. 13.252.90 Ø 90 mm.
- Art. 13.252.100 Ø 100 mm.
- Art. 13.252.120 Ø 120 mm.
- Art. 13.252.150 Ø 150 mm.

*Sfere Forgiate / Forged Spheres*

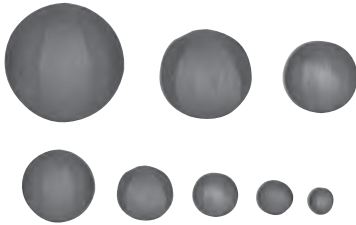

- Art. 13.258 Ø 20 mm.
- Art. 13.259 Ø 25 mm.
- Art. 13.260 Ø 30 mm.
- Art. 13.261 Ø 35 mm.
- Art. 13.262 Ø 40 mm.
- Art. 13.263 Ø 50 mm.
- Art. 13.264 Ø 60 mm.
- Art. 13.265 Ø 70 mm.
- Art. 13.266 Ø 80 mm.
- Art. 13.267 Ø 90 mm.
- Art. 13.268 Ø 100 mm.

*Mezze sfere vuote in lamiera / Half hollow spheres in iron sheet*



- Spessore / Thickness 3 mm
- Art. 13.251.40H Ø 40 mm
  - Art. 13.251.50H Ø 50 mm
  - Art. 13.251.60H Ø 60 mm
  - Art. 13.251.70H Ø 70 mm
  - Art. 13.251.80H Ø 80 mm
  - Art. 13.251.90H Ø 90 mm
  - Art. 13.251.100H Ø 100 mm
  - Art. 13.251.120H Ø 120 mm
  - Art. 13.251.150H Ø 150 mm
  - Art. 13.251.200H Ø 200 mm.

*Sfere Piene Forate / Holed Solid Spheres*

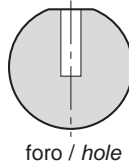

foro / hole

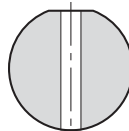

foro passante  
passing hole

foro passante / passing hole



Ø 25 mm.

- Art. 13.242.F12  
foro / hole Ø 12,5 mm.
- Art. 13.242.F12H  
foro passante / passing hole Ø 12,5 mm.
- Art. 13.243.F12  
foro / hole Ø 12,5 mm.
- Art. 13.243.F12H  
foro passante / passing hole Ø 12,5 mm.



Ø 35 mm.

- Art. 13.244.F12  
foro / hole Ø 12,5 mm.
- Art. 13.244.F12H  
foro passante / passing hole Ø 12,5 mm.
- Art. 13.244.F14  
foro / hole Ø 14,5 mm.
- Art. 13.244.F14H  
foro passante / passing hole Ø 14,5 mm.

- Art. 13.244.F16  
foro / hole Ø 16,5 mm.
- Art. 13.244.F16H  
foro passante / passing hole Ø 16,5 mm.

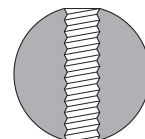
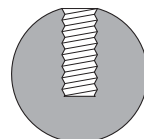

*Sfere Piene Forate e Filettate / Solid Spheres with Threaded Hole*

- Art. 13.268.50 Ø 12 mm. Filetto / Threaded M6 cieco
- Art. 13.268.51 Ø 12 mm. Filetto / Threaded M6 passante / passing
- Art. 13.268.60 Ø 16 mm. Filetto / Threaded M8 cieco
- Art. 13.268.61 Ø 16 mm. Filetto / Threaded M8 passante / passing
- Art. 13.268.65 Ø 20 mm. Filetto / Threaded M10 cieco
- Art. 13.268.66 Ø 20 mm. Filetto / Threaded M10 passante / passing



**Pomoli in Ottone / Brass Knobs**

H.55 X L.42 mm.  
**Art. 13.271**  
base 30 mm.  
Filettato MA 10  
Threaded MA 10



Art. 13.272



Art. 13.273



H.100 X L.60 mm  
**Art. 13.273.01**  
foro Ø 25,5 mm  
base 30 mm  
Filettato MA 10  
Threaded MA 10

**Pomoli in cristallo /  
Crystal Knobs**

Fissaggio con granello / Fastening with dowel



H.100 X L.65 mm.  
**Art. 13.273.05**  
Ø foro 35,5 mm.  
base 50 mm.



H.40 X L.25 mm.  
**Art. 13.273.09**  
base 18 mm.

Filettato MA 4  
With Threaded MA 4





H.60 mm.  
Art. 13.274 Ø 12,5 mm. L.30  
Art. 13.275 Ø 14,5 mm. L.32  
Art. 13.276 Ø 16,5 mm. L.33  
Art. 13.277 Ø 18,5 mm. L.35



H.60 mm.  
Art. 13.278 Ø 12,5 mm. L.29  
Art. 13.279 Ø 14,5 mm. L.31  
Art. 13.280 Ø 16,5 mm. L.33  
Art. 13.281 Ø 18,5 mm. L.36



H.40 X L.25 mm.  
Art. 13.282 Ø 12,5 mm.  
Art. 13.283 Ø 14,5 mm.  
Art. 13.284 Ø 16,5 mm.  
Art. 13.285 Ø 18,5 mm.



H.26 mm.  
Art. 13.286 Ø 12,5 mm. L.30  
Art. 13.287 Ø 14,5 mm. L.32



H.26 mm.  
Art. 13.290 Ø 12,5 mm. L.29  
Art. 13.291 Ø 14,5 mm. L.31

*Fissaggio con granello / Fastening with dowel*



H.26 X L.30 mm.  
Art. 13.293.01  
Ø foro 12,5 mm.  
H.26 X L.32 mm.  
Art. 13.293.02  
Ø foro 14,5 mm.  
H.26 X L.33 mm.  
Art. 13.293.03  
Ø foro 16,5 mm.  
H.26 X L.35 mm.  
Art. 13.293.04  
Ø foro 18,5 mm.



H.60 X L.32 mm.  
Art. 13.293.06  
Ø foro 14,5 mm.  
H.60 X L.33 mm.  
Art. 13.293.07  
Ø foro 16,5 mm.



H.26 X L.29 mm.  
Art. 13.293.09  
Ø foro 12,5 mm.  
H.26 X L.33 mm.  
Art. 13.293.10  
Ø foro 14,5 mm.  
H.26 X L.33 mm.  
Art. 13.293.11  
Ø foro 16,5 mm.  
H.26 X L.36 mm.  
Art. 13.293.12  
Ø foro 18,5 mm.



H.60 X L.29 mm.  
Art. 13.293.13  
Ø foro 12,5 mm.  
H.60 X L.33 mm.  
Art. 13.293.15  
Ø foro 16,5 mm.  
H.60 X L.36 mm.  
Art. 13.293.16  
Ø foro 18,5 mm.



H.25 X L.35 mm.  
Art. 13.294 Ø 14,5 mm.  
Art. 13.295 Ø 12,5 mm.



H.83 X L.35 mm.  
Art. 13.296  
Ø foro 12,5 mm.  
H.83 X L.35 mm.  
Art. 13.296.01  
Ø foro 14,5 mm.

Fissaggio con granello  
Fastening with dowel



H.90 X L.20 mm.  
Art. 13.297  
Ø foro 12,5 mm.  
Fissaggio con granello  
Fastening with dowel

*Fissaggio con granello / Fastening with dowel*



H.42 X L.50 mm.  
Art. 13.297.02  
Ø foro 30,5 mm.  
Fissaggio con granello  
Fastening with dowel



H.55 X L.50 mm.  
Art. 13.297.03  
Ø foro 20,5 mm.  
H.55 X L.50 mm.  
Art. 13.297.04  
Ø foro 25,5 mm.

Fissaggio con granello  
Fastening with dowel



H.119 X L.48 mm.  
Art. 13.297.05  
Ø foro 30,5 mm.  
Fissaggio con granello  
Fastening with dowel



H.120 X L.65 mm.  
Art. 13.297.06  
Ø foro 25,5 mm.  
H.120 X L.65 mm.  
Art. 13.297.07  
Ø foro 30,5 mm.

Fissaggio con granello  
Fastening with dowel



H.260 X L.50 mm.  
Art. 13.297.09  
Ø foro 25,5 mm.  
Fissaggio con granello  
Fastening with dowel



H.55 X L.63 mm.  
Art. 13.297.10  
Ø foro 25,5 mm.  
H.60 X L.73 mm.  
Art. 13.297.11  
Ø foro 30,5 mm.  
H.60 X L.73 mm.  
Art. 13.297.12  
Ø foro 35,5 mm.

*Fissaggio con granello / Fastening with dowel*



H.20 X Base 80 X 80 mm.  
Art. 13.297.15  
□ foro 25,5 mm.



H.13 X Base 24 X 24 mm.  
Art. 13.297.17  
□ foro 14,5 mm.



H.15 X Base 30 X 30 mm.  
Art. 13.297.18  
□ foro 20,5 mm.

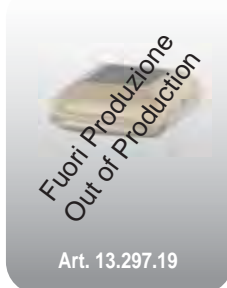

Art. 13.297.19



H.50 X L.33 mm.  
Art. 13.298 Ø 22 mm  
H.50 X L.37 mm.  
Art. 13.299 Ø 30 mm

**BORCHIE, LANCE E PIASTRE  
STUDS, SPEARS AND PLATES**

H.110 X L.110 mm. - sp.10 mm.  
**Art. 13.300** □ foro 26 mm.  
**Art. 13.301** □ foro 31 mm.

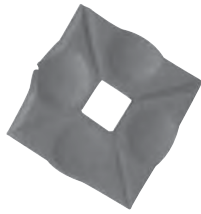

H.70 X L.70 mm. - sp.8 mm.  
**Art. 13.304** □ foro 16,5 mm.  
**Art. 13.305** □ foro 21 mm.

H.50 X L.50 mm. - sp. 6 mm.  
**Art. 13.306** □ foro 12,5 mm.  
**Art. 13.306.01** □ foro 14,5 mm.  
**Art. 13.307** □ foro 16,5 mm.

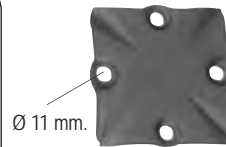

H.100 X L.100 mm.  
**Art. 13.308**  
 Spessore 10 mm.



H.100 X L.100 mm.  
**Art. 13.309**  
 Spessore 10 mm.

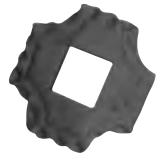

H.70 X L.70 mm. - sp.4 mm.  
**Art. 13.310** □ Foro 24 mm.

NEW



H.80 X L.80 mm.  
**Art. 13.310.10**  
 Spessore 8 mm.

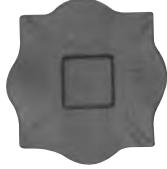

H.100 X L.100 mm.  
**Art. 13.311**  
 Spessore 10 mm.



H.100 X L.100 mm. - sp.10 mm.  
**Art. 13.312** □ Foro 25 mm.  
**Art. 13.313** □ Foro 30 mm.



H.22 mm.  
**Art. 13.313.01**  
 Base 120 mm.



H.22 X Base 120 mm.  
**Art. 13.313.02** Ø Foro 50,5 mm.  
**Art. 13.313.03** Ø Foro 65,5 mm.  
**Art. 13.313.04** Ø Foro 80,5 mm.



H.20 mm.  
**Art. 13.314** Base 80 mm.  
**Art. 13.315** Base 60 mm.  
**Art. 13.316** Base 50 mm.  
**Art. 13.317** Base 40 mm.  
**Art. 13.318** B. 30 X 35 mm.



Base 80 X 80 H.20 mm.  
**Art. 13.319** □ Foro 30,5 mm.  
**Art. 13.320** □ Foro 35,5 mm.  
**Art. 13.321** □ Foro 40,5 mm.

Base 60 X 60 H.20 mm.  
**Art. 13.322** □ Foro 25,5 mm.  
**Art. 13.323** □ Foro 30,5 mm.

Base 50 X 50 H.20 mm.  
**Art. 13.324** □ Foro 16,5 mm.  
**Art. 13.325** □ Foro 18,5 mm.  
**Art. 13.326** □ Foro 20,5 mm.

Base 40 X 40 H.20 mm.  
**Art. 13.327** □ Foro 12,5 mm.  
**Art. 13.328** □ Foro 14,5 mm.  
**Art. 13.329** □ Foro 16,5 mm.

Base 36 X 30 H.20 mm.  
**Art. 13.330** □ Foro 12,5 mm.  
**Art. 13.331** □ Foro 14,5 mm.  
**Art. 13.332** □ Foro 12X15 mm.

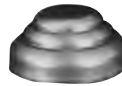

**Art. 13.333**  
 Base Ø 80 mm.

**Art. 13.334**  
 Base Ø 60 mm.

**Art. 13.335**  
 Base Ø 50 mm.

**Art. 13.336**  
 Base Ø 40 mm.

**Art. 13.337**  
 Base Ø 30 mm.

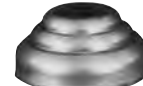

Base Ø 80 mm.  
**Art. 13.338** Ø Foro 30,5 mm.  
**Art. 13.339** Ø Foro 35,5 mm.  
**Art. 13.340** Ø Foro 40,5 mm.

Base Ø 60 mm.  
**Art. 13.341** Ø Foro 25,5 mm.  
**Art. 13.342** Ø Foro 30,5 mm.

Base Ø 50 mm.  
**Art. 13.343** Ø Foro 16,5 mm.  
**Art. 13.344** Ø Foro 18,5 mm.  
**Art. 13.345** Ø Foro 20,5 mm.

Base Ø 40 mm.  
**Art. 13.346** Ø Foro 12,5 mm.  
**Art. 13.347** Ø Foro 14,5 mm.  
**Art. 13.348** Ø Foro 16,5 mm.

Base Ø 30 mm.  
**Art. 13.349** Ø Foro 12,5 mm.  
**Art. 13.350** Foro ovale 12,5 mm.

H. 20 mm.



H.1000 □ 16 mm.  
**Art. 13.350.01**  
 H.1000 □ 20 mm.  
**Art. 13.350.02**

**Elementi in Ottone / Brass Studs**



H.250 mm. □ 14 mm.  
**Art. 13.350.03**  
 H.250 mm. □ 16 mm.  
**Art. 13.350.04**



H.250 mm. □ 16 mm.  
**Art. 13.350.05**  
 H.250 mm. □ 20 mm.  
**Art. 13.350.06**



H. 110 X L. 55 mm.  
**Art. 13.351**  
 Base Ø 34 mm.  
 (filettato MA 8)

H. 120 X L. 60 mm.  
**Art. 13.352**  
 Base Ø 40 mm.  
 (filettato MA 10)



H. 63 X L. 42 mm.  
**Art. 13.353**  
 Base Ø 30 mm.  
 (filettato MA 8)



H. 70 X L. 40 mm.  
**Art. 13.356**  
 Base Ø 25 mm.  
 (filettato MA 8)

H. 95 X L. 45 mm.  
**Art. 13.357**  
 Base Ø 38 mm.  
 (filettato MA 10)

H. 110 X L. 55 mm.  
**Art. 13.358**  
 Base Ø 40 mm.  
 (filettato MA 10)

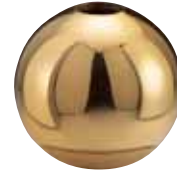

**Art. 13.359**  
 Sfera Ø 35 mm.  
 Foro Ø 14 mm.

**Art. 13.360**  
 Sfera Ø 45 mm.  
 Foro Ø 14 mm.

**Art. 13.361**  
 Sfera Ø 55 mm.  
 Foro Ø 14 mm.



**Art. 13.362**  
 Sfera Ø 45 mm.  
 Foro □14 mm.

**Art. 13.363**  
 Sfera Ø 55 mm.  
 Foro □14 mm.

Fissaggio con granello  
 Fastening with dowel  
 Foro passante  
 Passing hole

Fissaggio con granello / Fastening with dowel



Sfera vuota filettata internamente  
*Internally-threaded empty sphere*

H.46 mm. MA 10  
**Art. 13.386** Ø 45 mm.  
H.72 mm. MA 10  
**Art. 13.389** Ø 75 mm.  
H.83 mm. MA 10  
**Art. 13.390** Ø 85 mm.  
H.120 mm. MA 10  
**Art. 13.392** Ø 120 mm.



H.45 X L.40 mm.  
**Art. 13.393**  
Foro Ø16 mm.



H.45 X L.40 mm.  
**Art. 13.394**  
Foro Ø16 mm.



H.105 X L.40 mm.  
**Art. 13.400** Foro Ø 12,5mm.  
**Art. 13.400.01** Foro Ø 14,5mm.  
**Art. 13.400.02** Foro Ø 16,5mm.



H.75 X L.40 mm.  
**Art. 13.401** Foro Ø 12,5mm.  
**Art. 13.401.01** Foro Ø 14,5mm.  
**Art. 13.401.02** Foro Ø 16,5mm.



H.30 X L.40 mm.  
**Art. 13.402** Foro Ø 12,5mm.  
**Art. 13.402.01** Foro Ø 14,5mm.  
**Art. 13.402.02** Foro Ø 16,5mm.

Borchie in ottone / Brass studs  
Fissaggio con granello / Fastening with dowel

Distanziali regolabili / Adjustable support



Ferro zincato / Iron  
H.23 - 33 mm  
**Art. 13.510** Ø 30 - foro10,5  
H.23 - 33 mm  
**Art. 13.511** Ø 35 - foro14,5



Ferro zincato / Iron  
H.30 - 40 mm  
**Art. 13.514** Ø 30 - foro14,5  
H.30 - 40 mm  
**Art. 13.515** Ø 35 - foro14,5



Ferro zincato / Iron  
H.32 - 42 mm  
**Art. 13.518** Ø 30 - foro10,5  
H.32 - 42 mm  
**Art. 13.519** Ø 35 - foro14,5



Ferro zincato / Iron  
H.45 - 65 mm  
**Art. 13.522** Ø 30 - foro14,5  
H.45 - 65 mm  
**Art. 13.523** Ø 35 - foro14,5





Spessore 5 mm.  
Art. 14.001 Ø 95 mm.



Spessore 4 mm.  
Art. 14.002 Ø 95 mm.



Spessore 5 mm.  
Art. 14.003 Ø 95 mm.



Spessore 3 mm.  
Art. 14.003.01 Ø 68 mm.  
Art. 14.003.02 Ø 97 mm.  
Art. 14.003.03 Ø 120 mm.

NEW



Spessore 2 mm.  
Art. 14.003.04 Ø 95 mm.



Spessore 4 mm.  
Art. 14.004 Ø 63 mm.



Spessore 5 mm.  
Art. 14.005 Ø 93 mm.



Spessore 0,8 mm.  
Art. 14.005.01 Ø 77 mm.  
Art. 14.005.02 Ø 111 mm.



H. 10 Spessore 0,8 mm  
Art. 14.005.03 Ø 85 mm.  
Foro Ø 10 mm.



H. 35 Spessore 2 mm  
Art. 14.005.04 Ø 135 mm.  
Foro Ø 11 mm.



H. 17 Spessore 0,5 mm  
Art. 14.005.05 Ø 80 mm.  
Foro Ø 10 mm.



Spessore 3 mm.  
Art. 14.005.06 Ø 60 mm.  
Foro Ø 10 mm.



Spessore 3 mm.  
Art. 14.005.07 Ø 90 mm.  
Foro Ø 10 mm.



H.21 - Spessore 1 mm.  
Art. 14.005.08 Ø 105 mm.  
Foro Ø 10 mm.



H.10 - Spessore 10 mm.  
Art. 14.005.09 Ø 65 mm.  
Foro Ø 12,5 mm.



Spessore 3 mm.  
Art. 14.006 Ø 65 mm.



Spessore 3 mm  
Art. 14.007 Ø 92 mm.



Spessore 3 mm.  
Art. 14.008 Ø 118 mm.



Spessore 3 mm  
Art. 14.010 Ø 98 mm.



Spessore 3 mm  
Art. 14.011 Ø 122 mm.

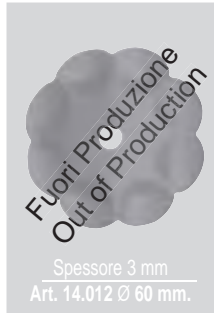

Spessore 3 mm  
Art. 14.012 Ø 60 mm.

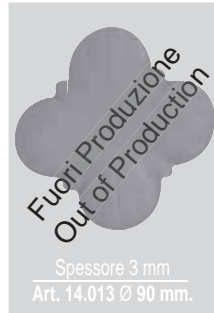

Spessore 3 mm  
Art. 14.013 Ø 90 mm.



Spessore 3 mm.  
Art. 14.014 Ø 60 mm.



Spessore 3 mm.  
Art. 14.014.01 Ø 62 mm.

NEW



Spessore/Thickness 2,5 mm.  
Art. 14.014.02 Ø 60

NEW



Spessore/Thickness 2,5 mm.  
Art. 14.014.03 Ø 95

NEW



Spessore/Thickness 2,5 mm.  
Art. 14.014.04 Ø 95



Spessore 3 mm.  
Art. 14.015 Ø 95 mm.  
Art. 14.015.01 Ø 120 mm.



Spessore 2 mm.  
Art. 14.016 Ø 60 mm.

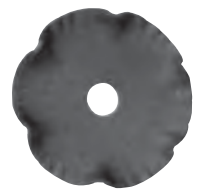

Spessore 2 mm.  
Art. 14.017 Ø 60 mm.



Spessore 1 mm.  
Art. 14.018 Ø 37 mm.

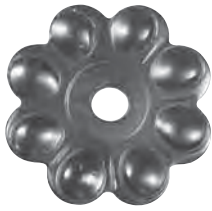

Spessore 5 mm.  
Art. 14.018.01 Ø 60 mm.  
Foro Ø 10 mm.

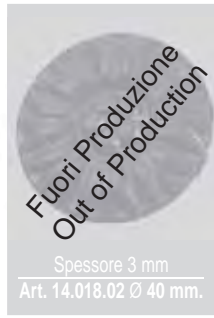

Spessore 3 mm  
Art. 14.018.02 Ø 40 mm.



Spessore 2 mm.  
Art. 14.019 Ø 60 mm.



Spessore 3 mm  
Art. 14.019.01 Ø 65 mm.



Spessore 3 mm  
Art. 14.019.02 Ø 60 mm.



Spessore 7 mm.  
Art. 14.020 Ø 68 mm.



Spessore 2 mm.  
Art. 14.021 Ø 90 mm.



Spessore 2 mm.  
Art. 14.021.01 Ø 135 mm.  
Foro Ø 10 mm.



Spessore 2 mm.  
Art. 14.022 Ø 85 mm.



Spessore 2 mm.  
Art. 14.023 Ø 85 mm.

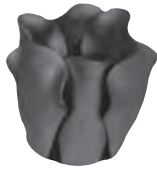

H.40 - Spessore 0,5 mm.  
Art. 14.024 Ø 40 mm.

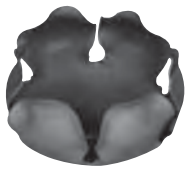

H.35 - Spessore 0,5 mm.  
Art. 14.025 Ø 55 mm.



H.30 - Spessore 0,5 mm.  
Art. 14.026 Ø 65 mm.

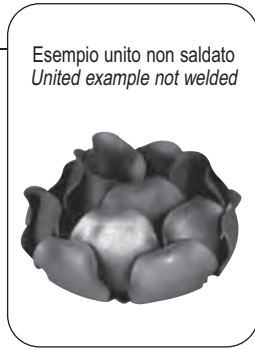

Esempio unito non saldato  
United example not welded



H.50 mm. - Spessore 2 mm.  
Art. 14.026.01 Ø 75 mm.  
Foro Ø 10 mm.



H.70 mm. - Spessore 0,6 mm.  
Art. 14.027 Ø 90 mm.



Spessore 3 mm  
Art. 14.027.02 Ø 60 mm.



Spessore 2 mm  
Art. 14.027.03 Ø 68 mm



Spessore 2 mm  
Art. 14.027.04 Ø 95 mm



H. 42 - Spessore 0,6 mm.  
Art. 14.030 Ø 40 mm.



Spessore 3 mm  
Art. 14.032.01 Ø 130 mm.



Spessore 0,6 mm.  
Art. 14.034 Ø 65 mm.



Spessore 1 mm.  
Art. 14.034.01 Ø 70 mm.

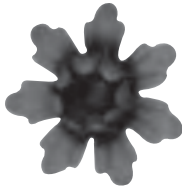

Spessore 0,5 mm.  
Art. 14.035 Ø 42 mm.



Spessore 3 mm.  
Art. 14.035.01 Ø 110 mm.



H 45 mm-Spessore 1,5 mm.  
Art. 14.035.02 Ø 35 mm.



H 47 mm-Spessore 1,5 mm.  
Art. 14.035.03 Ø 60 mm.



H 135 X L.80 mm  
Art. 14.035.04



FIORI E FOGLIE  
FLOWERS AND LEAVES



H 325 mm  
Art. 14.035.05 Ø 6 mm.



H 325 mm  
Art. 14.035.06 Ø 6 mm.



H 325 mm  
Art. 14.035.07 Ø 6 mm.



H 325 mm  
Art. 14.035.08 Ø 6 mm.



H 180 mm  
Art. 14.035.09 Ø 3 mm.

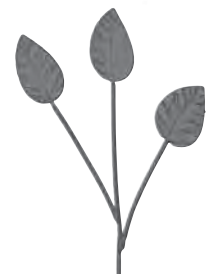

H 180 X L.130 mm  
Art. 14.035.10 Ø 3 mm.

NEW



H. 200 X L. 200 mm  
Spessore/Thickness 4 mm.  
Art. 14.035.11 Ø 200

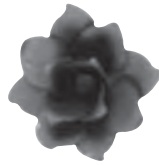

Spessore 0,5 mm.  
Art. 14.036 Ø 48 mm.



Spessore 1 mm.  
Art. 14.036.01 Ø 70 mm.



H. 45 X L.25 mm.  
Art. 14.036.02  
Spessore 0,5 mm.



H. 45 X L.30 mm.  
Art. 14.036.03  
Spessore 1,5 mm.



H. 70 X L.30 mm.  
Art. 14.036.04  
Spessore 0,5 mm.



H. 65 X L.55 mm.  
Art. 14.036.05  
Spessore 0,5 mm.



H. 115 X L.65 mm.  
Art. 14.036.06  
Spessore 0,5 mm.



H. 60 X L.50 mm.  
Art. 14.036.07  
Spessore 0,5 mm.



H. 55 X L.70 mm.  
Art. 14.036.08  
Spessore 1 mm.



H. 85 X L.45 mm.  
Art. 14.037  
Spessore 0,5 mm.



H. 83 X L.44 mm.  
Art. 14.037.01  
Spessore 1 mm.



H. 55 X L.31 mm.  
Art. 14.037.02  
Spessore 1 mm.



H. 70 X L.35 mm.  
Art. 14.038  
Spessore 0,5 mm.



H. 82 X L.47 mm.  
Art. 14.038.01  
Spessore 1 mm.



H. 195 X L.80 mm.  
Art. 14.039  
Spessore 0,5 mm.



H. 70 X L.78 mm.  
Art. 14.039.01  
Spessore 3 mm



H. 108 X L.120 mm.  
Art. 14.039.02  
Spessore 3 mm



H. 145 X L.160 mm.  
Art. 14.039.03  
Spessore 3 mm.



H. 57 X L.55 mm.  
Art. 14.040  
Spessore 0,6 mm.



H. 75 X L.70 mm.  
Art. 14.041  
Spessore 0,6 mm.



H. 105 X L.95 mm.  
Art. 14.042  
Spessore 1 mm.



H. 200 X L.190 mm.  
Art. 14.043  
Spessore 1 mm.



H. 130 X L.65 mm.  
Art. 14.044  
Spessore 1 mm.



H. 90 X L.45 mm.  
Art. 14.045  
Spessore 1 mm.



H. 240 X L. 70 mm.  
Art. 14.046  
Spessore 0,5 mm.



Tutte le parti di questo catalogo - foto comprese - sono di proprietà Euro-Fer. La riproduzione, anche parziale, è vietata in ogni forma e con ogni mezzo. / Every part of this catalogue - photos included - is Euro-Fer's property. All forms of copying are strictly prohibited.





H.175 mm.  
**Art. 14.046.01**  
Base 22 X 19 mm.



H. 170 X L.40 mm.  
**Art. 14.047**  
Spessore 0,5 mm.



H. 120 X L.40 mm.  
**Art. 14.048**  
Spessore 0,5 mm.



H. 294 X L.48 mm.  
**Art. 14.048.01**  
Spessore 1 mm.



H. 294 X L. 48 mm.  
**Art. 14.048.02**  
Spessore 1 mm.



H. 163 X L.30 mm.  
**Art. 14.048.03**  
Spessore 1 mm.



H. 60 X L.110 mm.  
**Art. 14.049**  
Spessore 1 mm.



H. 125 X L.175 mm.  
**Art. 14.050**  
Spessore 1 mm.



H.158 X L.80 mm.  
**Art. 14.050.01**  
Spessore 1 mm.



H.155X L.80 mm.  
**Art. 14.050.02**  
Spessore 1 mm.



H.27 - Spessore 1 mm.  
**Art. 14.050.03** Ø 150 mm.  
Foro Ø 10,5 mm.



H.45 - Spessore 1 mm.  
**Art. 14.050.04** Ø 120 mm.  
Foro Ø 12,5 mm.



H.200 X L.95 mm.  
**Art. 14.050.05**  
Spessore 1 mm.



H.230 X L.100 mm.  
**Art. 14.050.06**  
Spessore 1 mm.



H. 220 X L.140 mm.  
**Art. 14.051**

H. 220 X L.140 mm.  
**Art. 14.052**



H. 190 X L.140 mm.  
**Art. 14.053**



H. 190 X L.140 mm.  
**Art. 14.054**



H. 180 X L.130 mm.  
**Art. 14.055**



H. 180 X L.130 mm.  
**Art. 14.056**



H. 170 X L. 140 mm  
**Art. 14.057**



H. 170 X L.140 mm.  
**Art. 14.058**



H. 155 X L.60 mm.  
**Art. 14.059**  
H. 180 X L.65 mm.  
**Art. 14.059.01**



H. 155 X L.60 mm.  
**Art. 14.060**  
H. 180 X L.65 mm.  
**Art. 14.060.01**



H. 110 X L.40 mm.  
**Art. 14.061**



H. 110 X L.40 mm.  
**Art. 14.062**



H. 170 X L.140 mm.  
**Art. 14.057**



H. 90 X L.30 mm.  
**Art. 14.063**

H. 90 X L.30 mm.  
**Art. 14.064**



H. 125 X L.75 mm.  
**Art. 14.065**



H. 125 X L.75 mm.  
**Art. 14.066**



H. 110 X L.105 mm.  
**Art. 14.067**



H. 110 X L.105 mm.  
**Art. 14.068**



H. 80 X L.60 mm.  
**Art. 14.069**



H. 80 X L.60 mm.  
**Art. 14.070**



H. 75 X L.80 mm.  
**Art. 14.071**

H. 75 X L.80 mm.  
**Art. 14.072**



H. 55 X L.70 mm.  
**Art. 14.073**



H. 55 X L.70 mm.  
**Art. 14.074**



H. 300 X L. 70 mm.  
Art. 14.078.01  
Spessore 4 mm.



H. 185 X L. 90 mm.  
Art. 14.078.02  
Spessore 10 mm.

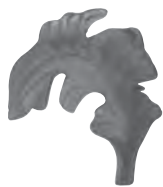

H. 90 X L. 75 mm.  
Art. 14.075

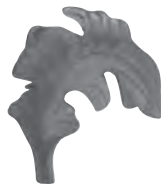

H. 90 X L. 75 mm.  
Art. 14.076



H. 110 X L. 75 mm.  
Art. 14.077



H. 215 X L. 110 mm.  
Art. 14.079  
Spessore 3 mm.



H. 205 X L. 100 mm.  
Art. 14.080  
Spessore 3 mm.



H. 165 X L. 70 mm.  
Art. 14.081  
Spessore 3 mm.



H. 125 X L. 82 mm.  
Art. 14.082  
Spessore 3 mm.



H. 140 X L. 85 mm.  
Art. 14.083  
Spessore 3 mm.



Base Ø 76 mm.  
Art. 14.083.01  
Spessore 20 mm.



Base Ø 90 mm.  
Art. 14.083.02  
Spessore 8 mm.  
Base Ø 55 mm.  
Art. 14.083.03  
Spessore 8 mm.



H. 18 X L. 35 mm.  
Art. 14.083.04



Base Ø 125 mm.  
Art. 14.083.05  
Spessore 15 mm.  
Base Ø 90 mm.  
Art. 14.083.06  
Spessore 12 mm.  
Base Ø 55 mm.  
Art. 14.083.07  
Spessore 8 mm.



H. 185 X L. 100 mm.  
Art. 14.084  
Spessore 10 mm.



H. 80 X L. 70 mm.  
Art. 14.084.01  
Spessore 3 mm.



H. 135 X L. 85 mm.  
Art. 14.084.03 / Dx  
Art. 14.084.05 / Sx  
Spessore 3 mm.



H. 130 X L. 75 mm.  
Art. 14.087  
Spessore 5 mm.



Foglie Forgiate  
Forged Leaves

H. 260 X L. 45 mm.  
Art. 14.087.01  
Spessore 5 mm. circa



Foglie Forgiate  
Forged Leaves

H. 400 X L. 60 mm.  
Art. 14.087.02  
Spessore 8 mm. circa



Foglie Forgiate  
Forged Leaves

H. 420 X L. 90 mm.  
Art. 14.087.03  
Spessore 8 mm. circa



Foglie Forgiate  
Forged Leaves

H. 270 X L. 60 mm.  
Art. 14.087.04  
Spessore 8 mm. circa



H. 115 X L. 100 mm.  
Art. 14.084.04 / Dx  
Art. 14.084.06 / Sx  
Spessore 3 mm.



H. 97 X L. 55 mm.  
Art. 14.087.05  
Spessore 4 mm



H. 90 X L. 55 mm.  
Art. 14.087.06  
Spessore 4 mm



H. 240 X L. 77 mm.  
Art. 14.087.07  
Spessore 4 mm



H. 225 X L. 60 mm.  
Art. 14.087.08  
Spessore 4 mm.



H. 190 X L. 45 mm.  
Art. 14.087.09  
Spessore 4 mm.



H.215 X L.150 mm.  
Art. 14.087.10  
Spessore 6 mm.



H.215 X L.150 mm.  
Art. 14.087.11  
Spessore 6 mm.



H.330 X L.260 mm.  
Art. 14.087.12  
Spessore 6 mm.



H.75 X L.125 mm.  
Art. 14.087.13  
Spessore 5 mm.



H.270 X L.150 mm.  
Art. 14.087.14



H.250 X L.80 mm.  
Art. 14.087.15

Decorazioni in Acciaio e Ottone / Brass and Steel Decorations

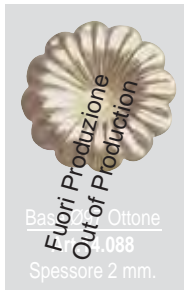

Base Ø 97 Ottone  
Art. 14.088  
Spessore 2 mm.



Base Ø 97 Acciaio  
Art. 14.089  
Spessore 1,5 mm.



H.80 X L.70 mm.  
Art. 14.090  
Ottone-Spessore 2 mm.



H.80 X L.70 mm.  
Art. 14.091  
Acciaio-Spessore 1,5 mm.



H.115 X L.100 mm.  
Art. 14.092 Ottone-Sp. 2 mm./dx  
Art. 14.092.01 Ottone-Sp. 2 mm./sx  
Art. 14.093 Acciaio-Sp. 1,5 mm./dx  
Art. 14.093.01 Acciaio-Sp. 1,5 mm./sx



H.135 X L.85 mm.  
Art. 14.094 Ottone-Sp. 2 mm./dx  
Art. 14.094.01 Ottone-Sp. 2 mm./sx  
Art. 14.095 Acciaio-Sp. 1,5 mm./dx  
Art. 14.095.01 Acciaio-Sp. 1,5 mm./sx



Base Ø 100 mm.  
Art. 14.097 Acciaio-Sp. 1,5 mm.



H.90 X L.30 mm.  
Art. 14.098 Ottone-Sp. 2 mm./dx  
Art. 14.098.01 Ottone-Sp. 2 mm./sx  
Art. 14.099 Acciaio-Sp. 1,5 mm./dx  
Art. 14.099.01 Acciaio-Sp. 1,5 mm./sx



H.115X L.50 mm.  
Art. 14.100 Ottone-Sp. 2 mm./dx  
Art. 14.100.01 Ottone-Sp. 2 mm./sx  
Art. 14.101 Acciaio-Sp. 1,5 mm./dx  
Art. 14.101.01 Acciaio-Sp. 1,5 mm./sx



H.75X L.65 mm.  
Art. 14.102 Ottone-Sp. 2 mm./dx  
Art. 14.102.01 Ottone-Sp. 2 mm./sx  
Art. 14.103 Acciaio-Sp. 1,5 mm./dx  
Art. 14.103.01 Acciaio-Sp. 1,5 mm./sx



Filettato / Threaded MA 5.  
H. 95 X L.95 mm.  
Art. 14.106



Filettato / Threaded MA 4  
H. 10 X Ø 40  
Art.14.107



Filettato / Threaded MA 4  
H.7 X Ø 38 mm.  
Art. 14.108



Filettato / Threaded MA 4  
H.7 X Ø 66 mm.  
Art. 14.109



H.18 - Spessore 4 mm.  
Art. 14.109.01 Ø 60 mm.  
Foro/Hole Ø 6 mm.



Filettato / Threaded MA 6  
Spessore 8 mm.  
Art. 14.109.02 Ø 55 mm.



Filettato / Threaded MA 6  
Spessore 13 mm.  
Art. 14.109.03 Ø 78 mm.



Tutte le parti di questo catalogo - foto comprese - sono di proprietà Euro-Fer. La riproduzione, anche parziale, è vietata in ogni forma e con ogni mezzo. / Every part of this catalogue - photos included - is Euro-Fer's property. All forms of copying are strictly prohibited.



## Decorazioni in Acciaio e Ottone Brass and Steel Decorations



Filettato / Threaded MA 6  
H.85 X L.55mm.  
Art. 14.109.04  
Spessore/Thickness 4 mm.



Spessore 2 mm.  
Art. 14.110 Ø 20 mm.  
Art. 14.111 Ø 25 mm.  
Art. 14.112 Ø 30 mm.  
Art. 14.113 Ø 35 mm.  
Art. 14.114 Ø 40 mm.  
Art. 14.115 Ø 50 mm.  
Art. 14.116 Ø 60 mm.

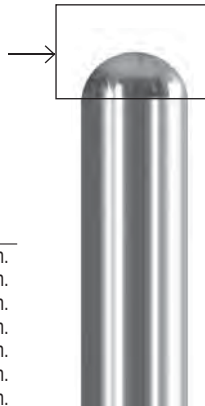

H.200 X L.70 mm.  
Art. 14.151



H.200 X L.60 mm.  
Art. 14.152



Filettato / Threaded MA 8  
H.115 X L.58 mm.  
Art. 14.118 Ø 20 mm  
H.140 X L.70 mm. MA8  
Art. 14.119 Ø 26 mm



Filettato / Threaded MA 8  
H.150 X L.60 mm.  
Art. 14.120 Ø 25 mm



H.180 X L.60 mm.  
Art. 14.153



H. 250 X L.48 mm  
Art. 14.160  
Ø 6 mm

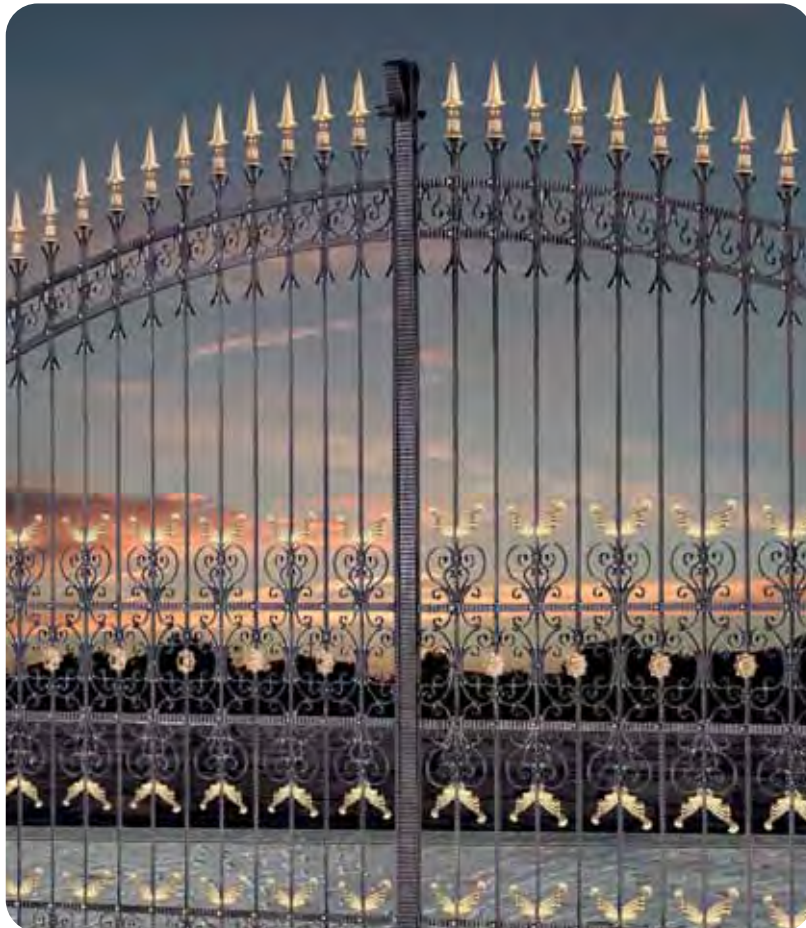



Gli articoli della Linea Liberty possono includere particolari in ghisa o ferro fuso.  
*The items of the Liberty Line could contain casting parts.*



Sinistro / *Left*  
H. 180 X L.150 mm.  
**Art. 14.200**  
Spessore 4 mm.



Destro / *Right*  
H. 180 X L.150 mm.  
**Art. 14.201**  
Spessore 4 mm.



Sinistro / *Left*  
H. 130 X L.55 mm.  
**Art. 14.202**  
Spessore 4 mm.



Destro / *Right*  
H. 130 X L.55 mm.  
**Art. 14.203**  
Spessore 4 mm.



Sinistro / *Left*  
H. 200 X L.150 mm.  
**Art. 14.204**  
Spessore 5 mm.  
Base Ø 12



Destro / *Right*  
H. 200 X L.150 mm.  
**Art. 14.205**  
Spessore 5 mm.  
Base Ø 12.



Sinistro / *Left*  
H. 115 X L.170 mm  
**Art. 14.206**  
Ø 12 mm



Destro / *Right*  
H. 115 X L.170 mm  
**Art. 14.207**  
Ø 12 mm



Sinistro / *Left*  
H. 190 X L.180 mm  
**Art. 14.208**



Destro / *Right*  
H. 190 X L.180 mm  
**Art. 14.209**



Sinistro / *Left*  
H. 130 X L.150 mm  
**Art. 14.210**



Destro / *Right*  
H. 130 X L.150 mm  
**Art. 14.211**



Sinistro / *Left*  
H. 175 X L.130 mm  
**Art. 14.212**  
Ø 12 mm



Destro / *Right*  
H. 175 X L.130 mm  
**Art. 14.213**  
Ø 12 mm



Sinistro / *Left*  
H. 235 X L.130 mm  
**Art. 14.214**



Destro / *Right*  
H. 235 X L.130 mm  
**Art. 14.215**



Sinistro / *Left*  
H. 90 X L.95 mm  
**Art. 14.216**  
Ø 12 mm



Destro / *Right*  
H. 90 X L.95 mm  
**Art. 14.217**  
Ø 12 mm



Sinistro / *Left*  
H. 135 X L.105 mm  
**Art. 14.218**



Destro / *Right*  
H. 135 X L.105 mm  
**Art. 14.219**





Sinistro / Left  
H. 160 X L.125 mm  
Art. 14.220



Destro / Right  
H. 160 X L.125 mm  
Art. 14.221



Sinistro / Left  
H. 110 X L.95 mm  
Art. 14.222



Destro / Right  
H. 110 X L.95 mm  
Art. 14.223



Sinistro / Left  
H. 100 X L.80 mm  
Art. 14.224



Destro / Right  
H. 100 X L.80 mm  
Art. 14.225



Sinistro / Left  
H. 80 X L.60 mm  
Art. 14.226



Destro / Right  
H. 80 X L.60 mm  
Art. 14.227



Base 110 mm  
Art. 14.250  
Spessore 14 mm



Base 89 mm  
Art. 14.251  
Spessore 25 mm



Base 97 mm  
Art. 14.252  
Spessore 14 mm



H.140 X L.115 mm  
Art. 14.253  
Ø 12 mm



Base 50 mm  
Art. 14.254  
Spessore 3 mm



H.275 X L.88 mm  
Art. 14.270  
Spessore 3 mm



H.242 X L.70 mm  
Art. 14.271  
Spessore 3 mm







H. 175 X L.60 mm.  
**Art. 15.001**  
Spessore 10 mm.



H. 135 X L.45 mm.  
**Art. 15.002**  
Spessore 10 mm.



H. 165 X L.55 mm.  
**Art. 15.003**  
Spessore 10 mm.



Martellato / *Hammered*  
**Art. 15.003.01**  
≠ 30 X 8 mm.

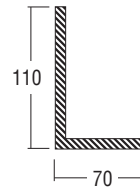

Martellato / *Hammered*  
**Art. 15.003.02**  
≠ 40 X 8 mm.



Martellato / *Hammered*  
H. 300 X L.40 mm.  
**Art. 15.003.03**  
≠ 25 X 8 mm.



Martellato / *Hammered*  
H. 300 X L.45 mm.  
**Art. 15.003.04**  
≠ 30 X 8 mm.



Martellato / *Hammered*  
H. 300 X L.55 mm.  
**Art. 15.003.05**  
≠ 40 X 8 mm.



H. 180 X L.85 mm.  
**Art. 15.003.06** Ø 12 mm.



H. 180 X L.85 mm.  
**Art. 15.003.07** □ 10 mm.



H. 110 mm.  
**Art. 15.003.08** Ø 10 mm.

**NEW**

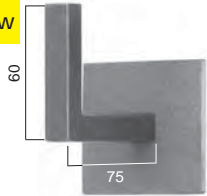

Piastra/Plate H.60 X 60 mm. ≠ 5 mm.  
**Art. 15.005.10** □ 12 mm.

**NEW**

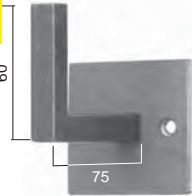

Piastra/Plate H.60 X 60 mm. ≠ 5 mm.  
**Art. 15.005.11** □ 12 mm.  
forata / holed



H. 180 X L.95 mm.  
**Art. 15.004** □ 14 X 14 mm.

**NEW**



H.180 L.95 mm.  
**Art. 15.004.01** Ø 14 mm.



H. 120 X L.130 mm.  
**Art. 15.005** □ 14 X 14 mm.



H. 500 mm.  
**Art. 15.006.01** ≠ 80 X 8 mm.  
**Art. 15.006.02** ≠ 100 X 8 mm.  
**Art. 15.006.03** ≠ 120 X 8 mm.



H. 800 mm.  
**Art. 15.006.04** ≠ 80 X 8 mm.  
**Art. 15.006.05** ≠ 100 X 8 mm.  
**Art. 15.006.06** ≠ 120 X 8 mm.



H. 240 X L.140 mm.  
**Art. 15.006** □ 12 X 12 mm.



Martellato / *Hammered*  
H. 300 mm.  
**Art. 15.006.13** □ 12 mm.

**NEW**



H. 420 X L. 270 mm.  
**Art. 15.006.14** ≠ 50 X 8 mm

**NEW**

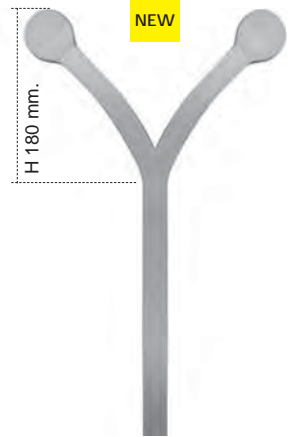

H. 180 mm.  
**Art. 15.006.15** □ 25 mm



H. 410 X L.195 mm.  
**Art. 15.007**  
□ 20 mm. ≙ 20 x 12

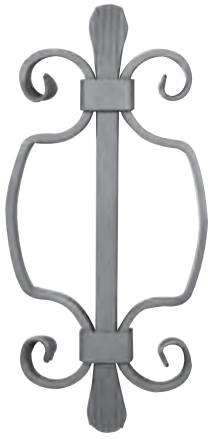

H. 410 X L.195 mm.  
**Art. 15.008**  
□ 20 mm. ≙ 20 x 8



H. 410 X L.165 mm.  
**Art. 15.009**  
□ 20 mm. ≙ 20 x 10

Foro / Hole Ø14



H. 130 X L.130 mm.  
**Art. 15.009.01**  
Spessore 12 mm.



Ø 112 mm.  
**Art. 15.009.02**  
Spessore 14 mm.



H. 300 mm.  
**Art. 15.010** □ 25 mm.  
**Art. 15.011** □ 30 mm.  
**Art. 15.012** □ 35 mm.  
**Art. 15.013** □ 40 mm.



H. 350 mm.  
**Art. 15.013.01** □ 25 mm.  
**Art. 15.013.02** □ 30 mm.  
**Art. 15.013.03** □ 35 mm.  
**Art. 15.013.04** □ 40 mm.



Martellato / *Hampered*  
H. 350 mm.  
**Art. 15.013.05** □ 25 mm.  
**Art. 15.013.06** □ 30 mm.  
**Art. 15.013.07** □ 35 mm.  
**Art. 15.013.08** □ 40 mm.

Tondo / *Round*  
H. 350 mm.  
**Art. 15.013.09** Ø 25 mm.  
**Art. 15.013.10** Ø 30 mm.  
**Art. 15.013.11** Ø 35 mm.  
**Art. 15.013.12** Ø 40 mm.

H. 350 mm.  
**Art. 15.013.13** □ 25 mm.  
**Art. 15.013.14** □ 30 mm.  
**Art. 15.013.15** □ 35 mm.  
**Art. 15.013.51** □ 40 mm.

Martellato / *Hampered*  
H. 350 mm.  
**Art. 15.013.16** □ 25 mm.  
**Art. 15.013.17** □ 30 mm.  
**Art. 15.013.18** □ 35 mm.  
**Art. 15.013.52** □ 40 mm.

Tondo / *Round*  
H. 350 mm.  
**Art. 15.013.19** Ø 25 mm.  
**Art. 15.013.20** Ø 30 mm.

H. 350 mm.  
**Art. 15.013.21** □ 25 mm.  
**Art. 15.013.22** □ 30 mm.

Martellato / *Hampered*  
H. 350 mm.  
**Art. 15.013.23** □ 25 mm.  
**Art. 15.013.24** □ 30 mm.



Tondo / *Round*  
H. 350 mm.  
**Art. 15.013.25** Ø 25 mm.  
**Art. 15.013.26** Ø 30 mm.

H. 350 mm.  
**Art. 15.013.27** □ 25 mm.  
**Art. 15.013.28** □ 30 mm.  
**Art. 15.013.29** □ 35 mm.  
**Art. 15.013.30** □ 40 mm.

Martellato / *Hampered*  
H. 350 mm.  
**Art. 15.013.31** □ 25 mm.  
**Art. 15.013.32** □ 30 mm.  
**Art. 15.013.33** □ 35 mm.  
**Art. 15.013.34** □ 40 mm.

H. 350 mm.  
**Art. 15.013.35** □ 25 mm.  
**Art. 15.013.36** □ 30 mm.  
**Art. 15.013.37** □ 35 mm.  
**Art. 15.013.38** □ 40 mm.

Martellato / *Hampered*  
H. 350 mm.  
**Art. 15.013.39** □ 25 mm.  
**Art. 15.013.40** □ 30 mm.  
**Art. 15.013.41** □ 35 mm.  
**Art. 15.013.42** □ 40 mm.

H. 360 mm.  
**Art. 15.013.45** □ 25 mm.  
**Art. 15.013.46** □ 30 mm.  
**Art. 15.013.47** □ 35 mm.

Martellato / *Hampered*  
H. 360 mm.  
**Art. 15.013.48** □ 25 mm.  
**Art. 15.013.49** □ 30 mm.  
**Art. 15.013.50** □ 35 mm.



Martellato / *Hammered*  
H. 350 mm  
Art. 15.013.60 □ 25 mm  
Art. 15.013.61 □ 30 mm

Liscio / *Smooth*  
H. 350 mm  
Art. 15.013.62 □ 25 mm  
Art. 15.013.63 □ 30 mm  
Art. 15.013.64 Ø 25 mm  
Art. 15.013.65 Ø 30 mm

Martellato / *Hammered*  
H. 300 mm.  
Art. 15.014 □ 25 mm.  
Art. 15.015 □ 30 mm.

Mod. Scala / *Scala Model*  
H. 350 mm.  
Art. 15.015.01 □ 25 mm.  
Art. 15.015.02 □ 30 mm.

H. 350 mm.  
Art. 15.015.03 □ 25 mm.  
Art. 15.015.04 □ 30 mm.

Martellato / *Hammered*  
H. 350 mm.  
Art. 15.015.05 □ 25 mm.  
Art. 15.015.06 □ 30 mm.

Tondo / *Round*  
H. 350 mm.  
Art. 15.015.07 Ø 25 mm.  
Art. 15.015.08 Ø 30 mm.



Tondo Lavorato  
*Worked Round Bar*  
H. 350 mm.  
Art. 15.015.09 Ø 25 mm.  
Art. 15.015.10 Ø 30 mm.

Martellato / *Hammered*  
H. 300 mm.  
Art. 15.016 □ 25 mm.  
Art. 15.017 □ 30 mm.  
Art. 15.017.01 □ 35 mm.  
Art. 15.017.02 □ 40 mm.  
Art. 15.017.03 □ 25 mm. Liscio/Smooth  
Art. 15.017.04 □ 30 mm. Liscio/Smooth  
Art. 15.017.05 □ 35 mm. Liscio/Smooth  
Art. 15.017.06 □ 40 mm. Liscio/Smooth

Mod. Scala / *Scala Model*  
H. 350 mm.  
Art. 15.017.07 □ 25 mm.  
Art. 15.017.08 □ 30 mm.  
Art. 15.017.09 □ 35 mm.

H. 350 mm.  
Art. 15.017.10  
≠ 30 x 20

Martellato / *Hammered*  
H. 350 mm.  
Art. 15.017.11  
≠ 30 x 20

Martellato / *Hammered*  
H. 350 mm.  
Art. 15.017.12 □ 25 mm.  
Liscio / *Smooth*  
H. 350 mm.  
Art. 15.017.13 □ 25 mm.

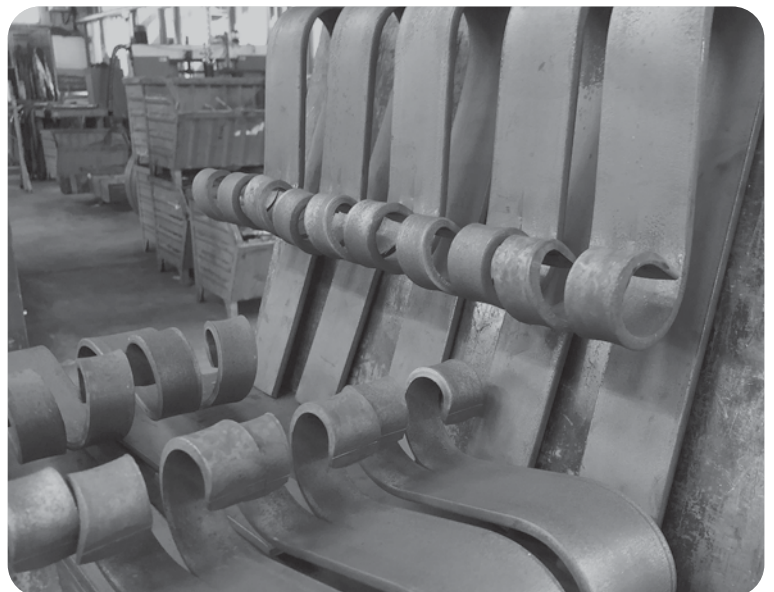

Tutte le parti di questo catalogo - foto comprese - sono di proprietà Euro-Fer. La riproduzione, anche parziale, è vietata in ogni forma e con ogni mezzo. / Every part of this catalogue - photos included - is Euro-Fer's property. All forms of copying are strictly prohibited.



**CIMASE, TERMINALI ED ELEMENTI VARI  
ORNAMENTS FOR CARRIAGE GATES AND VARIOUS ELEMENTS**



H. 300 mm.  
**Art. 15.018**  
≠ 70 X 6 mm.  
**Art. 15.018.50**  
≠ 50 X 6 mm.  
**Art. 15.018.51**  
≠ 60 X 6 mm.  
**Art. 15.018.52**  
≠ 80 X 6 mm.



Mod. Scala / Scala Model  
H. 350 mm.  
**Art. 15.018.01**  
≠ 60 X 8 mm.



H. 350 mm.  
**Art. 15.018.02**  
≠ 40 X 6 mm.  
**Art. 15.018.03**  
≠ 50 X 6 mm.



H. 300 mm.  
**Art. 15.018.04**  
≠ 40 X 6 mm.  
**Art. 15.018.05**  
≠ 50 X 6 mm.  
**Art. 15.018.06**  
≠ 60 X 6 mm.



H. 350 mm.  
**Art. 15.018.07**  
≠ 50 X 8 mm.



Martellato / Hammered  
H. 350 mm.  
**Art. 15.018.08**  
≠ 50 X 8 mm.



H. 350 mm.  
**Art. 15.018.09**  
≠ 50 X 10 mm.



Mod. Scala / Scala Model  
H. 350 mm.  
**Art. 15.018.10**  
≠ 60 X 8 mm.



Battuto / Beaten  
H. 350 mm.  
**Art. 15.018.11**  
≠ 60 X 8 mm.



H. 300 mm.  
**Art. 15.019**  
≠ 70 X 6 mm.

**Ribattini Martellati  
Hammered-Head Rivets**



Fuori Produzione  
Out of Production

**Art. 15.019.01**



Fuori Produzione  
Out of Production

**Art. 15.019.02**



Fuori Produzione  
Out of Production

**Art. 15.019.03**



H. 60 X L. 100 mm.  
**Art. 15.021.03**  
Spessore 35 mm.



H. 60 X L. 60 mm.  
**Art. 15.021.04**  
Spessore 40 mm.



H. 35 mm. - Ø 100 mm  
**Art. 15.021.08**  
Spessore 12 mm.



L. 105 mm  
≠ 40 x 8 mm  
**Art. 15.021.50**  
foro/hole Ø 35 x 17 mm

**Chiodi di Ferro  
Iron Nails**



**Art. 15.019.23** H. 230 □ 10 mm.  
**Art. 15.019.27** H. 270 □ 10 mm.  
**Art. 15.019.30** H. 300 □ 10 mm.



Spessore 10 mm.  
**Art. 15.021**  
□ Foro 32 mm.

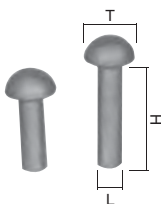

**Art. 15.022** L. 6 X H. 20 T. 11/12 mm.  
**Art. 15.023** L. 6 X H. 25 T. 11/12 mm.  
**Art. 15.024** L. 6 X H. 30 T. 11/12 mm.  
**Art. 15.025** L. 6 X H. 35 T. 11/12 mm.  
**Art. 15.026** L. 6 X H. 40 T. 11/12 mm.  
**Art. 15.027** L. 6 X H. 45 T. 11/12 mm.  
**Art. 15.028** L. 6 X H. 50 T. 11/12 mm.

**Art. 15.029** L. 8 X H. 20 T. 13/14 mm.  
**Art. 15.030** L. 8 X H. 25 T. 13/14 mm.  
**Art. 15.031** L. 8 X H. 30 T. 13/14 mm.  
**Art. 15.032** L. 8 X H. 35 T. 13/14 mm.  
**Art. 15.033** L. 8 X H. 40 T. 13/14 mm.  
**Art. 15.034** L. 8 X H. 45 T. 13/14 mm.  
**Art. 15.035** L. 8 X H. 50 T. 13/14 mm.

**Art. 15.036** L. 10 X H. 25 T. 17 mm.  
**Art. 15.037** L. 10 X H. 30 T. 17 mm.  
**Art. 15.038** L. 10 X H. 35 T. 17 mm.  
**Art. 15.039** L. 10 X H. 40 T. 17 mm.  
**Art. 15.040** L. 10 X H. 45 T. 17 mm.  
**Art. 15.041** L. 10 X H. 50 T. 17 mm.

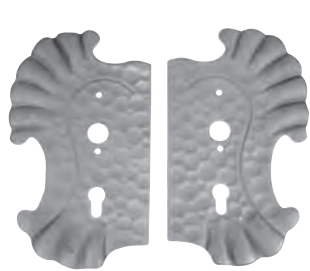

H. 275 X L.160 mm.

H. 275 X L.160 mm.

H. 260 X L.115 mm.

H. 260 X L.115 mm.

H. 295 X L.130 mm.

H. 295 X L.130 mm.

H. 230 X L.80 mm.

H. 300 X L.105 mm.

**Art. 15.042**

**Art. 15.043**

**Art. 15.044**

**Art. 15.045**

**Art. 15.046**

**Art. 15.047**

**Art. 15.048**

**Art. 15.049**

Spessore 3 mm.

Spessore 3 mm.

Spessore 3 mm.

Spessore 3 mm.

Spessore 3 mm.

Spessore 3 mm.

Spessore 6 mm.

Spessore 6 mm.

**Art. 15.042.01**  
Senza Foro  
Without Hole

**Art. 15.043.01**  
Senza Foro  
Without Hole

**Art. 15.044.01**  
Senza Foro  
Without Hole

**Art. 15.045.01**  
Senza Foro  
Without Hole

**Art. 15.046.01**  
Senza Foro  
Without Hole

**Art. 15.047.01**  
Senza Foro  
Without Hole

SUPPORTI PER MENSOLE  
SUPPORTS FOR SHELVES  
colore nero / black colour



H.200 x L.90 mm

H. 200 X L.160 mm.

H. 155 X L.125 mm.

H. 225 X L.175 mm.

H. 280 X L.220 mm.

**Art. 15.049.10**

**Art. 15.050**

**Art. 15.050.01**

**Art. 15.050.02**

**Art. 15.050.03**

≠ 3 mm

≠ 20 X 4

Copricolonna saldati e molati  
Post caps welded and grinded

Copricolonna puntati in lamierino  
Post caps in iron sheet

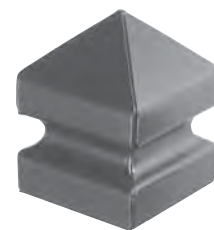

**Art. 15.059.001** H. 40 x 40 mm  
**Art. 15.059.002** H. 50 x 50 mm  
**Art. 15.059.003** H. 60 x 60 mm  
**Art. 15.059.004** H. 70 x 70 mm  
**Art. 15.059.005** H. 80 x 80 mm  
**Art. 15.059.006** H. 100 x 100 mm  
**Art. 15.059.007** H. 120 x 120 mm  
**Art. 15.059.008** H. 150 x 150 mm

**Art. 15.059.02** H.150 X L.150  
**Art. 15.059.03** H.120 X L.120  
**Art. 15.059.04** H.100 X L.100

Fabri Produzione  
Out of Production  
**Art. 15.051**

Copricolonna  
Post Caps



**Art. 15.052** □ 30 X 30  
**Art. 15.053** □ 40 X 40  
**Art. 15.054** □ 50 X 50  
**Art. 15.055** □ 60 X 60  
**Art. 15.056** □ 80 X 80  
**Art. 15.057** □ 100 X 100  
**Art. 15.058** □ 120 X 120  
**Art. 15.059** □ 150 X 150

Si raccomanda di zincare a caldo le sfere vuote in lamiera solo dopo averle forate  
It's recommended to perforate the Hollow Spheres before the hot galvanization



Sfera vuota / Hollow sphere

Sfera vuota / Hollow sphere

**Art. 15.059.05** □ 30x30 Ø 40 mm

**Art. 15.059.08** □ 60x60 Ø 60 mm

**Art. 15.059.06** □ 40x40 Ø 40 mm

**Art. 15.059.09** □ 80x80 Ø 80 mm

**Art. 15.059.07** □ 50x50 Ø 50 mm

**Art. 15.059.10** □ 100x100 Ø 100 mm

Ruota leggera mod. T gola tonda  
Light mod. T wheel-round groove

**Art. 15.060** 60 X 20 mm.  
**Art. 15.062** 80 X 20 mm.  
**Art. 15.063** 100 X 20 mm.  
**Art. 15.064** 120 X 20 mm.  
**Art. 15.065** 140 X 20 mm.

Ruota leggera mod. T a "V"  
Light mod. T wheel-"V" shaped

**Art. 15.072** 60 X 20 mm.  
**Art. 15.074** 80 X 20 mm.  
**Art. 15.075** 100 X 20 mm.  
**Art. 15.076** 120 X 20 mm.  
**Art. 15.077** 140 X 20 mm.

Ruota pesante mod. T gola tonda  
Heavy mod. T wheel-round groove

**Art. 15.067** 100 X 30 mm.  
**Art. 15.068** 120 X 30 mm.  
**Art. 15.069** 140 X 30 mm.  
**Art. 15.070** 160 X 30 mm.

Ruota pesante mod. T a "V"  
con doppio cuscinetto  
Heavy mod. T wheel-"V" shaped  
double bearing

**Art. 15.079** 100 X 30 mm.  
**Art. 15.080** 120 X 30 mm.  
**Art. 15.081** 140 X 30 mm.

Ruota con piastra a saldare gola tonda mod. T  
Mod. "T" wheel with plate to weld-round groove

**Art. 15.084** 120 X 20 mm.  
**Art. 15.086** 120 X 30 mm.



Ruota con piastra a saldare a "V" mod. T  
Mod. T wheel with plate to weld-"V" shaped

**Art. 15.088** 120 X 20 mm.  
**Art. 15.091** 140 X 30 mm.

Ruota a supporto interno mod. T gola tonda  
Mod. T wheel with internal support-round groove

**Art. 15.092** 120 X 20 mm.  
**Art. 15.093** 140 X 20 mm.  
**Art. 15.094** 120 X 30 mm.  
**Art. 15.095** 140 X 30 mm.



Ruota a supporto interno mod. T a "V"  
Mod. T wheel with internal support-"V" shaped

**Art. 15.096** 120 X 20 mm.

**CIMASE, TERMINALI ED ELEMENTI VARI  
ORNAMENTS FOR CARRIAGE GATES AND VARIOUS ELEMENTS**



Cardine a barra lunga  
*Long bar hinge*  
Zincato / Zinc-Plated  
Art. 15.102 Ø 18 MA  
Art. 15.103 Ø 22 MA



Cardine a muro  
*Hinge wall*  
Zincato / Zinc-Plated  
Art. 15.107 Ø 18 MA  
Art. 15.108 Ø 22 MA  
Art. 15.109 Ø 27 MA



Cardine a saldare  
*Hinge -Welding hinge*  
Zincato / Zinc-Plated  
Art. 15.113 Ø 18 MA  
Art. 15.114 Ø 22 MA  
Art. 15.115 Ø 27 MA



Cardine a regolazione ortogona-  
nale (con vite a perno zincati)  
*Right-angle adjustment hinge*  
(whit galvanized screw and pin)  
Art. 15.116 Ø 18 MA  
Art. 15.117 Ø 22 MA  
Art. 15.118 Ø 27 MA



Zincato / Zinc-Plated  
Art. 15.122 H.15 X L.60 mm.  
Art. 15.123 H.20 X L.70 mm.  
Art. 15.124 H.20 X L.80 mm.



Zincato / Zinc-Plated  
Art. 15.128 H. 89 mm. Ø 20 mm.  
Art. 15.129 H. 98 mm. Ø 23mm.  
Art. 15.130 H.105 mm. Ø 28 mm.



Zincato / Zinc-Plated  
Art. 15.131 Cardine 18 MA per □30 - piastra 90 X 90 X 4  
Art. 15.132 Cardine 22 MA per □35 - piastra 110 X 110 X 5  
Art. 15.133 Cardine 27 MA per □40 - piastra 130 X 130 X 5



Zincato / Zinc-Plated  
Art. 15.134 Cardine 18 MA regolabile per □30 - piastra 90 X 90 X 4  
Art. 15.135 Cardine 22 MA regolabile per □35 - piastra 110 X 110 X 5  
Art. 15.136 Cardine 27 MA regolabile per □40 - piastra 130 X 130 X 5

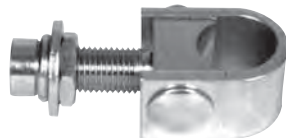

Zincato / Zinc-Plated  
Art. 15.137 Cardine 18 MA regolabile per □30  
Art. 15.138 Cardine 22 MA regolabile per □35  
Art. 15.139 Cardine 27 MA regolabile per □40



Zincato / Zinc-Plated  
Art. 15.140 Cardine 18 MA con orecchie saldate su piastra 90 X 90 X 4  
Art. 15.141 Cardine 22 MA con orecchie saldate su piastra 110 X 110 X 5  
Art. 15.142 Cardine 27 MA con orecchie saldate su piastra 130 X 130 X 5

Accessori per cancelli in ferro battuto /  
Perni di collegamento e guida superiore  
*Connection pins and upper guide*

Accessories for wrought iron gates  
Perni di collegamento e guida inferiore  
*Connection pins and lower guide*



Art. 15.143  
Perno sup. per cardine  
Ø 24 per tub. □30X 3

Art. 15.144  
Perno sup. per cardine  
Ø 29 per tub. □35X 3

Art. 15.145  
Perno sup. per cardine  
Ø 34 per tub. □40X 3



Art. 15.146  
Perno sup. per cardine  
Ø 30 per ■30X 3

Art. 15.147  
Perno sup. per cardine  
Ø 35 per ■35X 3

Art. 15.148  
Perno sup. per cardine  
Ø 40 per ■40X 3



Art. 15.149  
Perno inf. per cardine  
Ø 19 A

Art. 15.150  
Perno inf. per cardine  
Ø 22A

Art. 15.151  
Perno inf. per cardine  
Ø 27A

Cerniere con cuscinetti a sfere  
*Hinge with ball bearings*



H. 80 mm.  
Art. 15.151.01  
Ø 12 mm.  
H. 140 mm.  
Art. 15.151.02  
Ø 16,5 mm.



H. 100 mm.  
Art. 15.151.03  
Ø 13,5 mm.  
H. 140 mm.  
Art. 15.151.04  
Ø 16,5 mm.



Art. 15.151.05  
H. 185 mm.  
Art. 15.151.06  
Ø 28 mm.



H. 100 mm.  
Art. 15.151.07  
Ø 20 mm.



H. 120 mm.  
Art. 15.151.08  
Ø 24 mm.



H. 145 mm.  
Art. 15.151.09  
Ø 30 mm.



H. 200 mm.  
Art. 15.151.10  
Ø 30 mm.



Tutti i Fori sono Ø 11 / All Holes Ø 11

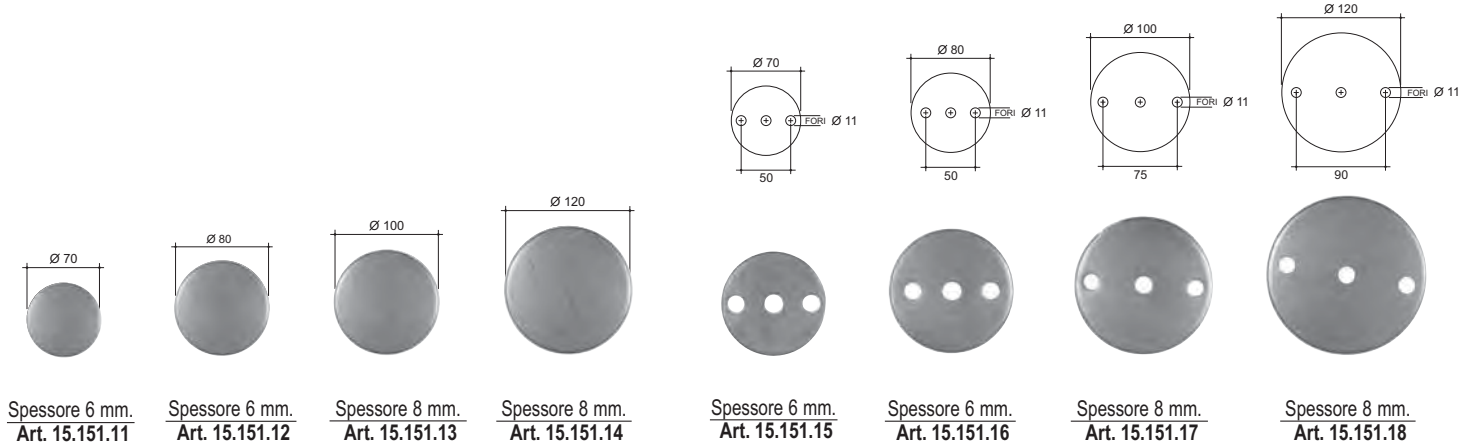

Tutti i Fori sono Ø 11 / All Holes Ø 11

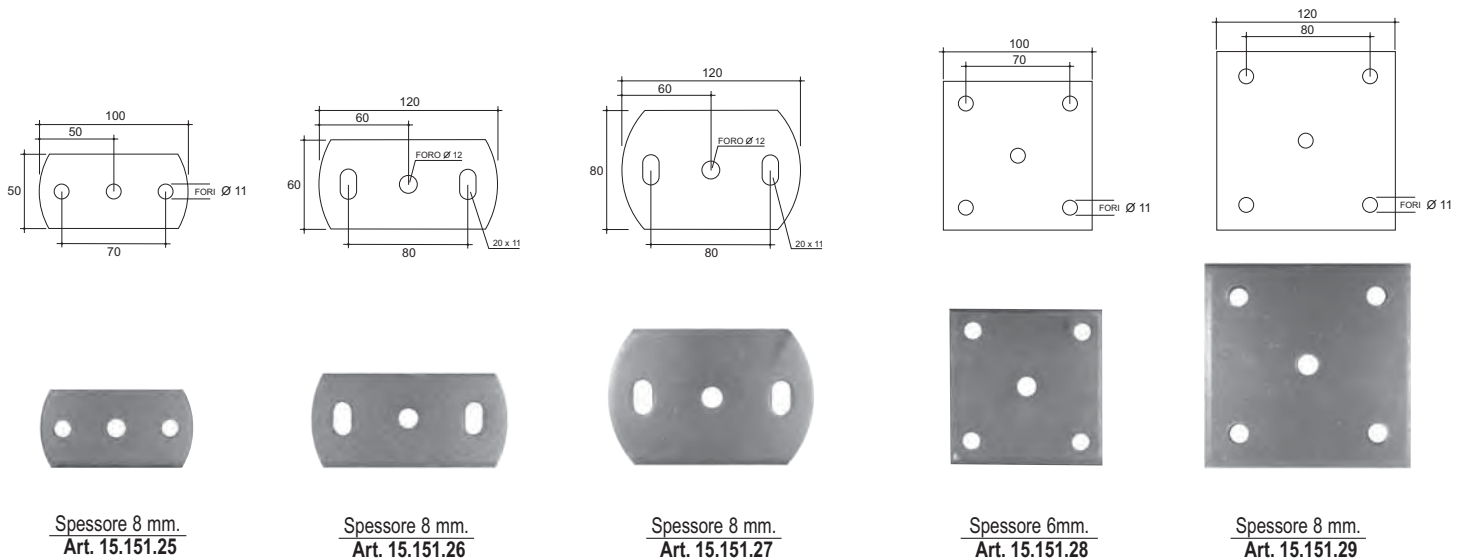
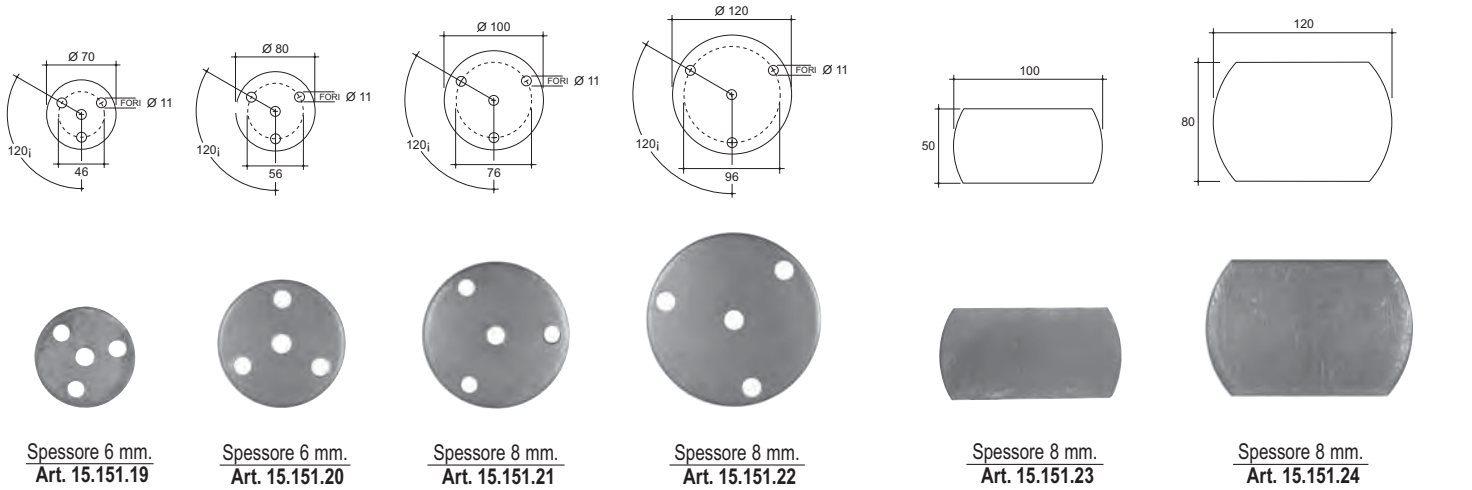

Tutte le parti di questo catalogo - foto comprese - sono di proprietà Euro-Fer. La riproduzione, anche parziale, è vietata in ogni forma e con ogni mezzo. / Every part of this catalogue - photos included - is Euro-Fer's property. All forms of copying are strictly prohibited.

**Articoli forniti in coppia / These pieces are furnished in pair**

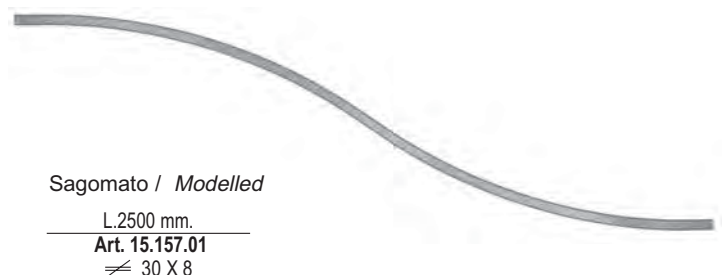
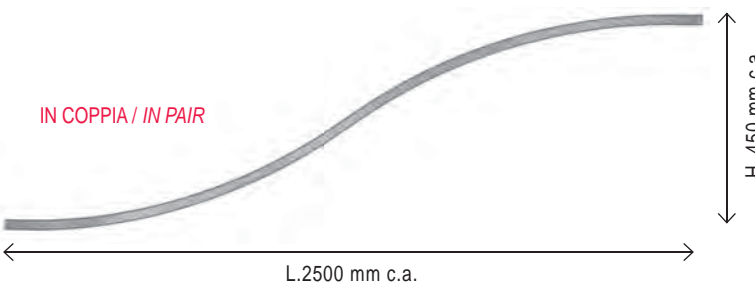
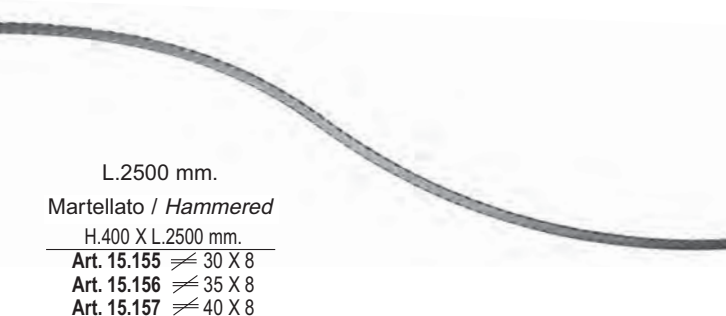
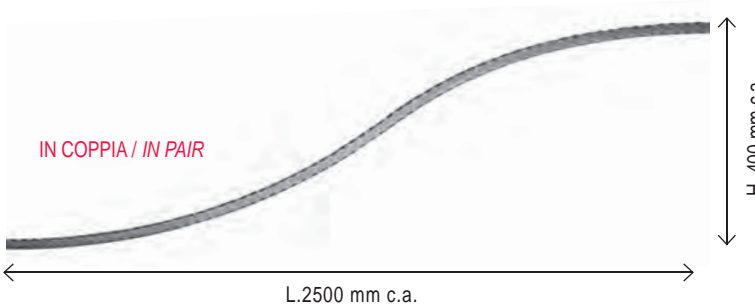
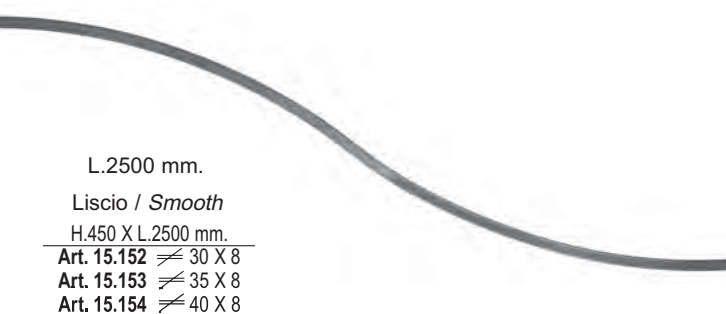
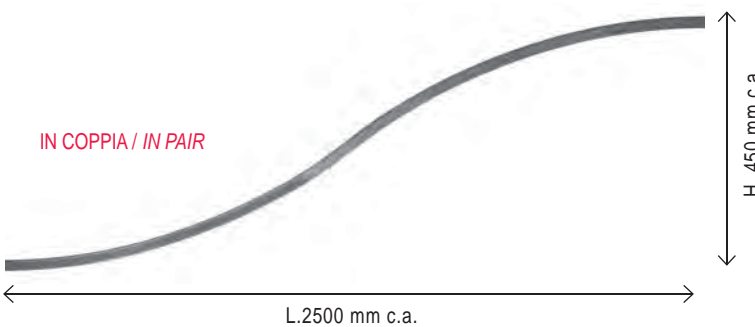
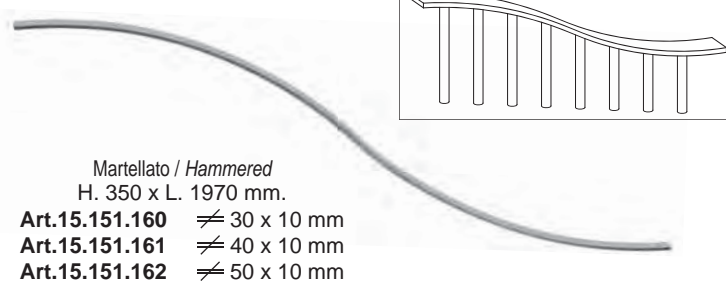
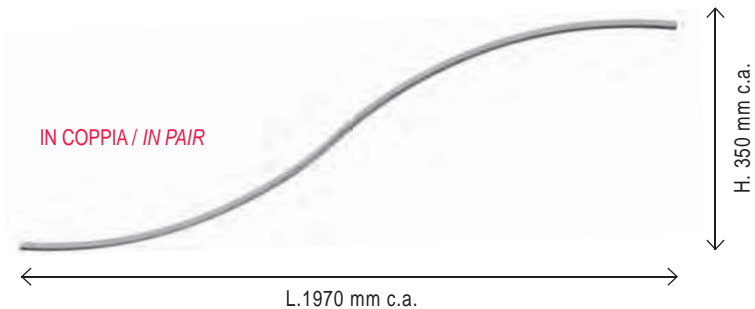
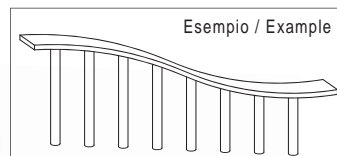
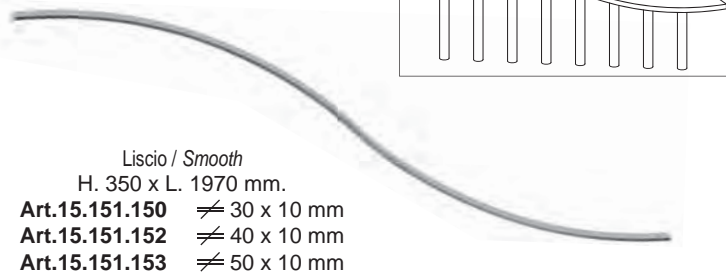
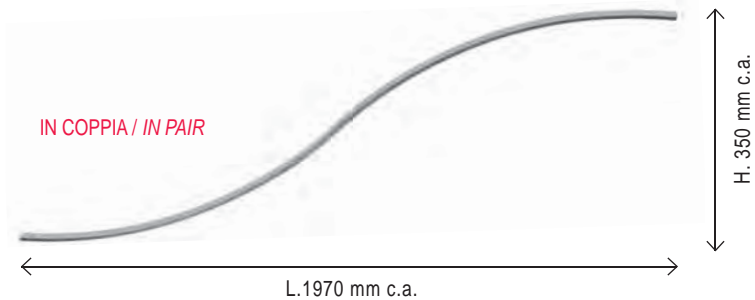
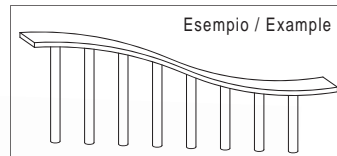

Tutte le parti di questo catalogo - foto comprese - sono di proprietà Euro-Fer. La riproduzione, anche parziale, è vietata in ogni forma e con ogni mezzo. / Every part of this catalogue - photos included - is Euro-Fer's property. All forms of copying are strictly prohibited.

**Articoli forniti in coppia / These pieces are furnished in pair**

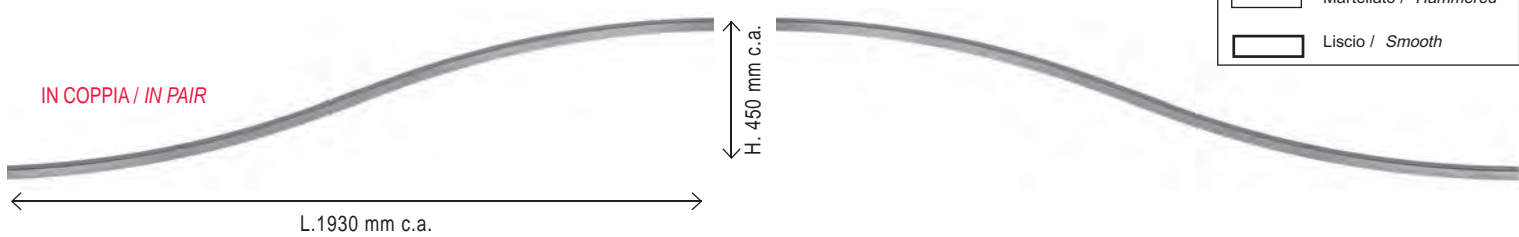
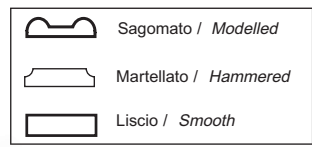

**Tubolare Martellato / Hammered Bars**

L.1930 mm. H. 450 mm.	
Art. 15.157.04	≧ 30 X 30
Art. 15.157.05	≧ 40 X 20

**Tubolare Liscio / Smooth Bars**

L.1930 mm. H. 450 mm.	
Art. 15.157.02	≧ 30 X 30
Art. 15.157.03	≧ 40 X 20

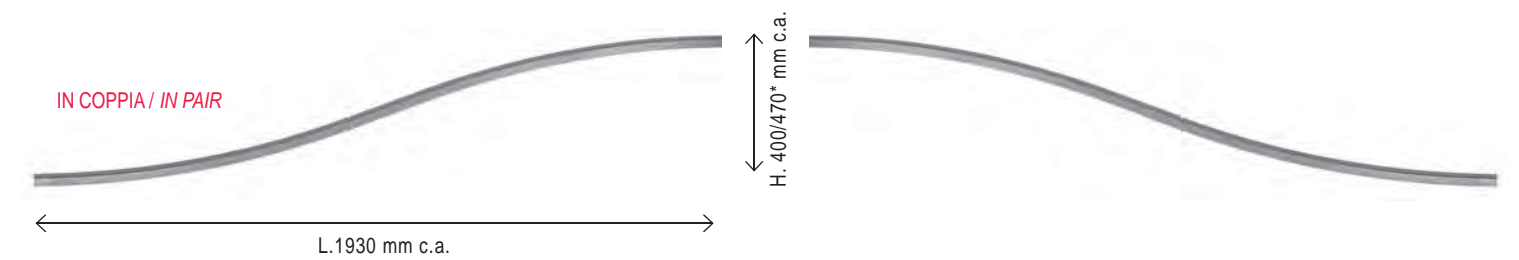

**Martellato / Hammered**

L.1930 mm. H. 400 mm.*	
Art. 15.157.06	≧ 30 X 8
Art. 15.157.08	≧ 35 X 8
Art. 15.157.10	≧ 40 X 8

**Sagomato / Modelled**

L.1930 mm. H. 470 mm.*	
Art. 15.157.12	≧ 30 X 8

**Liscio / Smooth**

L.1930 mm. H. 470 mm.*	
Art. 15.157.14	≧ 30 X 8
Art. 15.157.15	≧ 35 X 8
Art. 15.157.16	≧ 40 X 8

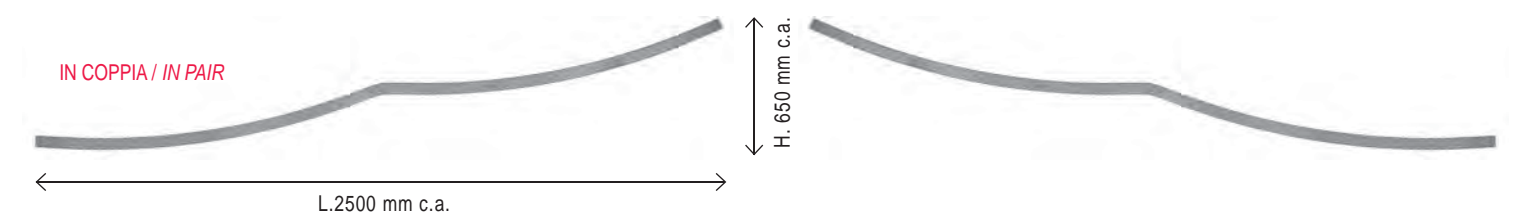

**Martellato / Hammered**

L.2500 mm.	
Art. 15.157.17	≧ 30 X 8
Art. 15.157.18	≧ 35 X 8
Art. 15.157.19	≧ 40 X 8

**Sagomato / Modelled**

L.2500 mm.	
Art. 15.157.20	≧ 30 X 8

**Liscio / Smooth**

L.2500 mm.	
Art. 15.157.21	≧ 30 X 8
Art. 15.157.22	≧ 35 X 8
Art. 15.157.23	≧ 40 X 8

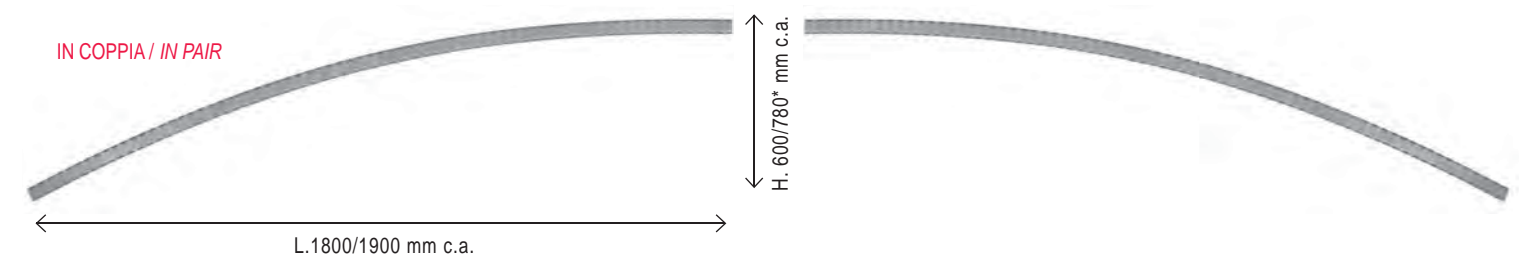

**Martellato / Hammered**

L. 1900 mm. H. 600 mm.*	
Art. 15.157.24	≧ 30 X 8
Art. 15.157.25	≧ 35 X 8
Art. 15.157.26	≧ 40 X 8

**Fuori Produzione  
Out of Production**

Mod. Scala / Scala Model

L. 1800 mm. H. 780 mm.*	
Art.15.157.27	≧ 30 x 8 mm
Art.15.157.28	≧ 35 x 8 mm
Art.15.157.29	≧ 40 x 8 mm

**Liscio / Smooth**

L.1800 mm. H. 780 mm.*	
Art. 15.157.30	≧ 30 X 8
Art. 15.157.31	≧ 35 X 8
Art. 15.157.32	≧ 40 X 8

Tutte le parti di questo catalogo - foto comprese - sono di proprietà Euro-Fer. La riproduzione, anche parziale, è vietata in ogni forma e con ogni mezzo. / Every part of this catalogue - photos included - is Euro-Fer's property. All forms of copying are strictly prohibited.



**CIMASE, TERMINALI ED ELEMENTI VARI  
ORNAMENTS FOR CARRIAGE GATES AND VARIOUS ELEMENTS**

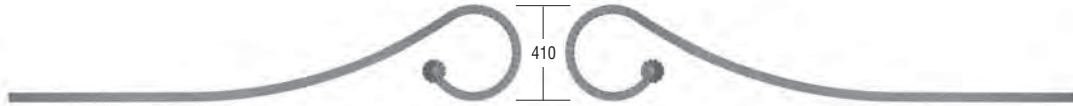

Sinistro / *Left*  
Martellato / *Hammered*  
L.2150 mm.  
Art. 15.157.33 ≙ 30 X 8  
Art. 15.157.35 ≙ 35 X 8  
Art. 15.157.37 ≙ 40 X 8

Sinistro / *Left*  
Liscio / *Smooth*  
L.2150 mm.  
Art. 15.157.39 ≙ 30 X 8  
Art. 15.157.41 ≙ 35 X 8  
Art. 15.157.43 ≙ 40 X 8

Destro / *Right*  
Martellato / *Hammered*  
L.2150 mm.  
Art. 15.157.34 ≙ 30 X 8  
Art. 15.157.36 ≙ 35 X 8  
Art. 15.157.38 ≙ 40 X 8

Destro / *Right*  
Liscio / *Smooth*  
L.2150 mm.  
Art. 15.157.40 ≙ 30 X 8  
Art. 15.157.42 ≙ 35 X 8  
Art. 15.157.44 ≙ 40 X 8



Sinistro / *Left*  
Martellato / *Hammered*  
L.2000 mm.  
Art. 15.157.45 ≙ 30 X 8  
Art. 15.157.47 ≙ 35 X 8  
Art. 15.157.49 ≙ 40 X 8

Liscio / *Smooth*  
L.2000 mm.  
Art. 15.157.51 ≙ 30 X 8  
Art. 15.157.52 ≙ 35 X 8  
Art. 15.157.53 ≙ 40 X 8

Destro / *Right*  
Martellato / *Hammered*  
L.2000 mm.  
Art. 15.157.46 ≙ 30 X 8  
Art. 15.157.48 ≙ 35 X 8  
Art. 15.157.50 ≙ 40 X 8

N.B.: Nel piatto liscio  
sinistro o destro sono uguali.  
Note: Right and left sides are equal in  
smooth flat sections.

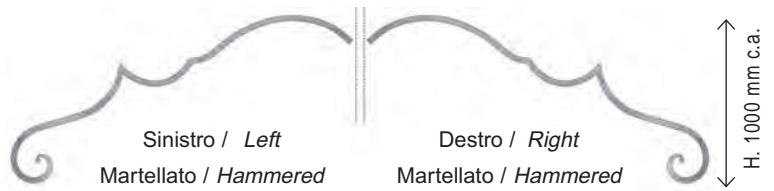

Sinistro / *Left*  
Martellato / *Hammered*  
L.2000 mm.  
Art. 15.157.54 ≙ 35 X 8  
Art. 15.157.56 ≙ 40 X 8

Liscio / *Smooth*  
L.2000 mm.  
Art. 15.157.58 ≙ 35 X 8  
Art. 15.157.59 ≙ 40 X 8

Destro / *Right*  
Martellato / *Hammered*  
L.2000 mm.  
Art. 15.157.55 ≙ 35 X 8  
Art. 15.157.57 ≙ 40 X 8

N.B.: Nel piatto liscio  
sinistro o destro sono uguali.  
Note: Right and left sides are equal in  
smooth flat sections.



Tutte le parti di questo catalogo - foto comprese - sono di proprietà Euro-Fer. La riproduzione, anche parziale, è vietata in ogni forma e con ogni mezzo. / Every part of this catalogue - photos included - is Euro-Fer's property. All forms of copying are strictly prohibited.

# CIMASE, TERMINALI ED ELEMENTI VARI ORNAMENTS FOR CARRIAGE GATES AND VARIOUS ELEMENTS

15

N.B.: Nel piatto liscio  
sinistro o destro sono uguali.  
Note: Right and left sides are equal in  
smooth flat sections.

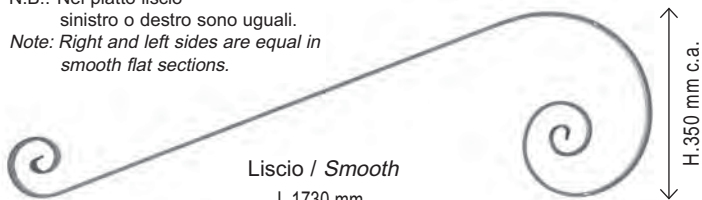

Liscio / Smooth  
L.1730 mm.  
Art. 15.157.60 ≙ 30 X 8  
Art. 15.157.61 ≙ 35 X 10  
Art. 15.157.62 ≙ 40 X 8

N.B.: Nel piatto liscio  
sinistro o destro sono uguali.  
Note: Right and left sides are equal in  
smooth flat sections.

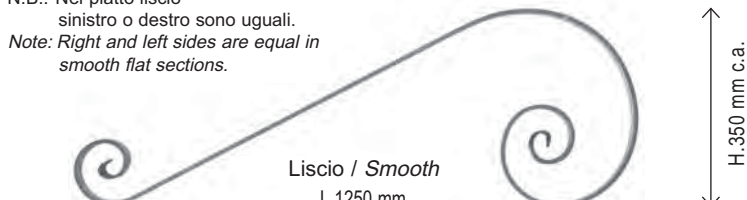

Liscio / Smooth  
L.1250 mm.  
Art. 15.157.63 ≙ 30 X 8  
Art. 15.157.64 ≙ 35 X 10  
Art. 15.157.65 ≙ 40 X 8



Liscio / Smooth  
L.1150 mm.  
Art. 15.157.66 ≙ 30 X 8  
Art. 15.157.67 ≙ 35 X 10  
Art. 15.157.68 ≙ 40 X 8

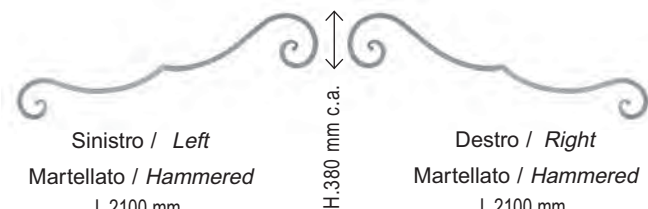

Sinistro / Left  
Martellato / Hammered  
L.2100 mm.  
Art. 15.157.69 ≙ 35 X 8  
Art. 15.157.71 ≙ 40 X 8

Destro / Right  
Martellato / Hammered  
L.2100 mm.  
Art. 15.157.70 ≙ 35 X 8  
Art. 15.157.72 ≙ 40 X 8

N.B.: Nel piatto liscio  
sinistro o destro sono uguali.  
Note: Right and left sides are equal in  
smooth flat sections.

Liscio / Smooth  
L.2100 mm.  
Art. 15.157.73 ≙ 35 X 8  
Art. 15.157.74 ≙ 40 X 8

N.B.: Nel piatto liscio  
sinistro o destro sono uguali.  
Note: Right and left sides are equal in  
smooth flat sections.



Sinistro / Left  
Martellato / Hammered  
L.2000 mm.  
Art. 15.157.75 ≙ 35 X 8  
Art. 15.157.77 ≙ 40 X 8

Destro / Right  
Martellato / Hammered  
L.2000 mm.  
Art. 15.157.76 ≙ 35 X 8  
Art. 15.157.78 ≙ 40 X 8

Liscio / Smooth  
L.2000 mm.  
Art. 15.157.79 ≙ 35 X 8  
Art. 15.157.80 ≙ 40 X 8

N.B.: Nel piatto liscio  
sinistro o destro sono uguali.  
Note: Right and left sides are equal in  
smooth flat sections.

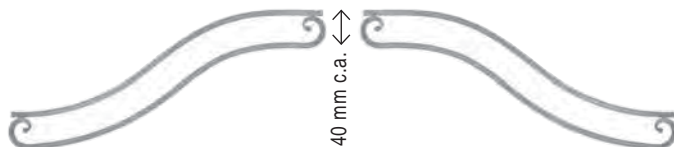

Sinistro / Left  
Martellato / Hammered  
L.2000 mm.  
Art. 15.157.81 ≙ 35 X 8  
Art. 15.157.83 ≙ 40 X 8

Destro / Right  
Martellato / Hammered  
L.2000 mm.  
Art. 15.157.82 ≙ 35 X 8  
Art. 15.157.84 ≙ 40 X 8

Liscio / Smooth  
L.2000 mm.  
Art. 15.157.85 ≙ 35 X 8  
Art. 15.157.86 ≙ 40 X 8

N.B.: Nel piatto liscio  
sinistro o destro sono uguali.  
Note: Right and left sides are equal in  
smooth flat sections.



Sinistro / Left  
Martellato / Hammered  
L.1900 mm.  
Art. 15.157.87 ≙ 35 X 8  
Art. 15.157.89 ≙ 40 X 8

Destro / Right  
Martellato / Hammered  
L.1900 mm.  
Art. 15.157.88 ≙ 35 X 8  
Art. 15.157.90 ≙ 40 X 8

Liscio / Smooth  
L.1900 mm.  
Art. 15.157.91 ≙ 35 X 8  
Art. 15.157.92 ≙ 40 X 8

N.B.: Nel piatto liscio  
sinistro o destro sono uguali.  
Note: Right and left sides are equal in  
smooth flat sections.

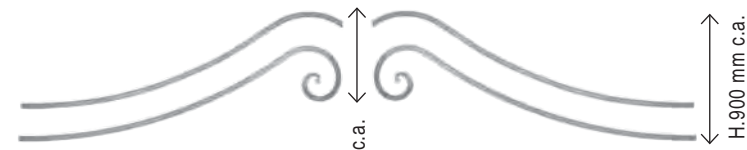

Sinistro / Left  
Martellato / Hammered  
L.2100 mm.  
Art. 15.157.93 ≙ 35 X 8  
Art. 15.157.95 ≙ 40 X 8

Destro / Right  
Martellato / Hammered  
L.2100 mm.  
Art. 15.157.94 ≙ 35 X 8  
Art. 15.157.96 ≙ 40 X 8

Liscio / Smooth  
L.2100 mm.  
Art. 15.157.97 ≙ 35 X 8  
Art. 15.157.98 ≙ 40 X 8

N.B.: Nel piatto liscio  
sinistro o destro sono uguali.  
Note: Right and left sides are equal in  
smooth flat sections.

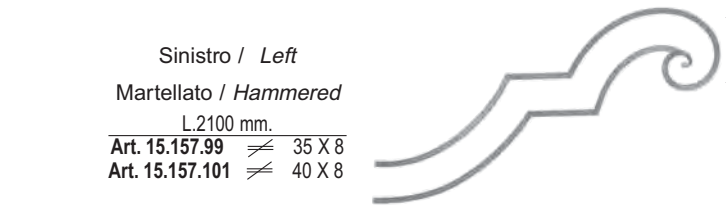

Sinistro / Left  
Martellato / Hammered  
L.2100 mm.  
Art. 15.157.99 ≙ 35 X 8  
Art. 15.157.101 ≙ 40 X 8

Liscio / Smooth  
L.2100 mm.  
Art. 15.157.103 ≙ 35 X 8  
Art. 15.157.104 ≙ 40 X 8

H.550 mm c.a.

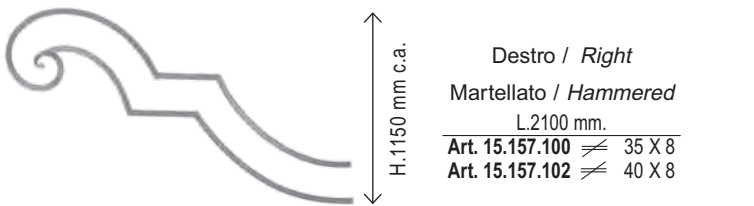

Destro / Right  
Martellato / Hammered  
L.2100 mm.  
Art. 15.157.100 ≙ 35 X 8  
Art. 15.157.102 ≙ 40 X 8

N.B.: Nel piatto liscio  
sinistro o destro sono uguali.  
Note: Right and left sides are equal in  
smooth flat sections.

H.1150 mm c.a.

Pezzi forniti singolarmente / These pieces are furnished separately

## CIMASE E CANCELLI PEDONALI



Liscio / Smooth

H.150 X L.1500 mm.

Art. 15.157.105 ≙ 30 X 8  
Art. 15.157.106 ≙ 35 X 8  
Art. 15.157.107 ≙ 40 X 8

Martellato / Hammered

H.150 X L.1500 mm.

Art. 15.157.108 ≙ 30 X 8  
Art. 15.157.109 ≙ 35 X 8  
Art. 15.157.110 ≙ 40 X 8



Tubolare Liscio  
Smooth Bars

H.150 X L.1450 mm.

Art. 15.157.114 □ 30 X 30  
Art. 15.157.115 □ 40 X 20

Tubolare Martellato  
Hammered Bars

H.150 X L.1450 mm.

Art. 15.157.116 □ 30 X 30  
Art. 15.157.117 □ 40 X 20



Liscio / Smooth

H.180 X L.1300 mm.

Art. 15.157.118 ≙ 30 X 8  
Art. 15.157.119 ≙ 35 X 8  
Art. 15.157.120 ≙ 40 X 8

Martellato / Hammered

H.180 X L.1300 mm.

Art. 15.157.121 ≙ 30 X 8  
Art. 15.157.122 ≙ 35 X 8  
Art. 15.157.123 ≙ 40 X 8



Liscio / Smooth

H.190 X L.1000 mm.

Art. 15.157.124 ≙ 30 X 8  
Art. 15.157.125 ≙ 35 X 10  
Art. 15.157.126 ≙ 40 X 8

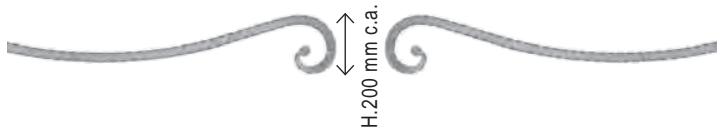

Sinistro / Left

Martellato / Hammered

H.200 X L.1000 mm.

Art. 15.157.127 ≙ 30 X 8  
Art. 15.157.129 ≙ 35 X 8

Destro / Right

Martellato / Hammered

H.200 X L.1000 mm.

Art. 15.157.128 ≙ 30 X 8  
Art. 15.157.130 ≙ 35 X 8

Liscio / Smooth

H.200 X L.1000 mm.

Art. 15.157.131 ≙ 30 X 8  
Art. 15.157.132 ≙ 35 X 8

N.B.: Nel piatto liscio  
sinistro o destro sono uguali.  
Note: Right and left sides are equal in  
smooth flat sections.

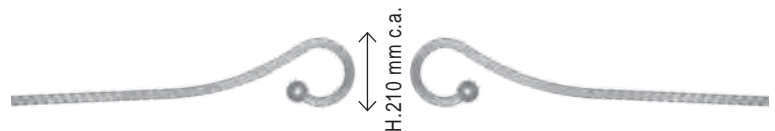

Sinistro / Left

Martellato / Hammered

H.210 X L.1000 mm.

Art. 15.157.133 ≙ 30 X 8  
Art. 15.157.135 ≙ 35 X 8

Destro / Right

Martellato / Hammered

H.210 X L.1000 mm.

Art. 15.157.134 ≙ 30 X 8  
Art. 15.157.136 ≙ 35 X 8

Sinistro / Left

Liscio / Smooth

H.210 X L.1000 mm.

Art. 15.157.137 ≙ 30 X 8  
Art. 15.157.138 ≙ 35 X 8

Destro / Right

Liscio / Smooth

H.210 X L.1000 mm.

Art. 15.157.193 ≙ 30 X 8  
Art. 15.157.194 ≙ 35 X 8

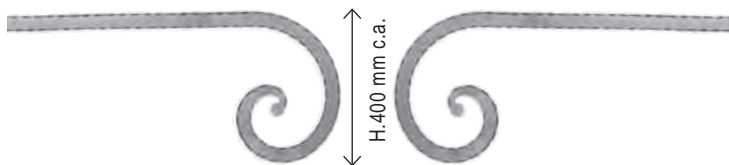

Sinistro / Left

Martellato / Hammered

H.400 X L.1000 mm.

Art. 15.157.139 ≙ 30 X 8  
Art. 15.157.141 ≙ 35 X 8  
Art. 15.157.143 ≙ 40 X 8

Destro / Right

Martellato / Hammered

H.400 X L.1000 mm.

Art. 15.157.140 ≙ 30 X 8  
Art. 15.157.142 ≙ 35 X 8  
Art. 15.157.144 ≙ 40 X 8

Liscio / Smooth

H.400 X L.1000 mm.

Art. 15.157.145 ≙ 30 X 8  
Art. 15.157.146 ≙ 35 X 8  
Art. 15.157.147 ≙ 40 X 8

N.B.: Nel piatto liscio  
sinistro o destro sono uguali.  
Note: Right and left sides are equal in  
smooth flat sections.

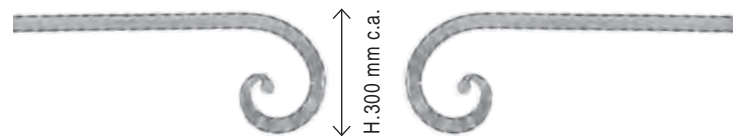

Sinistro / Left

Martellato / Hammered

H.300 X L.1000 mm.

Art. 15.157.148 ≙ 30 X 8  
Art. 15.157.150 ≙ 35 X 8  
Art. 15.157.152 ≙ 40 X 8

Destro / Right

Martellato / Hammered

H.300 X L.1000 mm.

Art. 15.157.149 ≙ 30 X 8  
Art. 15.157.151 ≙ 35 X 8  
Art. 15.157.153 ≙ 40 X 8

Liscio / Smooth

H.300 X L.1000 mm.

Art. 15.157.154 ≙ 30 X 8  
Art. 15.157.155 ≙ 35 X 8  
Art. 15.157.156 ≙ 40 X 8

N.B.: Nel piatto liscio  
sinistro o destro sono uguali.  
Note: Right and left sides are equal in  
smooth flat sections.



Pezzi forniti singolarmente / *These pieces are furnished separately*

**CIMASE E CANCELLI PEDONALI**



Sinistro / *Left*

Martellato / *Hammered*

H.200 X L.1000 mm.

- Art. 15.157.157 ≙ 30 X 8
- Art. 15.157.159 ≙ 35 X 8
- Art. 15.157.161 ≙ 40 X 8

Liscio / *Smooth*

H.200 X L.1000 mm.

- Art. 15.157.163 ≙ 30 X 8
- Art. 15.157.164 ≙ 35 X 8
- Art. 15.157.165 ≙ 40 X 8



Destro / *Right*

Martellato / *Hammered*

H.200 X L.1000 mm.

- Art. 15.157.158 ≙ 30 X 8
- Art. 15.157.160 ≙ 35 X 8
- Art. 15.157.162 ≙ 40 X 8

N.B.: Nel piatto liscio  
sinistro o destro sono uguali.

*Note: Right and left sides are equal in  
smooth flat sections.*



Sinistro / *Left*

Martellato / *Hammered*

H.400 X L.1000 mm.

- Art. 15.157.166 ≙ 30 X 8
- Art. 15.157.168 ≙ 35 X 8
- Art. 15.157.170 ≙ 40 X 8

Liscio / *Smooth*

H.400 X L.1000 mm.

- Art. 15.157.172 ≙ 30 X 8
- Art. 15.157.173 ≙ 35 X 8
- Art. 15.157.174 ≙ 40 X 8



Destro / *Right*

Martellato / *Hammered*

H.400 X L.1000 mm.

- Art. 15.157.167 ≙ 30 X 8
- Art. 15.157.169 ≙ 35 X 8
- Art. 15.157.171 ≙ 40 X 8

N.B.: Nel piatto liscio  
sinistro o destro sono uguali.

*Note: Right and left sides are equal in  
smooth flat sections.*



Sinistro / *Left*

Martellato / *Hammered*

H.300 X L.800 mm.

- Art. 15.157.175 ≙ 30 X 8
- Art. 15.157.177 ≙ 35 X 8
- Art. 15.157.179 ≙ 40 X 8

Liscio / *Smooth*

H.300 X L.800 mm.

- Art. 15.157.181 ≙ 30 X 8
- Art. 15.157.182 ≙ 35 X 8
- Art. 15.157.183 ≙ 40 X 8



Destro / *Right*

Martellato / *Hammered*

H.300 X L.800 mm.

- Art. 15.157.176 ≙ 30 X 8
- Art. 15.157.178 ≙ 35 X 8
- Art. 15.157.180 ≙ 40 X 8

N.B.: Nel piatto liscio  
sinistro o destro sono uguali.

*Note: Right and left sides are equal in  
smooth flat sections.*



Sinistro / *Left*

Martellato / *Hammered*

H.200 X L.500 mm.

- Art. 15.157.184 ≙ 30 X 8
- Art. 15.157.186 ≙ 35 X 8
- Art. 15.157.188 ≙ 40 X 8

Liscio / *Smooth*

H.200 X L.500 mm.

- Art. 15.157.190 ≙ 30 X 8
- Art. 15.157.191 ≙ 35 X 8
- Art. 15.157.192 ≙ 40 X 8



Destro / *Right*

Martellato / *Hammered*

H.200 X L.500 mm.

- Art. 15.157.185 ≙ 30 X 8
- Art. 15.157.187 ≙ 35 X 8
- Art. 15.157.189 ≙ 40 X 8

N.B.: Nel piatto liscio  
sinistro o destro sono uguali.

*Note: Right and left sides are equal in  
smooth flat sections.*





Sinistro / Left  
Martellato / Hammered  
H. 370 x L. 1500 mm.  
**Art.15.157.200**  $\neq$  30 x 8 mm

Liscio / Smooth  
H. 370 x L. 1500 mm.  
**Art.15.157.206**  $\neq$  30 x 8 mm



Destro / Right  
Martellato / Hammered  
H. 370 x L. 1500 mm.  
**Art.15.157.201**  $\neq$  30 x 8 mm

N.B.: Il piatto liscio sinistro o destro sono uguali.  
*Note: Right and left sides are equal in smooth flat sections.*

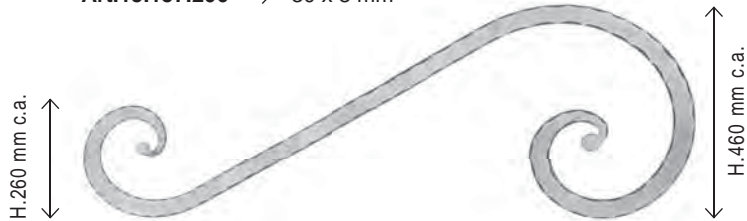

Sinistro / Left  
Martellato / Hammered  
H. 460 x L. 1500 mm.  
**Art.15.157.209**  $\neq$  30 x 8 mm

Liscio / Smooth  
H. 460 x L. 1500 mm.  
**Art.15.157.215**  $\neq$  30 x 8 mm



Destro / Right  
Martellato / Hammered  
H. 460 x L. 1500 mm.  
**Art.15.157.210**  $\neq$  30 x 8 mm

N.B.: Il piatto liscio sinistro o destro sono uguali.  
*Note: Right and left sides are equal in smooth flat sections.*



Sinistro / Left  
Martellato / Hammered  
H. 240 x L. 1500 mm.  
**Art.15.157.218**  $\neq$  30 x 8 mm

Liscio / Smooth  
H. 240 x L. 1500 mm.  
**Art.15.157.221**  $\neq$  30 x 8 mm



Destro / Right  
Martellato / Hammered  
H. 240 x L. 1500 mm.  
**Art.15.157.219**  $\neq$  30 x 8 mm

N.B.: Il piatto liscio sinistro o destro sono uguali.  
*Note: Right and left sides are equal in smooth flat sections.*



Sinistro / Left  
Martellato / Hammered  
H. 360 x L. 1500 mm.  
**Art.15.157.224**  $\neq$  30 x 8 mm

Liscio / Smooth  
H. 360 x L. 1500 mm.  
**Art.15.157.227**  $\neq$  30 x 8 mm



Destro / Right  
Martellato / Hammered  
H. 360 x L. 1500 mm.  
**Art.15.157.225**  $\neq$  30 x 8 mm

N.B.: Il piatto liscio sinistro o destro sono uguali.  
*Note: Right and left sides are equal in smooth flat sections.*



Sinistro / Left  
Martellato / Hammered  
H. 400 x L. 2100 mm.  
**Art.15.157.280**  $\neq$  30 x 8 mm

Liscio / Smooth  
H. 400 x L. 2100 mm.  
**Art.15.157.286**  $\neq$  30 x 8 mm

Destro / Right  
Martellato / Hammered  
H. 400 x L. 2100 mm.  
**Art.15.157.281**  $\neq$  30 x 8 mm

N.B.: Il piatto liscio sinistro o destro sono uguali.  
*Note: Right and left sides are equal in smooth flat sections.*





≅ 70 X L.6 mm.  
Art. 15.158 H. 300 mm.  
Art. 15.159 H.2000 mm.  
Art. 15.160 H.3000 mm.



Zincato/Galvanized    Zincato/Galvanized  
Art. 15.161                      Art. 15.162  
A = 40 mm.                      A = 45 mm.  
B = 60 mm.                      B = 45 mm.  
C = 20 mm.                      C = 24 mm.



H. 160 X L.30 mm.  
Art. 15.163



H. 130 X L.29 mm.  
Art. 15.163.01



H. 100 X L.20 mm.  
Art. 15.163.02



Perno / Pin  
Ø 16mm

Forgiato a mano / Hand Forged  
H. 328 x L. 110 mm  
Art. 15.210 ≅ 8

Cardini e cerniere forgiati a mano per portali / Hand forged hinges for front doors



Forgiato a mano / Hand Forged  
L. 780 mm  
Art. 15.200 ≅ 40 x 8  
fori / holes Ø 16,5 mm



Forgiato a mano / Hand Forged  
L. 740 mm  
Art. 15.201 ≅ 40 x 8  
fori / holes Ø 16,5 mm



**NEW**

H. 400 x L. 145 mm  
Art. 15.220  
sp./ thckn. 4 mm



Forgiato / Forged  
H. 525 x L. 105 mm  
Art. 15.250 □ 30 mm



Forgiato / Forged  
H. 610 x L. 180 mm  
Art. 15.251 □ 30 mm  
Art. 15.251.01 □ 25 mm



Forgiato / Forged  
H. 920 x L. 220 mm  
Art. 15.252 □ 30 mm  
Art. 15.252.01 □ 25 mm



Forgiato / Forged  
H. 650 x L. 285 mm  
Art. 15.253 □ 30 mm

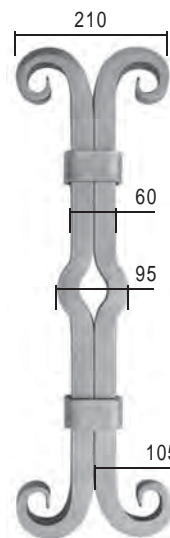

Forgiato / Forged  
H. 660 x L. 210 mm  
Art. 15.254 □ 30 mm

**NEW**

**NEW Art. 15.251.02 ≅ 50x20 mm**

Tutte le parti di questo catalogo - foto comprese - sono di proprietà Euro-Fer. La riproduzione, anche parziale, è vietata in ogni forma e con ogni mezzo. / Every part of this catalogue - photos included - is Euro-Fer's property. All forms of copying are strictly prohibited.



COMPONENTI VARI PER ARREDAMENTO  
VARIOUS DECOR ELEMENTS



L.120 mm.  
Art. 16.001



H.230 X L.60 mm.  
Art. 16.002



H.270 X L.60 mm.  
Art. 16.003



H.410 X L.100 mm.  
Art. 16.003.03 Ø 25 mm circa



H.400 X L.90 mm  
Art. 16.003.04



H.350 X L.75 mm  
Art. 16.003.05

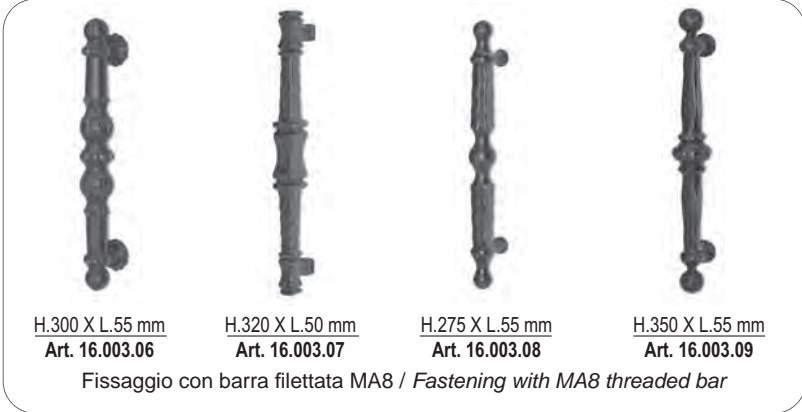

H.300 X L.55 mm  
Art. 16.003.06



H.320 X L.50 mm  
Art. 16.003.07



H.275 X L.55 mm  
Art. 16.003.08



H.350 X L.55 mm  
Art. 16.003.09



H.310 X L.50 mm  
Art. 16.003.10  
Forgiato / Forged



H.410 X L.70 mm  
Art. 16.003.11  
Forgiato / Forged



H.233 X L.50 mm.  
Art. 16.004 (a coppia)

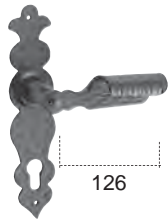

H.233 X L.50 mm.  
Art. 16.005 (a coppia)



H.268 X L.49 mm.  
Art. 16.006 (a coppia)

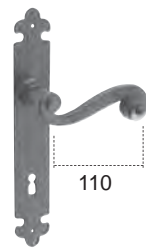

H.252 X L.38 mm.  
Art. 16.008 (a coppia)



H.268 X L.49 mm.  
Art. 16.009 (a coppia)



L.142 mm.  
Art. 16.010 (a coppia)



L.142 mm.  
Art. 16.011 (a coppia)



L.160 mm.  
Art. 16.011.01 (a coppia)

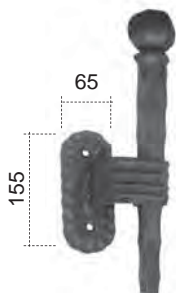

H.340 X L.100 mm.  
Art. 16.011.02 (a coppia)



H.268 X L.49 mm.  
Art. 16.012



H.250 X L.56 mm.  
Art. 16.013 (a coppia)



H.250 X L.56 mm.  
Art. 16.014

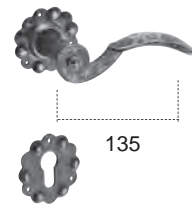

L.135 mm.  
Art. 16.015 (a coppia)

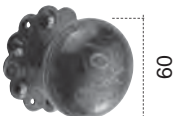

H.60 mm.  
Art. 16.016

Borchia a 1 punta



Ø 12 mm.  
Art. 16.018  
Ø 15 mm.  
Art. 16.018.01  
Ø 20 mm.  
Art. 16.018.02

Borchia a 2 punte



15 X 15 mm.  
Art. 16.019  
20 X 20 mm.  
Art. 16.019.01

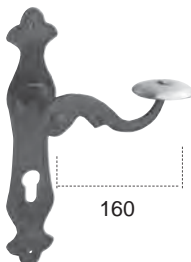

H.230 X L.50 mm.  
Art. 16.021 (a coppia)



L.110 mm.  
Art. 16.022



H.170 mm.  
Art. 16.022.01



H.90 mm.  
Art. 16.022.02

Sporgenza d'ingombro 110 mm.  
Wall protusion = 110 mm.

Tutte le parti di questo catalogo - foto comprese - sono di proprietà Euro-Fer. La riproduzione, anche parziale, è vietata in ogni forma e con ogni mezzo. / Every part of this catalogue - photos included - is Euro-Fer's property. All forms of copying are strictly prohibited.



H.165 mm.  
**Art. 16.022.03**  
Sporgenza d'ingombro 55 mm.  
Wall protusion = 55 mm.



H.200 mm.  
**Art. 16.022.04**  
Sporgenza d'ingombro 80 mm.  
Wall protusion = 80 mm.



H.80 mm.  
**Art. 16.022.05**  
Sporgenza d'ingombro 40 mm.  
Wall protusion = 40 mm.

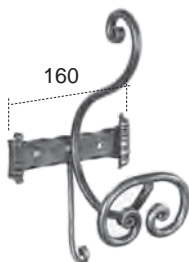

H.305 X L.160 mm.  
**Art. 16.022.06**  
Sporgenza d'ingombro 150 mm.  
Wall protusion = 150 mm.

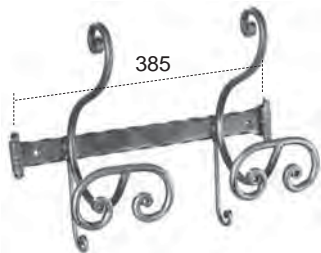

H.305 X L.385 mm.  
**Art. 16.022.07**  
Sporgenza d'ingombro 150 mm.  
Wall protusion = 150 mm.

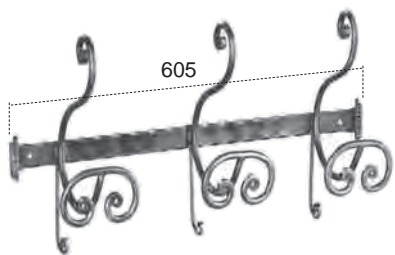

H.305 X L.605 mm.  
**Art. 16.022.08**  
Sporgenza d'ingombro 150 mm.  
Wall protusion = 150 mm.

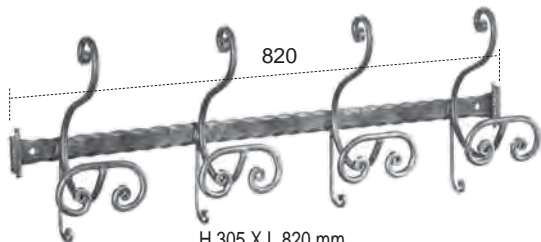

H.305 X L.820 mm.  
**Art. 16.022.09**  
Sporgenza d'ingombro 150 mm.  
Wall protusion = 150 mm.



H 1860 mm.  
**Art. 16.022.10**  
Ingombro al pavimento Ø 600 mm.  
Ingombro superiore Ø 500 mm.  
Lower dimensions = 600 mm. Ø  
Upper dimensions = 500 mm. Ø



H 1830 mm.  
**Art. 16.022.11**  
Ingombro al pavimento Ø 600 mm.  
Ingombro superiore Ø 500 mm.  
Lower dimensions = 600 mm. Ø  
Upper dimensions = 500 mm. Ø



N.	Spessore 4 mm.
0	Art. 16.022.12
1	Art. 16.022.13
2	Art. 16.022.14
3	Art. 16.022.15
4	Art. 16.022.16
5	Art. 16.022.17
6	Art. 16.022.18
7	Art. 16.022.19
8	Art. 16.022.20
9	Art. 16.022.21

Bloccaggio con 2 viti e tasselli da 10  
Locking with no. 2 size 10 screws  
and expansion bolts

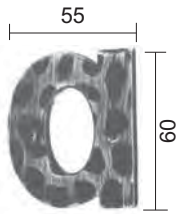

Spessore 4 mm.	
A	Art. 16.022.22
B	Art. 16.022.23
C	Art. 16.022.24
D	Art. 16.022.25

Bloccaggio con 2 viti e tasselli da 10  
Locking with no. 2 size 10 screws  
and expansion bolts

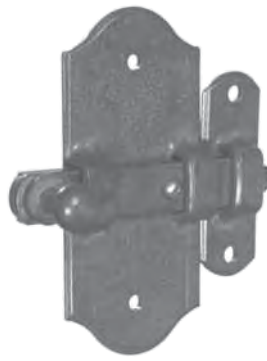

H.100 X L.85 mm.  
Profondità 40 mm.

Art. 16.022.26  
Spessore piastra d'appoggio 3 mm.  
Support plate thickness = 3 mm.



H.45 X L.250 mm.  
Profondità 40 mm.

Art. 16.022.27  
Spessore piastra d'appoggio 2 mm.  
Support plate thickness = 2 mm.



Fuori Produzione  
Out of Production

Art. 16.022.29

Ottone / Brass



H.65 X L.100 mm.

Art. 16.022.30

Fissaggio con tasselli da 10 mm.  
Fastening with size 10 expansion bolts



H.125 X L.130 mm.

Art. 16.022.31

Fissaggio con tasselli da 10 mm.  
Fastening with size 10 expansion bolts



H.70 X L.120 mm.

Art. 16.022.32

Fissaggio con tasselli da 10 mm.  
Fastening with size 10 expansion bolts



Ottone / Brass

Ø 120 Profondità 40 mm.

Art. 16.022.33

Fissaggio con barra filettata MA 6  
Fastening with MA 6 threaded bar

Ø 140 Profondità 40 mm.

Art. 16.022.34

Fissaggio con barra filettata MA 6  
Fastening with MA 6 threaded bar

Elementi in ottone / Knockers and Handles



H 140 Profondità 40 mm.

Art. 16.022.35

Fissaggio con barra filettata MA 6  
Fastening with MA 6 threaded bar



Fuori Produzione  
Out of Production

Art. 16.022.36

Elementi in ottone / Knockers and Handles



H 200 Profondità 60 mm.

Art. 16.022.39

Fissaggio con barra filettata MA 6  
Fastening with MA 6 threaded bar



H 200 Profondità 60 mm.

Art. 16.022.41

Fissaggio con barra filettata MA 6  
Fastening with MA 6 threaded bar

H 250 Profondità 60 mm.

Art. 16.022.40

Fissaggio con barra filettata MA 6  
Fastening with MA 6 threaded bar

H 250 Profondità 60 mm.

Art. 16.022.42

Fissaggio con barra filettata MA 6  
Fastening with MA 6 threaded bar



H. 140 x L.140 mm

Art. 16.022.43

H. 100 x L.100 mm

Art. 16.022.44

H. 55 x L.55 mm

Art. 16.022.45

Fissaggio con barra filettata MA6 / Fastening with MA6 threaded bar





Venduti in coppia  
*Sold in pairs*



H.330 X L.420 mm.  
Art. 16.023

Venduti in coppia  
*Sold in pairs*

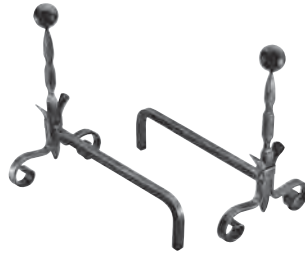

H.400 X L.420 mm.  
Art. 16.025

Venduti in coppia  
*Sold in pairs*



H.460 X L.420 mm.  
Art. 16.027



H.630 mm.  
Art. 16.024



H.600 mm.  
Art. 16.026

Venduti in coppia  
*Sold in pairs*



H.460 X L.610 mm.  
Art. 16.028.01

Venduti in coppia  
*Sold in pairs*



H.465 X L.530 mm.  
Art. 16.028.03



H.870 X L.375 mm.  
Art. 16.028.02



H.750 X L.360 mm.  
Art. 16.028.05



H.500 X L.1000 mm.  
Art. 16.029



H.500 X L.900 mm.  
Art. 16.030



H.480 X L.700 mm.  
Art. 16.032



H.510 X L.1000 mm.  
Art. 16.032.02  
Profondità appoggio 180 mm.  
Support depth = 180 mm.



Fuori Produzione  
Out of Production

Art. 16.032.03



H.520 X L.745 mm.  
Art. 16.032.04  
Profondità appoggio 180 mm.  
Support depth = 180 mm.



H.180 X L.400 mm.  
**Art. 16.033**  
Profondità appoggio 300 mm.  
Support depth = 300 mm.



H.410 X L.260 mm.  
Sporgenza d'ingombro 90 mm.  
Wall protrusion = 90 mm

- Art. 16.034** Rosso / Red  
**Art. 16.036** Metallizzato / Metallized  
**Art. 16.037** Verde / Green  
**Art. 16.038** Grigio ghisa / Cast iron grey  
**Art. 16.039** Nero / Black



H.465 X L.298 mm.  
Sporgenza d'ingombro 96 mm.  
Wall protrusion = 96 mm

- Art. 16.040** Rosso / Red  
**Art. 16.041** Bordeaux / Red-Wine  
**Art. 16.042** Metallizzato / Metallized



H.360 X L.275 mm.  
**Art. 16.045.01**  
Sporgenza d'ingombro 115 mm.  
Wall protrusion = 115 mm



H.410 X L. 250 mm.  
**Art. 16.045.03** rosso / red  
**Art. 16.045.04** verde / red  
Sporgenza d'ingombro 100 mm.  
Wall protrusion 100 mm.



- Art. 16.046** Patina Oro / Gold Patina 0,2 lt.  
**Art. 16.047** Patina Rame / Copper Patina 0,2 lt.  
**Art. 16.049** Patina Argento / Silver Patina 0,2 lt.

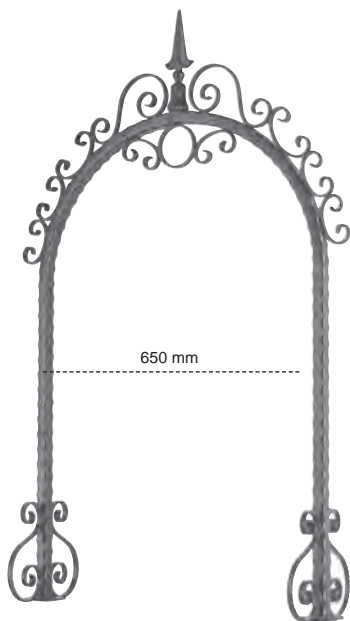

650 mm

Martellato / *Hammered*  
Art. 16.120

H 1340 X L.810 mm

Tubo □ 30 mm

Ricci Modello Scala / *Scala Model Scrolls*  
≠ 14 X 6 mm



H. 280 x L.285 mm

Colore / *Colour*

Art. 16.151 Grigio / *Grey*



base 90 X H.135 mm.

Art. 16.150

Portacandele  
*Candle holder*



H. 330 x L.465 mm

Colore / *Colour*

Art. 16.152 Grigio / *Grey*

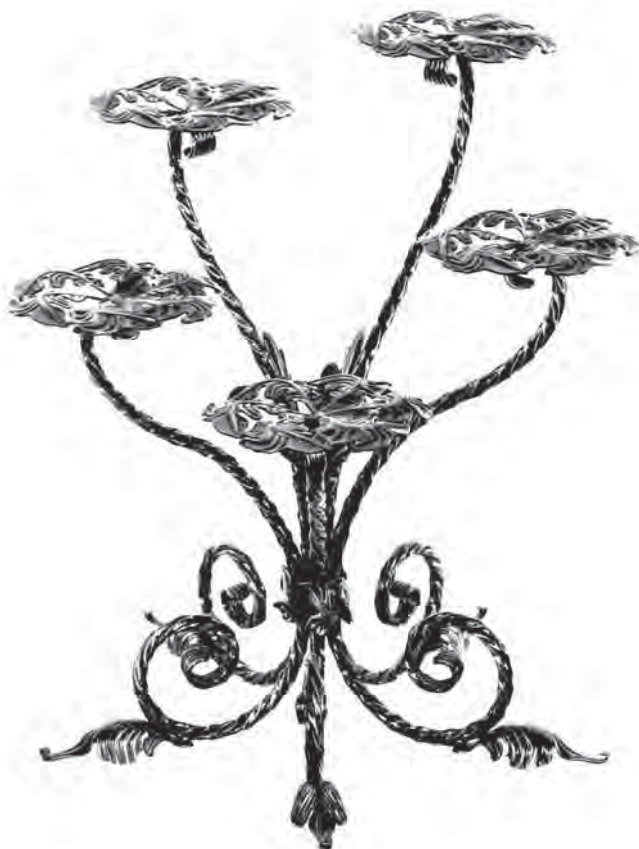

H. 730 x L.680 mm

Colore / *Colour*

Art. 16.160 Grigio / *Grey*

Art. 16.160.01 Rame / *Copper*



H. 1100 x L.500 mm

Colore / *Colour*

Art. 16.161 Grigio / *Grey*

Art. 16.162 Rame / *Copper*



## Finali per tubo tenda / Ends for curtain tube



H.150 X L.50 mm - Base Ø 20 mm  
**Art. 16.105** nero / black



H.240 X L.55 mm - Base Ø 20 mm  
**Art. 16.106** nero / black



H.205 X L.35 mm - Base Ø 20 mm  
**Art. 16.107** nero / black

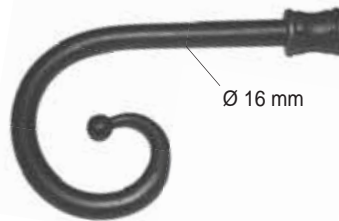

H.215 X L.125 mm - Base Ø 20 mm  
**Art. 16.108** nero / black

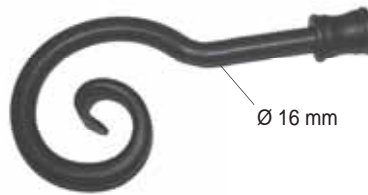

H.235 X L.110 mm - Base Ø 20 mm  
**Art. 16.109** nero / black

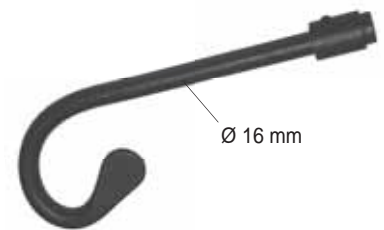

Ferma tenda / Curtain holder

H.210 X 80 mm  
**Art. 16.110** nero / black

## Tubo per tenda / Curtain tube



L.2000 - Ø 20 mm  
**Art. 16.115** nero / black

L.3000 - Ø 20 mm  
**Art. 16.116** nero / black

## Anelli tenda / Curtain rings

Gancetto non fornito / Hook not supplied

pz. 20  
Diam. 40 mm  
**Art. 16.111** nero / black



Ø esterno / out 40 mm  
Ø interno / in 32 mm

Ø 4 mm

## Fissaggio per supporto tubo / Wall fixing for tube support



Ø esterno / out 67 mm  
Ø interno / in 17 mm

**Art. 16.113C** nero / black



**Art. 16.113F**

## Supporto a parete per tubo / Wall support for tube



Per tubo / For tube - Ø 20 mm  
**Art. 16.112** nero / black

## Supporto a sbalzo per tubo / Cantilever support for tube



L. 175 X 35 mm.  
Per tubo / For tube - Ø 20 mm  
**Art. 16.113** nero / black

Installazione con supporto a sbalzo + finali per tubo / Installation with cantilever support + ends for curtain tube

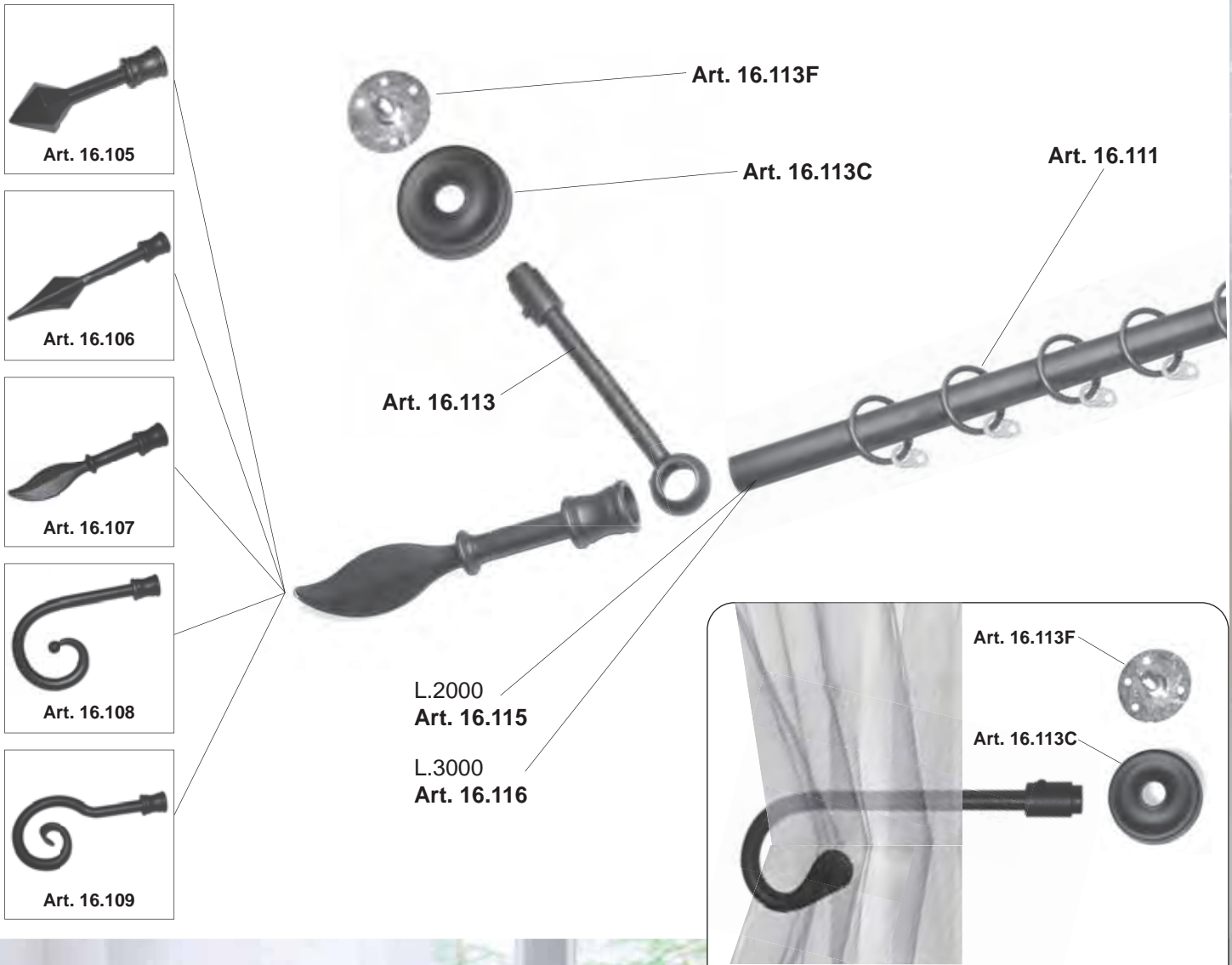

Installazione con supporto a parete per tubo  
Installation with wall support for tube

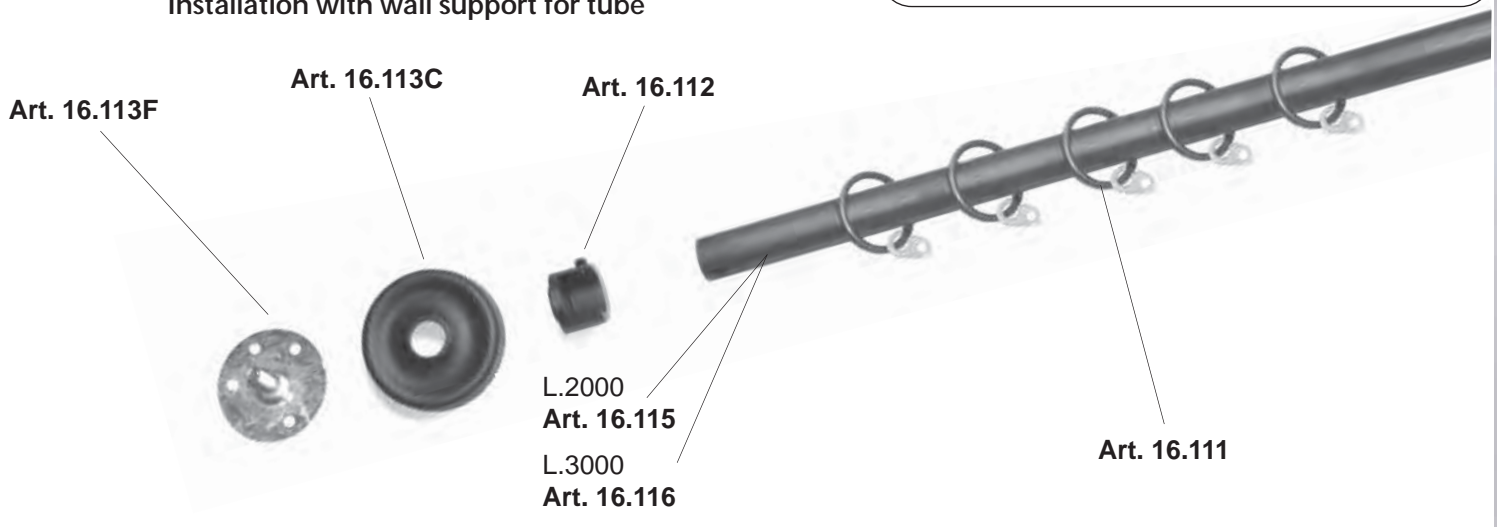



Nero / Black  
Art. 16.200 H.1000 X L.900 mm.



Nero / Black  
Art. 16.201 H.1000 X L.900 mm.



Nero / Black  
Art. 16.203 H.1000 X L.900 mm.



Nero / Black  
Art. 16.204 H.1000 X L.900 mm.

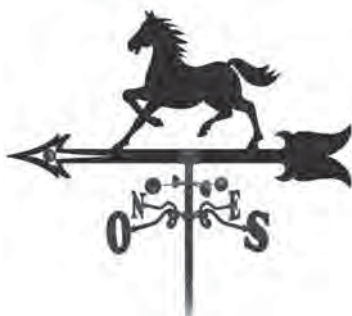

Nero / Black  
Art. 16.205 H.1000 X L.900 mm.



Nero / Black  
Art. 16.206 H.1000 X L.900 mm.



Nero / Black  
Art. 16.207 H.1000 X L.900 mm.



Nero / Black  
Art. 16.208 H.1000 X L.900 mm.

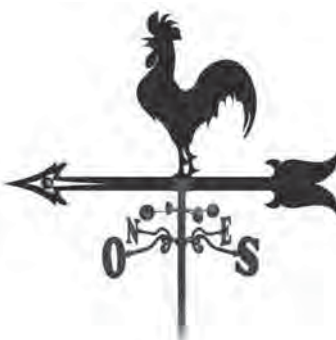

Nero / Black  
Art. 16.209 H.1000 X L.900 mm.



Nero / Black  
Art. 16.210 H.1000 X L.900 mm.



Nero / Black  
Art. 16.212 H.1000 X L.900 mm.



Nero / Black  
Art. 16.280  
Base di supporto per segnamento  
Fixing support



Nero / Black  
Art. 16.284  
Base di supporto a parete per segnamento  
Walls support



Art. 16.285  
Bussola per regolazione segnamento  
Compass



1. Avvitare i punti cardinali con un cacciavite. Fare attenzione che le lettere siano nella giusta posizione.
  2. Collocare l'anemometro sull'asta.
  3. Introdurre la parte superiore del segna vento sull'asta ed avvitarla fino in fondo con un cacciavite.
- 
1. Screw the cardinal points through a screwdriver. Check that the letters are in the right position.
  2. Place the anemometer on the rod.
  3. Insert the upper part of the weather vanes in the rod and screw it in through a screwdriver.

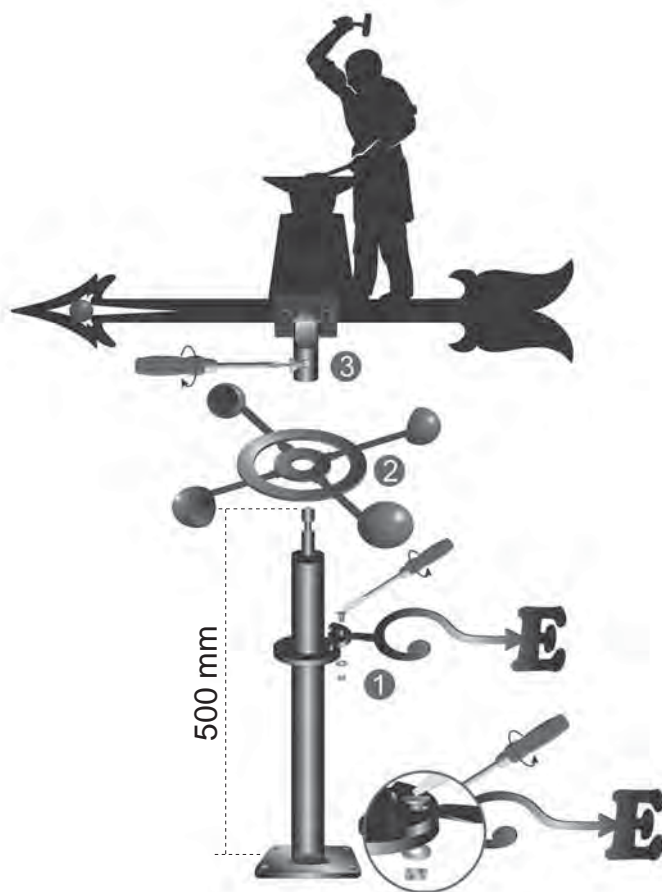

**Istruzioni:**

1. Nel collocare il supporto di fissaggio regolabile o quello da parete, bisogna tener presente che la parte piana dove si fisserà il palo del segnavento deve essere perfettamente a livello.
2. Una volta fissato il supporto, avvitare il palo completamente montato tramite le 4 viti, senza però fissarle del tutto. Orientare quindi il segnavento servendosi della bussola (in tutte le bussole la freccia segna il nord magnetico). Con il braccio della lettera "N" rivolto verso nord, fissare con forza le viti.

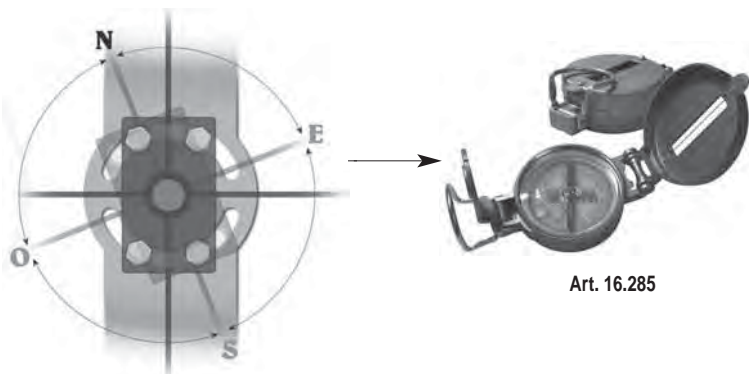

Art. 16.285

**Instructions:**

1. Either if you are placing the adjustable fixing support, or the walls one, you will need to consider that the flat surface where you place the pole of the weather vanes needs to be completely level.
2. Once the support has been fixed, screw the mounted pole using the 4 screws, but leave them slightly unscrewed then, orient the weather vanes through the compass (all compasses have the arrow pointing at the magnetic north) and with the compass arm of letter "N" pointing at the north, finally screw the screws completely to the end.

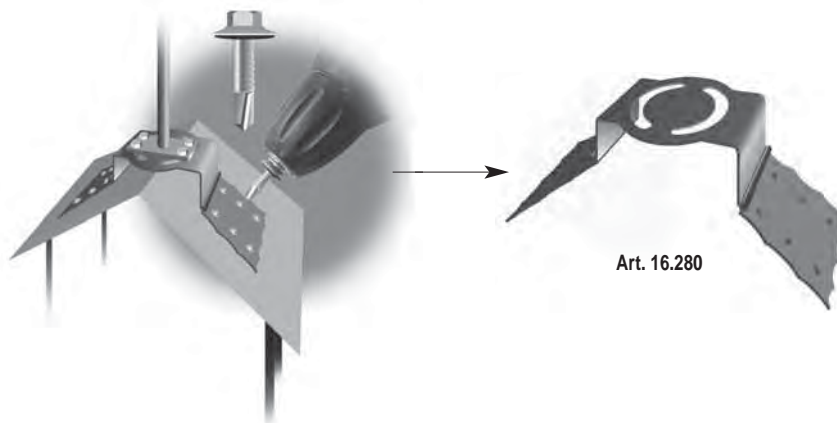

Art. 16.280

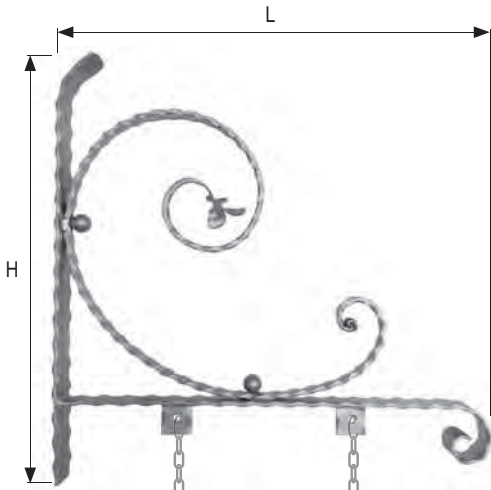

H. 550 x L. 570 mm  
Art. 16.300  
≠ 40x6  
riccio / scroll ≠ 16x8

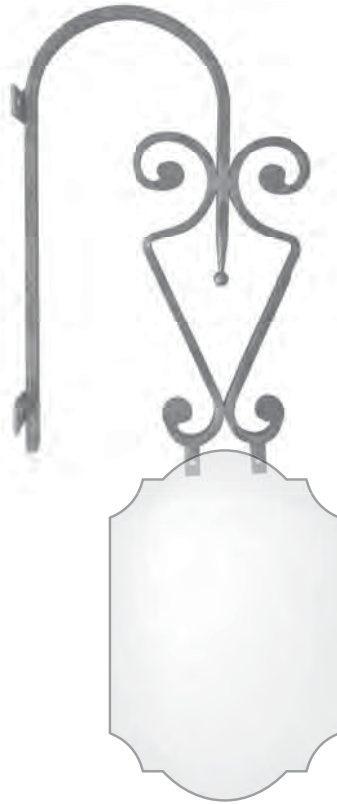

H. 500 x L. 300 mm  
Art. 16.301  
paletto / stake □ 12  
riccio / scroll □ 10



H. 650 x L. 870 mm  
Art. 16.302  
≠ 35x10 liscio / smooth  
riccio / scroll ≠ 16x6  
modello scala / scala model

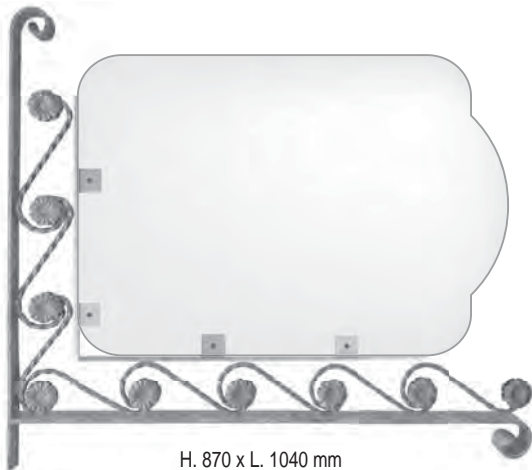

H. 870 x L. 1040 mm  
Art. 16.303  
≠ 35x10 liscio / smooth  
riccio / scroll □ 10 attorcigliato / twisted  
🌸 fiori su entrambi i lati / flowers on booth sides

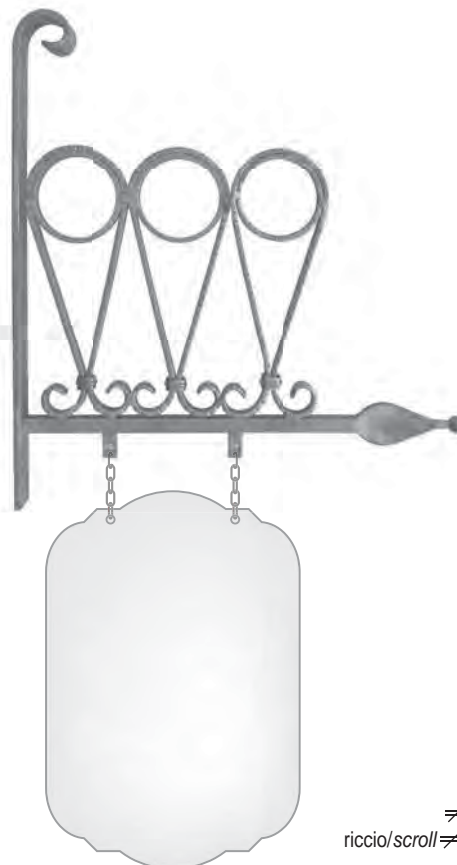

H. 660 x L. 510 mm  
Art. 16.304  
≠ 35x10 liscio / smooth  
riccio / scroll ≠ 16x8  
liscio / smooth

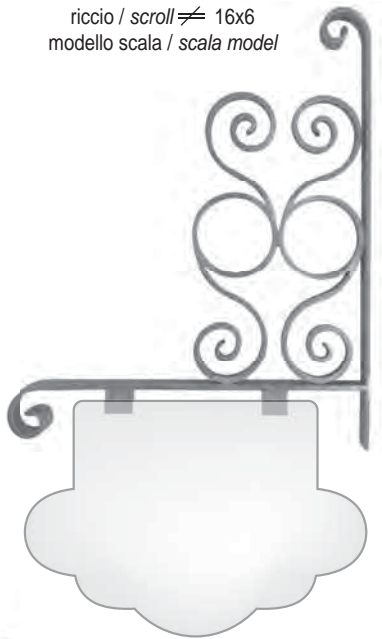

H. 550 x L. 510 mm  
Art. 16.305  
≠ 35x10 liscio/smooth  
riccio/scroll ≠ 14x6 modello scala / scala model  
paletto / stake □ 16



Le insegne sono realizzate con taglio laser, personalizzate con logo o nome dell'attività.

The signs are made with laser cutting, customized with logo or business name.

H. 500 x L. 570 mm  
**Art. 16.306**  
 ≠ 35x10 liscio / smooth  
 riccio/scroll ≠ 12x6 liscio / smooth

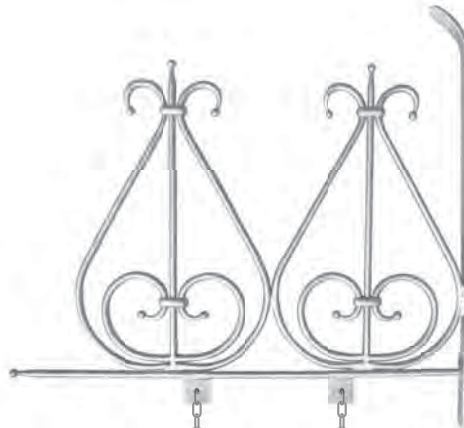

H. 710 x L. 640 mm  
**Art. 16.307**  
 ≠ 35x10 liscio / smooth  
 riccio / scroll Ø 12

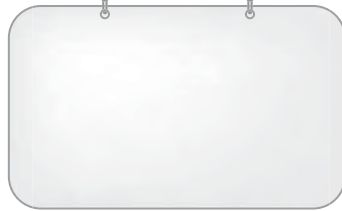

H. 680 x L. 570 mm  
**Art. 16.308**  
 ≠ 35x10 liscio / smooth  
 rosone / rosette □ 12



H. 560 x L. 560 mm  
**Art. 16.309**  
 ≠ 35x10 liscio / smooth  
 rosone / rosette ≠ 12x6



H.460 x L. 770 mm  
**Art. 16.310**  
 ≠ 35x10 liscio / smooth  
 rosone / rosette Ø 10



H. 560 x L. 580 mm  
**Art. 16.311**  
 ≠ 35x10 liscio / smooth  
 riccio / scroll □ 10

Le insegne sono realizzate con taglio laser, personalizzate con logo o nome dell'attività.

The signs are made with laser cutting, customized with logo or business name.



**COMPONENTI IN GHISA  
ELEMENTS IN CAST IRON**



Ferro fuso / Cast steel  
H.65 x L.40 mm

Art. CS.13.142 □ 12,5



Ferro fuso / Cast steel  
H.67 x L.45 mm

Art. CS.13.151 □ 12,5  
Art. CS.13.152 □ 14,5  
Art. CS.13.153 □ 16,5



Ferro fuso / Cast steel  
H.38 x L.40 mm

Art. CS.13.900 □ 14,5  
Art. CS.13.900.01 □ 16,5  
Art. CS.13.900.02 □ 12,5



Ferro fuso / Cast steel  
H.65 x L.40 mm

Art. CS.13.901 □ 14,5  
Art. CS.13.901.01 □ 16,5  
Art. CS.13.901.02 □ 12,5



Ghisa / Cast iron  
H.45 x L.40 mm

Art. CI.13.902 □ 12,5  
Art. CI.13.903 □ 14,5

**ARTICOLI ZINCATI A FREDDO  
COLD GALVANIZED ARTICLES**

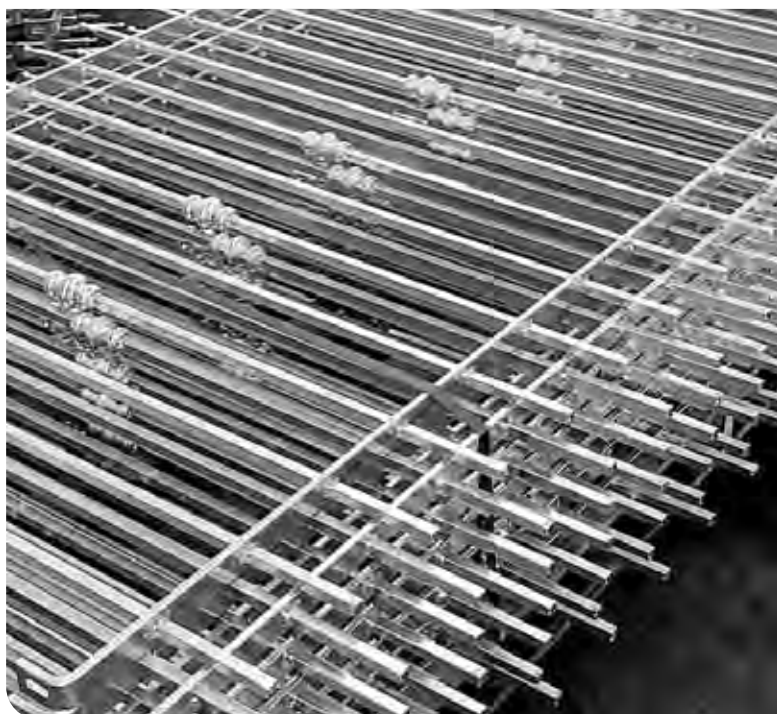



Liscio / Smooth  
H.115 X L.75 mm  
Art. 01.094.01.ZF ≠ 14 x 6 mm



Tondo / Round  
H.350 X L.150 mm.  
Art. 01.369.ZF Ø 14  
Art. 01.370.ZF Ø 16

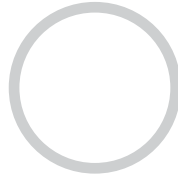

Liscio / Smooth  
H.100 mm  
Art. 02.031.ZF ≠ 12 x 6 mm



Liscio / Smooth  
H.1500 mm  
Art. 04.106.15.ZF Ø 14 mm  
H.1500 mm  
Art. 04.106.19.ZF Ø 16 mm



FORO QUADRO  
SQUARE HOLE



FORO TONDO  
ROUND HOLE



FORO QUADRO  
SQUARE HOLE

H.2000 mm.  
Art. 08.001.ZF fori / hole □ 14 INT.140 mm - n°14 fori / holes  
Art. 08.002.ZF fori / hole □ 16 INT.150 mm - n°13 fori / holes  
Art. 08.006.01.ZF fori / hole □ 12 INT.120 mm - n°16 fori / holes

H.2000 mm.  
Art. 08.023.ZF fori / hole Ø 14 INT.140 mm - n°14 fori / holes  
Art. 08.024.ZF fori / hole Ø 16 INT.150 mm - n°13 fori / holes  
Art. 08.025.ZF fori / hole Ø 18 INT.160 mm - n°12 fori / holes  
Art. 08.029.01.ZF fori / hole Ø 12 INT.120 mm - n°16 fori / holes  
Art. 08.115.ZF fori / hole Ø 14 INT.125 mm - n°15 fori / holes  
Art. 08.116.ZF fori / hole Ø 16 INT.125 mm - n°15 fori / holes

INT.125  
15 Fori per barra  
15 Holes for bar  
H.2000 mm. Foro □ 12  
Art. 08.059.ZF ≠ 30 x 8  
Art. 08.063.ZF ≠ 40 x 8



Piatto Mezzo Tondo /  
Half-Round Flat  
H.6000 mm.

Art. 12.059.01.ZF ≠ 30x8  
Art. 12.063.01.ZF ≠ 40x8  
Art. 12.064.01.ZF ≠ 40x10  
Art. 12.066.01.ZF ≠ 50x10

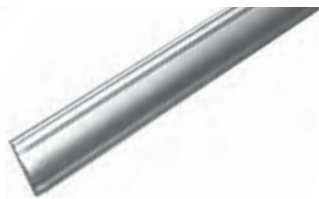

Sagomato / Contoured  
H.6000 mm.

Art. 12.085.ZF ≠ 50 x 14  
Art. 12.085.01.ZF ≠ 40 x 12  
Art. 12.085.02.ZF ≠ 45 x 12  
Art. 12.085.03.ZF ≠ 60 x 12 NEW



Barra per Fascette / Collar Bars  
H.4000 mm.

Art. 12.118.ZF ≠ 14x4

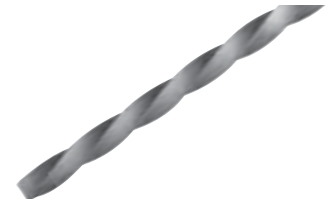

H.6000 mm.

Art. 12.158.ZF □ 12x12 mm.  
Art. 12.159.ZF □ 14x14 mm.



Quadro Martellato /  
Hammered Square  
H.6000 mm.

Art. 12.182.ZF □ 12x12 mm.  
Art. 12.183.ZF □ 14x14 mm.



Tubo Martellato /  
Tube Hammered  
H.6000 mm.

Art. 12.238.ZF □ 40x40 x 2.5 mm.  
Art. 12.240.ZF □ 30x30 x 2.5 mm.



H.125 X L.60 mm.  
Art. 13.077.ZF Ø 32 mm



H.155 X L.65 mm.  
Art. 13.080.ZF Ø 16 mm



## Nuove Borchie in Tubo / New Studs in Tube



H.39 x L.49 mm.

Art. 13.135.ZF Ø 12,5 mm  
Art. 13.136.ZF Ø 14,5 mm  
Art. 13.137.ZF Ø 16,5 mm



H.67 x L.40 mm.

Art. 13.138.ZF Ø 12,5 mm  
Art. 13.139.ZF Ø 14,5 mm  
Art. 13.140.ZF Ø 16,5 mm



Borchie Svasate /  
Countersunk Ironstud  
H.39 X L.40 mm.

Art. 13.137.B.ZF Ø 16,5 mm



H.67 x L. 40 mm

Art. TB.13.139.ZF Ø 14,5  
Art. TB.13.140.ZF Ø 16,5



H.67 x L.40 mm.

Art. 13.142.ZF □ 12,5 mm

H.67 x L.45 mm.

Art. 13.152.ZF □ 14,5 mm

H.36 x L.37 mm.  
Art. 13.135.E.ZF Ø 12,5 mm  
Art. 13.136.E.ZF Ø 14,5 mm  
Art. 13.137.E.ZF Ø 16,5 mm

H.63 x L.37 mm.  
Art. 13.138.E.ZF Ø 12,5 mm  
Art. 13.139.E.ZF Ø 14,5 mm  
Art. 13.140.E.ZF Ø 16,5 mm



H.67 X L.45 mm.

Art. 13.148.ZF Ø 16,5 mm



H.25 x L.35 mm.

Art. 13.167.ZF Ø 12,5 mm  
Art. 13.167.02.ZF Ø 16,5 mm

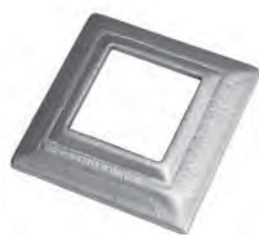

H.80 x 80 H. 20 mm.

Art. 13.319.ZF foro □ 30,5 mm  
Art. 13.320.ZF foro □ 35,5 mm  
Art. 13.321.ZF foro □ 40,5 mm

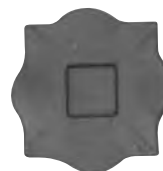

□ 100x100 mm

Art. 13.311.ZF  
sede/seat □ 30x30 mm



□ 100x100 mm

Art. 13.313.ZF  
foro/hole □ 30x30 mm

H.60 x 60 H. 20 mm.  
Art. 13.322.ZF foro □ 25,5 mm  
Art. 13.323.ZF foro □ 30,5 mm



Ferro fuso / Cast steel  
H.38 x L.40 mm

Art. CS.13.900.ZF □ 14,5



Ferro fuso / Cast steel  
H.65 x L.40 mm

Art. CS.13.901.ZF □ 14,5  
Art. CS.13.901.01.ZF □ 16,5



### Copricolonna / Post Caps

Art. 15.052.ZF □ 30x30 mm  
Art. 15.053.ZF □ 40x40 mm  
Art. 15.054.ZF □ 50x50 mm  
Art. 15.055.ZF □ 60x60 mm

### Copricolonna / Post Caps

Art. 15.056.ZF □ 80x80 mm  
Art. 15.057.ZF □ 100x100 mm  
Art. 15.058.ZF □ 120x120 mm  
Art. 15.059.ZF □ 150x150 mm

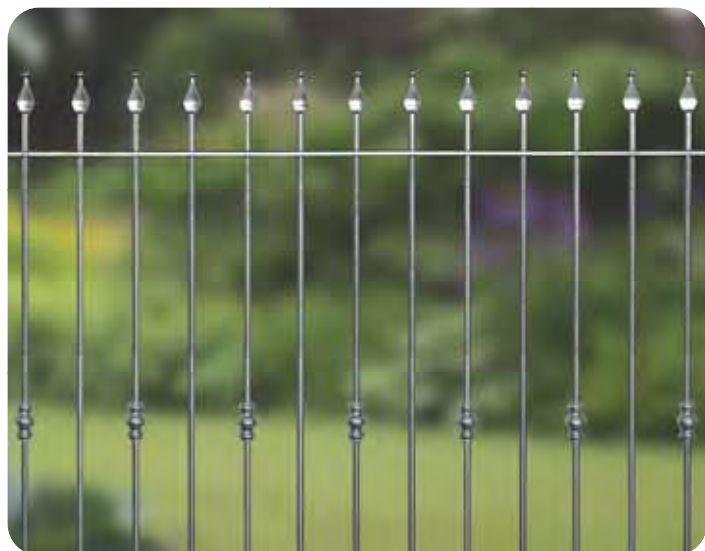

### Sfera vuota / Hollow sphere

Art. 15.059.05.ZF □ 30x30 Ø 40 mm  
Art. 15.059.06.ZF □ 40x40 Ø 40 mm  
Art. 15.059.07.ZF □ 50x50 Ø 50 mm

### Sfera vuota / Hollow sphere

Art. 15.059.08.ZF □ 60x60 Ø 60 mm  
Art. 15.059.09.ZF □ 80x80 Ø 80 mm  
Art. 15.059.10.ZF □ 100x100 Ø 100 mm



*Liscio / Smooth*

**Tondo.ZF.** 6x6000 mm  
**Tondo.ZF.** 8x6000 mm  
**Tondo.ZF.** 10x6000 mm  
**Tondo.ZF.** 12x6000 mm

*Liscio / Smooth*

**Tondo.ZF.** 14x6000 mm  
**Tondo.ZF.** 16x6000 mm  
**Tondo.ZF.** 18x6000 mm  
**Tondo.ZF.** 20x6000 mm

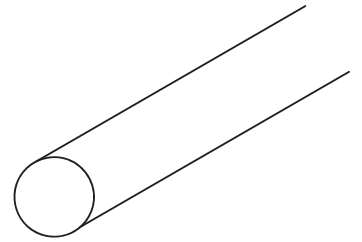
*Liscio / Smooth*  
H.6000 mm.

**Piatto.ZF** ≠ 20 x 3  
**Piatto.ZF** ≠ 20 x 4  
**Piatto.ZF** ≠ 20 x 5  
**Piatto.ZF** ≠ 20 x 10  
**Piatto.ZF** ≠ 25 x 3  
**Piatto.ZF** ≠ 25 x 4  
**Piatto.ZF** ≠ 25 x 5

*Liscio / Smooth*  
H.6000 mm.

**Piatto.ZF** ≠ 30 x 3  
**Piatto.ZF** ≠ 30 x 4  
**Piatto.ZF** ≠ 30 x 5  
**Piatto.ZF** ≠ 30 x 6  
**Piatto.ZF** ≠ 30 x 8  
**Piatto.ZF** ≠ 30 x 10  
**Piatto.ZF** ≠ 30 x 20

*Liscio / Smooth*  
H.6000 mm.

**Piatto.ZF** ≠ 40 x 4  
**Piatto.ZF** ≠ 40 x 5  
**Piatto.ZF** ≠ 40 x 8  
**Piatto.ZF** ≠ 40 x 10  
**Piatto.ZF** ≠ 50 x 5  
**Piatto.ZF** ≠ 50 x 8  
**Piatto.ZF** ≠ 50 x 10  
**Piatto.ZF** ≠ 60 x 5

*Liscio / Smooth*  
H.6000 mm.

**Piatto.ZF** ≠ 80 x 5  
**Piatto.ZF** ≠ 100 x 5 **NEW**

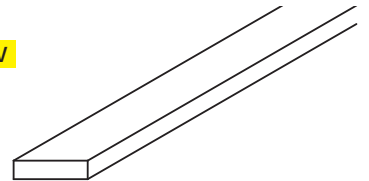
*Liscio / Smooth*  
H.6000 mm.

**Angolare.ZF** □ 20 x 20 x 3  
**Angolare.ZF** □ 25 x 25 x 4  
**Angolare.ZF** □ 30 x 30 x 3  
**Angolare.ZF** □ 30 x 30 x 5  
**Angolare.ZF** □ 35 x 35 x 5

*Liscio / Smooth*  
H.6000 mm.

**Angolare.ZF** □ 40 x 40 x 5  
**Angolare.ZF** □ 45 x 45 x 5  
**Angolare.ZF** □ 50 x 50 x 5  
**Angolare.ZF** □ 60 x 60 x 5

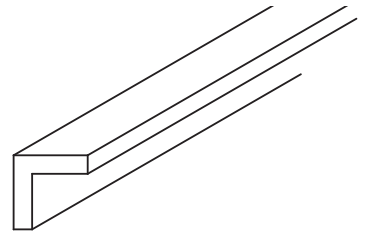
*Liscio / Smooth*  
H.6000 mm.

**Profilo.ZF** T 30 x 30 x 4  
**Profilo.ZF** T 35 x 35 x 4,5  
**Profilo.ZF** T 40 x 40 x 5  
**Profilo.ZF** T 50 x 50 x 6

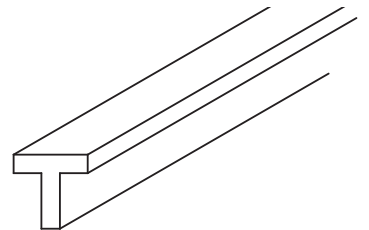
*Liscio / Smooth*

**Quadro.ZF** □ 14x6000 mm  
**Quadro.ZF** □ 16x6000 mm

*Liscio / Smooth*

**Quadro.ZF** □ 10x6000 mm  
**Quadro.ZF** □ 12x6000 mm  
**Quadro.ZF** □ 20x6000 mm

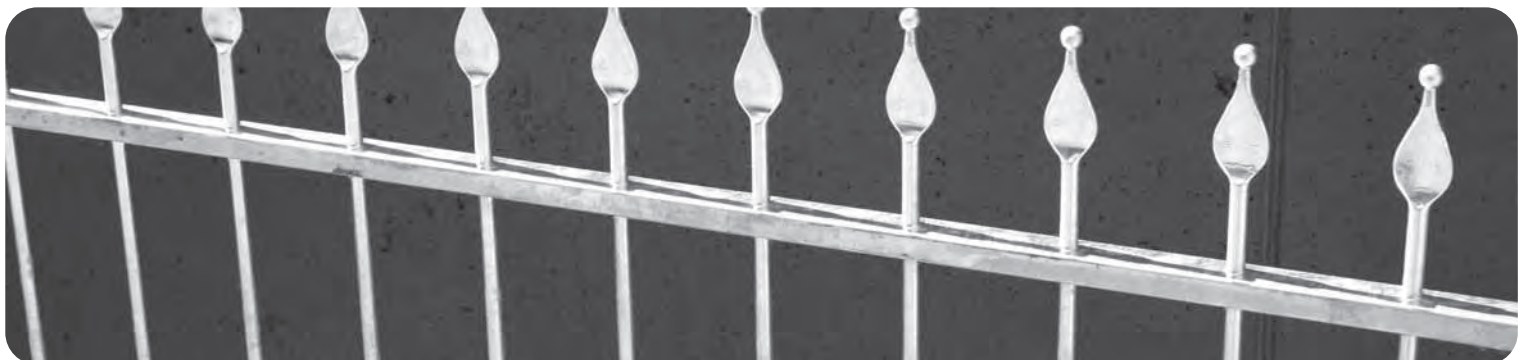
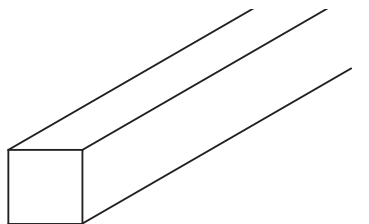

<b>Art. LB1000X2000.20/10.ZF</b>	Lamiera Bugnata / <i>Teardrop patterned steel sheet</i> 1000x2000mm sp. 20/10
<b>Art. LB1000X2000.25/10.ZF</b>	Lamiera Bugnata / <i>Teardrop patterned steel sheet</i> 1000x2000mm sp. 25/10
<b>Art. LB1000X2000.30/10.ZF</b>	Lamiera Bugnata / <i>Teardrop patterned steel sheet</i> 1000x2000mm sp. 30/10
<b>Art. LB1250X2500.20/10.ZF</b>	Lamiera Bugnata / <i>Teardrop patterned steel sheet</i> 1250x2500mm sp. 20/10
<b>Art. LB1250X2500.25/10.ZF</b>	Lamiera Bugnata / <i>Teardrop patterned steel sheet</i> 1250x2500mm sp. 25/10
<b>Art. LB1250X2500.30/10.ZF</b>	Lamiera Bugnata / <i>Teardrop patterned steel sheet</i> 1250x2500mm sp. 30/10
<b>Art. LB1500X3000.25/10.ZF</b>	Lamiera Bugnata / <i>Teardrop patterned steel sheet</i> 1500x3000mm sp. 25/10
<b>Art. LB1500X3000.30/10.ZF</b>	Lamiera Bugnata / <i>Teardrop patterned steel sheet</i> 1500x3000mm sp. 30/10

*A seconda delle diponibilita' del magazzino la bugna puo' essere tronca oppure affusolata  
Depending on the availability of the warehouse the drop could be truncated or tapered*

Lamiera Bugnata Tronca /  
*Teardrop patterned steel sheet (truncated drop)*



Lamiera Bugnata Affusolata /  
*Teardrop patterned steel sheet (tapered drop)*

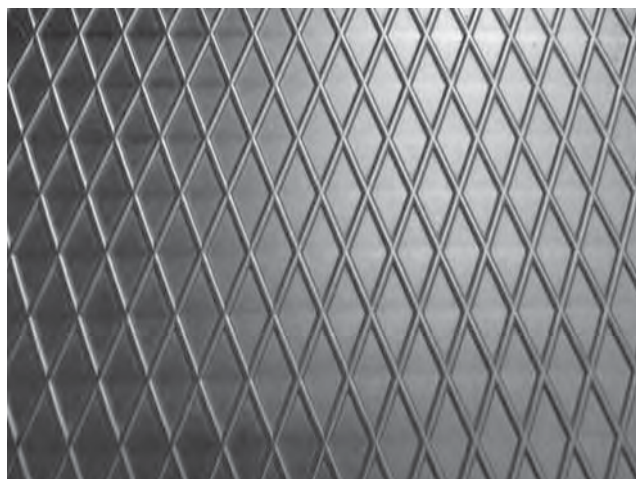

**Art. LS1000X2000.30/10.ZF**  
Lamiera Striata / *Diamond patterned steel sheet*  
1000x2000mm sp. 30/10

**Art. LS1250X2500.30/10.ZF**  
Lamiera Striata / *Diamond patterned steel sheet*  
1250x2500mm sp. 30/10



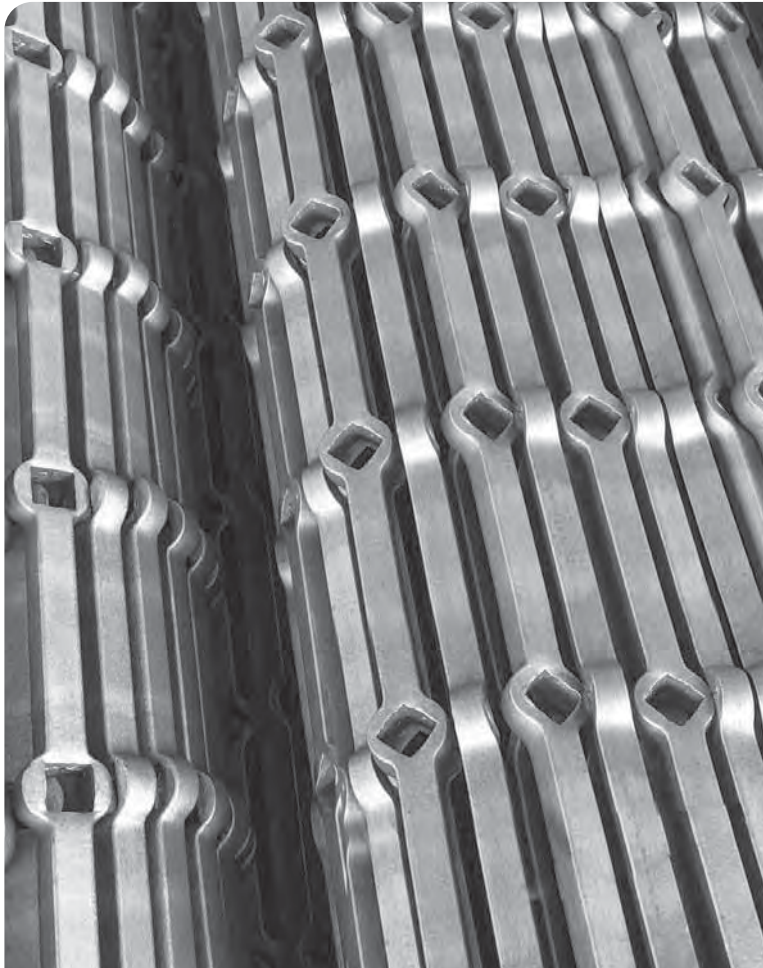

Tutte le parti di questo catalogo - foto comprese - sono di proprietà Euro-Fer. La riproduzione, anche parziale, è vietata in ogni forma e con ogni mezzo. / Every part of this catalogue - photos included - is Euro-Fer's property. All forms of copying are strictly prohibited.





sezione ferro iron section	tipo ferro iron type	codice code	interasse centre distance	nr. fori nr. of holes	tipo fori kind of holes	luce hole to hole	trattamento finishing
■ 14x14	liscio / smooth	<b>08.001</b>	140 mm	14 fori / holes	□ 14x14	126 mm	grezzo / raw
■ 16x16	liscio / smooth	<b>08.002</b>	150 mm	13 fori / holes	□ 16x16	134 mm	grezzo / raw
■ 18x18	liscio / smooth	<b>08.003</b>	160 mm	12 fori / holes	□ 18x18	142 mm	grezzo / raw
■ 20x20	liscio / smooth	<b>08.004</b>	170 mm	11 fori / holes	□ 20x20	150 mm	grezzo / raw
■ 22x22	liscio / smooth	<b>08.005</b>	170 mm	11 fori / holes	□ 22x22	148 mm	grezzo / raw
■ 25x25	liscio / smooth	<b>08.006</b>	180 mm	10 fori / holes	□ 25x25	155 mm	grezzo / raw
■ 12x12	liscio / smooth	<b>08.006.01</b>	120 mm	16 fori / holes	□ 12x12	108 mm	grezzo / raw



■ 14x14	liscio / smooth	<b>08.007</b>	140 mm	14 fori / holes	◇ 14x14 sullo spigolo / on the edge	120 mm	grezzo / raw
■ 16x16	liscio / smooth	<b>08.008</b>	150 mm	13 fori / holes	◇ 16x16 sullo spigolo / on the edge	127 mm	grezzo / raw
■ 18x18	liscio / smooth	<b>08.009</b>	160 mm	12 fori / holes	◇ 18x18 sullo spigolo / on the edge	135 mm	grezzo / raw
■ 20x20	liscio / smooth	<b>08.010</b>	170 mm	11 fori / holes	◇ 20x20 sullo spigolo / on the edge	142 mm	grezzo / raw
■ 22x22	liscio / smooth	<b>08.011</b>	170 mm	11 fori / holes	◇ 22x22 sullo spigolo / on the edge	139 mm	grezzo / raw
■ 25x25	liscio / smooth	<b>08.012</b>	180 mm	10 fori / holes	◇ 25x25 sullo spigolo / on the edge	145 mm	grezzo / raw



■ 14x14	liscio / smooth	<b>08.013</b>	140 mm	14 fori / holes	◇ 14x14	120 mm	grezzo / raw
■ 16x16	liscio / smooth	<b>08.014</b>	150 mm	13 fori / holes	◇ 16x16	127 mm	grezzo / raw
■ 18x18	liscio / smooth	<b>08.015</b>	160 mm	12 fori / holes	◇ 18x18	135 mm	grezzo / raw
■ 20x20	liscio / smooth	<b>08.016</b>	170 mm	11 fori / holes	◇ 20x20	142 mm	grezzo / raw
■ 22x22	liscio / smooth	<b>08.017</b>	170 mm	11 fori / holes	◇ 22x22	139 mm	grezzo / raw
■ 25x25	liscio / smooth	<b>08.018</b>	180 mm	10 fori / holes	◇ 25x25	145 mm	grezzo / raw



Ø 14	liscio / smooth	<b>08.019</b>	140 mm	14 fori / holes	θ 14x26 mm ovale / oval		grezzo / raw
Ø 16	liscio / smooth	<b>08.020</b>	150 mm	13 fori / holes	θ 16x28 mm ovale / oval		grezzo / raw
Ø 18	liscio / smooth	<b>08.021</b>	160 mm	12 fori / holes	θ 18x30 mm ovale / oval		grezzo / raw
Ø 20	liscio / smooth	<b>08.022</b>	170 mm	11 fori / holes	θ 20x33 mm ovale / oval		grezzo / raw



Ø 14	liscio / smooth	<b>08.023</b>	140 mm	14 fori / holes	Ø 14	126 mm	grezzo / raw
Ø 16	liscio / smooth	<b>08.024</b>	150 mm	13 fori / holes	Ø 16	126 mm	grezzo / raw
Ø 18	liscio / smooth	<b>08.025</b>	160 mm	12 fori / holes	Ø 18	142 mm	grezzo / raw
Ø 20	liscio / smooth	<b>08.026</b>	170 mm	11 fori / holes	Ø 20	150 mm	grezzo / raw
Ø 22	liscio / smooth	<b>08.027</b>	170 mm	11 fori / holes	Ø 22	148 mm	grezzo / raw
Ø 25	liscio / smooth	<b>08.028</b>	180 mm	10 fori / holes	Ø 25	155 mm	grezzo / raw
Ø 30	liscio / smooth	<b>08.029</b>	200 mm	9 fori / holes	Ø 30	170 mm	grezzo / raw
Ø 12	liscio / smooth	<b>08.029.01</b>	120 mm	16 fori / holes	Ø 12	108 mm	grezzo / raw



sezione ferro iron section	tipo ferro iron type	codice code	interasse centre distance	nr. fori nr. of holes	tipo fori kind of holes	luce hole to hole	trattamento finishing
■ 14x14	liscio / smooth	<b>08.106</b>	140 mm	14 fori / holes	□ 24x15 rettangolo / rectangular		grezzo / raw
■ 16x16	liscio / smooth	<b>08.107</b>	150 mm	13 fori / holes	□ 30x17 rettangolo / rectangular		grezzo / raw
■ 18x18	liscio / smooth	<b>08.108</b>	160 mm	12 fori / holes	□ 31x19 rettangolo / rectangular		grezzo / raw
■ 20x20	liscio / smooth	<b>08.109</b>	170 mm	11 fori / holes	□ 33x21 rettangolo / rectangular		grezzo / raw



Ø 14	corteccia / bark	<b>08.109.01</b>	140 mm	14 fori / holes	Ø 14	126 mm	grezzo / raw
Ø 16	corteccia / bark	<b>08.109.02</b>	150 mm	13 fori / holes	Ø 16	126 mm	grezzo / raw
Ø 18	corteccia / bark	<b>08.109.03</b>	160 mm	12 fori / holes	Ø 18	142 mm	grezzo / raw
Ø 20	corteccia / bark	<b>08.109.04</b>	170 mm	11 fori / holes	Ø 20	150 mm	grezzo / raw
Ø 22	corteccia / bark	<b>08.109.05</b>	170 mm	11 fori / holes	Ø 22	148 mm	grezzo / raw



■ 12x12	martellato / hammered	<b>08.110</b>	120 mm	16 fori / holes	□ 12x12	108 mm	grezzo / raw
■ 14x14	martellato / hammered	<b>08.111</b>	140 mm	14 fori / holes	□ 14x14	126 mm	grezzo / raw
■ 16x16	martellato / hammered	<b>08.112</b>	150 mm	13 fori / holes	□ 16x16	134 mm	grezzo / raw
■ 18x18	martellato / hammered	<b>08.113</b>	160 mm	12 fori / holes	□ 18x18	142 mm	grezzo / raw
■ 20x20	martellato / hammered	<b>08.114</b>	170 mm	11 fori / holes	□ 20x20	150 mm	grezzo / raw



■ 14x14	corteccia / bark	<b>08.114.01</b>	140 mm	14 fori / holes	□ 14x14	126 mm	grezzo / raw
■ 16x16	corteccia / bark	<b>08.114.02</b>	150 mm	13 fori / holes	□ 16x16	134 mm	grezzo / raw



■ 14x14	corteccia / bark	<b>08.114.10</b>	140 mm	14 fori / holes	◇ 14x14	120 mm	grezzo / raw
■ 16x16	corteccia / bark	<b>08.114.11</b>	150 mm	13 fori / holes	◇ 16x16	127 mm	grezzo / raw



■ 14x14	martellato / hammered	<b>08.114.20</b>	140 mm	14 fori / holes	◇ 14x14 sullo spigolo / on the edge	120 mm	grezzo / raw
■ 16x16	martellato / hammered	<b>08.114.21</b>	150 mm	13 fori / holes	◇ 16x16 sullo spigolo / on the edge	127 mm	grezzo / raw



■ 12x12	in spigolo / edged	<b>08.114.30</b>	120 mm	16 fori / holes	□ 12x12	108 mm	grezzo / raw
■ 14x14	in spigolo / edged	<b>08.114.31</b>	140 mm	14 fori / holes	□ 14x14	126 mm	grezzo / raw
■ 16x16	in spigolo / edged	<b>08.114.32</b>	150 mm	13 fori / holes	□ 16x16	134 mm	grezzo / raw
■ 18x18	in spigolo / edged	<b>08.114.33</b>	160 mm	12 fori / holes	□ 18x18	142 mm	grezzo / raw



Ø 14	liscio / smooth	<b>08.115</b>	125 mm	15 fori / holes	Ø 14	111 mm	grezzo / raw
Ø 14	liscio / smooth	<b>08.115.01</b>	130 mm	14 fori / holes	Ø 14	116 mm	grezzo / raw
Ø 16	liscio / smooth	<b>08.116</b>	125 mm	15 fori / holes	Ø 16	109 mm	grezzo / raw
Ø 16	liscio / smooth	<b>08.116.01</b>	160 mm	12 fori / holes	Ø 16	144 mm	grezzo / raw
Ø 18	liscio / smooth	<b>08.117</b>	128 mm	14 fori / holes	Ø 18	110 mm	grezzo / raw
Ø 20	liscio / smooth	<b>08.118</b>	130 mm	13 fori / holes	Ø 20	110 mm	grezzo / raw



sezione ferro iron section	tipo ferro iron type	codice code	interasse centre distance	nr. fori nr. of holes	tipo fori kind of holes	luce hole to hole	trattamento finishing
■ 14x14	liscio / smooth	<b>08.119</b>	125 mm	15 fori / holes	□ 14x14	111 mm	grezzo / raw
■ 14x14	liscio / smooth	<b>08.119.01</b>	125 mm	14 fori / holes	□ 14x14	111 mm.	grezzo / raw
■ 16x16	liscio / smooth	<b>08.120</b>	125 mm	15 fori / holes	□ 16x16	109 mm	grezzo / raw
■ 16x16	liscio / smooth	<b>08.120.01</b>	135 mm	14 fori / holes	□ 16x16	119 mm	grezzo / raw
■ 18x18	liscio / smooth	<b>08.121</b>	128 mm	14 fori / holes	□ 18x18	110 mm	grezzo / raw
■ 20x20	liscio / smooth	<b>08.122</b>	130 mm	13 fori / holes	□ 20x20	110 mm	grezzo / raw



■ 14x14	liscio / smooth	<b>08.123</b>	128 mm	14 fori / holes	◇ 14x14 sullo spigolo / on the edge	108 mm	grezzo / raw
■ 16x16	liscio / smooth	<b>08.124</b>	130 mm	14 fori / holes	◇ 16x16 sullo spigolo / on the edge	107 mm	grezzo / raw
■ 18x18	liscio / smooth	<b>08.125</b>	132 mm	14 fori / holes	◇ 18x18 sullo spigolo / on the edge	107 mm	grezzo / raw
■ 20x20	liscio / smooth	<b>08.126</b>	134 mm	13 fori / holes	◇ 20x20 sullo spigolo / on the edge	106 mm	grezzo / raw



■ 14x14	liscio / smooth	<b>08.127</b>	128 mm	14 fori / holes	◇ 14x14	108 mm	grezzo / raw
■ 14x14	liscio / smooth	<b>08.127.01</b>	135 mm	14 fori / holes	◇ 14x14	115 mm	grezzo / raw
■ 16x16	liscio / smooth	<b>08.128</b>	130 mm	14 fori / holes	◇ 16x16	107 mm	grezzo / raw
■ 16x16	liscio / smooth	<b>08.128.01</b>	135 mm	14 fori / holes	◇ 16x16	112 mm	grezzo / raw
■ 16x16	liscio / smooth	<b>08.128.02</b>	125 mm	15 fori / holes	◇ 16x16	102 mm	grezzo / raw
■ 18x18	liscio / smooth	<b>08.129</b>	132 mm	14 fori / holes	◇ 18x18	107 mm	grezzo / raw
■ 18x18	liscio / smooth	<b>08.129.01</b>	135 mm	14 fori / holes	◇ 18x18	110 mm	grezzo / raw
■ 20x20	liscio / smooth	<b>08.130</b>	135 mm	13 fori / holes	◇ 20x20	107 mm	grezzo / raw



Ø 14	corteccia / bark	<b>08.130.01</b>	125 mm	15 fori / holes	Ø 14	111 mm	grezzo / raw
Ø 16	corteccia / bark	<b>08.130.02</b>	125 mm	15 fori / holes	Ø 16	109 mm	grezzo / raw
Ø 18	corteccia / bark	<b>08.130.03</b>	128 mm	14 fori / holes	Ø 18	110 mm	grezzo / raw



■ 16x16	liscio / smooth	<b>08.131</b>	125 mm	15 fori / holes	□ 14x14	111 mm	grezzo / raw
---------	-----------------	---------------	--------	-----------------	---------	--------	--------------



Ø 16	liscio / smooth	<b>08.132</b>	125 mm	15 fori / holes	Ø 14	111 mm	grezzo / raw
------	-----------------	---------------	--------	-----------------	------	--------	--------------





BARRE FORATE SABBIAE / SANDBLASTED HOLED BARS

sezione ferro iron section	tipo ferro iron type	codice code	interasse centre distance	nr. fori nr. of holes	tipo fori kind of holes	luce hole to hole	trattamento finishing
■ 12x12	liscio / smooth	<b>08.133</b>	120 mm	16 fori / holes	□ 12x12	108 mm	sabbiato / sandblasted
■ 14x14	liscio / smooth	<b>08.134</b>	140 mm	14 fori / holes	□ 14x14	126 mm	sabbiato / sandblasted
■ 16x16	liscio / smooth	<b>08.135</b>	150 mm	13 fori / holes	□ 16x16	134 mm	sabbiato / sandblasted
■ 18x18	liscio / smooth	<b>08.136</b>	160 mm	12 fori / holes	□ 18x18	142 mm	sabbiato / sandblasted
■ 20x20	liscio / smooth	<b>08.137</b>	170 mm	11 fori / holes	□ 20x20	150 mm	sabbiato / sandblasted
■ 22x22	liscio / smooth	<b>08.138</b>	170 mm	11 fori / holes	□ 22x22	148 mm	sabbiato / sandblasted
■ 25x25	liscio / smooth	<b>08.139</b>	180 mm	10 fori / holes	□ 25x25	155 mm	sabbiato / sandblasted



BARRE FORATE SABBIAE / SANDBLASTED HOLED BARS

■ 14x14	liscio / smooth	<b>08.140</b>	140 mm	14 fori / holes	◇ 14x14 sullo spigolo / on the edge	120 mm	sabbiato / sandblasted
■ 16x16	liscio / smooth	<b>08.141</b>	150 mm	13 fori / holes	◇ 16x16 sullo spigolo / on the edge	127 mm	sabbiato / sandblasted
■ 18x18	liscio / smooth	<b>08.142</b>	160 mm	12 fori / holes	◇ 18x18 sullo spigolo / on the edge	135 mm	sabbiato / sandblasted
■ 20x20	liscio / smooth	<b>08.143</b>	170 mm	11 fori / holes	◇ 20x20 sullo spigolo / on the edge	142 mm	sabbiato / sandblasted
■ 22x22	liscio / smooth	<b>08.144</b>	170 mm	11 fori / holes	◇ 22x22 sullo spigolo / on the edge	139 mm	sabbiato / sandblasted
■ 25x25	liscio / smooth	<b>08.145</b>	180 mm	10 fori / holes	◇ 25x25 sullo spigolo / on the edge	145 mm	sabbiato / sandblasted



BARRE FORATE SABBIAE / SANDBLASTED HOLED BARS

■ 14x14	liscio / smooth	<b>08.146</b>	140 mm	14 fori / holes	◇ 14x14	120 mm	sabbiato / sandblasted
■ 16x16	liscio / smooth	<b>08.147</b>	150 mm	13 fori / holes	◇ 16x16	127 mm	sabbiato / sandblasted
■ 18x18	liscio / smooth	<b>08.148</b>	160 mm	12 fori / holes	◇ 18x18	135 mm	sabbiato / sandblasted
■ 20x20	liscio / smooth	<b>08.149</b>	170 mm	11 fori / holes	◇ 20x20	142 mm	sabbiato / sandblasted
■ 22x22	liscio / smooth	<b>08.150</b>	170 mm	11 fori / holes	◇ 22x22	139 mm	sabbiato / sandblasted
■ 25x25	liscio / smooth	<b>08.151</b>	180 mm	10 fori / holes	◇ 25x25	145 mm	sabbiato / sandblasted



BARRE FORATE SABBIAE / SANDBLASTED HOLED BARS

Ø 14	liscio / smooth	<b>08.152</b>	140 mm	14 fori / holes	⊖ 14x26 mm ovale / oval		sabbiato / sandblasted
Ø 16	liscio / smooth	<b>08.153</b>	150 mm	13 fori / holes	⊖ 16x28 mm ovale / oval		sabbiato / sandblasted
Ø 18	liscio / smooth	<b>08.154</b>	160 mm	12 fori / holes	⊖ 18x30 mm ovale / oval		sabbiato / sandblasted
Ø 20	liscio / smooth	<b>08.155</b>	170 mm	11 fori / holes	⊖ 20x33 mm ovale / oval		sabbiato / sandblasted

## BARRE FORATE SABBIASTE HOLED BARS SAND - BLASTED



BARRE FORATE SABBIASTE / SANDBLASTED HOLED BARS

sezione ferro iron section	tipo ferro iron type	codice code	interasse centre distance	nr. fori nr. of holes	tipo fori kind of holes	luce hole to hole	trattamento finishing
Ø 12	liscio / smooth	<b>08.156</b>	120 mm	16 fori / holes	Ø 12	108 mm	sabbiato / sandblasted
Ø 14	liscio / smooth	<b>08.157</b>	140 mm	14 fori / holes	Ø 14	126 mm	sabbiato / sandblasted
Ø 16	liscio / smooth	<b>08.158</b>	150 mm	13 fori / holes	Ø 16	126 mm	sabbiato / sandblasted
Ø 18	liscio / smooth	<b>08.159</b>	160 mm	12 fori / holes	Ø 18	142 mm	sabbiato / sandblasted
Ø 20	liscio / smooth	<b>08.160</b>	170 mm	11 fori / holes	Ø 20	150 mm	sabbiato / sandblasted
Ø 22	liscio / smooth	<b>08.161</b>	170 mm	11 fori / holes	Ø 22	148 mm	sabbiato / sandblasted
Ø 25	liscio / smooth	<b>08.162</b>	180 mm	10 fori / holes	Ø 25	155 mm	sabbiato / sandblasted
Ø 30	liscio / smooth	<b>08.163</b>	200 mm	9 fori / holes	Ø 30	170 mm	sabbiato / sandblasted
Ø 14	liscio / smooth	<b>08.164</b>	125 mm	15 fori / holes	Ø 14	111 mm	sabbiato / sandblasted
Ø 14	liscio / smooth	<b>08.164.01</b>	130 mm	14 fori / holes	Ø 14	116 mm	sabbiato / sandblasted
Ø 16	liscio / smooth	<b>08.165</b>	125 mm	15 fori / holes	Ø 16	109 mm	sabbiato / sandblasted
Ø 16	liscio / smooth	<b>08.165.01</b>	160 mm	12 fori / holes	Ø 16	144 mm	sabbiato / sandblasted
Ø 18	liscio / smooth	<b>08.166</b>	128 mm	14 fori / holes	Ø 18	110 mm	sabbiato / sandblasted
Ø 20	liscio / smooth	<b>08.167</b>	130 mm	13 fori / holes	Ø 20	110 mm	sabbiato / sandblasted



BARRE FORATE SABBIASTE / SANDBLASTED HOLED BARS

■ 14x14	liscio / smooth	<b>08.168</b>	125 mm	15 fori / holes	□ 14x14	111 mm	sabbiato / sandblasted
■ 14x14	liscio / smooth	<b>08.168.01</b>	125 mm	14 fori / holes	□ 14x14	111 mm.	sabbiato / sandblasted
■ 16x16	liscio / smooth	<b>08.169</b>	125 mm	15 fori / holes	□ 16x16	109 mm	sabbiato / sandblasted
■ 16x16	liscio / smooth	<b>08.169.01</b>	135 mm	14 fori / holes	□ 16x16	119 mm	sabbiato / sandblasted
■ 18x18	liscio / smooth	<b>08.170</b>	128 mm	14 fori / holes	□ 18x18	110 mm	sabbiato / sandblasted
■ 20x20	liscio / smooth	<b>08.171</b>	130 mm	13 fori / holes	□ 20x20	110 mm	sabbiato / sandblasted



BARRE FORATE SABBIASTE / SANDBLASTED HOLED BARS

■ 14x14	liscio / smooth	<b>08.172</b>	128 mm	14 fori / holes	◇14x14 sullo spigolo / on the edge	108 mm	sabbiato / sandblasted
■ 16x16	liscio / smooth	<b>08.173</b>	130 mm	14 fori / holes	◇16x16 sullo spigolo / on the edge	107 mm	sabbiato / sandblasted
■ 18x18	liscio / smooth	<b>08.174</b>	132 mm	14 fori / holes	◇18x18 sullo spigolo / on the edge	107 mm	sabbiato / sandblasted
■ 20x20	liscio / smooth	<b>08.175</b>	134 mm	13 fori / holes	◇20x20 sullo spigolo / on the edge	106 mm	sabbiato / sandblasted



BARRE FORATE SABBIAATE / SANDBLASTED HOLED BARS

sezione ferro iron section	tipo ferro iron type	codice code	interasse centre distance	nr. fori nr. of holes	tipo fori kind of holes	luce hole to hole	trattamento finishing
■ 14x14	liscio / smooth	<b>08.176</b>	128 mm	14 fori / holes	◇14x14	108 mm	sabbiato / sandblasted
■ 14x14	liscio / smooth	<b>08.176.01</b>	135 mm	14 fori / holes	◇14x14	115 mm	sabbiato / sandblasted
■ 16x16	liscio / smooth	<b>08.177</b>	130 mm	14 fori / holes	◇16x16	107 mm	sabbiato / sandblasted
■ 16x16	liscio / smooth	<b>08.177.01</b>	135 mm	14 fori / holes	◇16x16	112 mm	sabbiato / sandblasted
■ 16x16	liscio / smooth	<b>08.177.02</b>	125 mm	15 fori / holes	◇16x16	102 mm	sabbiato / sandblasted
■ 18x18	liscio / smooth	<b>08.178</b>	132 mm	14 fori / holes	◇18x18	107 mm	sabbiato / sandblasted
■ 18x18	liscio / smooth	<b>08.178.01</b>	135 mm	14 fori / holes	◇18x18	110 mm	sabbiato / sandblasted
■ 20x20	liscio / smooth	<b>08.179</b>	135 mm	13 fori / holes	◇20x20	107 mm	sabbiato / sandblasted



BARRE FORATE SABBIAATE / SANDBLASTED HOLED BARS

■ 16x16	liscio / smooth	<b>08.180</b>	125 mm	15 fori / holes	□ 14x14	111 mm	sabbiato / sandblasted
---------	-----------------	---------------	--------	-----------------	---------	--------	------------------------



BARRE FORATE SABBIAATE / SANDBLASTED HOLED BARS

Ø 16	liscio / smooth	<b>08.181</b>	125 mm	15 fori / holes	Ø 14	111 mm	sabbiato / sandblasted
------	-----------------	---------------	--------	-----------------	------	--------	------------------------







# LASERFER

BY EUROFER

## LASERFER TRASFORMA LE IDEE IN TAGLI DI LUCE.

Per migliorare la capacità di essere sempre al servizio del cliente, EUROFER ha deciso di ampliare la propria gamma con gli articoli tagliati al laser e con una tecnologia che permetterà ai disegni di prendere forma.

Oltre agli elementi tradizionali quali piastre, terminali ed ornamenti, sono proposti pannelli per recinzioni, per cancelli, per portali o per decoro.

Accanto alle nuove tematiche proposte dai Designers in questo catalogo, sulle superfici come il ferro, l'acciaio inossidabile e il corten si possono realizzare figure o soggetti a piacere. Il ferro della lastra può essere zincato o colorato, LASERFER propone quindi un prodotto finito e di sicuro effetto.

## LASERFER TURNS IDEAS INTO DESIGNS OF LIGHT.

To improve the capacity of always being about customer service, EUROFER has decided to extend its range with laser-cut products thanks to a technology that will allow drawings to take shape.

Besides traditional elements like plates, frets and ornaments for railings, there are also panels for enclosures, gates, portals or just for pure aesthetic.

Next to Designers' new issues in this catalogue, for what concerns surfaces like iron, stainless steel and corten, it's possible to create new figures or objects as desired.

Sheet iron can be galvanised or coloured, LASERFER proposes a finished product with a huge impact.

- 1** Scegli, nello schema della pagina seguente, i pannelli che vuoi ordinare.  
*In the pattern in the following page, choose the panels corresponding to your gate /fencing.*

ESEMPIO / EXAMPLE: CANCELLO PRINCIPALE E RECINZIONE / FRONT GATE AND FENCING

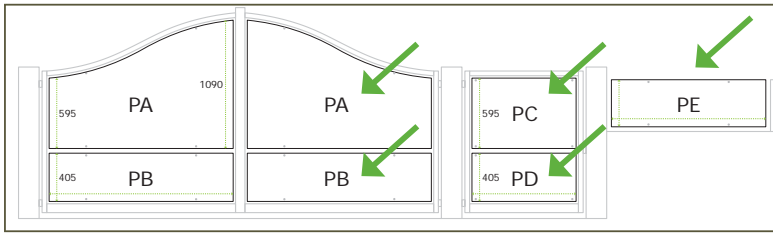

**CANCELLO PRINCIPALE:**  
 PANNELLO PA DESTRO E SINISTRO  
 PANNELLO PB DESTRO E SINISTRO  
**FRONT GATE:**  
 PANEL PA RIGHT AND LEFT  
 PANEL PB RIGHT AND LEFT

**CANCELLETTO PEDONALE:**  
 PANNELLO PC - PANNELLO PD  
**PEDESTRIAN GATE:**  
 PANEL PC - PANEL PD

**RECINZIONE:** PANNELLO PE  
**FENCING:** PANEL PE

- 2** Scegli poi il decoro nelle pagine seguenti.  
*Select the pattern in the following pages.*

ESEMPIO / EXAMPLE: PARALLELOS LINE 07 - 09 - 10

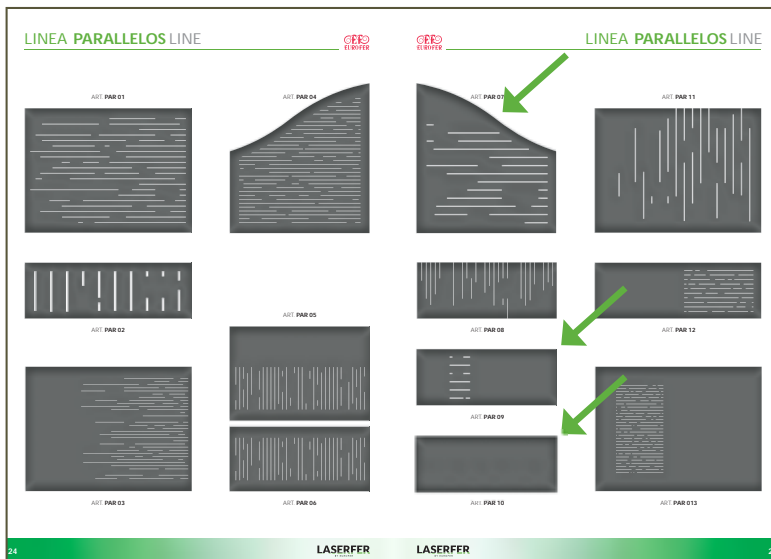

- 3** Indica poi:  
 TIPO DI PANNELLO SCELTO, DECORO E QUANTITÀ  
*Please indicate: KIND OF PANEL, DECORATION AND QUANTITY*

ESEMPIO / EXAMPLE:

PA destro / right	<b>PARALLELOS LINE 07</b>	n° 1
PA sinistro / left	<b>PARALLELOS LINE 07</b>	n° 1
PB destro / right	<b>PARALLELOS LINE 10</b>	n° 1
PB sinistro / left	<b>PARALLELOS LINE 10</b>	n° 1
PC	<b>PARALLELOS LINE 07</b>	n° 1
PD	<b>PARALLELOS LINE 10</b>	n° 1
PE	<b>PARALLELOS LINE 09</b>	n° 2

- 4** Completa il tuo ordine indicando lo spessore della lamiera, il tipo di materiale e la finitura.  
*Complete your order with: thickness plate, material type and finish.*

Ed ecco visualizzato il Vostro ordine / And now your plan:

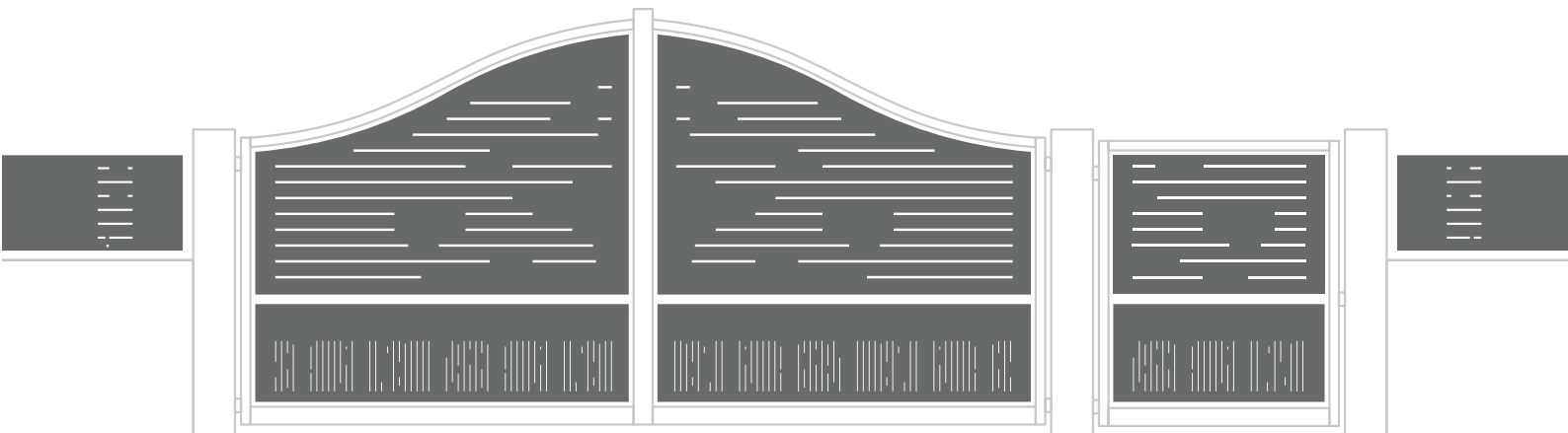

La fattibilità della realizzazione del decoro va verificata in base a dimensioni e spessori della lastra. / The feasibility of making certain decorations may depend on plate size and thickness.

Tutte le parti di questo catalogo - foto comprese - sono di proprietà Euro-Fer. La riproduzione, anche parziale, è vietata in ogni forma e con ogni mezzo. / Every part of this catalogue - photos included - is Euro-Fer's property. All forms of copying are strictly prohibited.



CODICI - DIMENSIONI / CODES - DIMENSIONS

**PA**

Decoro / Design \_\_\_\_\_  
N° pz. / N° pcs. \_\_\_\_\_

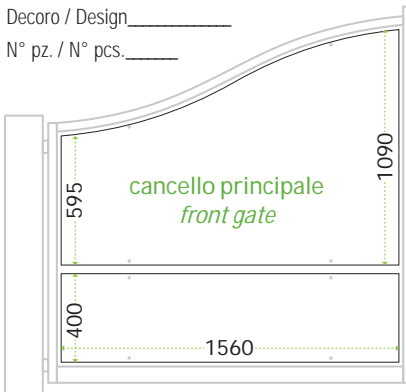

**PA**

Decoro / Design \_\_\_\_\_  
N° pz. / N° pcs. \_\_\_\_\_

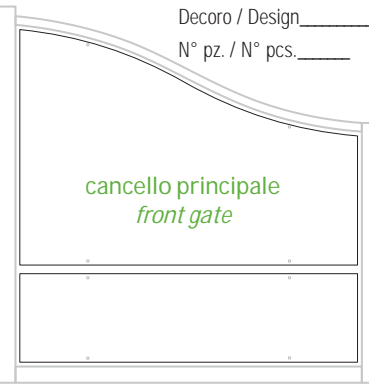

**PC**

Decoro / Design \_\_\_\_\_  
N° pz. / N° pcs. \_\_\_\_\_

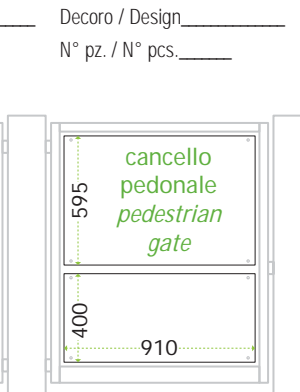

**PE**

Decoro / Design \_\_\_\_\_  
N° pz. / N° pcs. \_\_\_\_\_

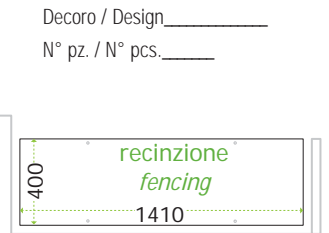

**PB**

Decoro / Design \_\_\_\_\_  
N° pz. / N° pcs. \_\_\_\_\_

**PB**

Decoro / Design \_\_\_\_\_  
N° pz. / N° pcs. \_\_\_\_\_

**PD**

Decoro / Design \_\_\_\_\_  
N° pz. / N° pcs. \_\_\_\_\_

**PF**

Decoro / Design \_\_\_\_\_  
N° pz. / N° pcs. \_\_\_\_\_

**PF**

Decoro / Design \_\_\_\_\_  
N° pz. / N° pcs. \_\_\_\_\_

**PG**

Decoro / Design \_\_\_\_\_  
N° pz. / N° pcs. \_\_\_\_\_

**PH**

Decoro / Design \_\_\_\_\_  
N° pz. / N° pcs. \_\_\_\_\_

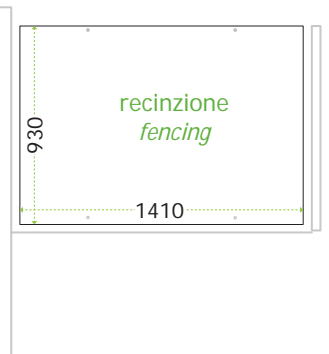
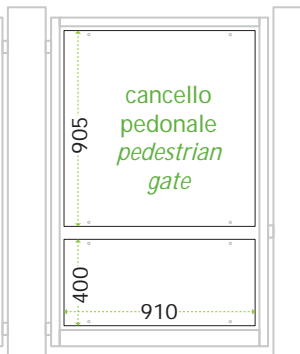
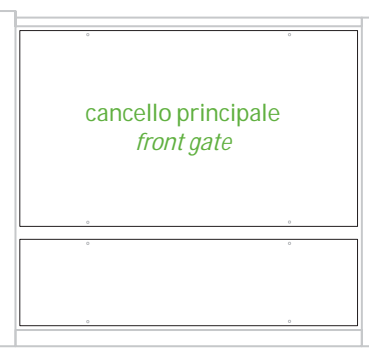
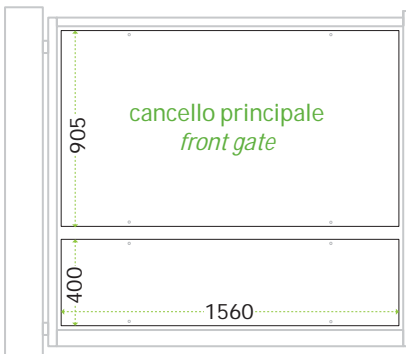

**PB**

Decoro / Design \_\_\_\_\_  
N° pz. / N° pcs. \_\_\_\_\_

**PB**

Decoro / Design \_\_\_\_\_  
N° pz. / N° pcs. \_\_\_\_\_

**PD**

Decoro / Design \_\_\_\_\_  
N° pz. / N° pcs. \_\_\_\_\_

DECORAZIONE / DESIGN



Scegli i decori Laserfer  
Choose a Laserfer design



Allega il tuo file .dxf  
Send us your .dxf file



Allega il tuo disegno  
Send us your sketch

SPESSORI - MATERIALI E FINITURE / THICKNESS - MATERIALS AND FINISHING

Spessore Lamiera  
Sheet Thickness

- 20/10
- 25/10
- 30/10
- 40/10
- .....

Materiale / Material  
Finitura / Finishing

- FERRO GREZZO / RAW IRON
- PRE-ZINCATO / GALVANIZED
- PRE-ZINCATO VERNICIATO  
PRE-GALVANIZED POWDER COATED

- COR-TEN
- INOX 304
- INOX 316



RAL.....

For specific questions regarding finish, colouring, or technical topics, please contact your local sales office.

La fattibilità della realizzazione del decoro va verificata in base a dimensioni e spessori della lastra. / The feasibility of making certain decorations may depend on plate size and thickness.  
Tutte le parti di questo catalogo - foto comprese - sono di proprietà Euro-Fer. La riproduzione, anche parziale, è vietata in ogni forma e con ogni mezzo. / Every part of this catalogue - photos included - is Euro-Fer's property. All forms of copying are strictly prohibited.

## CODICI - DIMENSIONI / CODES - DIMENSIONS

## PA

Decoro / Design \_\_\_\_\_  
N° pz. / N° pcs. \_\_\_\_\_

## PA

Decoro / Design \_\_\_\_\_  
N° pz. / N° pcs. \_\_\_\_\_

## PC

Decoro / Design \_\_\_\_\_  
N° pz. / N° pcs. \_\_\_\_\_

## PE

Decoro / Design \_\_\_\_\_  
N° pz. / N° pcs. \_\_\_\_\_

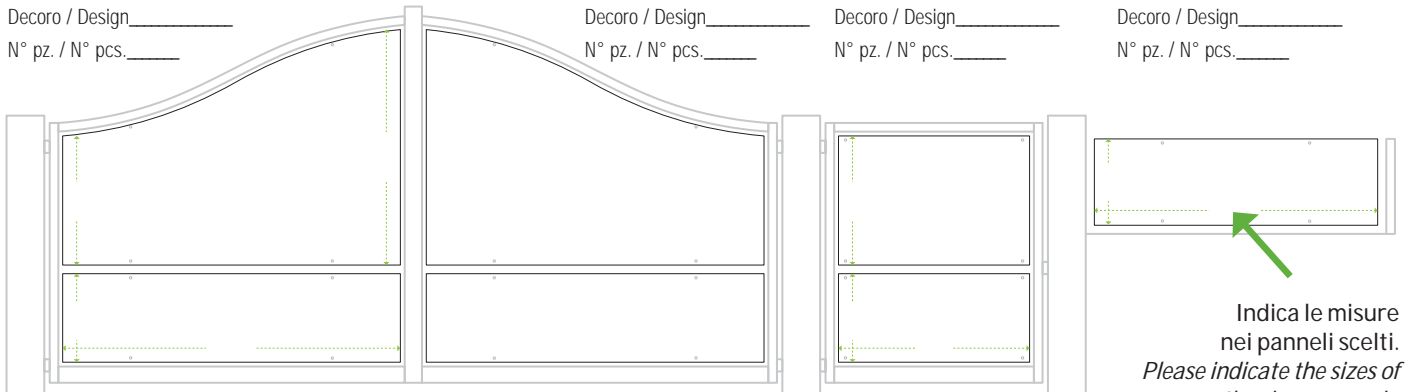

## PB

Decoro / Design \_\_\_\_\_  
N° pz. / N° pcs. \_\_\_\_\_

## PB

Decoro / Design \_\_\_\_\_  
N° pz. / N° pcs. \_\_\_\_\_

## PD

Decoro / Design \_\_\_\_\_  
N° pz. / N° pcs. \_\_\_\_\_

## PF

Decoro / Design \_\_\_\_\_  
N° pz. / N° pcs. \_\_\_\_\_

## PF

Decoro / Design \_\_\_\_\_  
N° pz. / N° pcs. \_\_\_\_\_

## PG

Decoro / Design \_\_\_\_\_  
N° pz. / N° pcs. \_\_\_\_\_

## PH

Decoro / Design \_\_\_\_\_  
N° pz. / N° pcs. \_\_\_\_\_

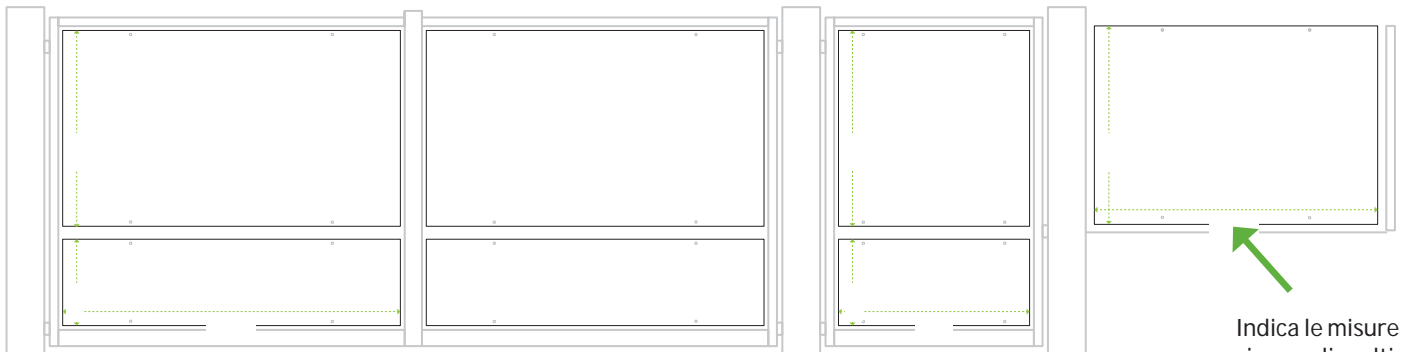

## PB

Decoro / Design \_\_\_\_\_  
N° pz. / N° pcs. \_\_\_\_\_

## PB

Decoro / Design \_\_\_\_\_  
N° pz. / N° pcs. \_\_\_\_\_

## PD

Decoro / Design \_\_\_\_\_  
N° pz. / N° pcs. \_\_\_\_\_

## DECORAZIONE / DESIGN



- Scegli i decori Laserfer  
Choose a Laserfer design



- Allega il tuo file .dxf  
Send us your .dxf file



- Allega il tuo disegno  
Send us your sketch

## SPESSORI - MATERIALI E FINITURE / THICKNESS - MATERIALS AND FINISHING

Spessore Lamiera  
Sheet Thickness

- 20/10  
 25/10  
 30/10  
 40/10  
 .....

Materiale / Material  
Finitura / Finishing

- FERRO GREZZO / RAW IRON  
 PRE-ZINCATO / GALVANIZED  
 PRE-ZINCATO VERNICIATO  
PRE-GALVANIZED POWDER COATED

- COR-TEN  
 INOX 304  
 INOX 316



RAL.....

For specific questions regarding finish, colouring, or technical topics, please contact your local sales office.

La fattibilità della realizzazione del decoro va verificata in base a dimensioni e spessori della lastra. / The feasibility of making certain decorations may depend on plate size and thickness.

Tutte le parti di questo catalogo - foto comprese - sono di proprietà Euro-Fer. La riproduzione, anche parziale, è vietata in ogni forma e con ogni mezzo. / Every part of this catalogue - photos included - is Euro-Fer's property. All forms of copying are strictly prohibited.

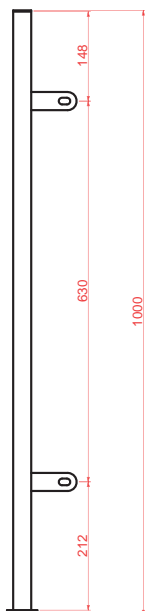
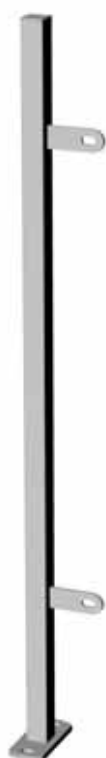

PLP 10 - H 1000 mm

Caposaldo forato con piastra di fissaggio. Comprende 2 viti M10 con dado antifurto. / *Drilled newel post with base plates to bolt down to concrete or walls. Includes 2 x M10 Bolts and snap off cone nuts to fix the panel to the post.*

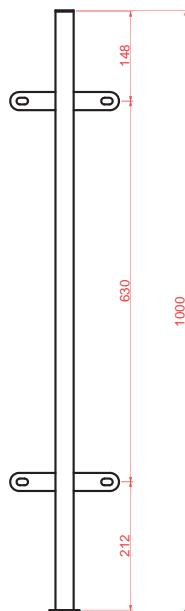
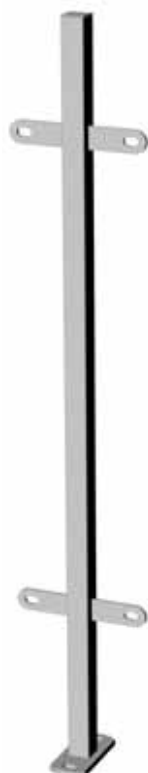

PLM 10 - H 1000 mm

Caposaldo forato con piastra di fissaggio. Comprende 4 viti M10 con dado antifurto. / *Drilled newel post with base plates to bolt down to concrete or walls. Includes 4 x M10 Bolts and snap off cone nuts to fix the panel to the post.*

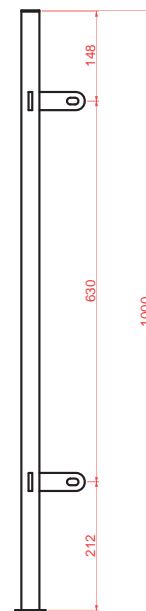
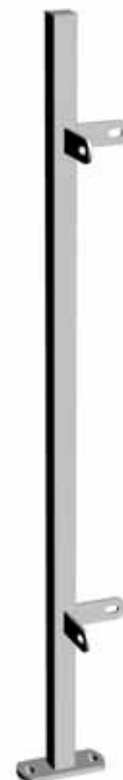

PLC 10 - H 1000 mm

Caposaldo forato con piastra di fissaggio. Comprende 4 viti M10 con dado antifurto. / *Drilled newel post with base plates to bolt down to concrete or walls. Includes 4 x M10 Bolts and snap off cone nuts to fix the panel to the post.*

**Finiture / Finishes**

Standard: piantone zincato a caldo / *galvanized post*

V: piantone zincato a caldo e verniciato / *galvanized and powder coated post*

G: piantone grezzo / *untreated post*

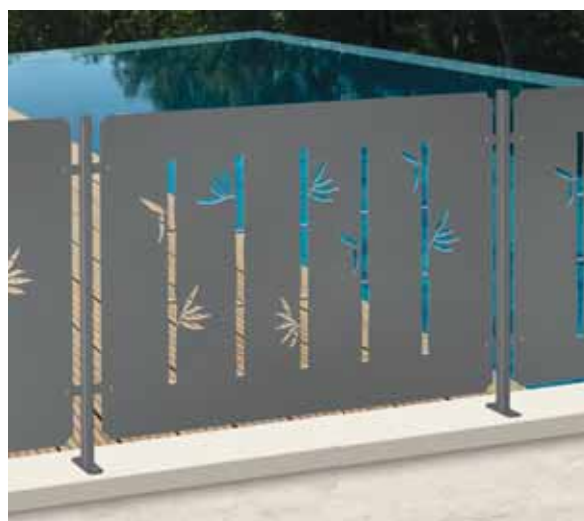

**KIT-VITI.L**  
Comprende 4 viti M 10 in ferro zincato con dado antifurto.  
*Includes 4 x M 10 bolts (galvanized iron) and snap-off cone nuts.*

I caposaldi della famiglia Laserfer sono zincati a caldo e vengono forniti con un set di viti M10 (KIT-VITI.L) zincate a freddo complete di dado antifurto per il fissaggio del pannello.  
*The Laserfer PANELS posts are hot galvanized, and include a set of M10 bolts (KIT-VITI.L) cold galvanized and snap-off cone nuts for fixing the panel.*



# LINEE LASERFER LINES

La fattibilità della realizzazione del decoro va verificata in base a dimensioni e spessori della lastra. / The feasibility of making certain decorations may depend on plate size and thickness.

Tutte le parti di questo catalogo - foto comprese - sono di proprietà Euro-Fer. La riproduzione, anche parziale, è vietata in ogni forma e con ogni mezzo. / Every part of this catalogue - photos included - is Euro-Fer's property . All forms of copying are strictly prohibited.

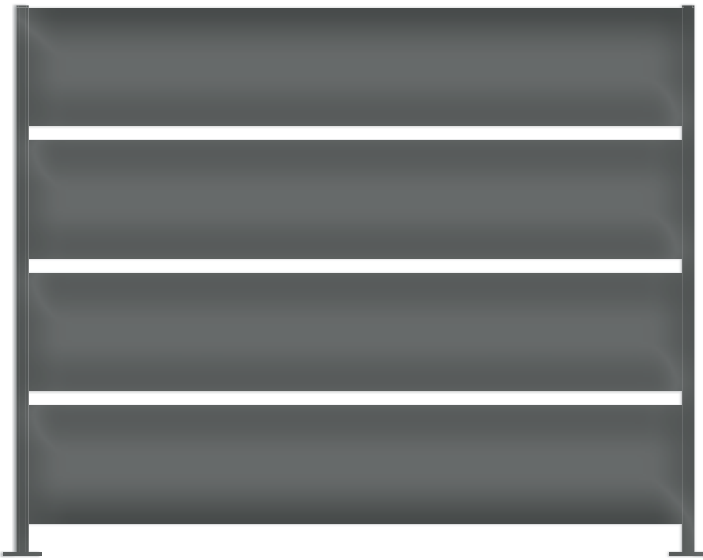
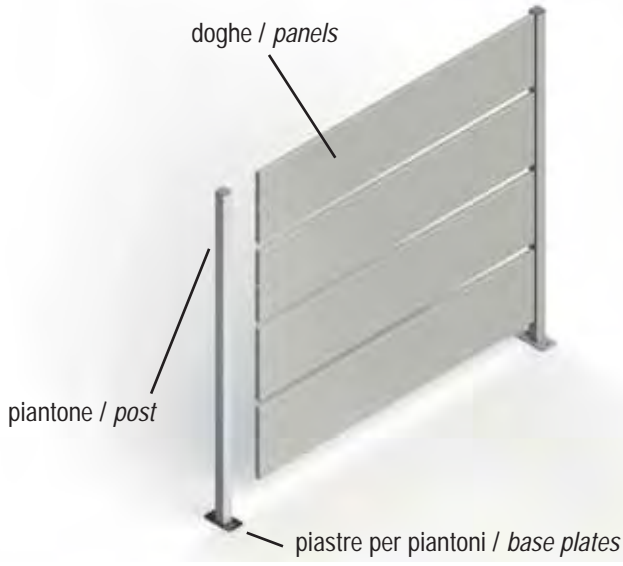

ART. SCR 01

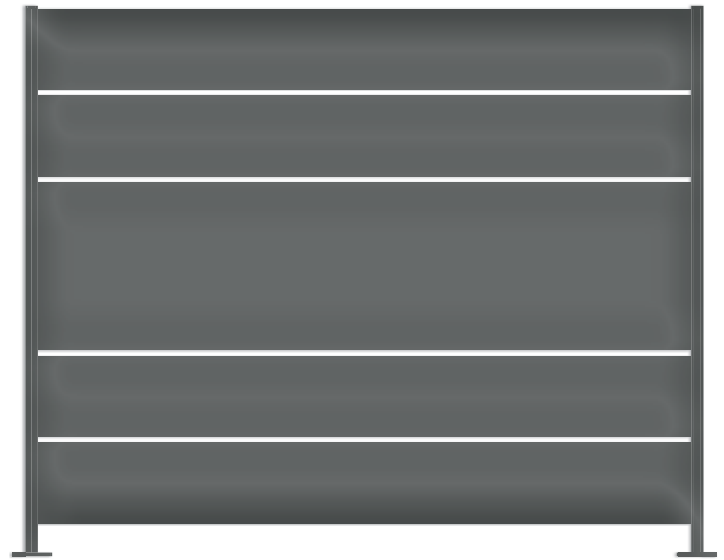

ART. SCR 02

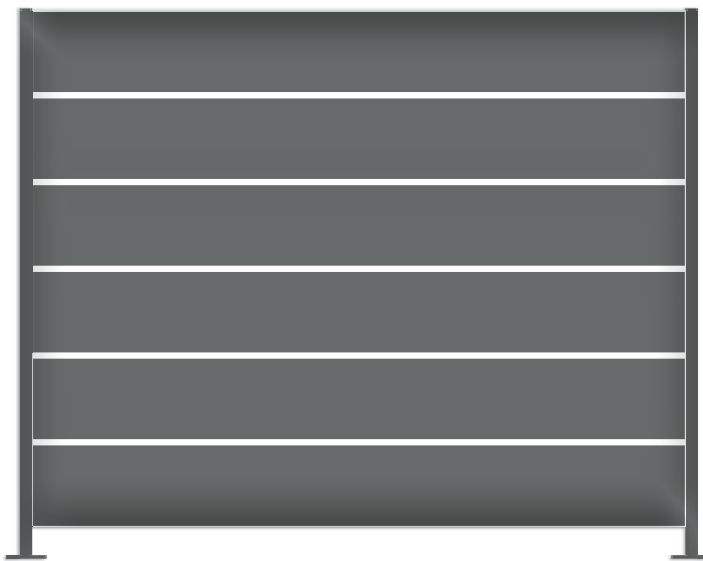

ART. SCR 03



ART. SCR 04

La fattibilità della realizzazione del decoro va verificata in base a dimensioni e spessori della lastra. / The feasibility of making certain decorations may depend on plate size and thickness.  
 Tutte le parti di questo catalogo - foto comprese - sono di proprietà Euro-Fer. La riproduzione, anche parziale, è vietata in ogni forma e con ogni mezzo. / Every part of this catalogue - photos included - is Euro-Fer's property. All forms of copying are strictly prohibited.



ART. PAR 01



ART. PAR 02



ART. PAR 03

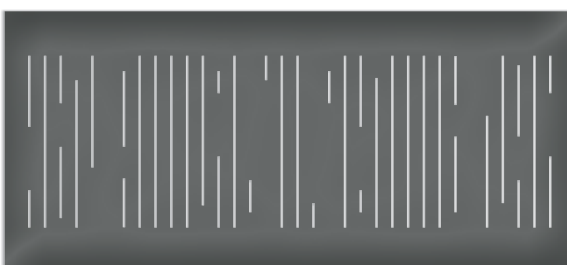

ART. PAR 06

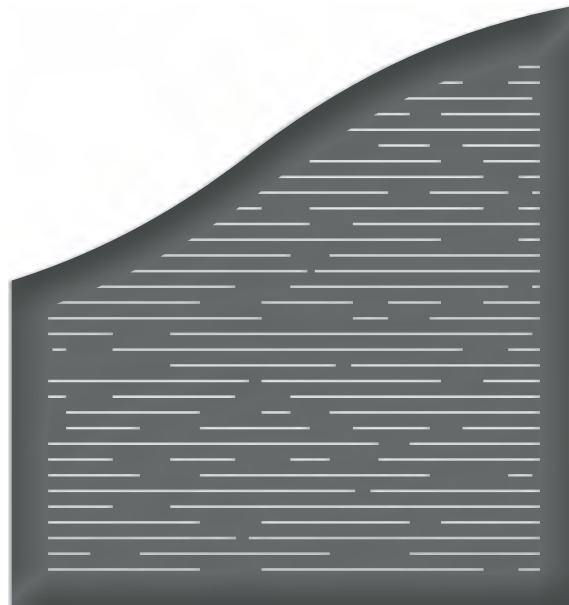

ART. PAR 04



ART. PAR 05



La fattibilità della realizzazione del decoro va verificata in base a dimensioni e spessori della lastra. / The feasibility of making certain decorations may depend on plate size and thickness.

Tutte le parti di questo catalogo - foto comprese - sono di proprietà Euro-Fer. La riproduzione, anche parziale, è vietata in ogni forma e con ogni mezzo. / Every part of this catalogue - photos included - is Euro-Fer's property. All forms of copying are strictly prohibited.





ART. PAR 07



ART. PAR 09

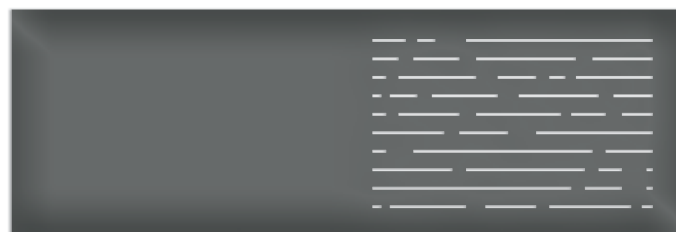

ART. PAR 12



ART. PAR 10

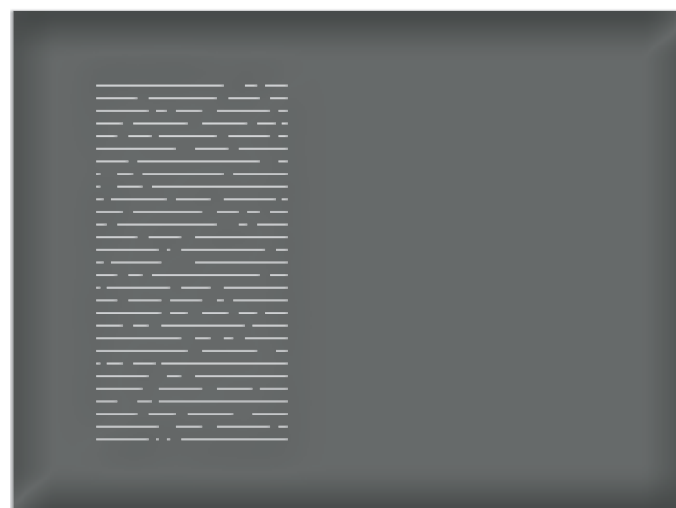

ART. PAR 13

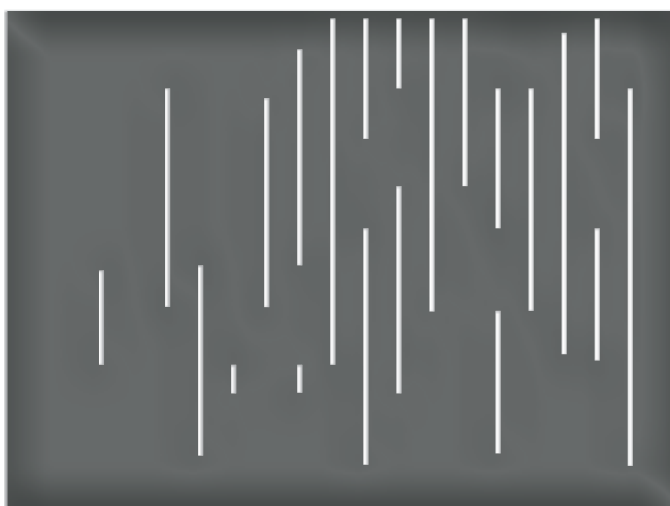

ART. PAR 11

La fattibilità della realizzazione del decoro va verificata in base a dimensioni e spessori della lastra. / The feasibility of making certain decorations may depend on plate size and thickness.

Tutte le parti di questo catalogo - foto comprese - sono di proprietà Euro-Fer. La riproduzione, anche parziale, è vietata in ogni forma e con ogni mezzo. / Every part of this catalogue - photos included - is Euro-Fer's property. All forms of copying are strictly prohibited.

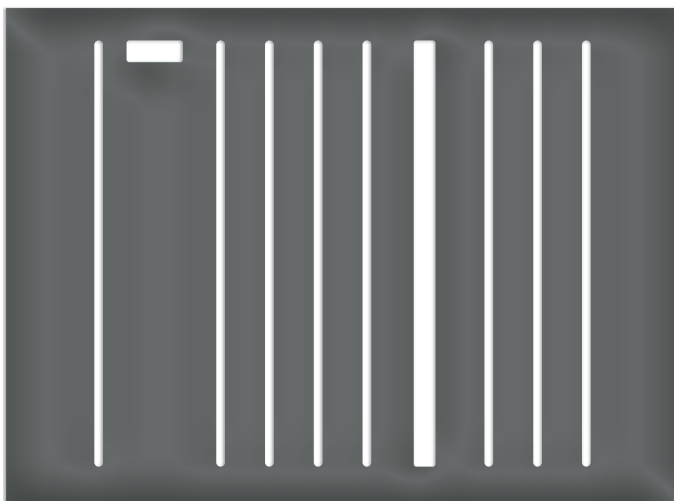

ART. PAR 14



ART. PAR 15

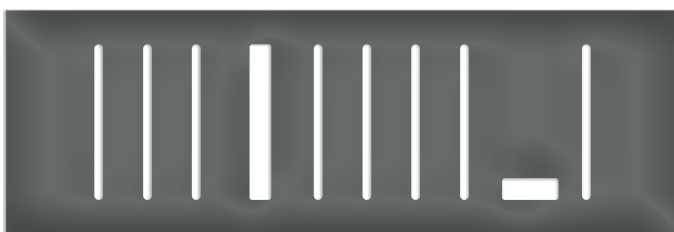

ART. PAR 16

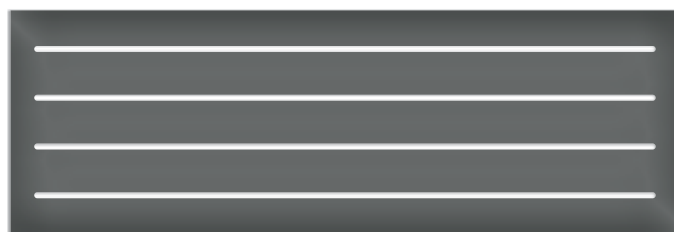

ART. PAR 17

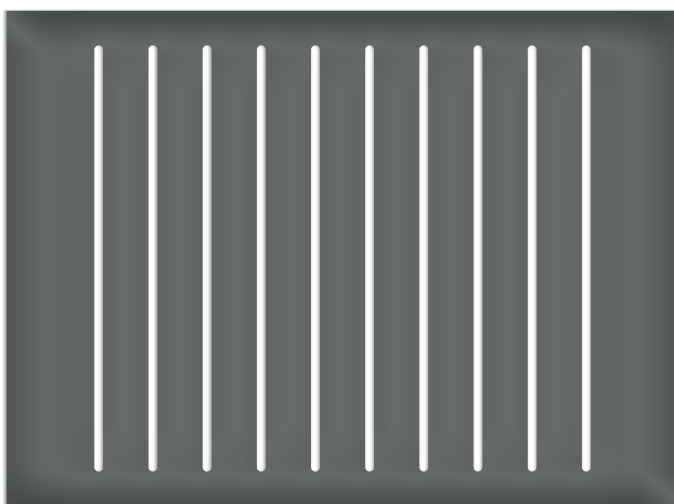

ART. PAR 18

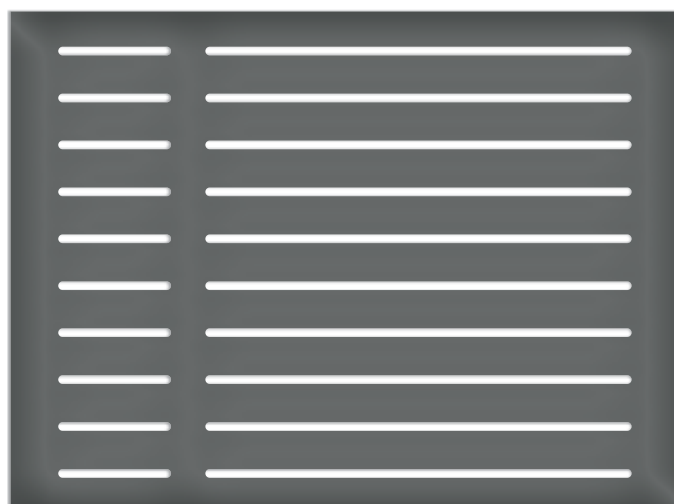

ART. PAR 19

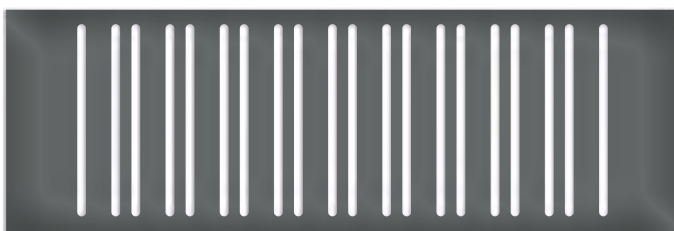

ART. PAR 20

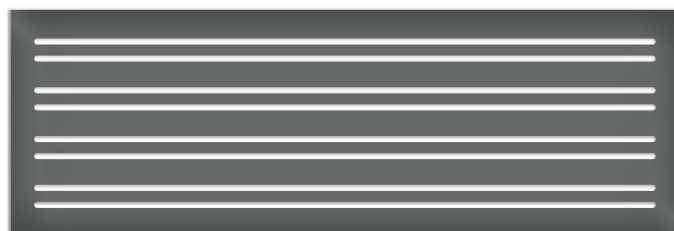

ART. PAR 21

La fattibilità della realizzazione del decoro va verificata in base a dimensioni e spessori della lastra. / The feasibility of making certain decorations may depend on plate size and thickness.

Tutte le parti di questo catalogo - foto comprese - sono di proprietà Euro-Fer. La riproduzione, anche parziale, è vietata in ogni forma e con ogni mezzo. / Every part of this catalogue - photos included - is Euro-Fer's property. All forms of copying are strictly prohibited.

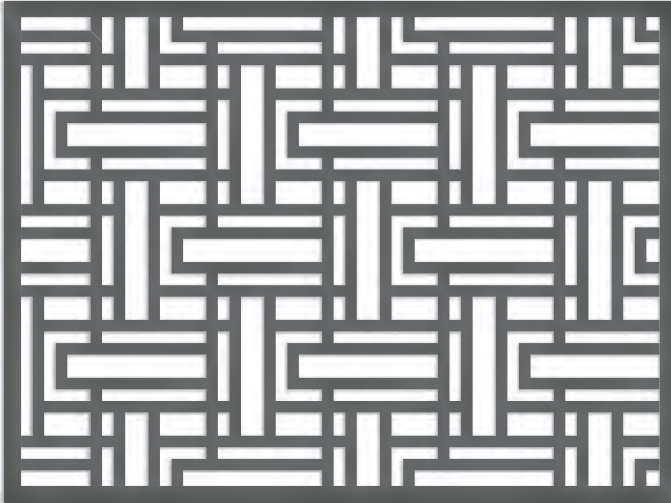

ART. GEO 01

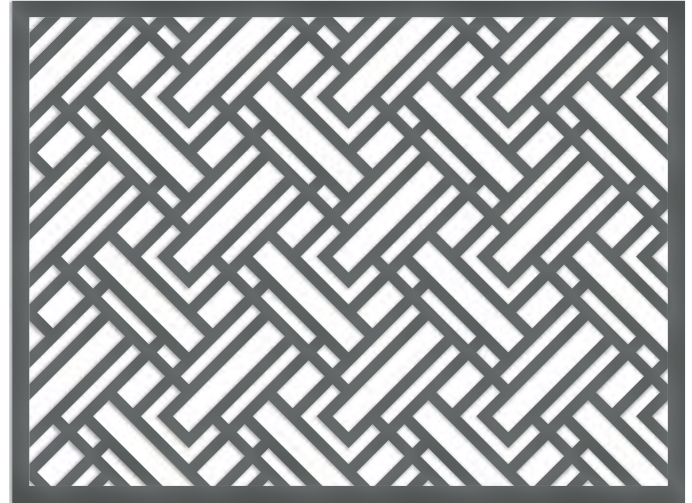

ART. GEO 02

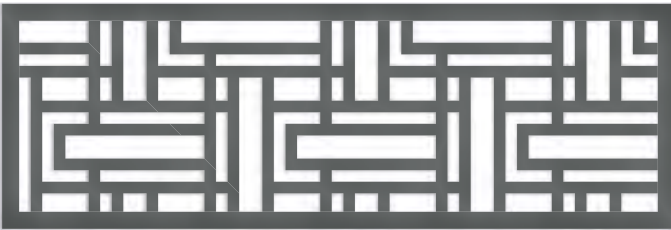

ART. GEO 03

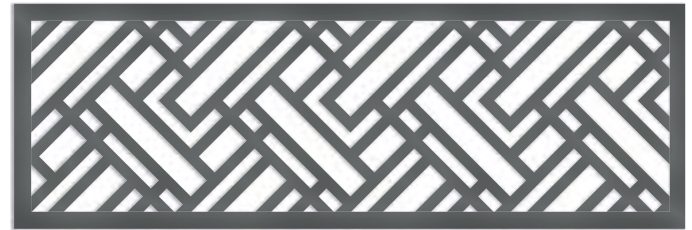

ART. GEO 04

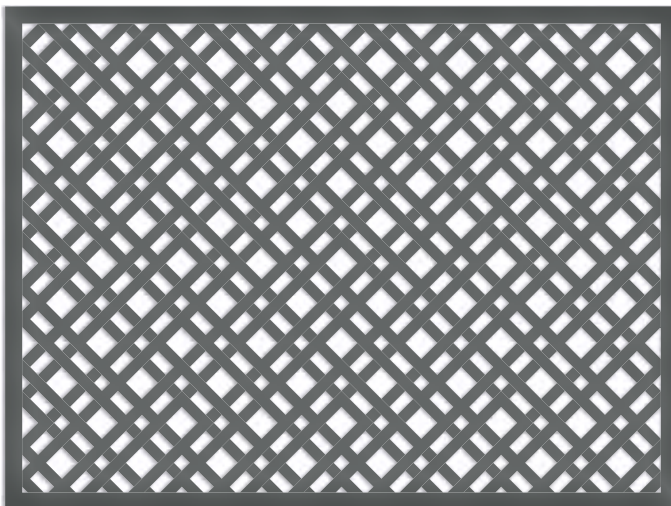

ART. GEO 05

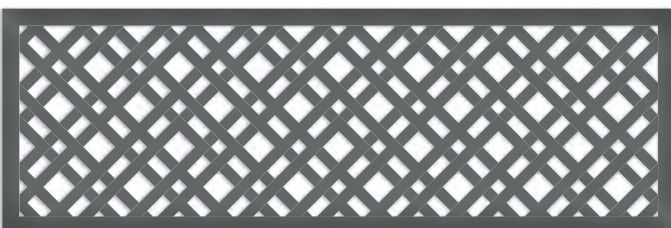

ART. GEO 06



La fattibilità della realizzazione del decoro va verificata in base a dimensioni e spessori della lastra. / The feasibility of making certain decorations may depend on plate size and thickness.  
Tutte le parti di questo catalogo - foto comprese - sono di proprietà Euro-Fer. La riproduzione, anche parziale, è vietata in ogni forma e con ogni mezzo. / Every part of this catalogue - photos included - is Euro-Fer's property. All forms of copying are strictly prohibited.



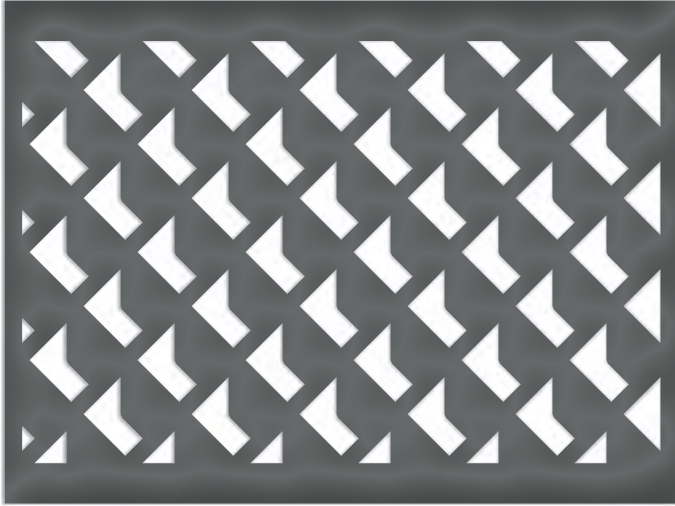

ART. QUA 05

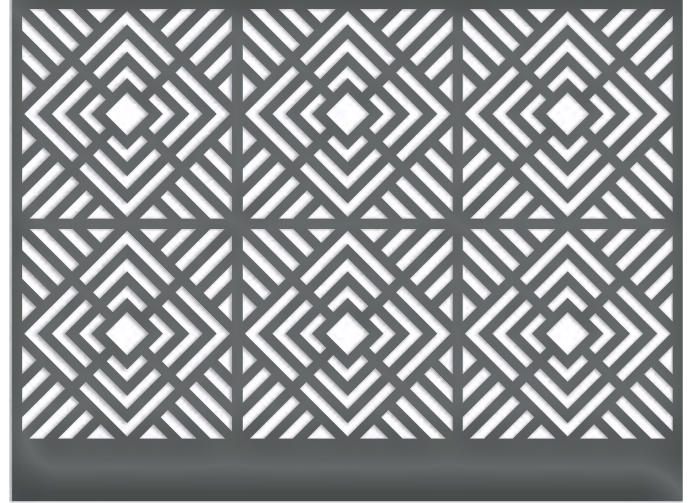

NEW

ART. QUA 07

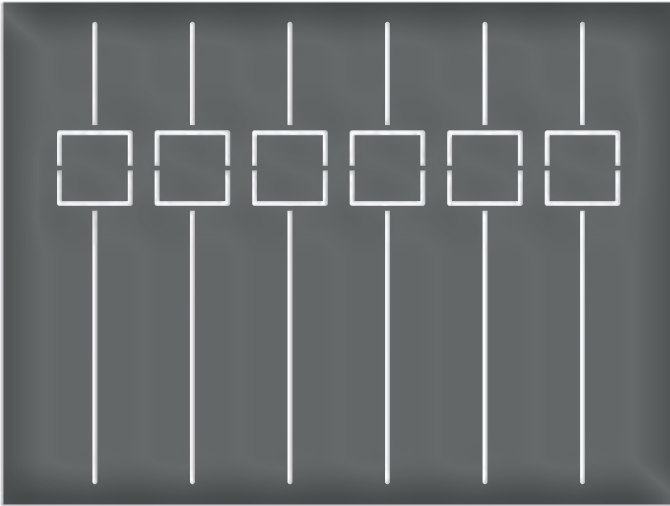

NEW

ART. QUA 08

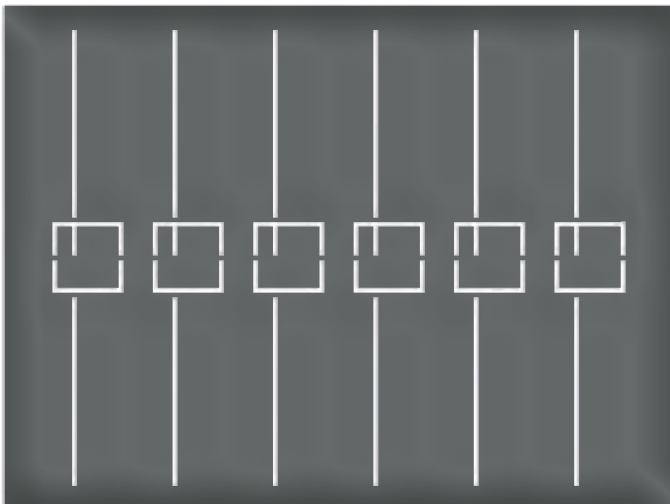

NEW

ART. QUA 09

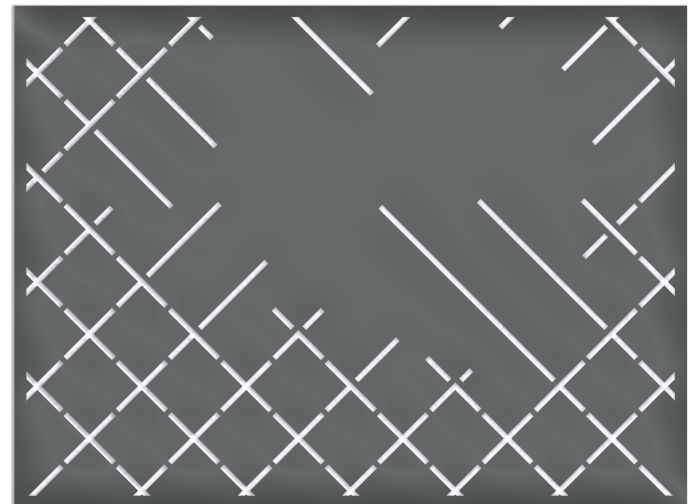

NEW

ART. QUA 10

La fattibilità della realizzazione del decoro va verificata in base a dimensioni e spessori della lastra. / The feasibility of making certain decorations may depend on plate size and thickness.  
Tutte le parti di questo catalogo - foto comprese - sono di proprietà Euro-Fer. La riproduzione, anche parziale, è vietata in ogni forma e con ogni mezzo. / Every part of this catalogue - photos included - is Euro-Fer's property. All forms of copying are strictly prohibited.

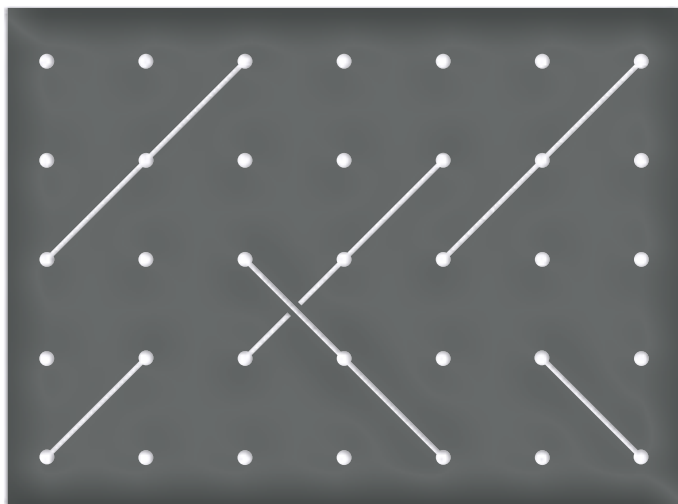

ART. SAR 01

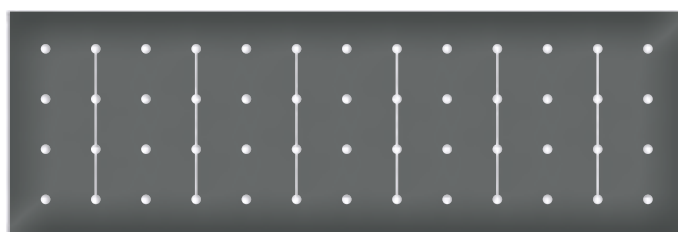

ART. SAR 06



LINEA SIDUS LINE



ART. SID 05

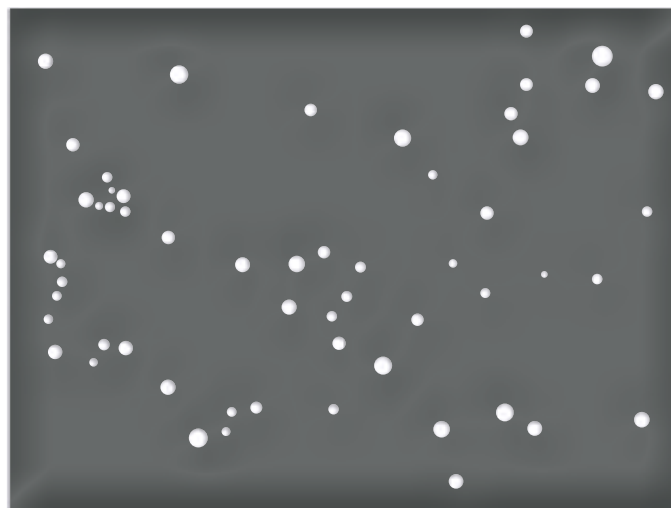

ART. SID 13

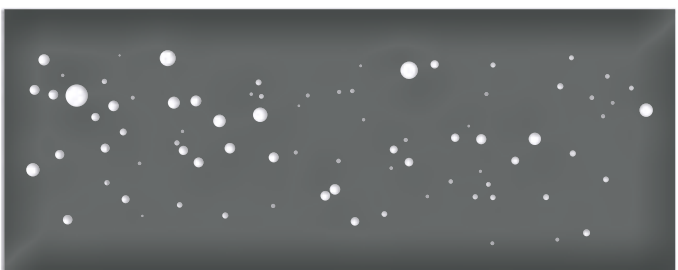

ART. SID 08

La fattibilità della realizzazione del decoro va verificata in base a dimensioni e spessori della lastra. / The feasibility of making certain decorations may depend on plate size and thickness.  
Tutte le parti di questo catalogo - foto comprese - sono di proprietà Euro-Fer. La riproduzione, anche parziale, è vietata in ogni forma e con ogni mezzo. / Every part of this catalogue - photos included - is Euro-Fer's property. All forms of copying are strictly prohibited.



ART. RAM 01

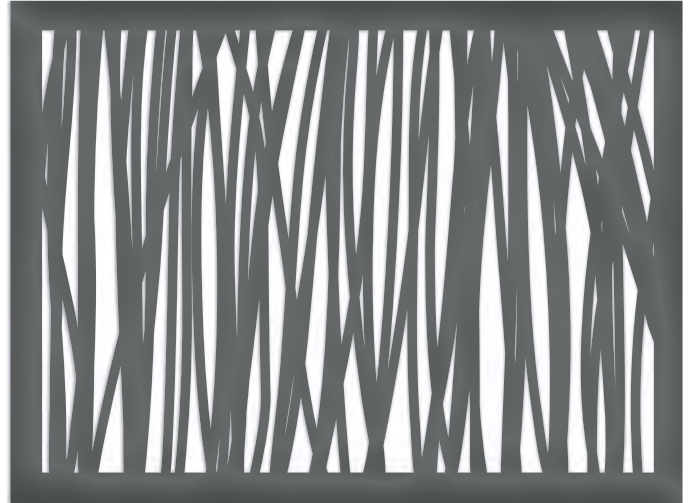

ART. RAM 02

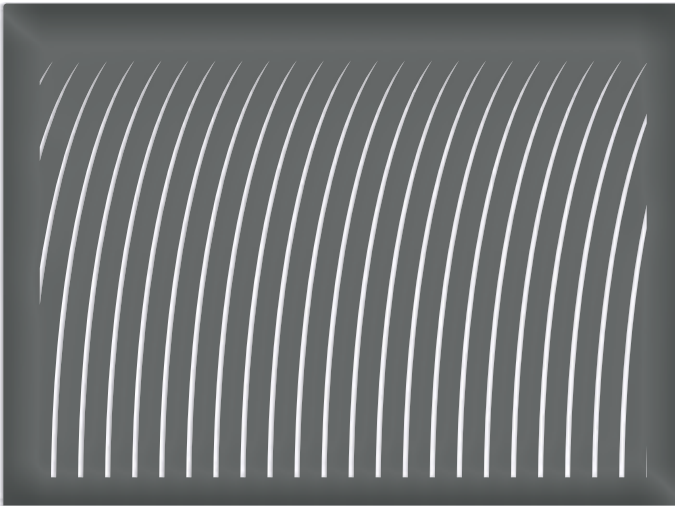

ART. RAM 03

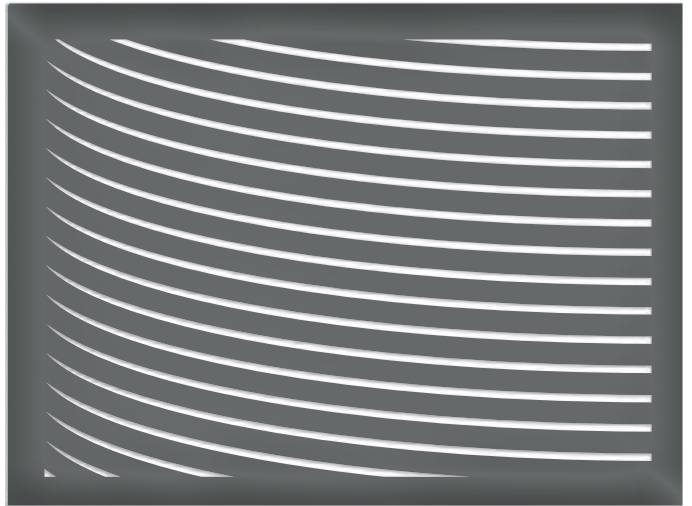

ART. RAM 04

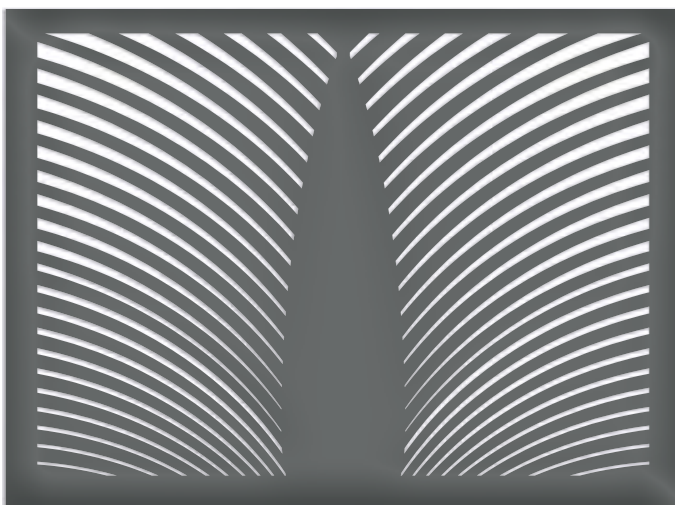

ART. RAM 05

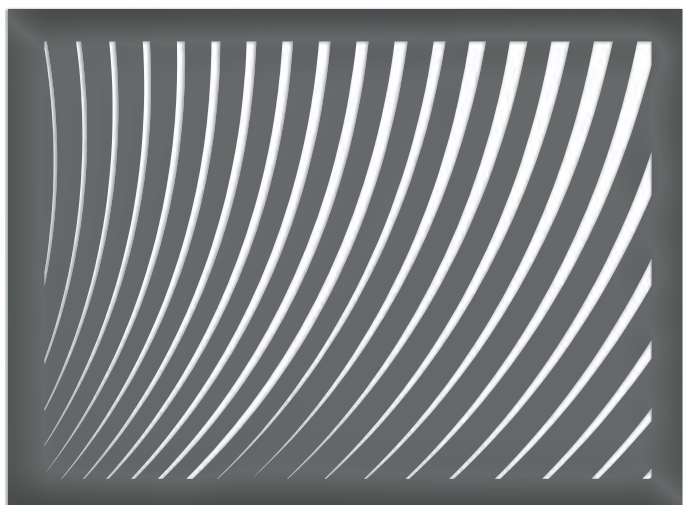

ART. RAM 06

La fattibilità della realizzazione del decoro va verificata in base a dimensioni e spessori della lastra. / The feasibility of making certain decorations may depend on plate size and thickness.

Tutte le parti di questo catalogo - foto comprese - sono di proprietà Euro-Fer. La riproduzione, anche parziale, è vietata in ogni forma e con ogni mezzo. / Every part of this catalogue - photos included - is Euro-Fer's property. All forms of copying are strictly prohibited.





La fattibilità della realizzazione del decoro va verificata in base a dimensioni e spessori della lastra. / The feasibility of making certain decorations may depend on plate size and thickness.  
Tutte le parti di questo catalogo - foto comprese - sono di proprietà Euro-Fer. La riproduzione, anche parziale, è vietata in ogni forma e con ogni mezzo. / Every part of this catalogue - photos included - is Euro-Fer's property. All forms of copying are strictly prohibited.



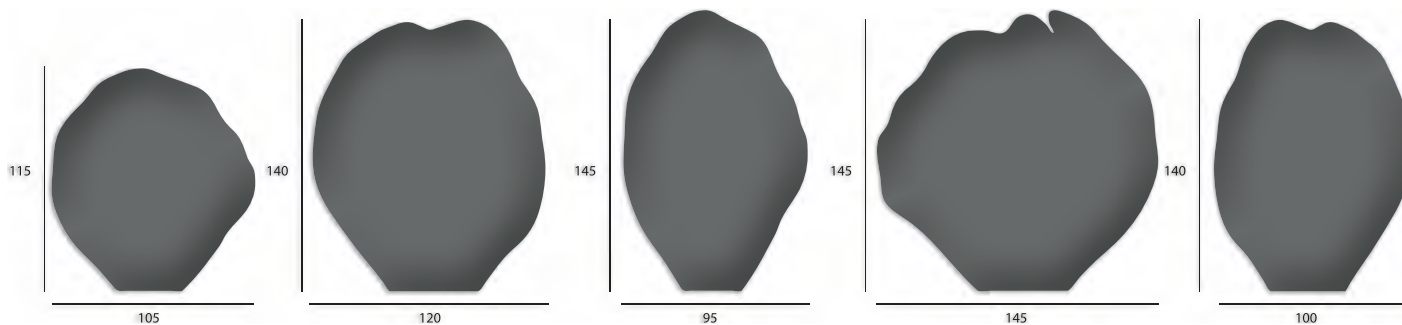

ART. PET 01

ART. PET 02

ART. PET 03

ART. PET 04

ART. PET 05

Petalis è un sistema modulare che può essere impiegato per dividere gli spazi, per creare zone indoor e outdoor, come parti di recinzioni, balaustre. I petali si possono utilizzare sovrapposti, accostati o intervallati da altri elementi del catalogo Eurofer.

*Petalis is a modular system that can be used to divide spaces, to create indoor and outdoor areas, such as parts of fences, balustrades. The petals can be used superimposed, juxtaposed or interspersed with other elements of the Eurofer catalog.*



La fattibilità della realizzazione del decoro va verificata in base a dimensioni e spessori della lastra. / The feasibility of making certain decorations may depend on plate size and thickness.

Tutte le parti di questo catalogo - foto comprese - sono di proprietà Euro-Fer. La riproduzione, anche parziale, è vietata in ogni forma e con ogni mezzo. / Every part of this catalogue - photos included - is Euro-Fer's property. All forms of copying are strictly prohibited.









ART. PRO 01



ART. PRO 04

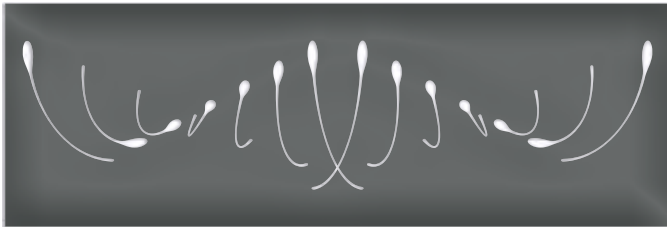

ART. PRO 02

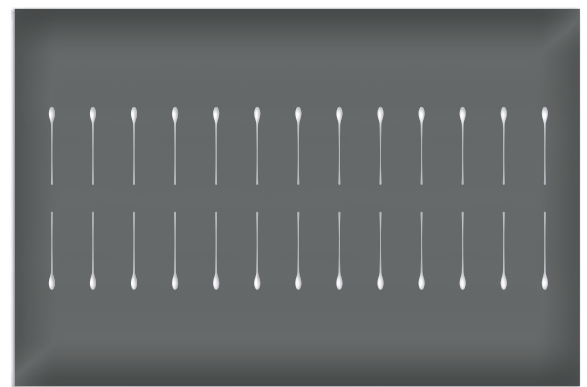

ART. PRO 05

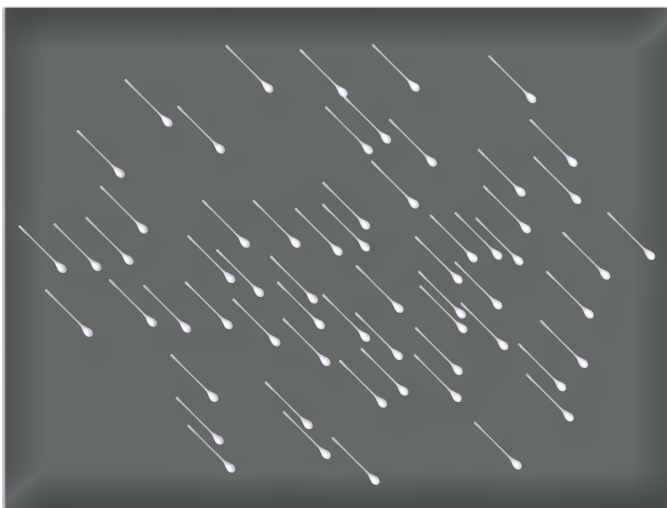

ART. PRO 03

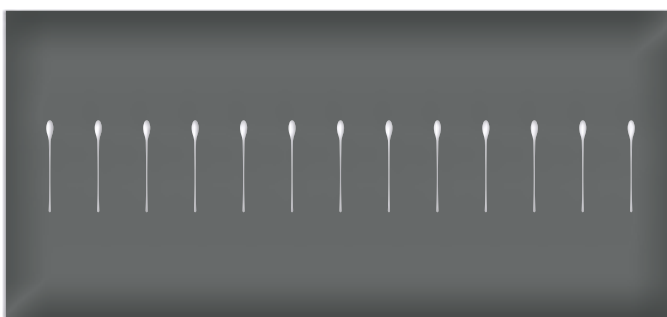

ART. PRO 06



La fattibilità della realizzazione del decoro va verificata in base a dimensioni e spessori della lastra. / The feasibility of making certain decorations may depend on plate size and thickness.

Tutte le parti di questo catalogo - foto comprese - sono di proprietà Euro-Fer. La riproduzione, anche parziale, è vietata in ogni forma e con ogni mezzo. / Every part of this catalogue - photos included - is Euro-Fer's property. All forms of copying are strictly prohibited.



ART. PRO 07

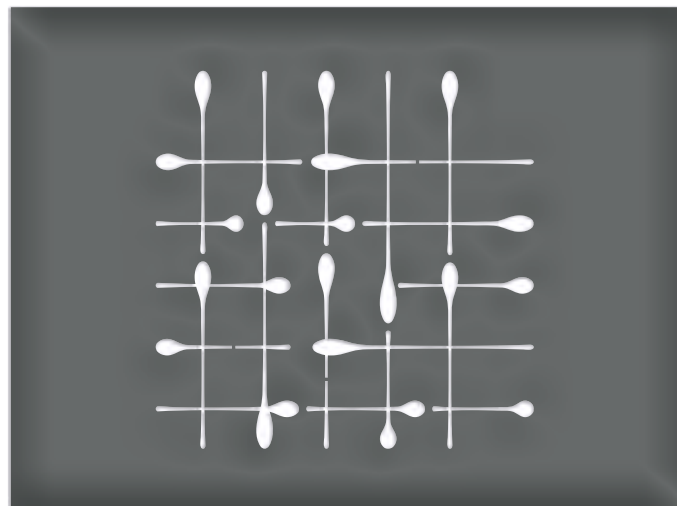

ART. PRO 11

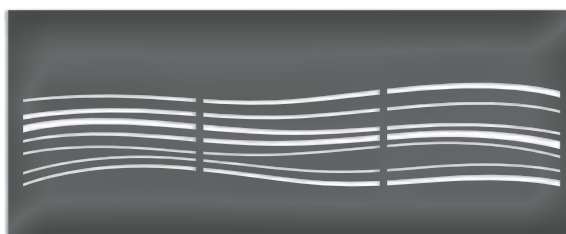

ART. PRO 08

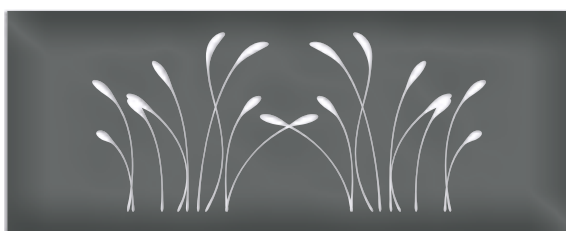

ART. PRO 10



ART. PRO 13



La fattibilità della realizzazione del decoro va verificata in base a dimensioni e spessori della lastra. / The feasibility of making certain decorations may depend on plate size and thickness.  
Tutte le parti di questo catalogo - foto comprese - sono di proprietà Euro-Fer. La riproduzione, anche parziale, è vietata in ogni forma e con ogni mezzo. / Every part of this catalogue - photos included - is Euro-Fer's property. All forms of copying are strictly prohibited.



ART. ROS 01

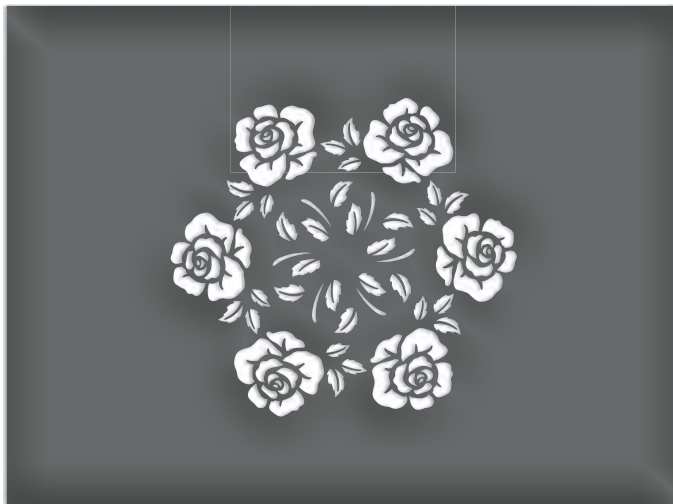

ART. ROS 02



ART. ROS 03



ART. ROS 04

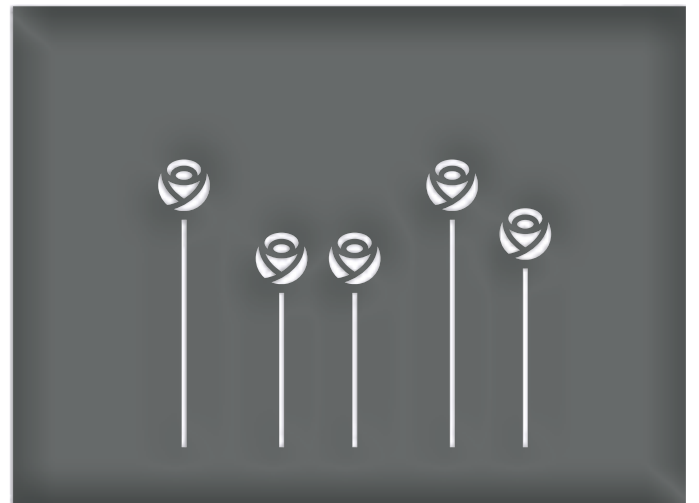

ART. ROS 05

La fattibilità della realizzazione del decoro va verificata in base a dimensioni e spessori della lastra. / The feasibility of making certain decorations may depend on plate size and thickness.

Tutte le parti di questo catalogo - foto comprese - sono di proprietà Euro-Fer. La riproduzione, anche parziale, è vietata in ogni forma e con ogni mezzo. / Every part of this catalogue - photos included - is Euro-Fer's property. All forms of copying are strictly prohibited.





ART. PHY 01



ART. PHY 02



ART. PHY 03



ART. PHY 04

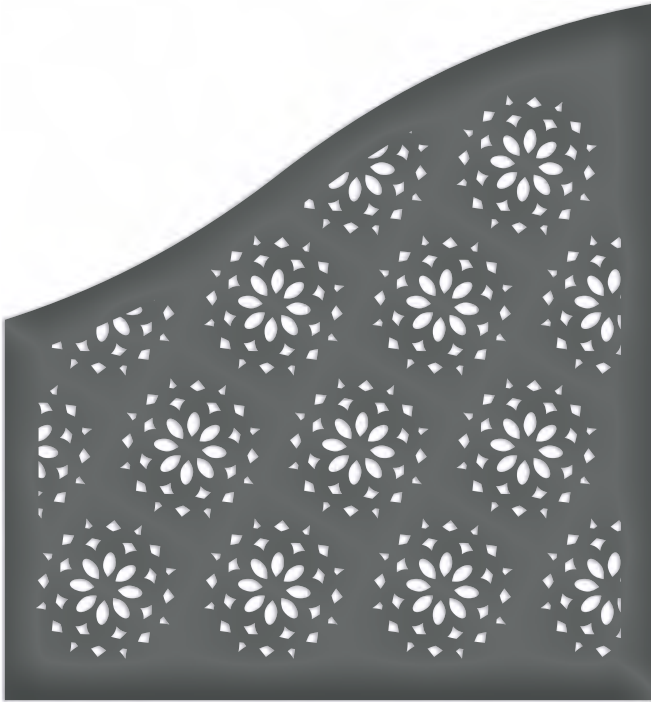
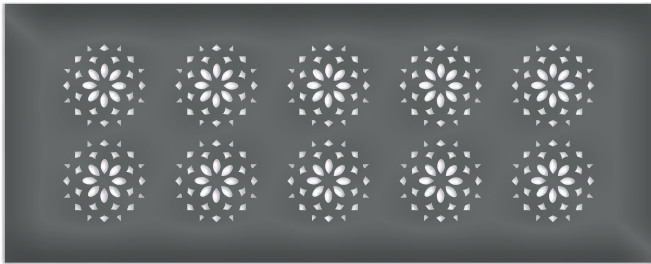
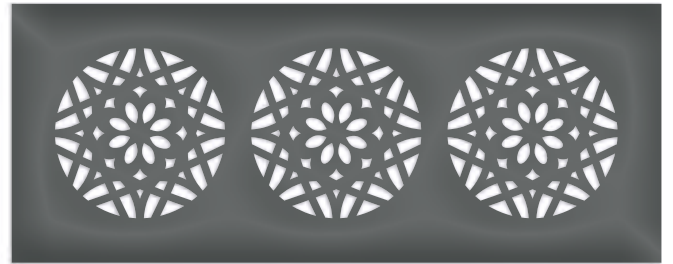

La fattibilità della realizzazione del decoro va verificata in base a dimensioni e spessori della lastra. / The feasibility of making certain decorations may depend on plate size and thickness.  
Tutte le parti di questo catalogo - foto comprese - sono di proprietà Euro-Fer. La riproduzione, anche parziale, è vietata in ogni forma e con ogni mezzo. / Every part of this catalogue - photos included - is Euro-Fer's property. All forms of copying are strictly prohibited.

ART. **AST 01**ART. **AST 02**ART. **AST 05**ART. **AST 06**

La fattibilità della realizzazione del decoro va verificata in base a dimensioni e spessori della lastra. / The feasibility of making certain decorations may depend on plate size and thickness.

Tutte le parti di questo catalogo - foto comprese - sono di proprietà Euro-Fer. La riproduzione, anche parziale, è vietata in ogni forma e con ogni mezzo. / Every part of this catalogue - photos included - is Euro-Fer's property. All forms of copying are strictly prohibited.

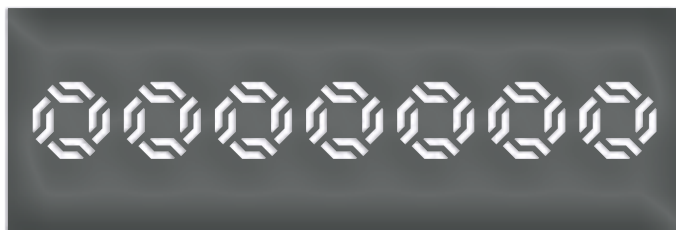

ART. OTT 02

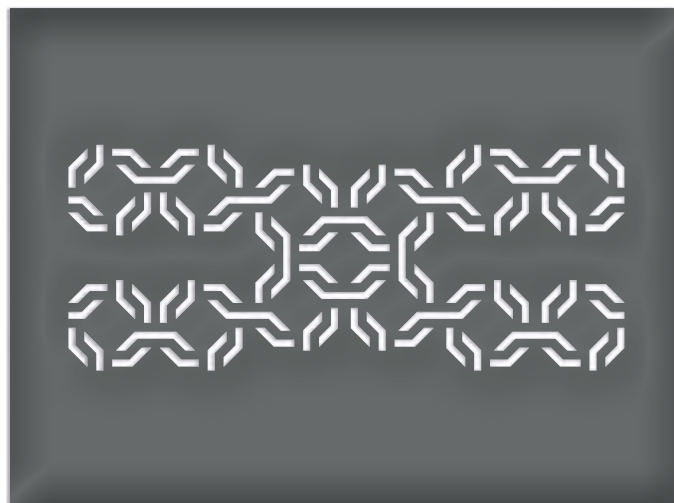

ART. OTT 03



ART. OTT 04



ART. OTT 07



ART. OTT 08

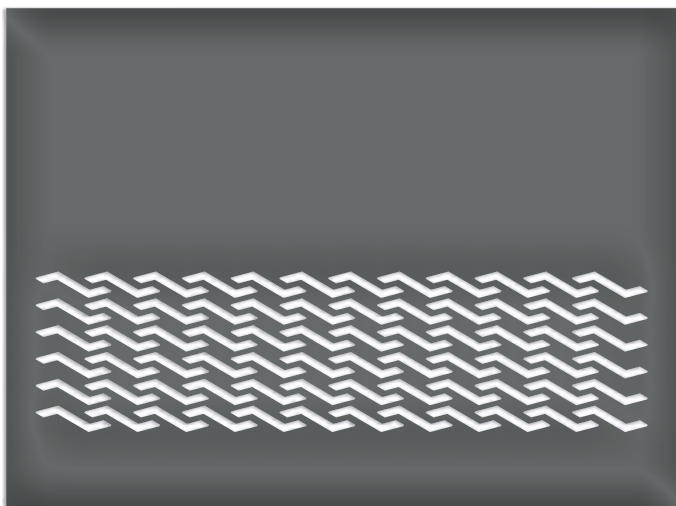

ART. OTT 11

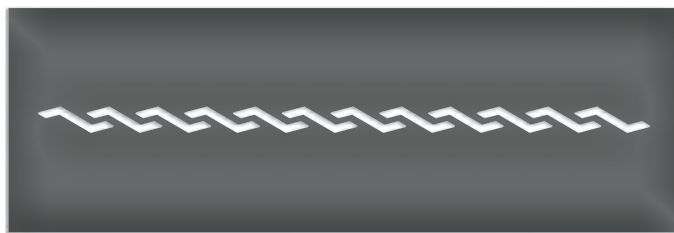

ART. OTT 12

La fattibilità della realizzazione del decoro va verificata in base a dimensioni e spessori della lastra. / The feasibility of making certain decorations may depend on plate size and thickness.  
Tutte le parti di questo catalogo - foto comprese - sono di proprietà Euro-Fer. La riproduzione, anche parziale, è vietata in ogni forma e con ogni mezzo. / Every part of this catalogue - photos included - is Euro-Fer's property. All forms of copying are strictly prohibited.





ART. CAN 01



ART. CAN 04

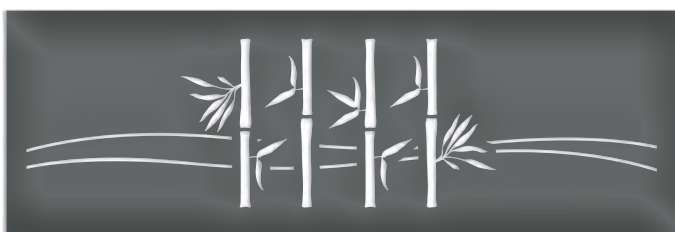

ART. CAN 02

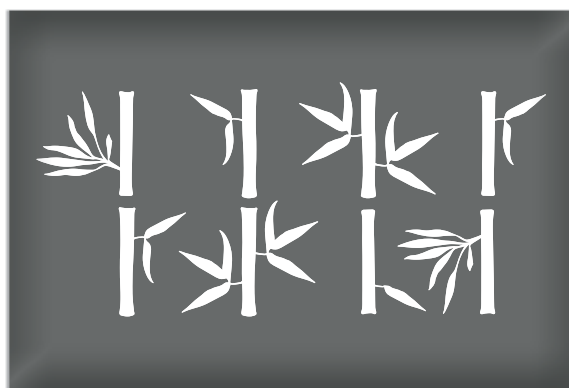

ART. CAN 05

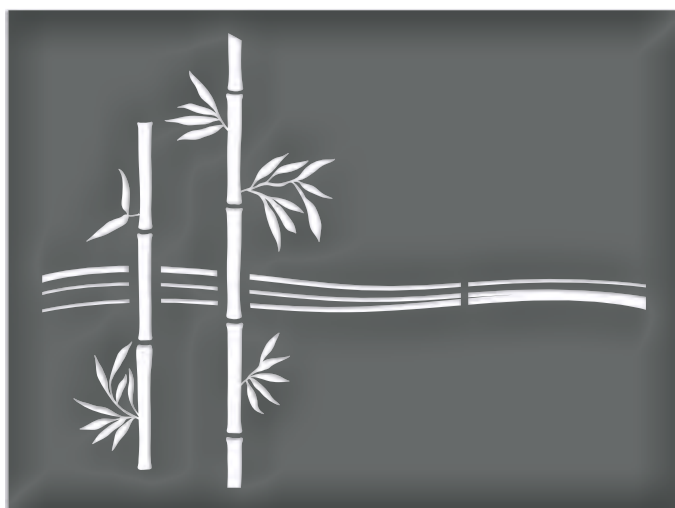

ART. CAN 03

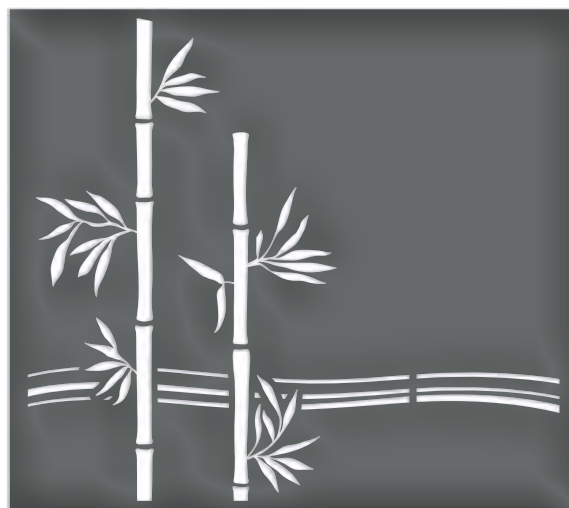

ART. CAN 07

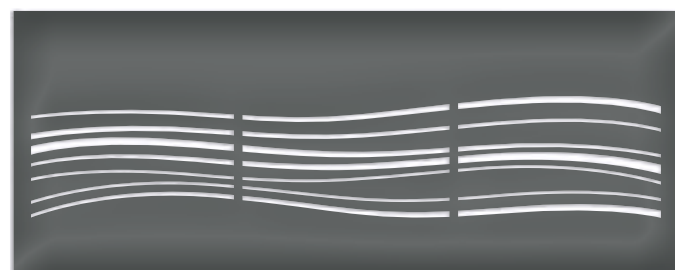

ART. CAN 08

La fattibilità della realizzazione del decoro va verificata in base a dimensioni e spessori della lastra. / The feasibility of making certain decorations may depend on plate size and thickness.

Tutte le parti di questo catalogo - foto comprese - sono di proprietà Euro-Fer. La riproduzione, anche parziale, è vietata in ogni forma e con ogni mezzo. / Every part of this catalogue - photos included - is Euro-Fer's property. All forms of copying are strictly prohibited.

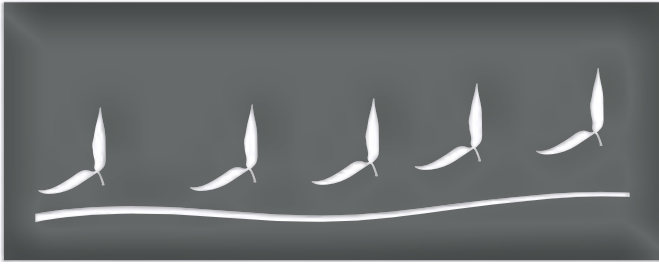

ART. CAN 09

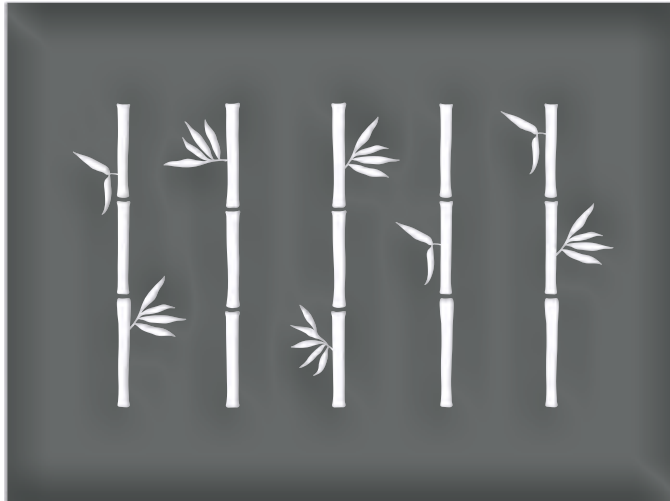

ART. CAN 11



ART. CAN 12



La fattibilità della realizzazione del decoro va verificata in base a dimensioni e spessori della lastra. / The feasibility of making certain decorations may depend on plate size and thickness.  
Tutte le parti di questo catalogo - foto comprese - sono di proprietà Euro-Fer. La riproduzione, anche parziale, è vietata in ogni forma e con ogni mezzo. / Every part of this catalogue - photos included - is Euro-Fer's property. All forms of copying are strictly prohibited.

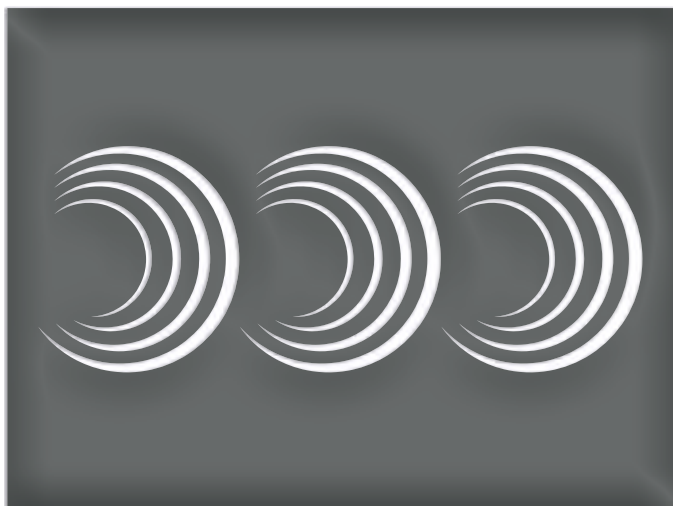

ART. SEC 01

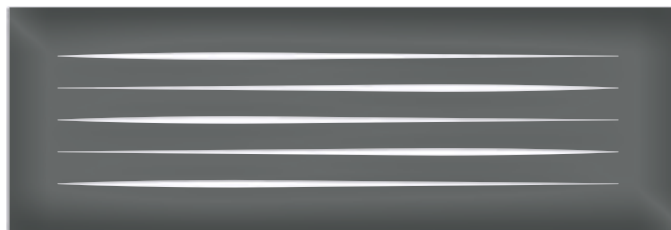

ART. SEC 02

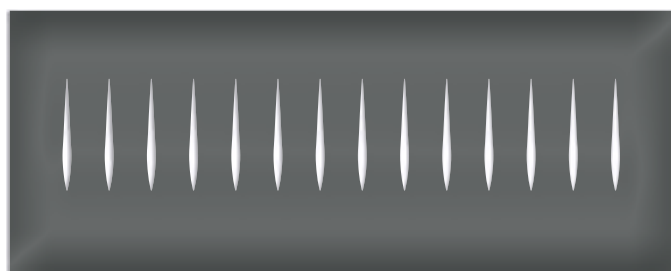

ART. SEC 08

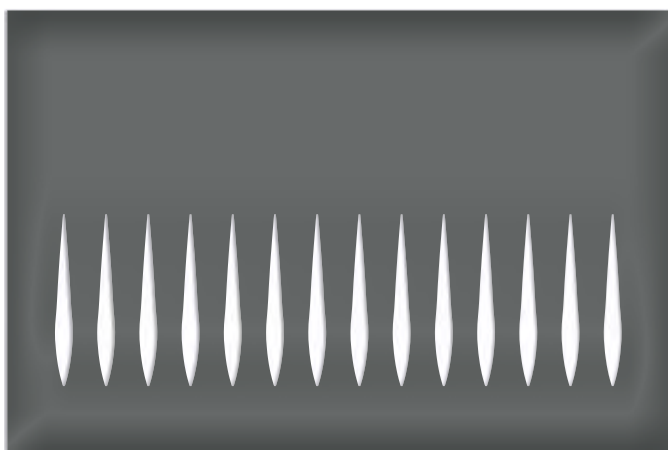

ART. SEC 05

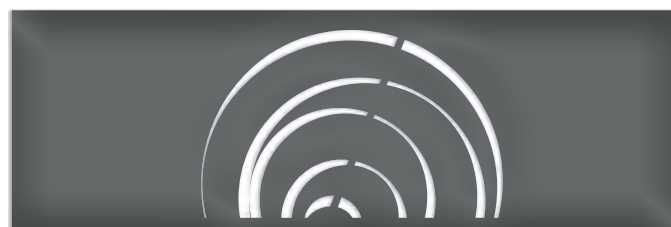

ART. SEC 12

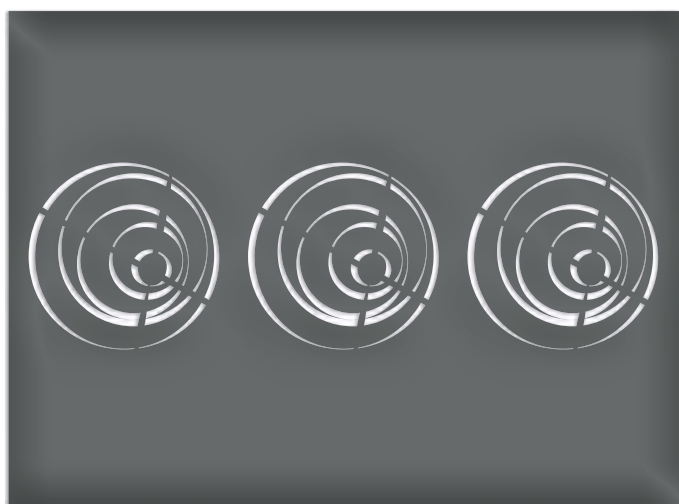

ART. SEC 11

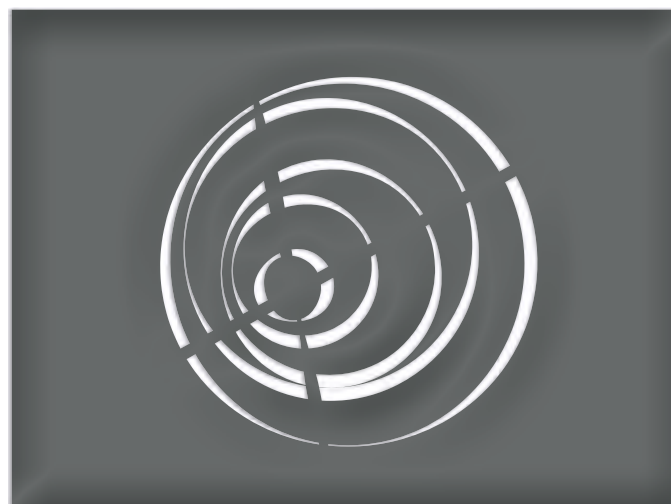

ART. SEC 13

La fattibilità della realizzazione del decoro va verificata in base a dimensioni e spessori della lastra. / The feasibility of making certain decorations may depend on plate size and thickness.

Tutte le parti di questo catalogo - foto comprese - sono di proprietà Euro-Fer. La riproduzione, anche parziale, è vietata in ogni forma e con ogni mezzo. / Every part of this catalogue - photos included - is Euro-Fer's property. All forms of copying are strictly prohibited.



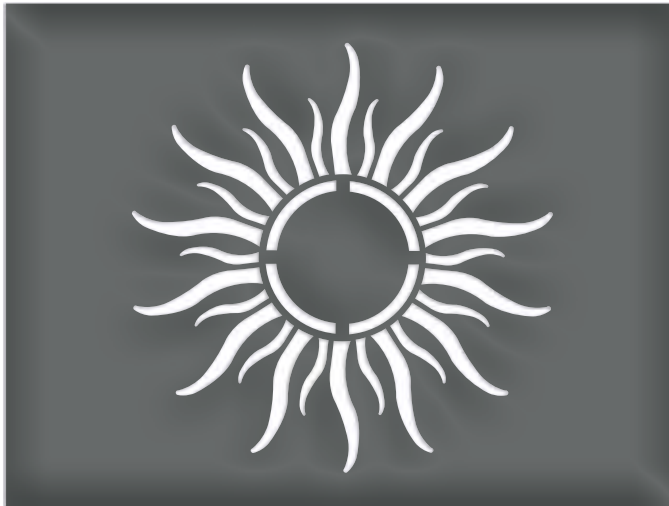

ART. SOL 01

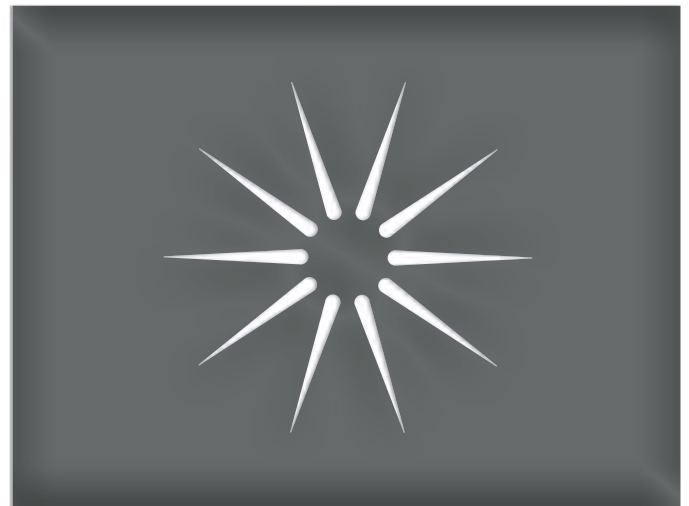

ART. SOL 02



ART. SOL 03



ART. SOL 04

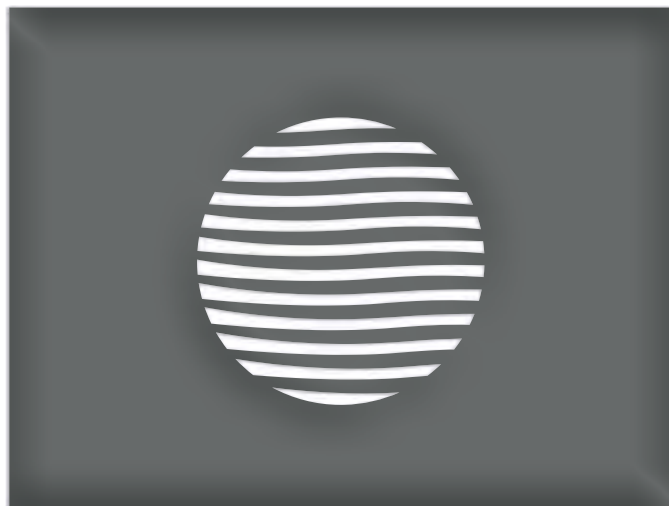

ART. SOL 05



ART. SOL 06

La fattibilità della realizzazione del decoro va verificata in base a dimensioni e spessori della lastra. / The feasibility of making certain decorations may depend on plate size and thickness.  
Tutte le parti di questo catalogo - foto comprese - sono di proprietà Euro-Fer. La riproduzione, anche parziale, è vietata in ogni forma e con ogni mezzo. / Every part of this catalogue - photos included - is Euro-Fer's property. All forms of copying are strictly prohibited.

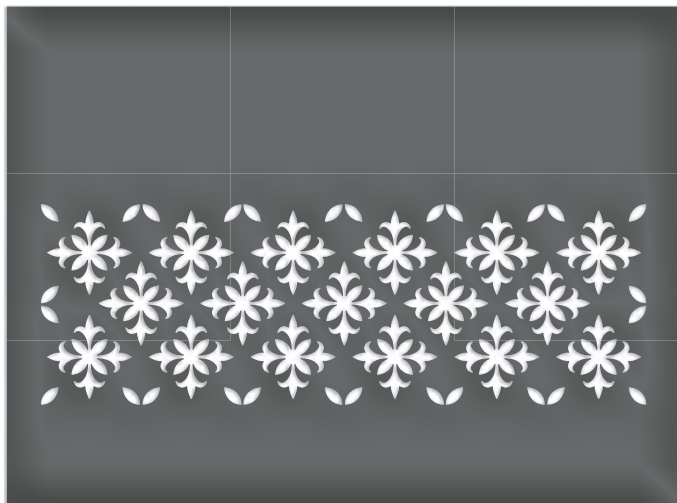

ART. ACA 01

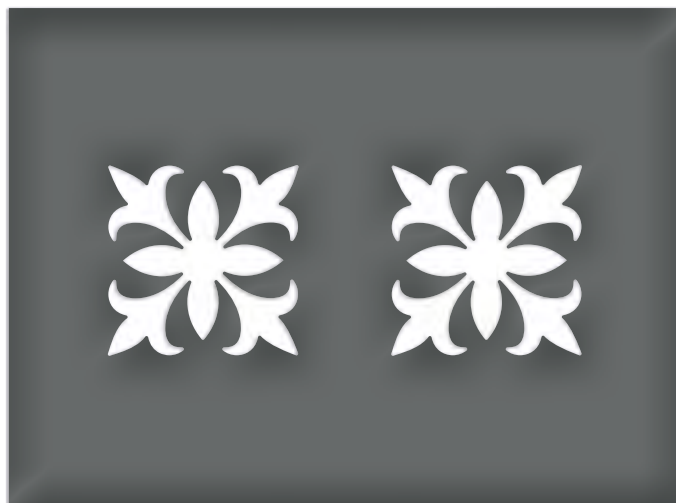

ART. ACA 02

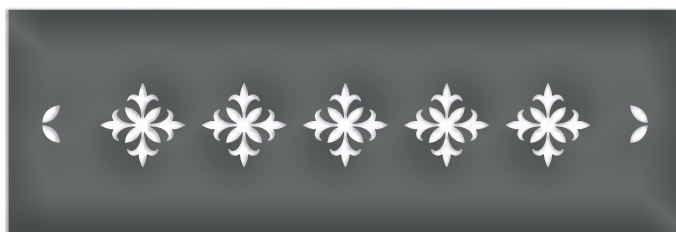

ART. ACA 03



ART. ACA 04

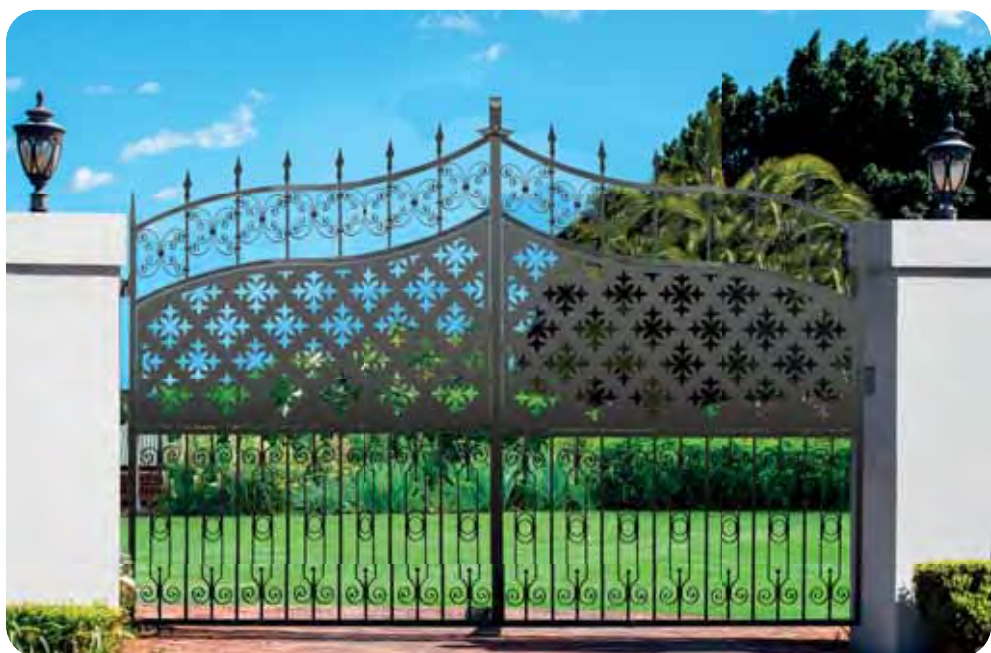

La fattibilità della realizzazione del decoro va verificata in base a dimensioni e spessori della lastra. / The feasibility of making certain decorations may depend on plate size and thickness.

Tutte le parti di questo catalogo - foto comprese - sono di proprietà Euro-Fer. La riproduzione, anche parziale, è vietata in ogni forma e con ogni mezzo. / Every part of this catalogue - photos included - is Euro-Fer's property. All forms of copying are strictly prohibited.

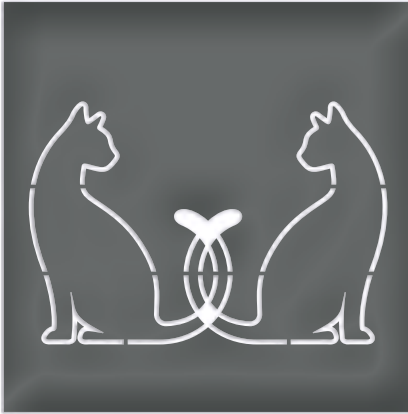

ART. CAT 01



ART. MIS 01



ART. MIS 02



ART. MIS 03

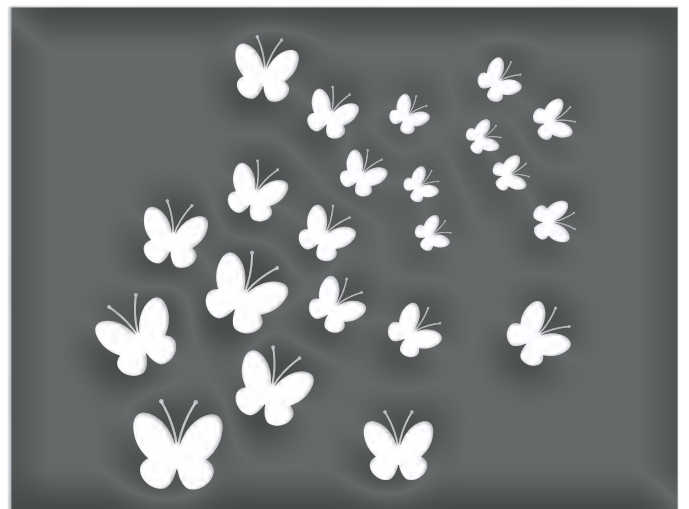

ART. MIS 05



ART. MIS 04

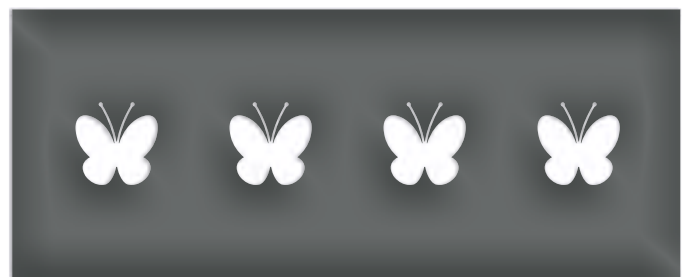

ART. MIS 06



ART. MIS 07

La fattibilità della realizzazione del decoro va verificata in base a dimensioni e spessori della lastra. / The feasibility of making certain decorations may depend on plate size and thickness.  
Tutte le parti di questo catalogo - foto comprese - sono di proprietà Euro-Fer. La riproduzione, anche parziale, è vietata in ogni forma e con ogni mezzo. / Every part of this catalogue - photos included - is Euro-Fer's property. All forms of copying are strictly prohibited.



SPESSORE / THICKNESS mm 6 - 8

- 15 -



410x330 mm  
LR001.60/10.FE  
LR001.80/10.FE

- 12,5 -



410x330 mm  
LR004.60/10.FE  
LR004.80/10.FE

- 12,5 -



410x330 mm  
LR005.60/10.FE  
LR005.80/10.FE

- 12,5 -



410x330 mm  
LR006.60/10.FE  
LR006.80/10.FE

- 15 -



430x350 mm  
LR007.60/10.FE  
LR007.80/10.FE

- 15 -



430x350 mm  
LR008.60/10.FE  
LR008.80/10.FE

- 15 -



430x350 mm  
LR009.60/10.FE  
LR009.80/10.FE

- 15 -



430x350 mm  
LR010.60/10.FE  
LR010.80/10.FE

- 15 -



430x350 mm  
LR011.60/10.FE  
LR011.80/10.FE

- 15 -



430x350 mm  
LR0110.60/10.FE  
LR0110.80/10.FE

- 15 -



430x350 mm  
LR0111.60/10.FE  
LR0111.80/10.FE

La fattibilità della realizzazione del decoro va verificata in base a dimensioni e spessori della lastra. / The feasibility of making certain decorations may depend on plate size and thickness.

Tutte le parti di questo catalogo - foto comprese - sono di proprietà Euro-Fer. La riproduzione, anche parziale, è vietata in ogni forma e con ogni mezzo. / Every part of this catalogue - photos included - is Euro-Fer's property. All forms of copying are strictly prohibited.

- 12,5 -



290x160 mm  
LR012.60/10.FE  
LR012.80/10.FE

- 12,5 -



290x160 mm  
LR013.60/10.FE  
LR013.80/10.FE

- 12,5 -



290x160 mm  
LR014.60/10.FE  
LR014.80/10.FE

- 15 -



290x160 mm  
LR015.60/10.FE  
LR015.80/10.FE

- 15 -



290x160 mm  
LR016.60/10.FE  
LR016.80/10.FE



La fattibilità della realizzazione del decoro va verificata in base a dimensioni e spessori della lastra. / The feasibility of making certain decorations may depend on plate size and thickness.  
Tutte le parti di questo catalogo - foto comprese - sono di proprietà Euro-Fer. La riproduzione, anche parziale, è vietata in ogni forma e con ogni mezzo. / Every part of this catalogue - photos included - is Euro-Fer's property. All forms of copying are strictly prohibited.

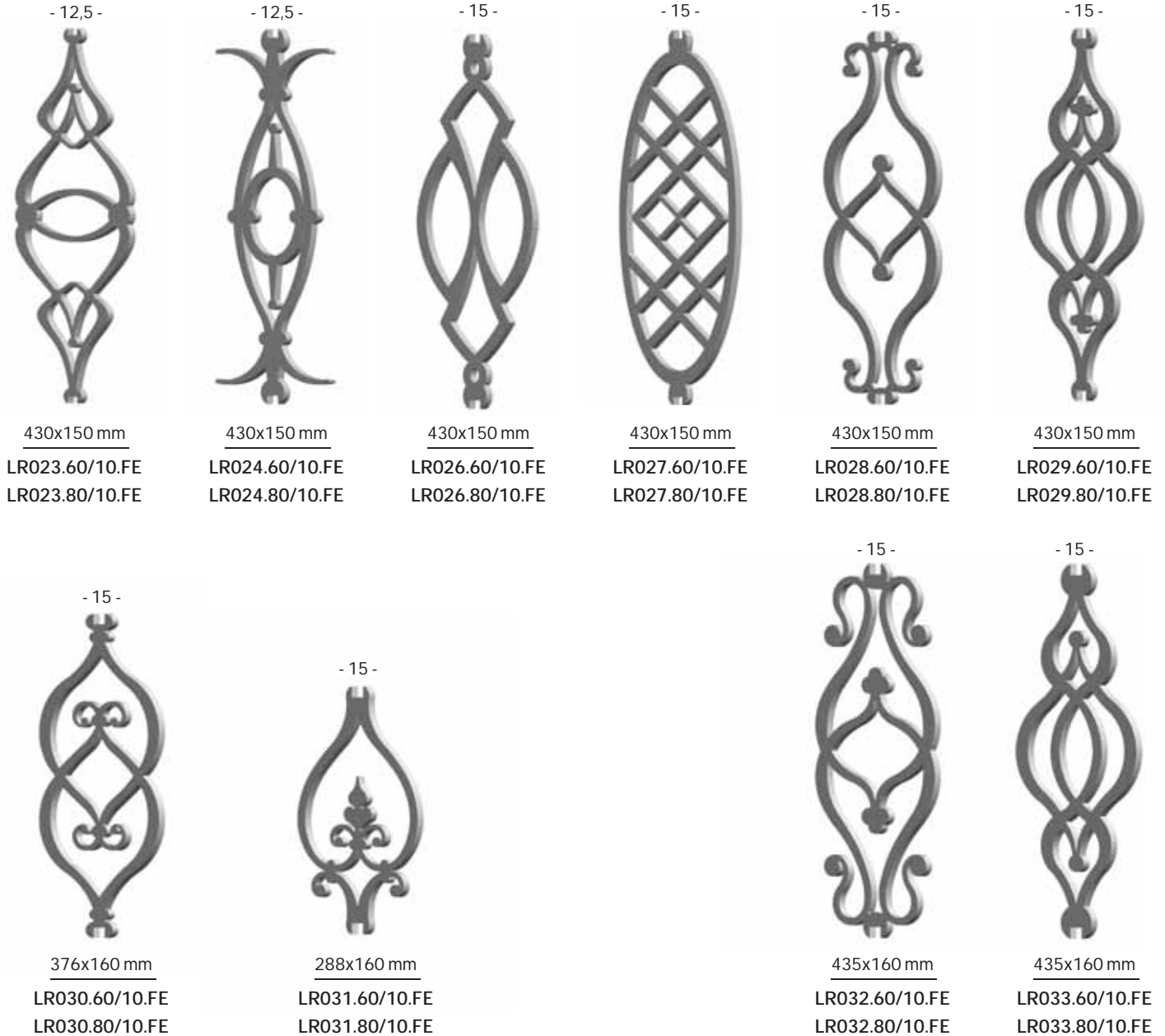

## TERMINALI ferro grezzo / POST TOPS raw iron

SPESSORE / THICKNESS mm 6 - 8

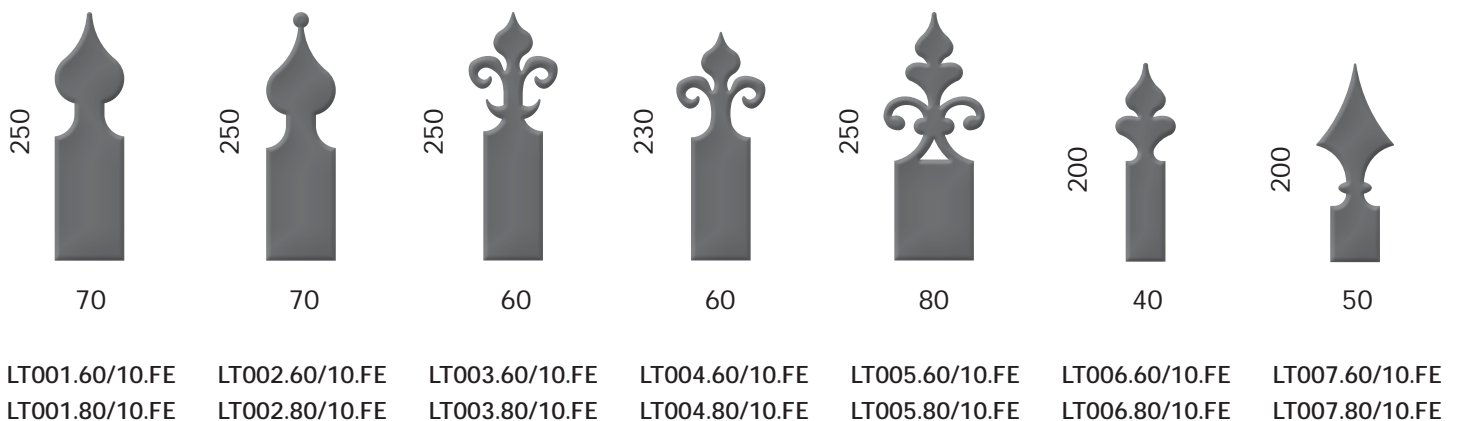

La fattibilità della realizzazione del decoro va verificata in base a dimensioni e spessori della lastra. / The feasibility of making certain decorations may depend on plate size and thickness.

Tutte le parti di questo catalogo - foto comprese - sono di proprietà Euro-Fer. La riproduzione, anche parziale, è vietata in ogni forma e con ogni mezzo. / Every part of this catalogue - photos included - is Euro-Fer's property. All forms of copying are strictly prohibited.



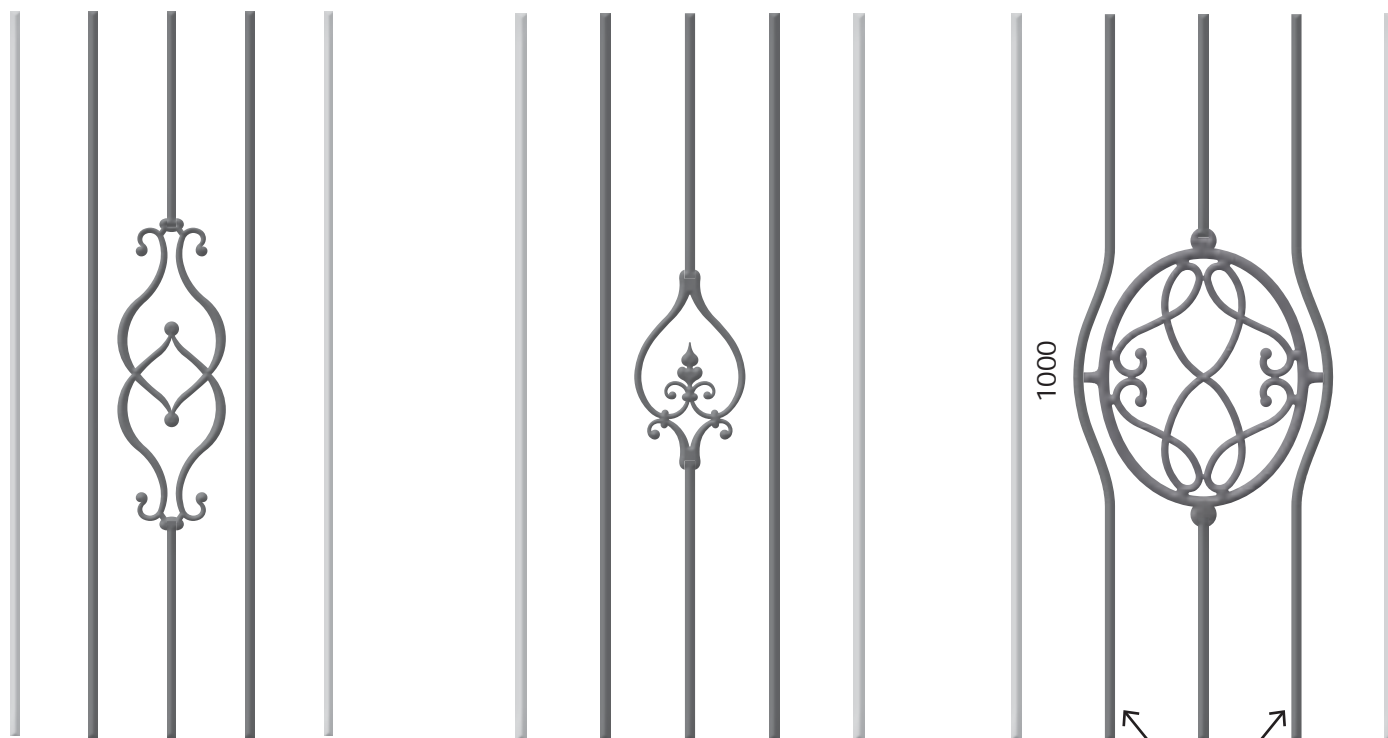

LQ12.SAG.H1000

LQ14.SAG.H1000



La fattibilità della realizzazione del decoro va verificata in base a dimensioni e spessori della lastra. / The feasibility of making certain decorations may depend on plate size and thickness.  
Tutte le parti di questo catalogo - foto comprese - sono di proprietà Euro-Fer. La riproduzione, anche parziale, è vietata in ogni forma e con ogni mezzo. / Every part of this catalogue - photos included - is Euro-Fer's property. All forms of copying are strictly prohibited.

Richiedere scheda informativa all'ufficio tecnico.  
Please contact the technical office for more information.



NEW



98

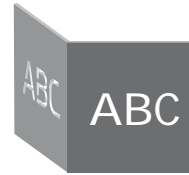

### PIASTRE PER PIANTONI ferro grezzo / BASE PLATES raw iron

SPESSORE / THICKNESS mm 4 - 6

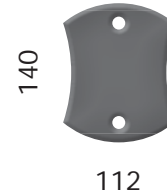
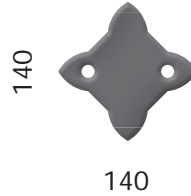
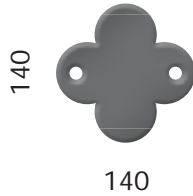
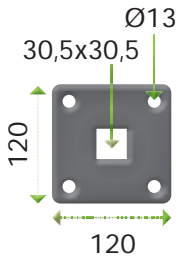

LP001.40/10.FE  
LP001.60/10.FE

LP002.40/10.FE  
LP002.60/10.FE

LP003.40/10.FE  
LP003.60/10.FE

LP004.40/10.FE  
LP004.60/10.FE

LP005.40/10.FE  
LP005.60/10.FE

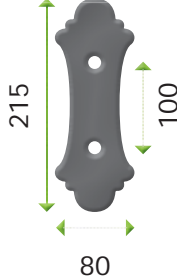
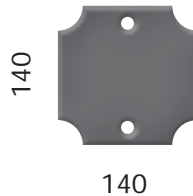
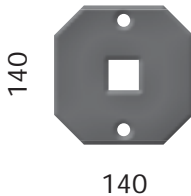

NEW

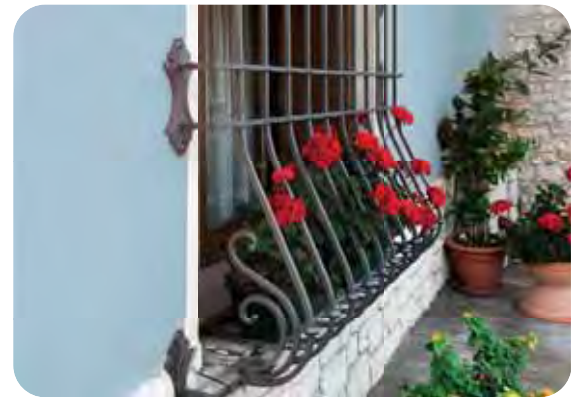

LP006.40/10.FE  
LP006.60/10.FE

LP007.40/10.FE  
LP007.60/10.FE

LP008.40/10.FE  
LP008.60/10.FE

### STAFFE DI FISSAGGIO ferro grezzo / LUGS & FIXINGS raw iron

SPESSORE / THICKNESS mm 4 - 6

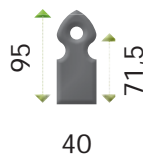
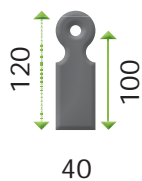

LS001.40/10.FE  
LS001.60/10.FE

LS002.40/10.FE  
LS002.60/10.FE

LS003.40/10.FE  
LS003.60/10.FE

LS004.40/10.FE  
LS004.60/10.FE

LS005.40/10.FE  
LS005.60/10.FE

LS006.40/10.FE  
LS006.60/10.FE

La fattibilità della realizzazione del decoro va verificata in base a dimensioni e spessori della lastra. / The feasibility of making certain decorations may depend on plate size and thickness.

Tutte le parti di questo catalogo - foto comprese - sono di proprietà Euro-Fer. La riproduzione, anche parziale, è vietata in ogni forma e con ogni mezzo. / Every part of this catalogue - photos included - is Euro-Fer's property. All forms of copying are strictly prohibited.



SPESSORE / THICKNESS mm 4 - 6



1000x120 mm  
 LG001.40/10.FE  
 LG001.60/10.FE



1000x100 mm  
 LG005.40/10.FE  
 LG005.60/10.FE



1200x120 mm  
 LG008.40/10.FE  
 LG008.60/10.FE



esempio / example



1200x120 mm  
 LG009.40/10.FE  
 LG009.60/10.FE



1200x100 mm  
 LG014.40/10.FE  
 LG014.60/10.FE

La fattibilità della realizzazione del decoro va verificata in base a dimensioni e spessori della lastra. / The feasibility of making certain decorations may depend on plate size and thickness.  
 Tutte le parti di questo catalogo - foto comprese - sono di proprietà Euro-Fer. La riproduzione, anche parziale, è vietata in ogni forma e con ogni mezzo. / Every part of this catalogue - photos included - is Euro-Fer's property. All forms of copying are strictly prohibited.



SPESSORE / THICKNESS mm 4 - 6

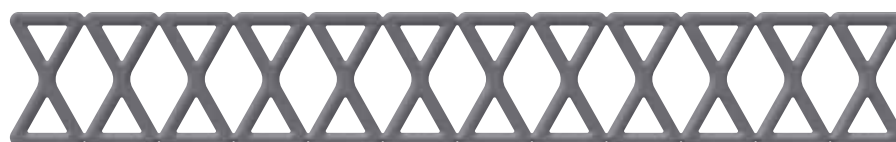
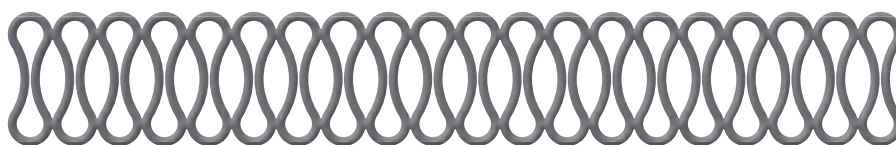
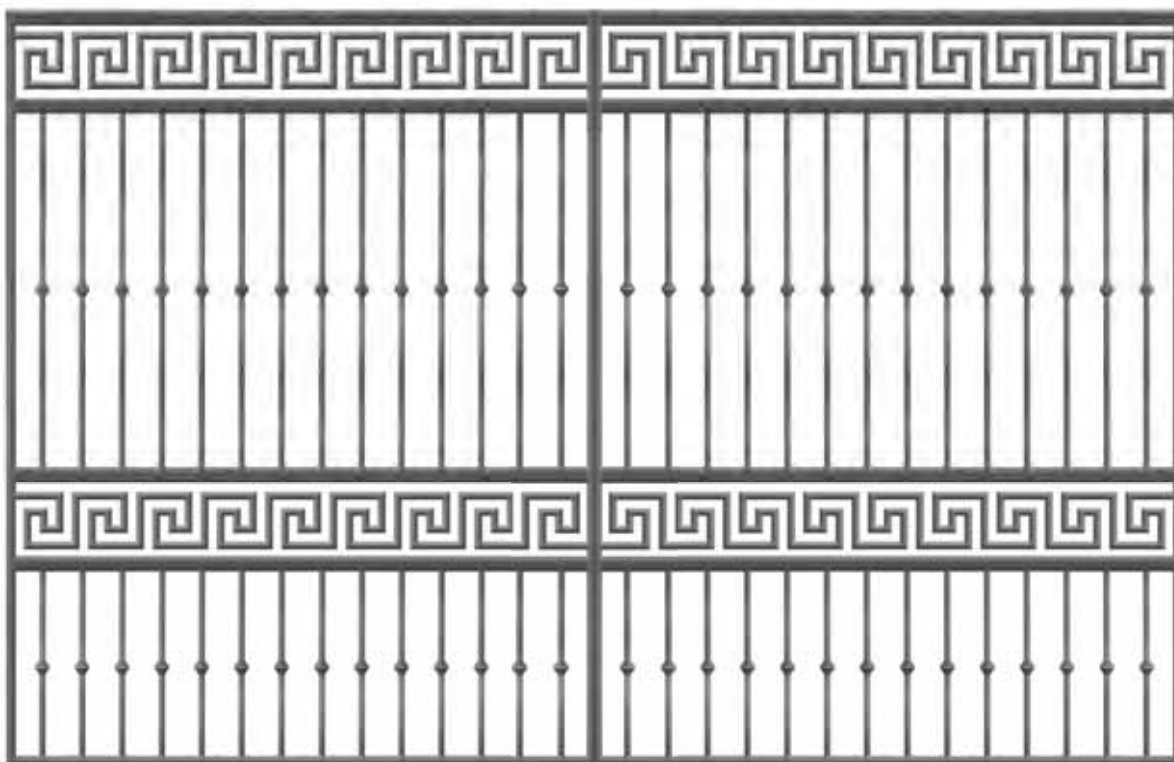

La fattibilità della realizzazione del decoro va verificata in base a dimensioni e spessori della lastra. / The feasibility of making certain decorations may depend on plate size and thickness.

Tutte le parti di questo catalogo - foto comprese - sono di proprietà Euro-Fer. La riproduzione, anche parziale, è vietata in ogni forma e con ogni mezzo. / Every part of this catalogue - photos included - is Euro-Fer's property. All forms of copying are strictly prohibited.

NEW

# CIMASE per cancelli / ORNAMENTS for carriage gates

NEW

L

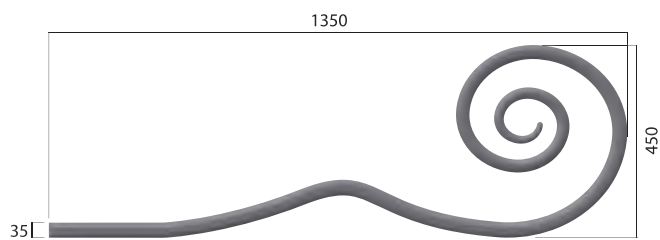

Vendute in coppia  
Sold in pairs 2 p.

LC001.40/10.FE  
LC001.60/10.FE

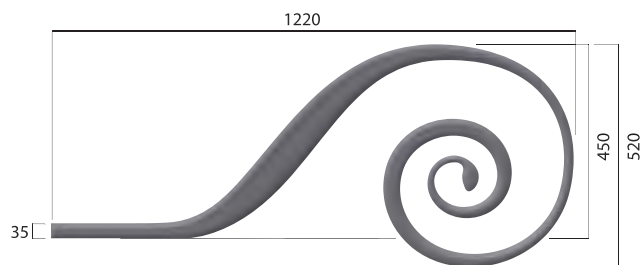

Vendute in coppia  
Sold in pairs 2 p.

LC002.40/10.FE  
LC002.60/10.FE

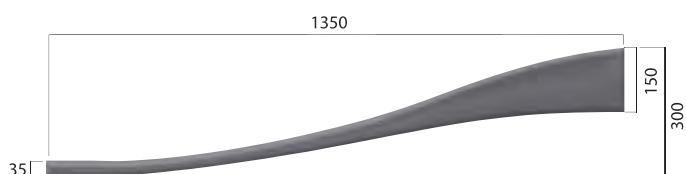

Vendute in coppia  
Sold in pairs 2 p.

LC003.40/10.FE  
LC003.60/10.FE



Vendute in coppia  
Sold in pairs 2 p.

LC004.40/10.FE  
LC004.60/10.FE

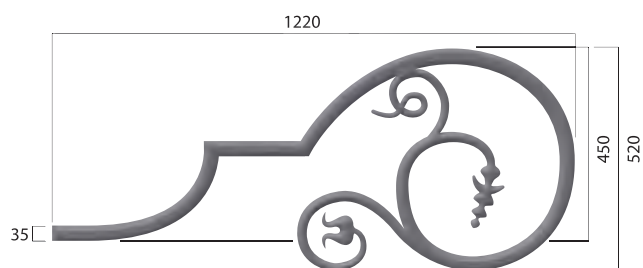

Vendute in coppia  
Sold in pairs 2 p.

LC005.40/10.FE  
LC005.60/10.FE

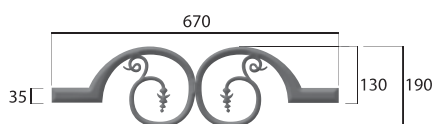

Vendute singolarmente  
Sold individually 1 p.  
LC006.40/10.FE  
LC006.60/10.FE

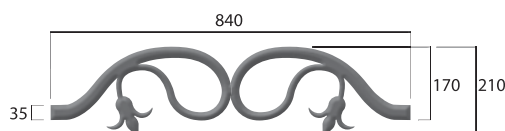

Vendute singolarmente  
Sold individually 1 p.  
LC007.40/10.FE  
LC007.60/10.FE

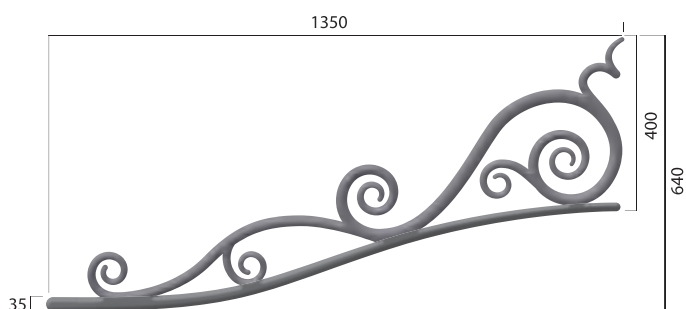

Vendute in coppia  
Sold in pairs 2 p.

LC008.40/10.FE  
LC008.60/10.FE

La fattibilità della realizzazione del decoro va verificata in base a dimensioni e spessori della lastra. / The feasibility of making certain decorations may depend on plate size and thickness.  
Tutte le parti di questo catalogo - foto comprese - sono di proprietà Euro-Fer. La riproduzione, anche parziale, è vietata in ogni forma e con ogni mezzo. / Every part of this catalogue - photos included - is Euro-Fer's property. All forms of copying are strictly prohibited.

from art. LC001.40/10.FE to art. LC008.60/10.FE

EUROFER

305

# Le linee Eurofer / Eurofer lines



FERRO BATTUTO / WROUGHT IRON



ACCIAIO INOX / STAINLESS STEEL



LASERFER



RECINZIONI / MODULAR FENCES



CANCELLI / GATES





GRADIUS ALUMINIUM

PALIXON



BAND|BOO®



ROSE COLLECTION CRYSTALS FROM SWAROVSKI®



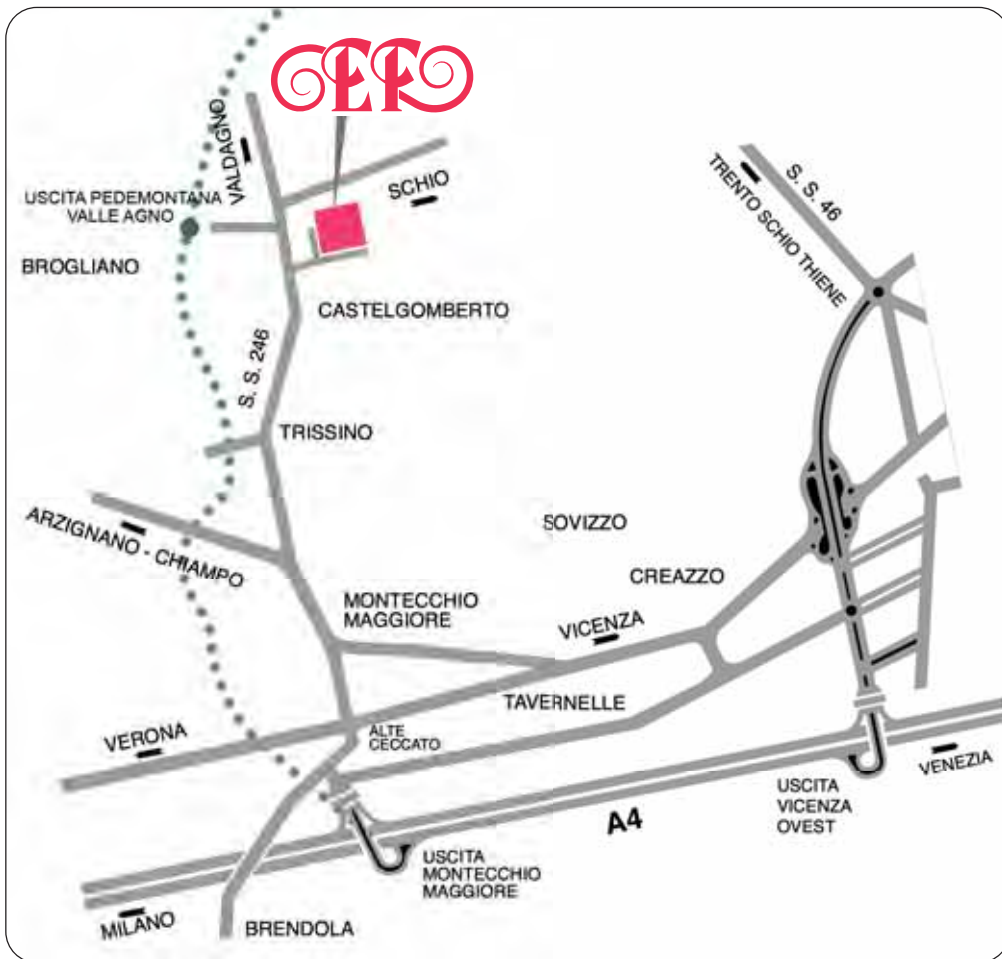

Tutte le parti di questo catalogo –foto, disegni, testi e grafica- sono di proprietà Euro-Fer®. La loro riproduzione, pubblicazione, trasmissione, duplicazione e comunicazione anche solo parziale sono vietate in ogni forma e con ogni mezzo salvo espressa autorizzazione di Euro-Fer® spa.

Dati, foto e caratteristiche tecniche non sono impegnativi. Euro-Fer® si riserva il diritto di apportare modifiche che riterrà opportune per migliorare i suoi prodotti.

Euro-Fer® è un marchio registrato. Tutti i diritti riservati.

*All the parts of this catalogue –photos, drawings, designs and texts- are Euro-Fer® spa property. Their partial or total publication, trasmission, copy, communication or other duplication are forbidden without special consent by Euro-Fer® spa.*

*Data, photos and technical characteristics are not binding. Euro-Fer® reserves the right to change the content of this catalogue without notice.*

*Euro-Fer® is a registered trademark. All rights reserved.*



Euro-Fer è un'azienda amica dell'ambiente e alimenta gran parte del ciclo produttivo con energia solare.

*Euro-Fer is an environmentally-friendly company that uses solar energy in most of its production cycle.*



# EUROFER®

LAVORAZIONE DEL FERRO BATTUTO & ACCIAIO INOX  
WROUGHT IRON & STAINLESS STEEL WORKING

## EURO-FER S.p.A.

Viale dell'Industria, 16/18  
Castelgomberto (Vicenza) Italy

tel +39 0445 440033  
fax +39 0445 440351  
e-mail eurofer@eurofer.com

 EuroFer S.P.A.  
 euroferspa  
 Euro-Fer  
Euro-Fer Rose

[www.eurofer.com](http://www.eurofer.com)



[www.rosecollection.it](http://www.rosecollection.it)







**Art. 1000**  
**Arte dal ferro / Art of wrought iron**  
 1300 articoli / articles  
 2700 variazioni di sezioni e di altezze /  
*different sections and heights*  
 50 disegni di composizioni dimostrative  
*/ design of possible creationsm*



**Art. 2000**  
**Le creazioni Euro-Fer**  
*Euro-Fer creations*  
 circa 1000 articoli / articles  
 2400 variazioni di sezioni e di altezze /  
*different sections and heights*  
 oltre 100 foto di realizzazioni / *more than*  
 100 foto of creations



**Art. 4000**  
**Le forme del ferro**  
*The shapes of iron*



**Art. 4100**  
**Tra ferro e fuoco**  
*Between iron and fire*



**Art. 5000**  
**Quaderni 01 2005**



**Art. 5001**  
**Quaderni 02 2005**



**Art. 5002**  
**Le foto**



**Art. 10000**  
**Powder coated products**



**Art. 00EZ**  
**EZ Inox**  
 Ez-inox: l'inox facile  
*Ez-inox: easy inox*

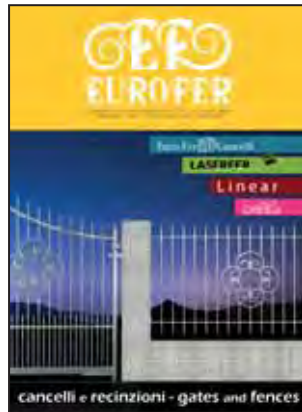

**Art. 9000**  
**Cancelli Linear e Gradius**  
 Moduli zincati pronti per  
 l'installazione *Galvanized modules*  
 ready to use



**Art. 11000**  
**Rose Collection**  
 Collezione Rose realizzata in ferro battuto  
 o in acciaio inox con inserti di cristallo,  
 utilizzo per interni. / *Indoor collection*  
 Rose, an innovative combination between  
 ornamental wrought iron, or stainless  
 steel products, made with crystal inserts.



**Art. 7003**  
**La produzione completa**  
*The whole production*



**COLLAGE.01**  
 Collage 1.0 è un'applicazione nata per  
 la creazione di composizioni grafiche  
 e la generazione della distinta relativa  
 agli articoli Euro-Fer scelti dall'archivio  
 fornito. / *Collage 1.0 is an application*  
 created to produce graphic compositions  
 using Euro-Fer's products.

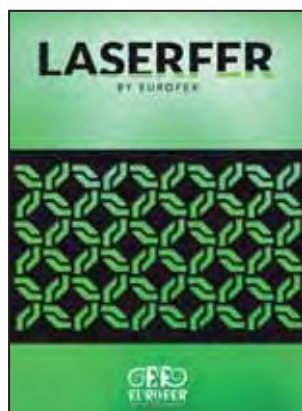

**Art. 8000**  
**Laserfer**



NEW

**LASERFFER**  
BY EUROFER

Contiene la gamma rinnovata della linea Laserfer.  
Includes the updated range of the Laserfer line.



*Hommage à la Tour Eiffel en or.  
Eurofer dédie son catalogue au monument  
en fer le plus célèbre au monde.*

*Omaggio alla Tour Eiffel in oro.  
Eurofer dedica il proprio catalogo  
al monumento in ferro più celebre al mondo.*

*Homage to the Eiffel Tower painted in gold.  
Eurofer dedicates its catalogue to the most  
famous iron monument in the world.*

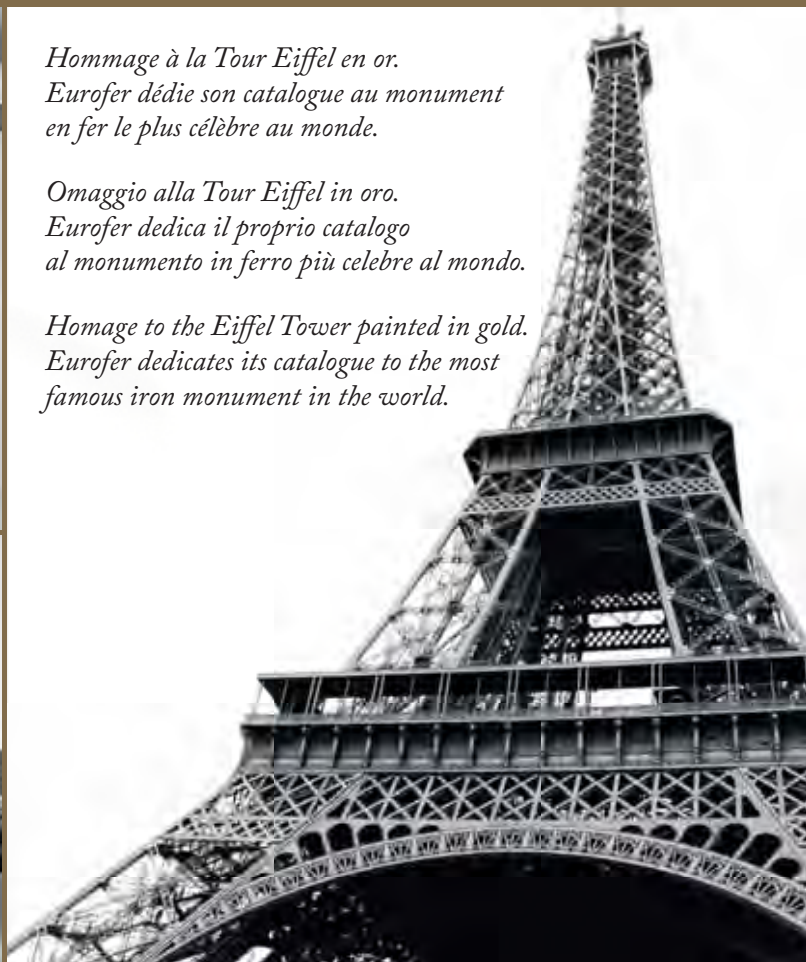

**EURO-FER S.p.A.**

Viale dell'Industria 16/18  
Castelgomberto (Vicenza)  
Telefono: +39 0445 440033  
FAX: +39 0445 440351  
E-mail: [eurofer@eurofer.com](mailto:eurofer@eurofer.com)

[www.eurofer.com](http://www.eurofer.com)

