

# LASERFER

BY EUROFER

## LASERFER TRASFORMA LE IDEE IN TAGLI DI LUCE.

Per migliorare la capacità di essere sempre al servizio del cliente, EUROFER ha deciso di ampliare la propria gamma con gli articoli tagliati al laser e con una tecnologia che permetterà ai disegni di prendere forma.

Oltre agli elementi tradizionali quali piastre, terminali ed ornamenti, sono proposti pannelli per recinzioni, per cancelli, per portali o per decoro.

Accanto alle nuove tematiche proposte dai Designers in questo catalogo, sulle superfici come il ferro, l'acciaio inossidabile e il corten si possono realizzare figure o soggetti a piacere. Il ferro della lastra può essere zincato o colorato, LASERFER propone quindi un prodotto finito e di sicuro effetto.

## LASERFER TURNS IDEAS INTO DESIGNS OF LIGHT.

To improve the capacity of always being about customer service, EUROFER has decided to extend its range with laser-cut products thanks to a technology that will allow drawings to take shape.

Besides traditional elements like plates, frets and ornaments for railings, there are also panels for enclosures, gates, portals or just for pure aesthetic.

Next to Designers' new issues in this catalogue, for what concerns surfaces like iron, stainless steel and corten, it's possible to create new figures or objects as desired.

Sheet iron can be galvanised or coloured, LASERFER proposes a finished product with a huge impact.



- 1** Scegli, nello schema della pagina seguente, i pannelli che vuoi ordinare.  
*In the pattern in the following page, choose the panels corresponding to your gate /fencing.*

ESEMPIO / EXAMPLE: CANCELLO PRINCIPALE E RECINZIONE / FRONT GATE AND FENCING

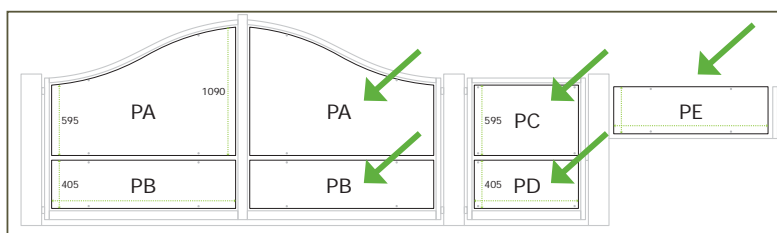

**CANCELLO PRINCIPALE:**  
 PANNELLO PA DESTRO E SINISTRO  
 PANNELLO PB DESTRO E SINISTRO  
**FRONT GATE:**  
 PANEL PA RIGHT AND LEFT  
 PANEL PB RIGHT AND LEFT

**CANCELLETTO PEDONALE:**  
 PANNELLO PC - PANNELLO PD  
**PEDESTRIAN GATE:**  
 PANEL PC - PANEL PD

**RECINZIONE: PANNELLO PE**  
**FENCING: PANEL PE**

- 2** Scegli poi il decoro nelle pagine seguenti.  
*Select the pattern in the following pages.*

ESEMPIO / EXAMPLE: PARALLELOS LINE 07 - 09 - 10

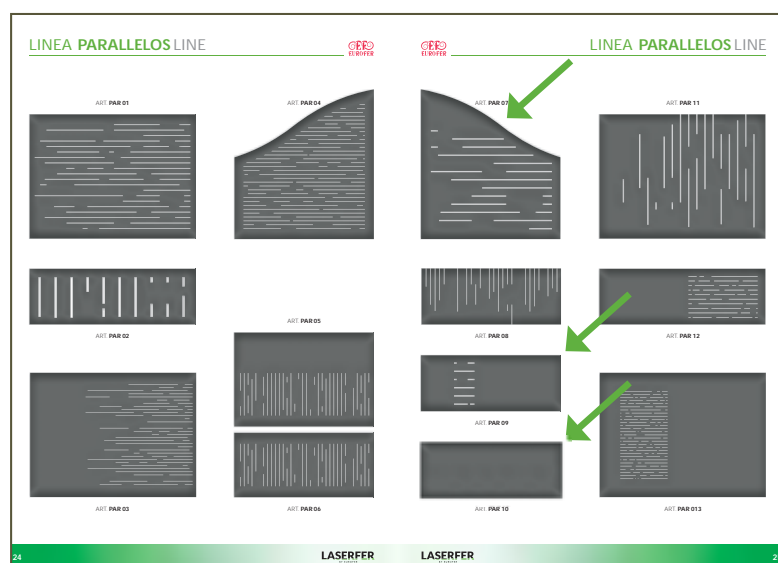

- 3** Indica poi:  
 TIPO DI PANNELLO SCELTO, DECORO E QUANTITÀ  
*Please indicate: KIND OF PANEL, DECORATION AND QUANTITY*

ESEMPIO / EXAMPLE:

PA destro / right	<b>PARALLELOS LINE 07</b>	n° 1
PA sinistro / left	<b>PARALLELOS LINE 07</b>	n° 1
PB destro / right	<b>PARALLELOS LINE 10</b>	n° 1
PB sinistro / left	<b>PARALLELOS LINE 10</b>	n° 1
PC	<b>PARALLELOS LINE 07</b>	n° 1
PD	<b>PARALLELOS LINE 10</b>	n° 1
PE	<b>PARALLELOS LINE 09</b>	n° 2

- 4** Completa il tuo ordine indicando lo spessore della lamiera, il tipo di materiale e la finitura.

*Complete your order with: thickness plate, material type and finish.*

Ed ecco visualizzato il Vostro ordine/ And now your plan:

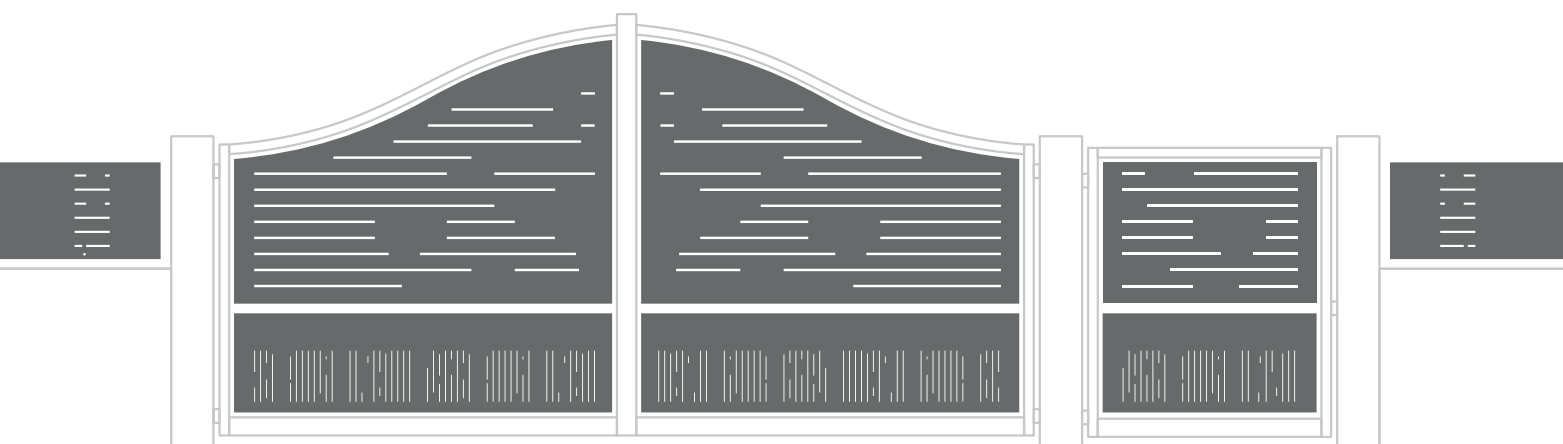

La fattibilità della realizzazione del decoro va verificata in base a dimensioni e spessori della lastra. / The feasibility of making certain decorations may depend on plate size and thickness.

Tutte le parti di questo catalogo - foto comprese - sono di proprietà Euro-Fer. La riproduzione, anche parziale, è vietata in ogni forma e con ogni mezzo. / Every part of this catalogue - photos included - is Euro-Fer's property. All forms of copying are strictly prohibited.

CODICI - DIMENSIONI / CODES - DIMENSIONS

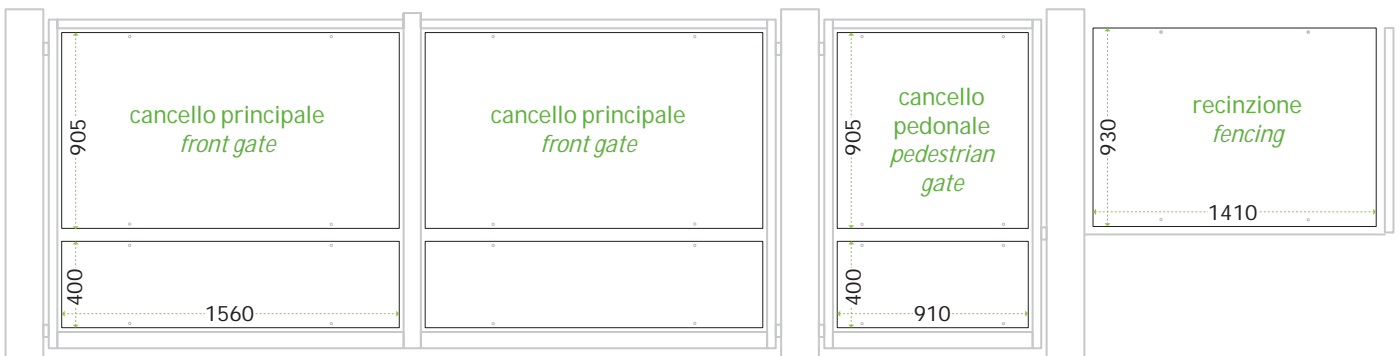
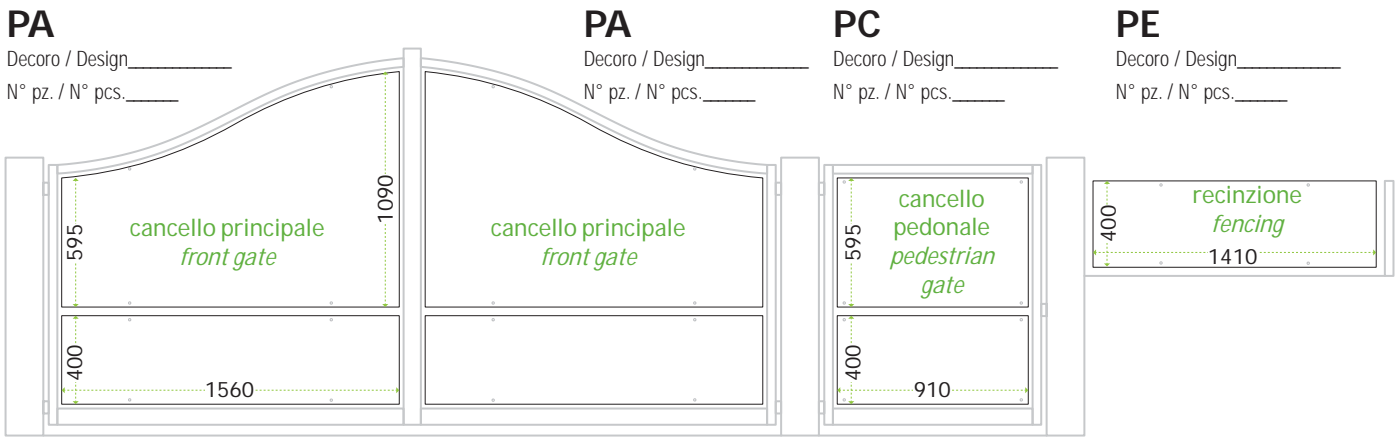

DECORAZIONE / DESIGN



Scegli i decori Laserfer  
Choose a Laserfer design



Allega il tuo file .dxf  
Send us your .dxf file



Allega il tuo disegno  
Send us your sketch

SPESSORI - MATERIALI E FINITURE / THICKNESS - MATERIALS AND FINISHING

Spessore Lamiera  
Sheet Thickness

- 20/10
- 25/10
- 30/10
- 40/10
- .....

Materiale / Material  
Finitura / Finishing

- FERRO GREZZO / RAW IRON
- PRE-ZINCATO / GALVANIZED
- PRE-ZINCATO VERNICIATO  
PRE-GALVANIZED POWDER COATED

- COR-TEN
- INOX 304
- INOX 316







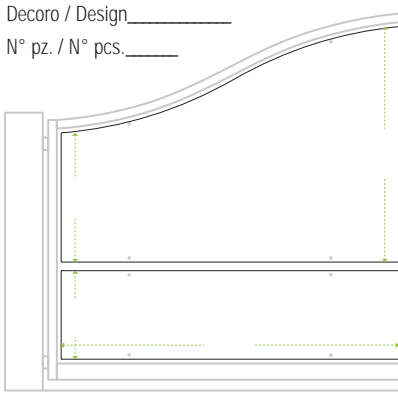
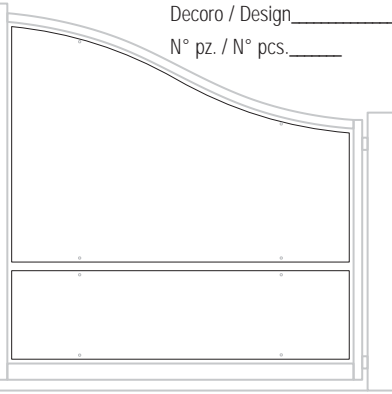
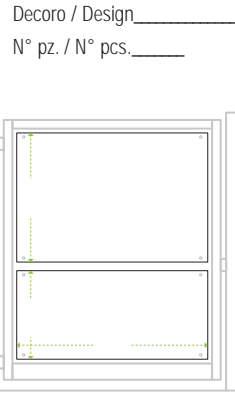
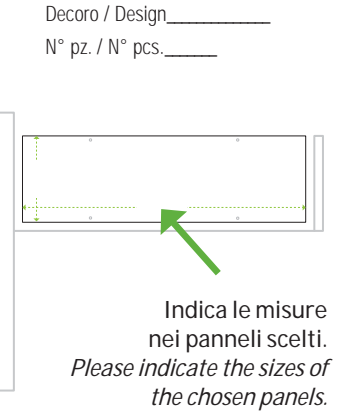
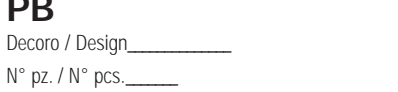
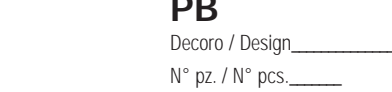

RAL.....

For specific questions regarding finish, colouring, or technical topics, please contact your local sales office.

La fattibilità della realizzazione del decoro va verificata in base a dimensioni e spessori della lastra. / The feasibility of making certain decorations may depend on plate size and thickness. Tutte le parti di questo catalogo - foto comprese - sono di proprietà Euro-Fer. La riproduzione, anche parziale, è vietata in ogni forma e con ogni mezzo. / Every part of this catalogue - photos included - is Euro-Fer's property. All forms of copying are strictly prohibited.

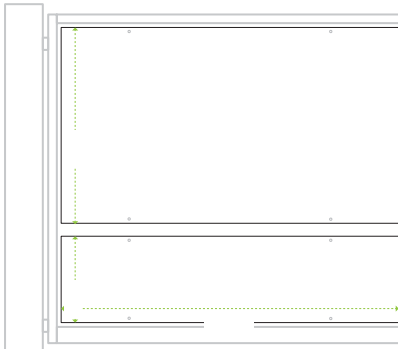
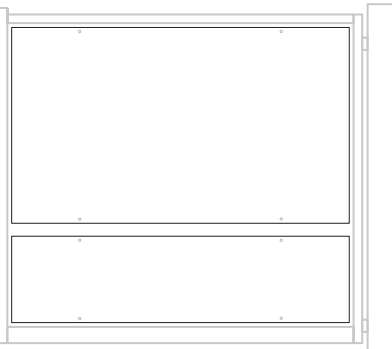
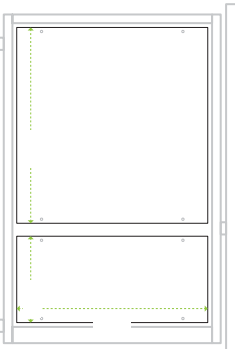
## CODICI - DIMENSIONI / CODES - DIMENSIONS

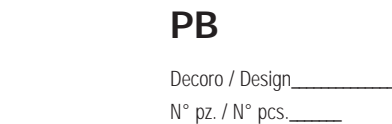
<p><b>PA</b> Decoro / Design _____ N° pz. / N° pcs. _____</p> 	<p><b>PA</b> Decoro / Design _____ N° pz. / N° pcs. _____</p> 	<p><b>PC</b> Decoro / Design _____ N° pz. / N° pcs. _____</p> 	<p><b>PE</b> Decoro / Design _____ N° pz. / N° pcs. _____</p> 
<p><b>PB</b> Decoro / Design _____ N° pz. / N° pcs. _____</p> 	<p><b>PB</b> Decoro / Design _____ N° pz. / N° pcs. _____</p> 	<p><b>PD</b> Decoro / Design _____ N° pz. / N° pcs. _____</p> 	

<p><b>PF</b> Decoro / Design _____ N° pz. / N° pcs. _____</p> 	<p><b>PF</b> Decoro / Design _____ N° pz. / N° pcs. _____</p> 	<p><b>PG</b> Decoro / Design _____ N° pz. / N° pcs. _____</p> 	<p><b>PH</b> Decoro / Design _____ N° pz. / N° pcs. _____</p> 
<p><b>PB</b> Decoro / Design _____ N° pz. / N° pcs. _____</p> 	<p><b>PB</b> Decoro / Design _____ N° pz. / N° pcs. _____</p> 	<p><b>PD</b> Decoro / Design _____ N° pz. / N° pcs. _____</p> 	

## DECORAZIONE / DESIGN



- Scegli i decori Laserfer  
Choose a Laserfer design

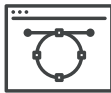

- Allega il tuo file .dxf  
Send us your .dxf file



- Allega il tuo disegno  
Send us your sketch

## SPESSORI - MATERIALI E FINITURE / THICKNESS - MATERIALS AND FINISHING

Spessore Lamiera  
Sheet Thickness

- 20/10  
 25/10  
 30/10  
 40/10  
 .....

Materiale / Material  
Finitura / Finishing

- FERRO GREZZO / RAW IRON  
 PRE-ZINCATO / GALVANIZED  
 PRE-ZINCATO VERNICIATO  
PRE-GALVANIZED POWDER COATED

- COR-TEN  
 INOX 304  
 INOX 316



RAL.....

For specific questions regarding finish, colouring, or technical topics, please contact your local sales office.

La fattibilità della realizzazione del decoro va verificata in base a dimensioni e spessori della lastra. / The feasibility of making certain decorations may depend on plate size and thickness.

Tutte le parti di questo catalogo - foto comprese - sono di proprietà Euro-Fer. La riproduzione, anche parziale, è vietata in ogni forma e con ogni mezzo. / Every part of this catalogue - photos included - is Euro-Fer's property. All forms of copying are strictly prohibited.

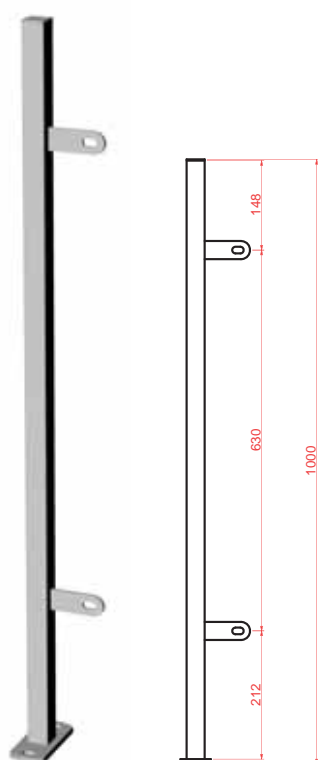

PLP 10 - H 1000 mm

Caposaldo forato con piastra di fissaggio. Comprende 2 viti M10 con dado antifurto.  
/ Drilled newel post with base plates to bolt down to concrete or walls. Includes 2 x M10 Bolts and snap off cone nuts to fix the panel to the post.

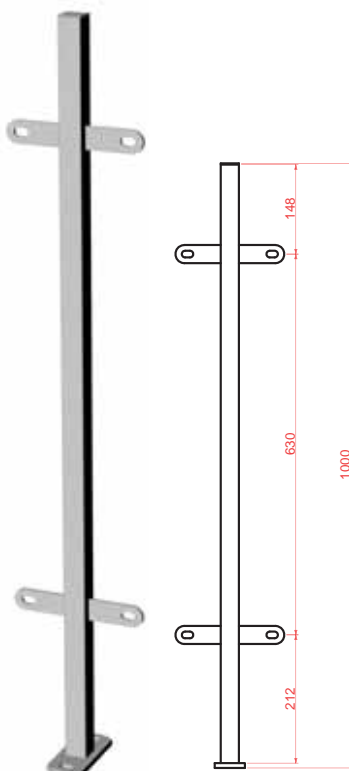

PLM 10 - H 1000 mm

Caposaldo forato con piastra di fissaggio. Comprende 4 viti M10 con dado antifurto.  
/ Drilled newel post with base plates to bolt down to concrete or walls. Includes 4 x M10 Bolts and snap off cone nuts to fix the panel to the post.

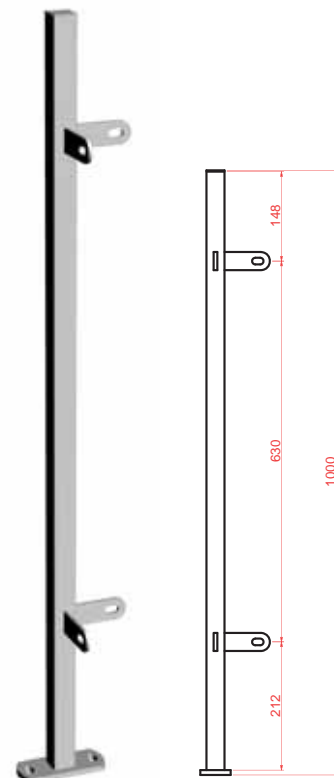

PLC 10 - H 1000 mm

Caposaldo forato con piastra di fissaggio. Comprende 4 viti M10 con dado antifurto.  
/ Drilled newel post with base plates to bolt down to concrete or walls. Includes 4 x M10 Bolts and snap off cone nuts to fix the panel to the post.

**Finiture / Finishes**

Standard: piantone zincato a caldo / galvanized post

V: piantone zincato a caldo e verniciato / galvanized and powder coated post

G: piantone grezzo / untreated post

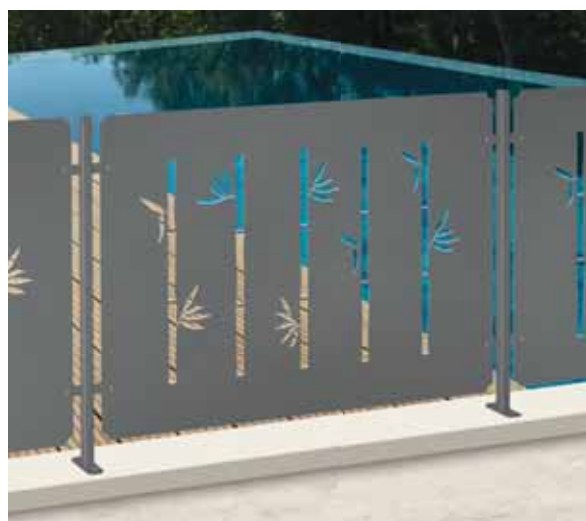

**KIT-VITI.L**

Comprende 4 viti M 10 in ferro zincato con dado antifurto.

*Includes 4 x M 10 bolts (galvanized iron) and snap-off cone nuts.*

I caposaldi della famiglia Laserfer sono zincati a caldo e vengono forniti con un set di viti M10 (KIT-VITI.L) zincate a freddo complete di dado antifurto per il fissaggio del pannello.  
*The Laserfer PANELS posts are hot galvanized, and include a set of M10 bolts (KIT-VITI.L) cold galvanized and snap-off cone nuts for fixing the panel.*

## LINEE LASERFER LINES

La fattibilità della realizzazione del decoro va verificata in base a dimensioni e spessori della lastra. / The feasibility of making certain decorations may depend on plate size and thickness.

Tutte le parti di questo catalogo - foto comprese - sono di proprietà Euro-Fer. La riproduzione, anche parziale, è vietata in ogni forma e con ogni mezzo. / Every part of this catalogue - photos included - is Euro-Fer's property. All forms of copying are strictly prohibited.

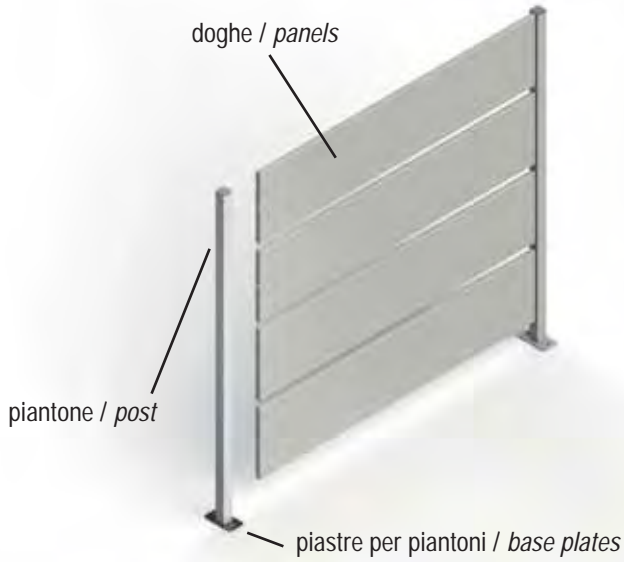

ART. **SCR 01**

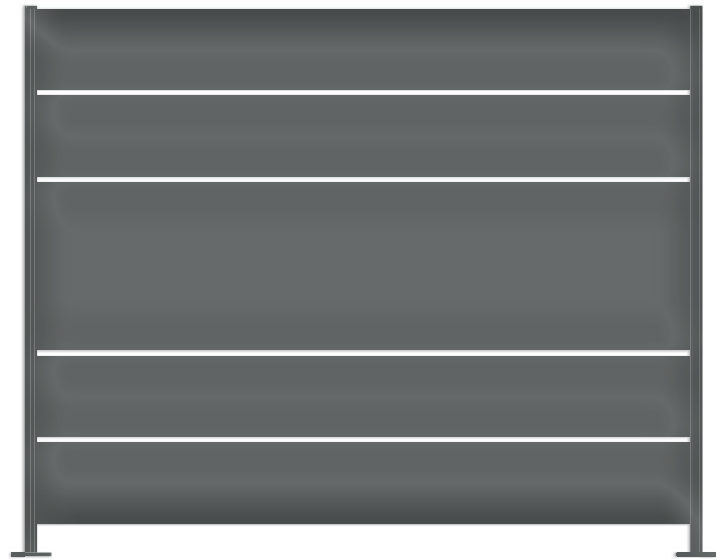

ART. **SCR 02**

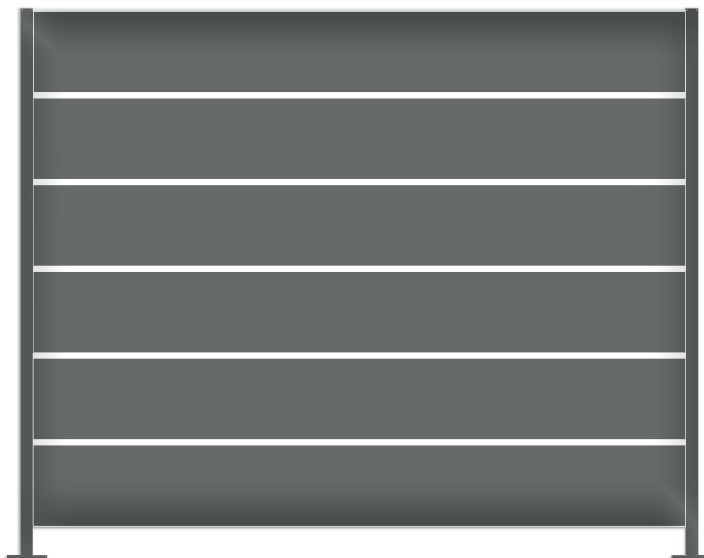

ART. **SCR 03**

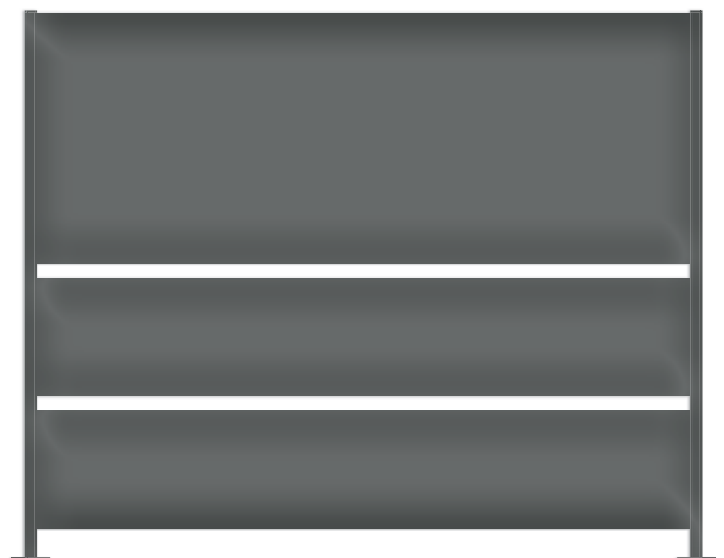

ART. **SCR 04**

La fattibilità della realizzazione del decoro va verificata in base a dimensioni e spessori della lastra. / The feasibility of making certain decorations may depend on plate size and thickness.  
 Tutte le parti di questo catalogo - foto comprese - sono di proprietà Euro-Fer. La riproduzione, anche parziale, è vietata in ogni forma e con ogni mezzo. / Every part of this catalogue - photos included - is Euro-Fer's property. All forms of copying are strictly prohibited.





ART. PAR 01



ART. PAR 02

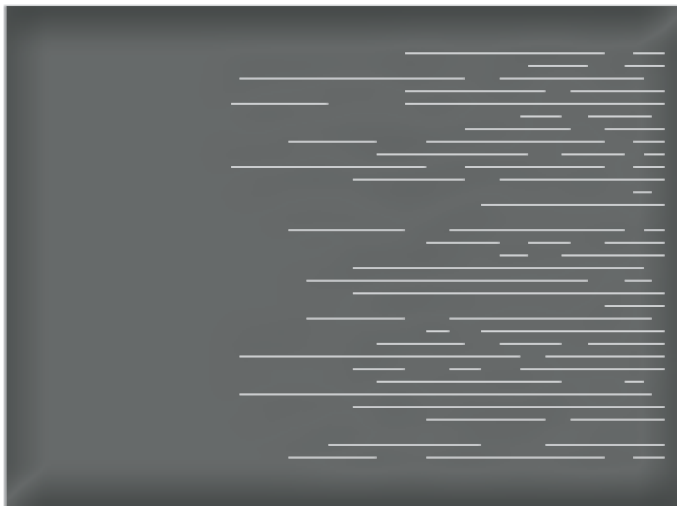

ART. PAR 03

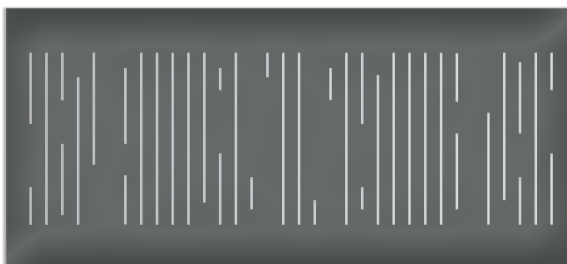

ART. PAR 06

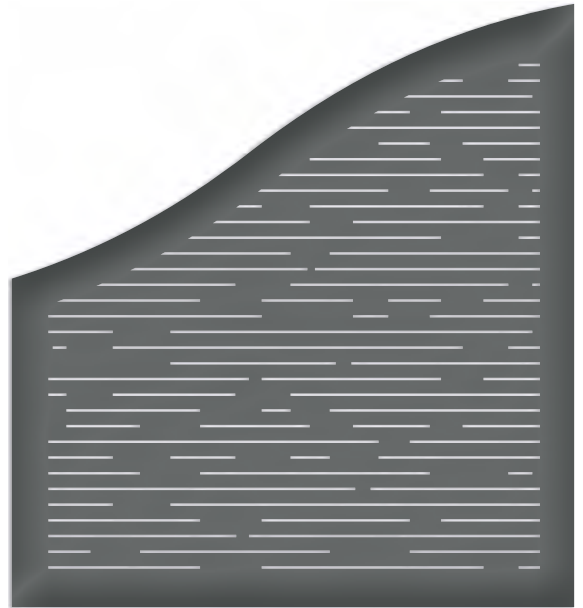

ART. PAR 04



ART. PAR 05



La fattibilità della realizzazione del decoro va verificata in base a dimensioni e spessori della lastra. / The feasibility of making certain decorations may depend on plate size and thickness.

Tutte le parti di questo catalogo - foto comprese - sono di proprietà Euro-Fer. La riproduzione, anche parziale, è vietata in ogni forma e con ogni mezzo. / Every part of this catalogue - photos included - is Euro-Fer's property. All forms of copying are strictly prohibited.



ART. PAR 07

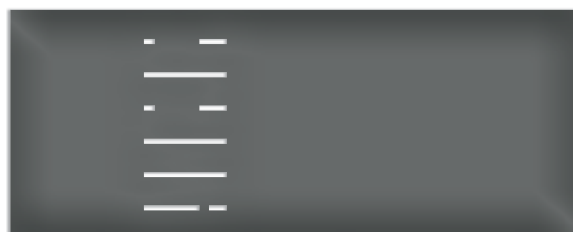

ART. PAR 09

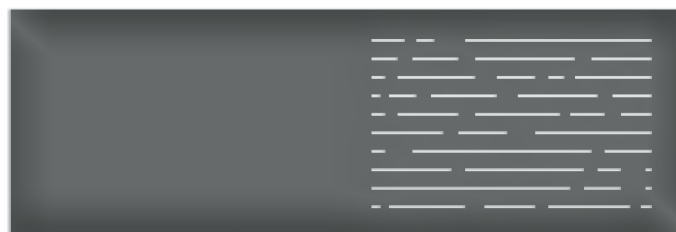

ART. PAR 12



ART. PAR 10

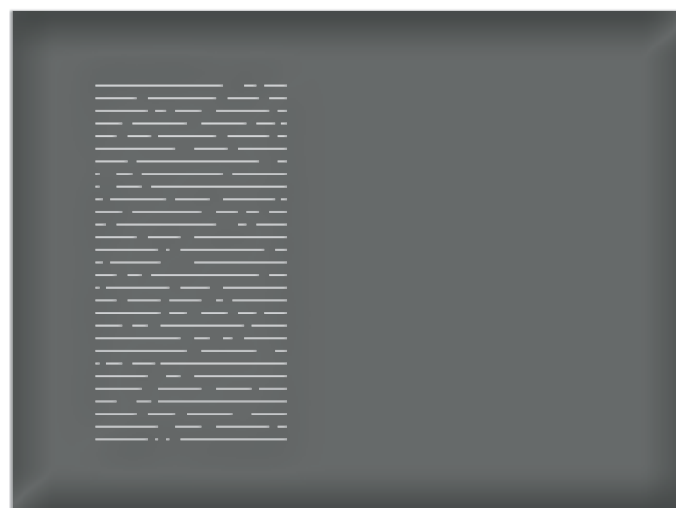

ART. PAR 13

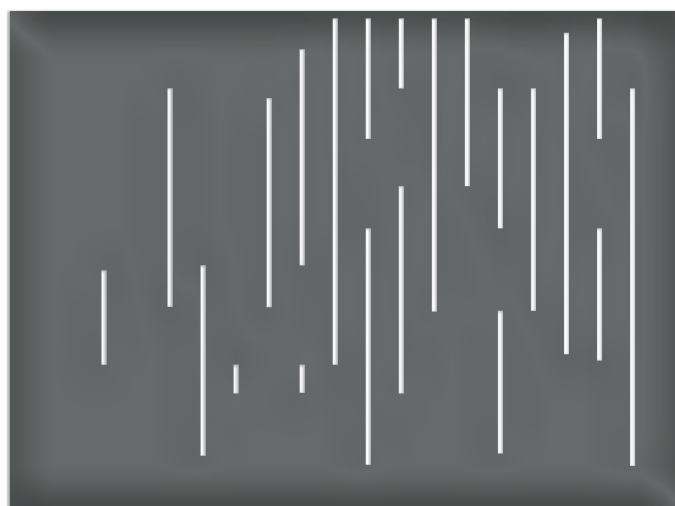

ART. PAR 11

La fattibilità della realizzazione del decoro va verificata in base a dimensioni e spessori della lastra. / The feasibility of making certain decorations may depend on plate size and thickness.

Tutte le parti di questo catalogo - foto comprese - sono di proprietà Euro-Fer. La riproduzione, anche parziale, è vietata in ogni forma e con ogni mezzo. / Every part of this catalogue - photos included - is Euro-Fer's property. All forms of copying are strictly prohibited.

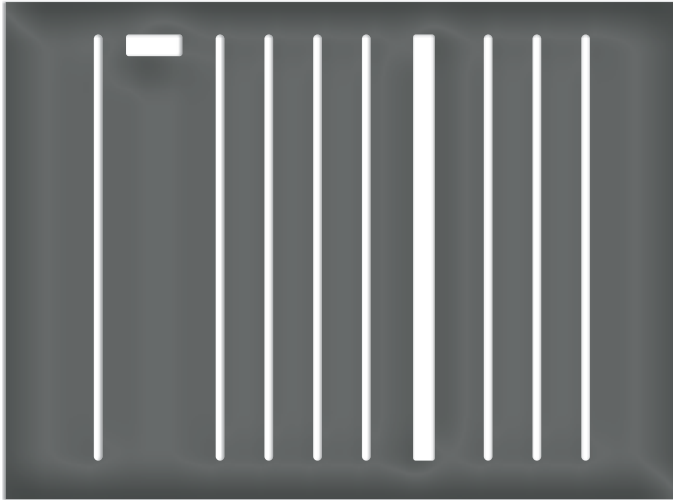

ART. PAR 14



ART. PAR 15

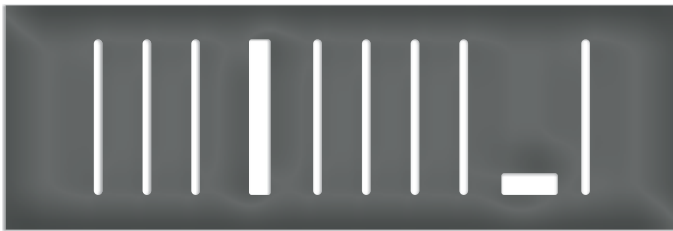

ART. PAR 16



ART. PAR 17

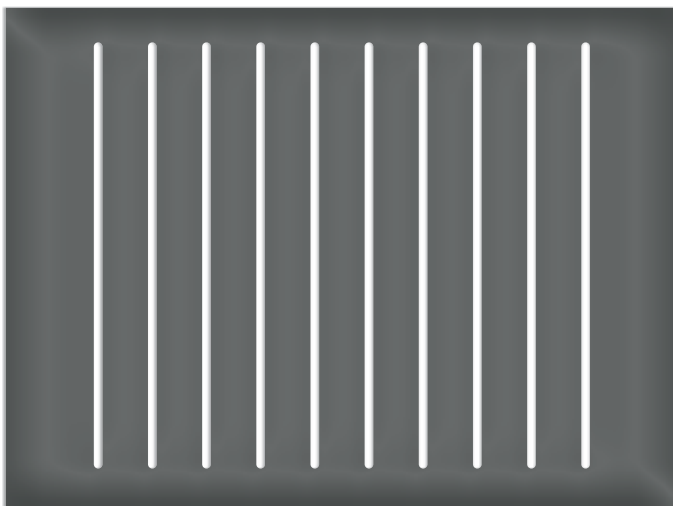

ART. PAR 18

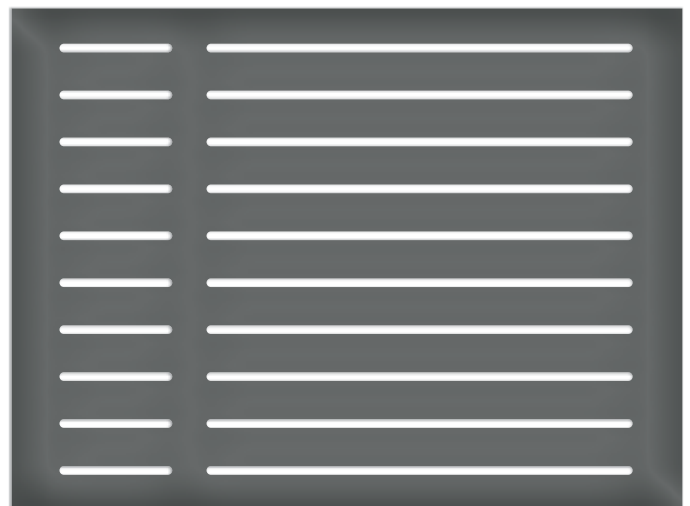

ART. PAR 19

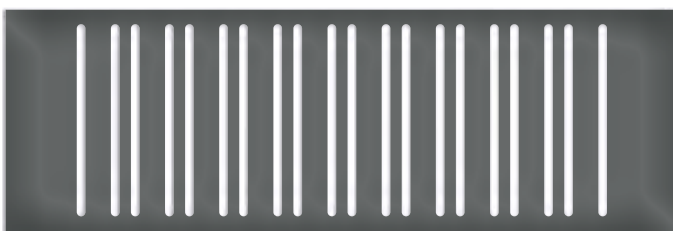

ART. PAR 20

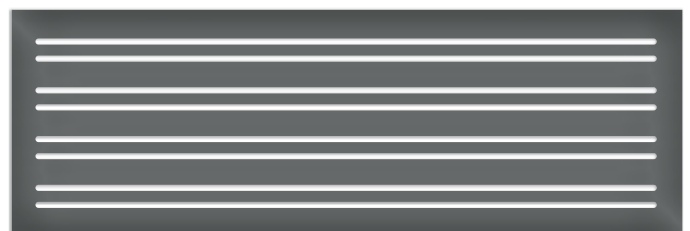

ART. PAR 21

La fattibilità della realizzazione del decoro va verificata in base a dimensioni e spessori della lastra. / The feasibility of making certain decorations may depend on plate size and thickness.

Tutte le parti di questo catalogo - foto comprese - sono di proprietà Euro-Fer. La riproduzione, anche parziale, è vietata in ogni forma e con ogni mezzo. / Every part of this catalogue - photos included - is Euro-Fer's property. All forms of copying are strictly prohibited.

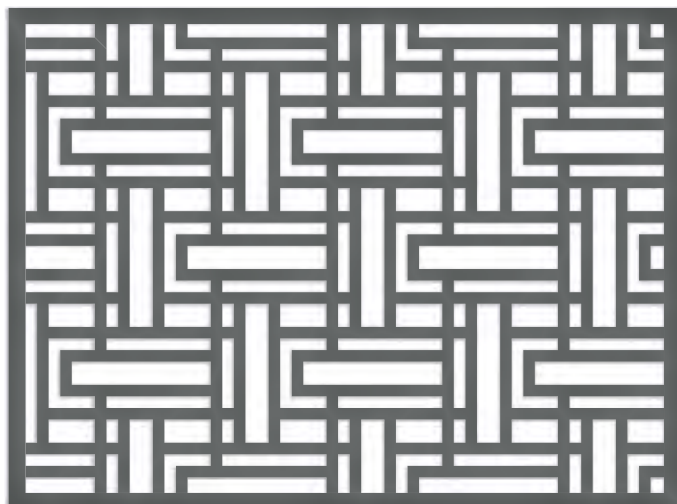

ART. GEO 01

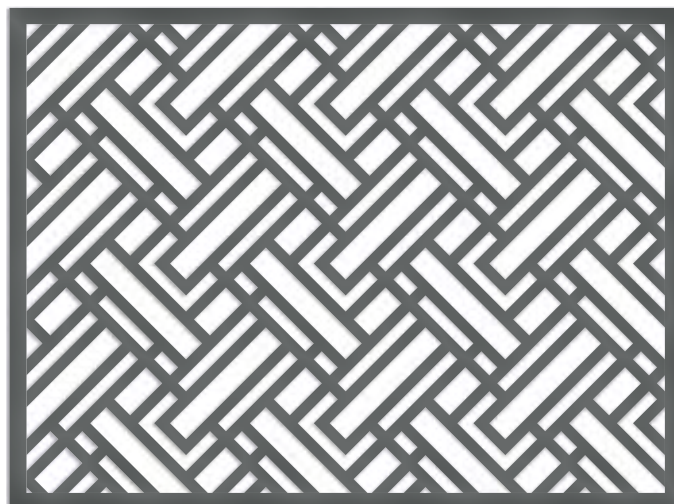

ART. GEO 02

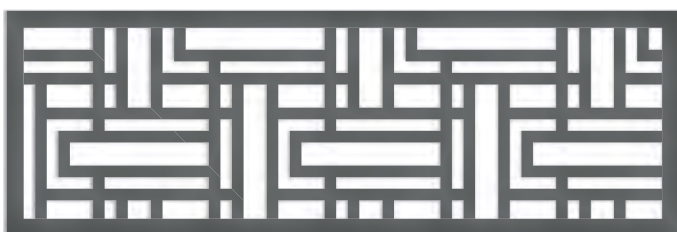

ART. GEO 03

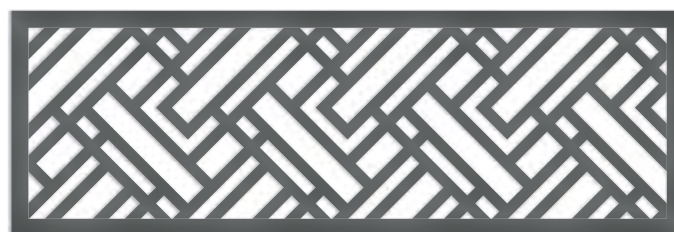

ART. GEO 04

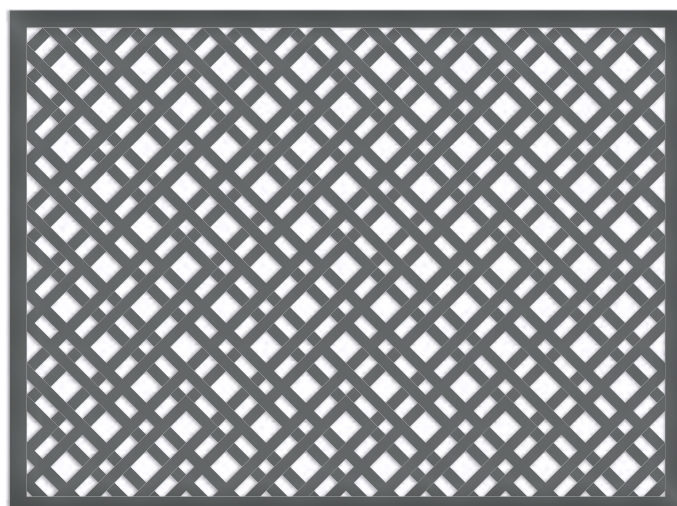

ART. GEO 05

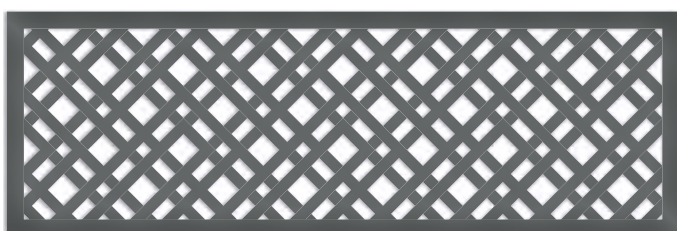

ART. GEO 06



La fattibilità della realizzazione del decoro va verificata in base a dimensioni e spessori della lastra. / The feasibility of making certain decorations may depend on plate size and thickness.  
Tutte le parti di questo catalogo - foto comprese - sono di proprietà Euro-Fer. La riproduzione, anche parziale, è vietata in ogni forma e con ogni mezzo. / Every part of this catalogue - photos included - is Euro-Fer's property. All forms of copying are strictly prohibited.

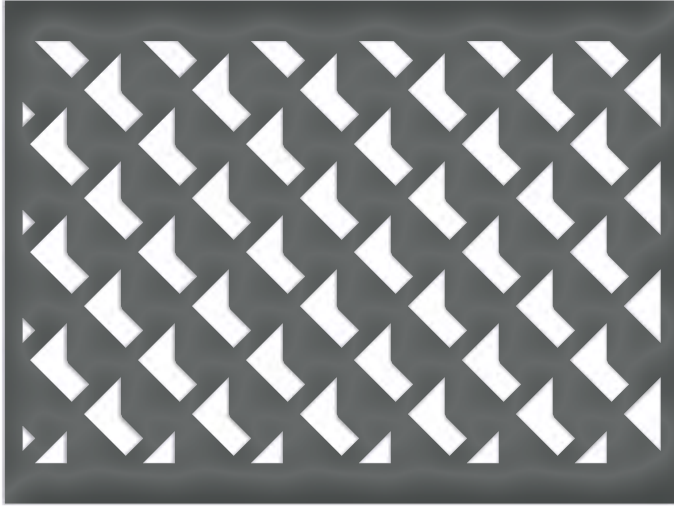

ART. QUA 05

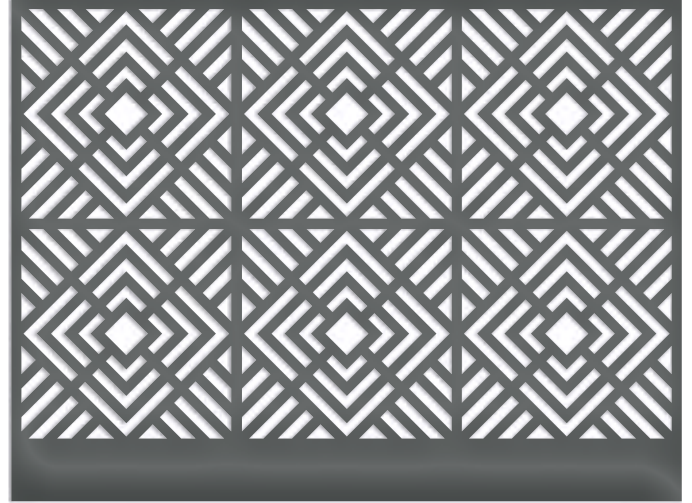

NEW

ART. QUA 07

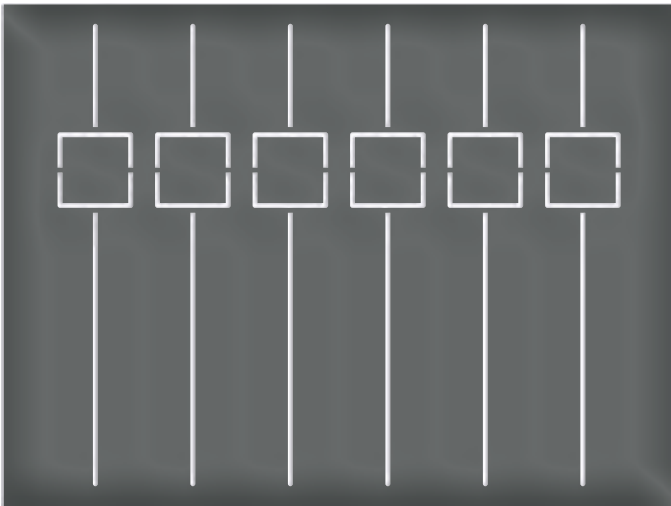

NEW

ART. QUA 08

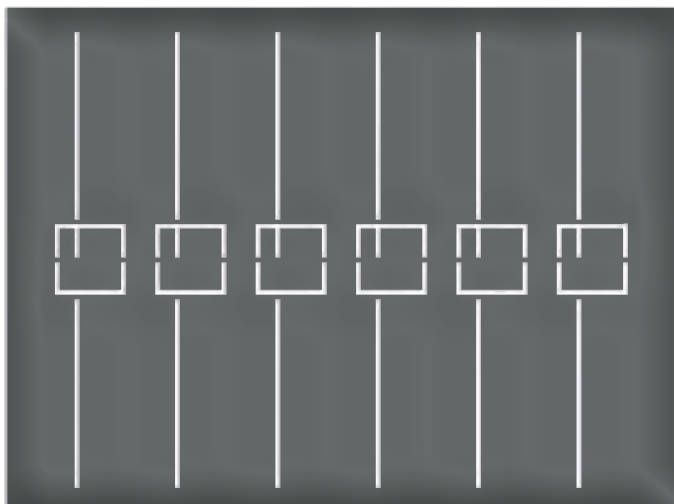

NEW

ART. QUA 09

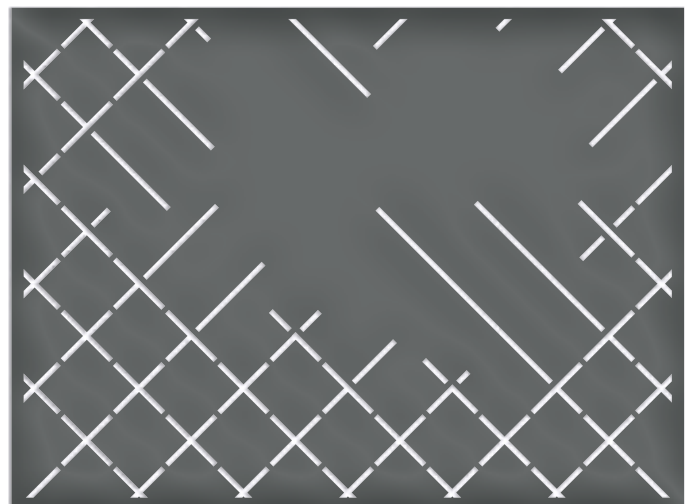

NEW

ART. QUA 10

La fattibilità della realizzazione del decoro va verificata in base a dimensioni e spessori della lastra. / The feasibility of making certain decorations may depend on plate size and thickness.

Tutte le parti di questo catalogo - foto comprese - sono di proprietà Euro-Fer. La riproduzione, anche parziale, è vietata in ogni forma e con ogni mezzo. / Every part of this catalogue - photos included - is Euro-Fer's property. All forms of copying are strictly prohibited.

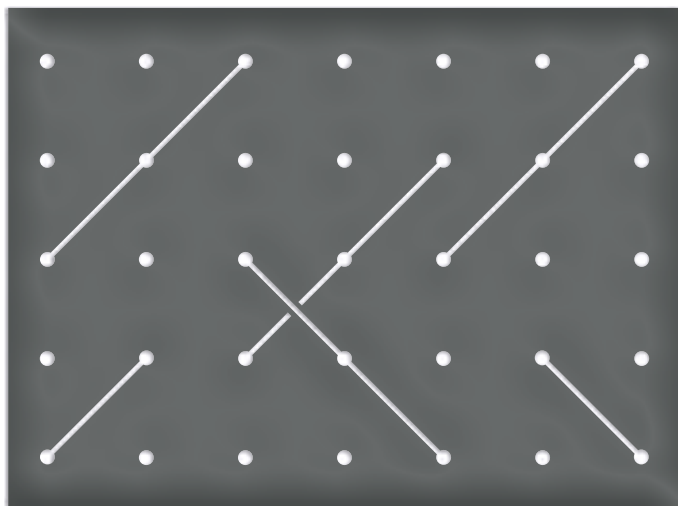

ART. SAR 01

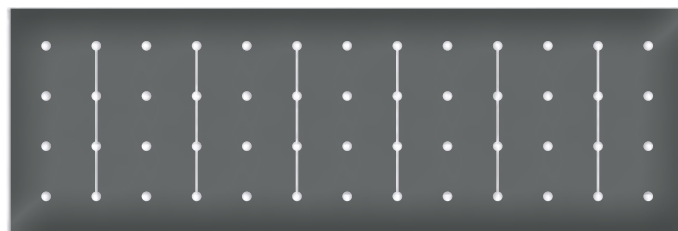

ART. SAR 06



LINEA SIDUS LINE



ART. SID 05

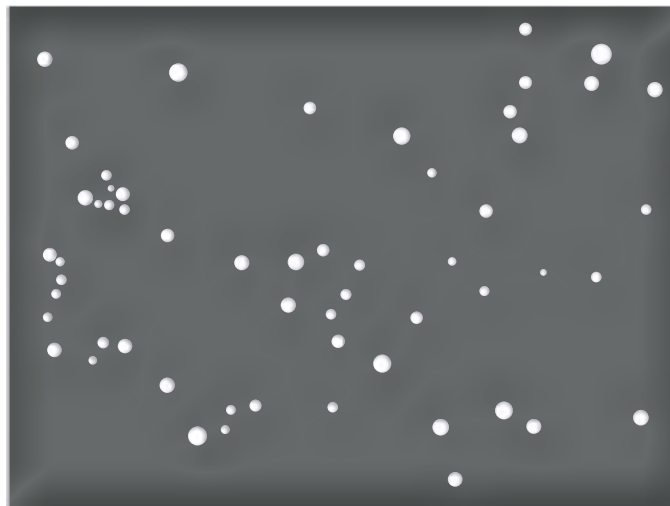

ART. SID 13

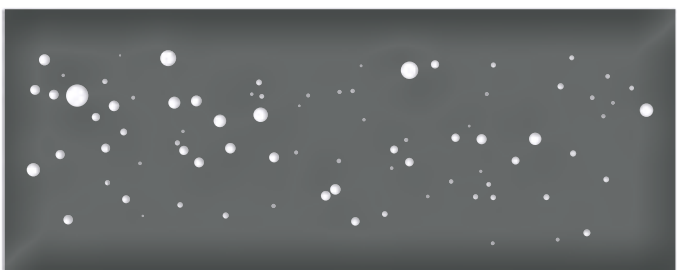

ART. SID 08

La fattibilità della realizzazione del decoro va verificata in base a dimensioni e spessori della lastra. / The feasibility of making certain decorations may depend on plate size and thickness.  
Tutte le parti di questo catalogo - foto comprese - sono di proprietà Euro-Fer. La riproduzione, anche parziale, è vietata in ogni forma e con ogni mezzo. / Every part of this catalogue - photos included - is Euro-Fer's property. All forms of copying are strictly prohibited.

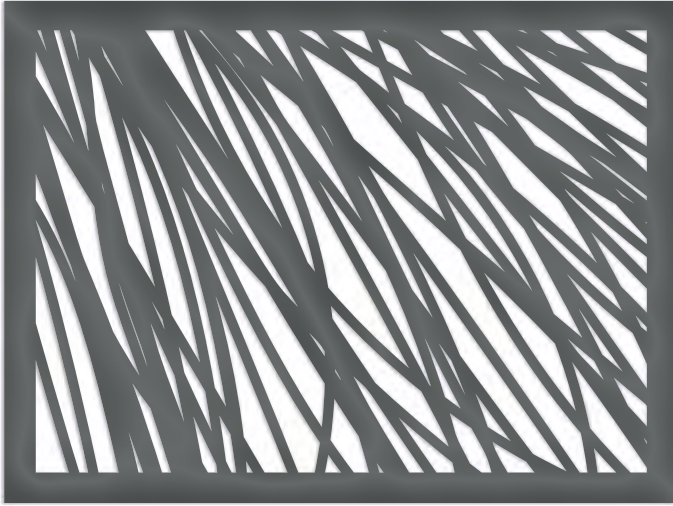

ART. RAM 01

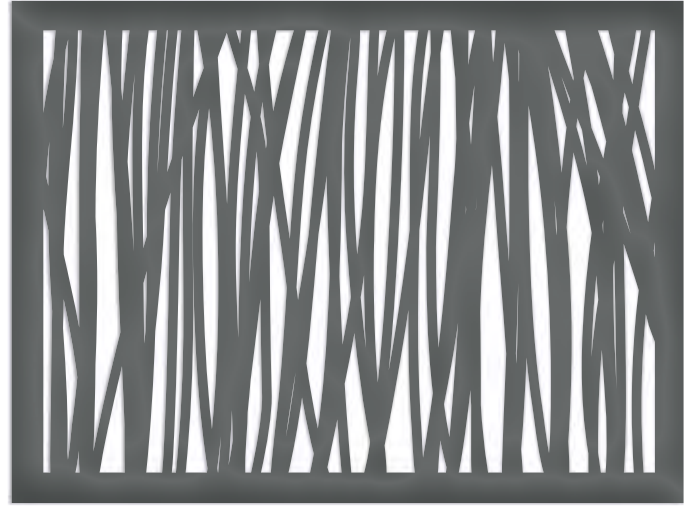

ART. RAM 02

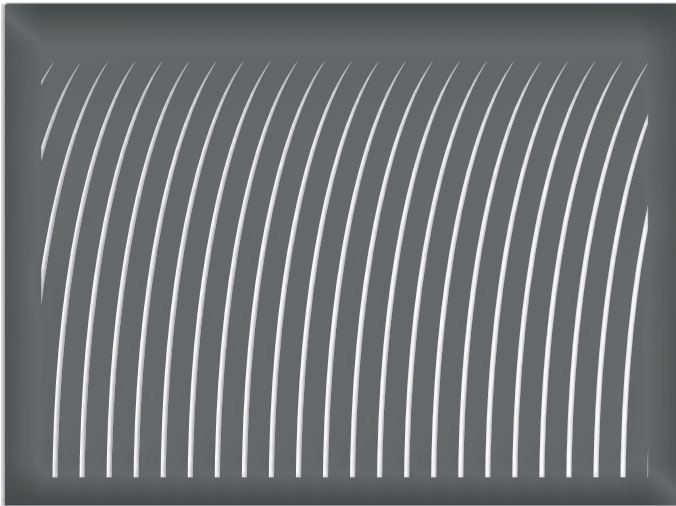

ART. RAM 03

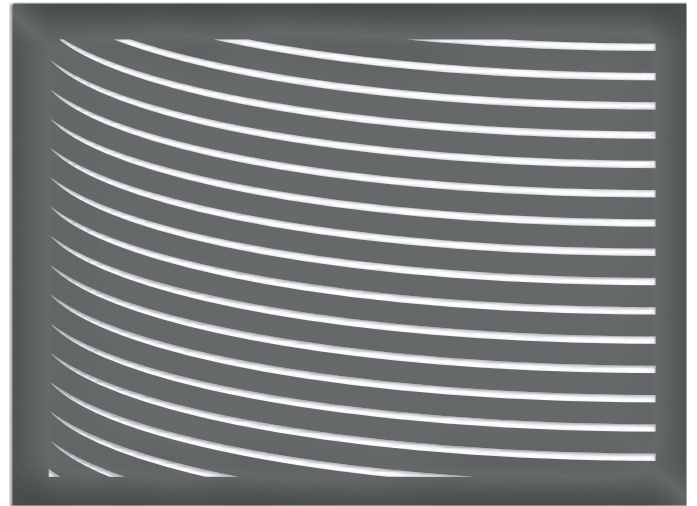

ART. RAM 04

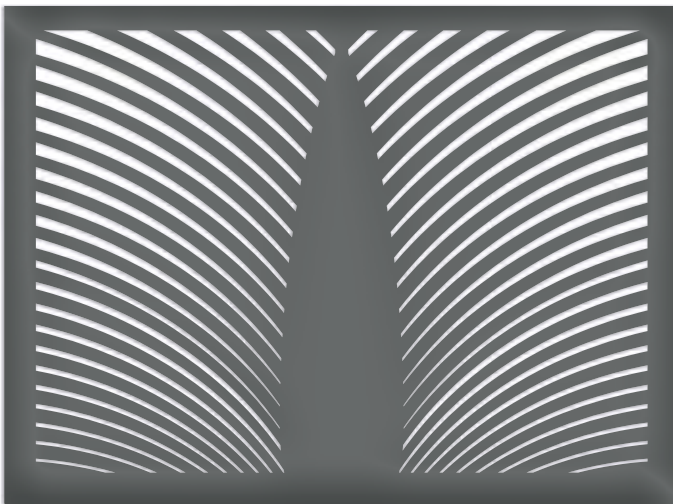

ART. RAM 05

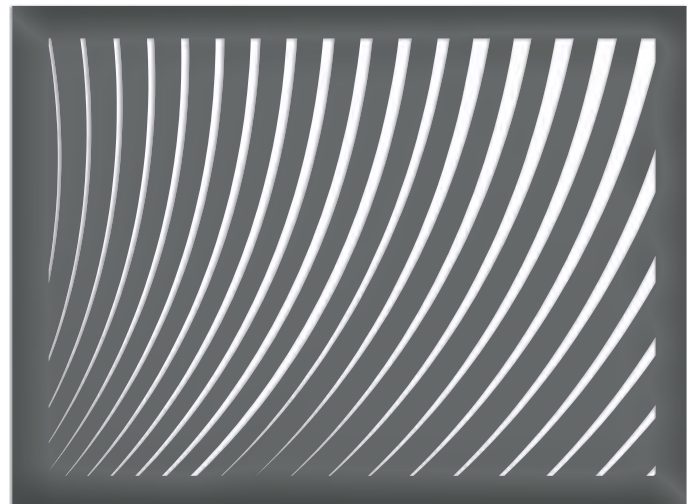

ART. RAM 06

La fattibilità della realizzazione del decoro va verificata in base a dimensioni e spessori della lastra. / The feasibility of making certain decorations may depend on plate size and thickness.

Tutte le parti di questo catalogo - foto comprese - sono di proprietà Euro-Fer. La riproduzione, anche parziale, è vietata in ogni forma e con ogni mezzo. / Every part of this catalogue - photos included - is Euro-Fer's property. All forms of copying are strictly prohibited.



La fattibilità della realizzazione del decoro va verificata in base a dimensioni e spessori della lastra. / The feasibility of making certain decorations may depend on plate size and thickness.  
Tutte le parti di questo catalogo - foto comprese - sono di proprietà Euro-Fer. La riproduzione, anche parziale, è vietata in ogni forma e con ogni mezzo. / Every part of this catalogue - photos included - is Euro-Fer's property. All forms of copying are strictly prohibited.



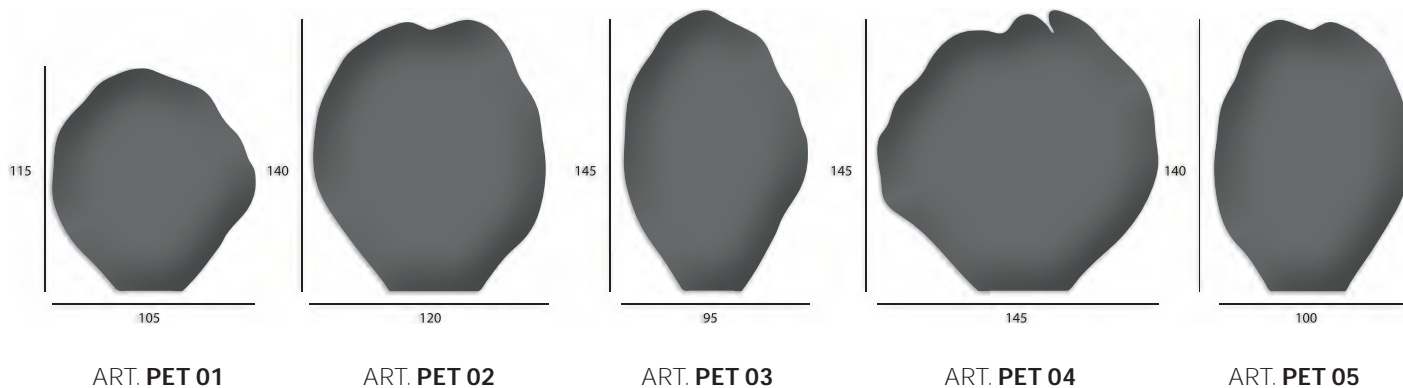

Petalis è un sistema modulare che può essere impiegato per dividere gli spazi, per creare zone indoor e outdoor, come parti di recinzioni, balaustre. I petali si possono utilizzare sovrapposti, accostati o intervallati da altri elementi del catalogo Eurofer.

*Petalis is a modular system that can be used to divide spaces, to create indoor and outdoor areas, such as parts of fences, balustrades. The petals can be used superimposed, juxtaposed or interspersed with other elements of the Eurofer catalog.*



La fattibilità della realizzazione del decoro va verificata in base a dimensioni e spessori della lastra. / The feasibility of making certain decorations may depend on plate size and thickness.

Tutte le parti di questo catalogo - foto comprese - sono di proprietà Euro-Fer. La riproduzione, anche parziale, è vietata in ogni forma e con ogni mezzo. / Every part of this catalogue - photos included - is Euro-Fer's property. All forms of copying are strictly prohibited.





ART. PRO 01



ART. PRO 04

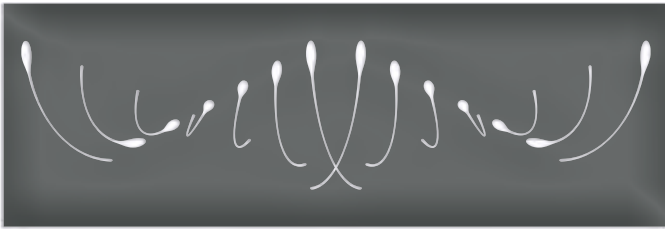

ART. PRO 02

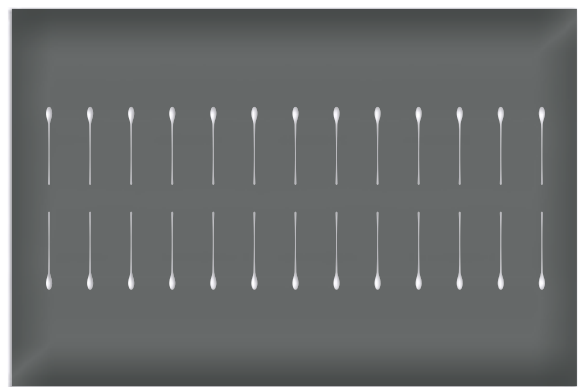

ART. PRO 05

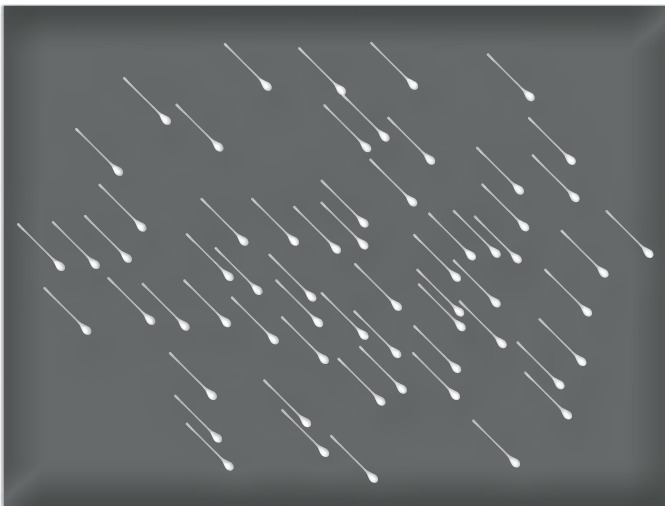

ART. PRO 03

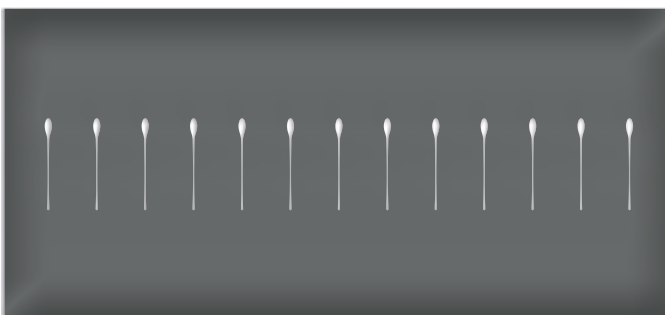

ART. PRO 06



La fattibilità della realizzazione del decoro va verificata in base a dimensioni e spessori della lastra. / The feasibility of making certain decorations may depend on plate size and thickness.

Tutte le parti di questo catalogo - foto comprese - sono di proprietà Euro-Fer. La riproduzione, anche parziale, è vietata in ogni forma e con ogni mezzo. / Every part of this catalogue - photos included - is Euro-Fer's property. All forms of copying are strictly prohibited.



ART. PRO 07

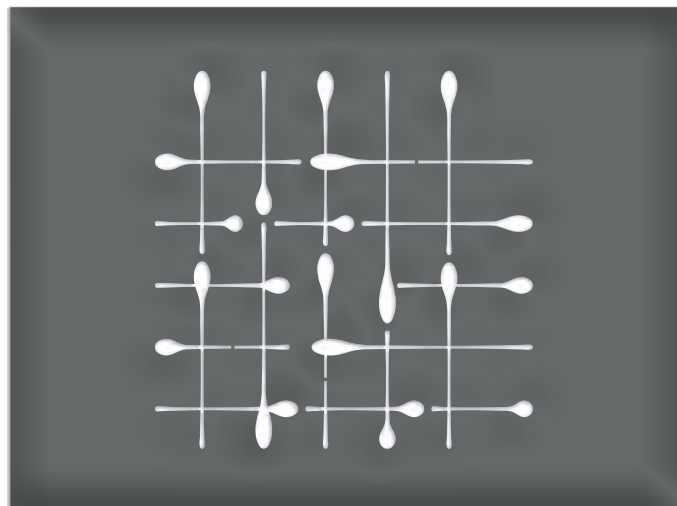

ART. PRO 11

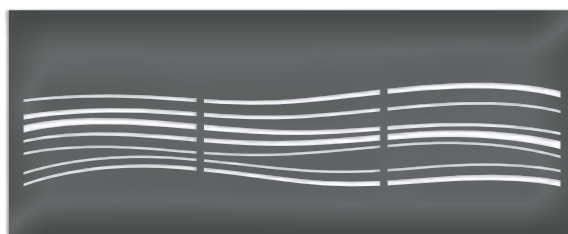

ART. PRO 08



ART. PRO 13



ART. PRO 10

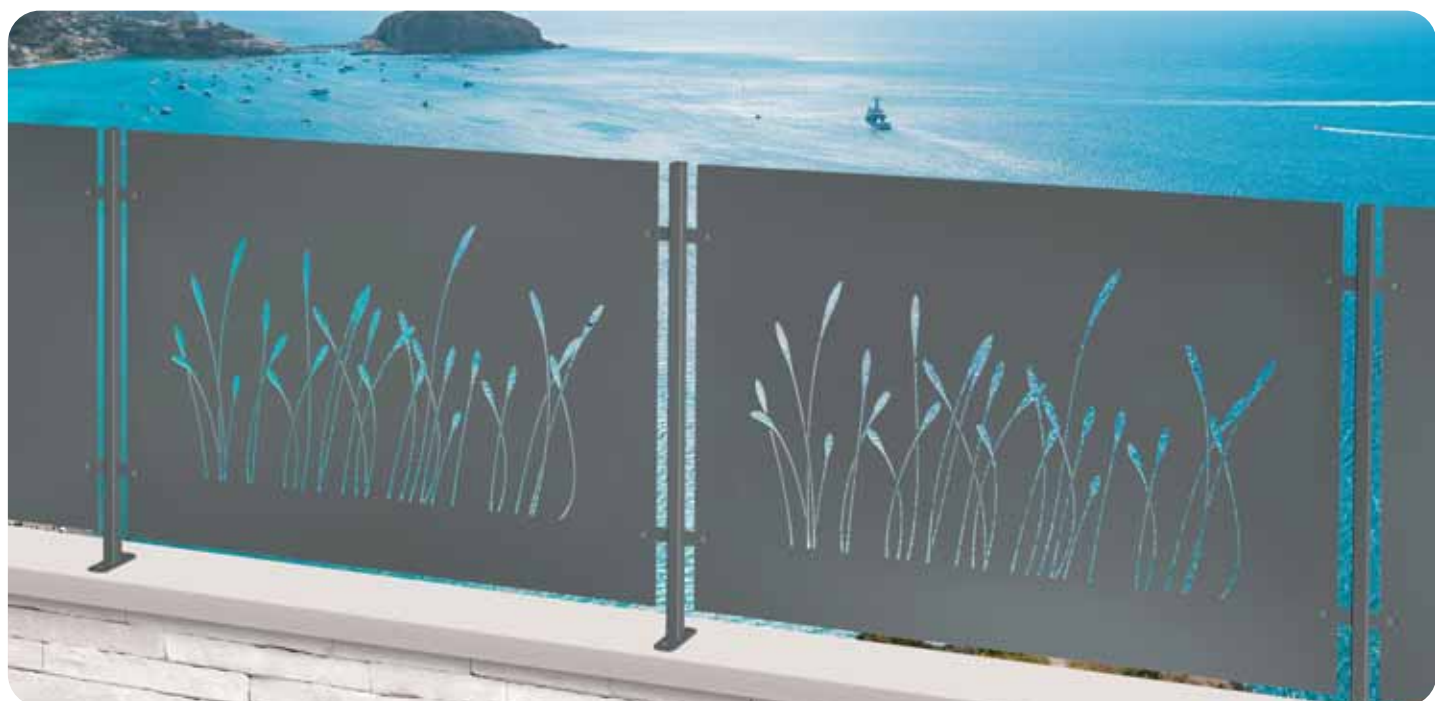

La fattibilità della realizzazione del decoro va verificata in base a dimensioni e spessori della lastra. / The feasibility of making certain decorations may depend on plate size and thickness.  
Tutte le parti di questo catalogo - foto comprese - sono di proprietà Euro-Fer. La riproduzione, anche parziale, è vietata in ogni forma e con ogni mezzo. / Every part of this catalogue - photos included - is Euro-Fer's property. All forms of copying are strictly prohibited.



ART. ROS 01



ART. ROS 02



ART. ROS 03



ART. ROS 04

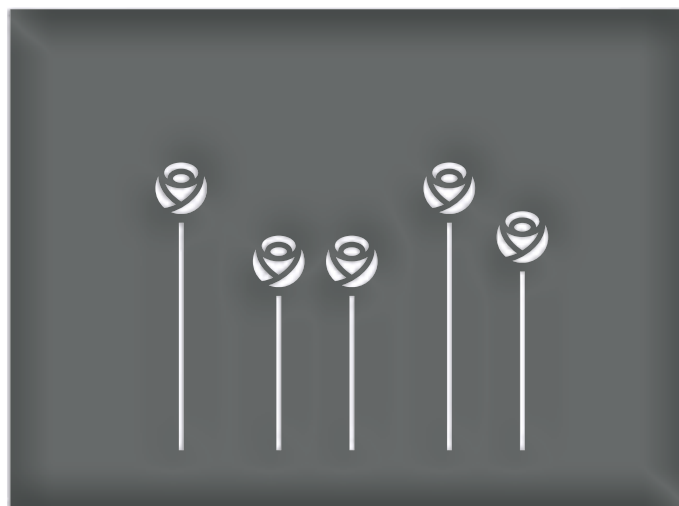

ART. ROS 05

La fattibilità della realizzazione del decoro va verificata in base a dimensioni e spessori della lastra. / The feasibility of making certain decorations may depend on plate size and thickness.

Tutte le parti di questo catalogo - foto comprese - sono di proprietà Euro-Fer. La riproduzione, anche parziale, è vietata in ogni forma e con ogni mezzo. / Every part of this catalogue - photos included - is Euro-Fer's property. All forms of copying are strictly prohibited.

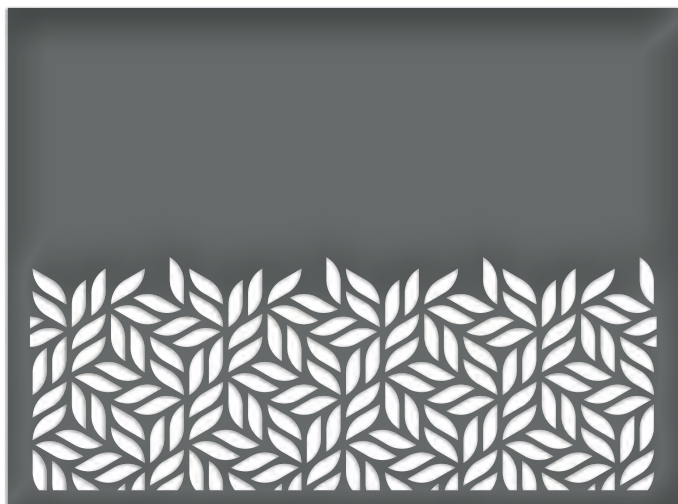

ART. PHY 01



ART. PHY 02



ART. PHY 03



ART. PHY 04

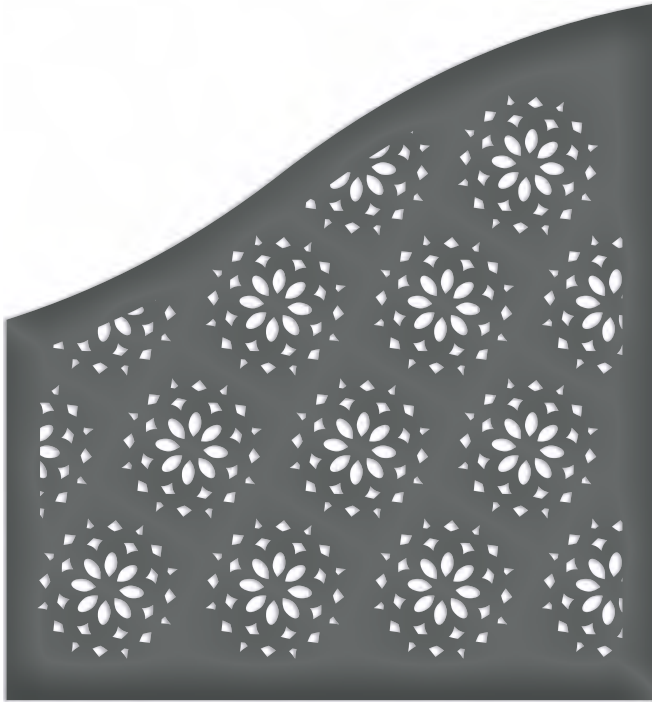
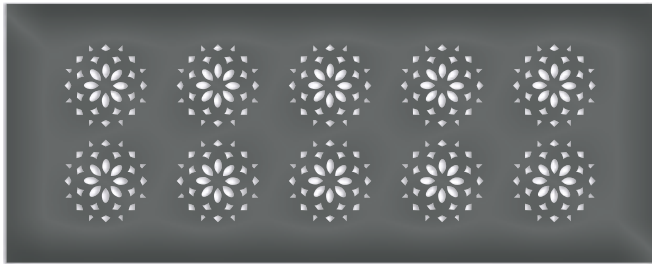
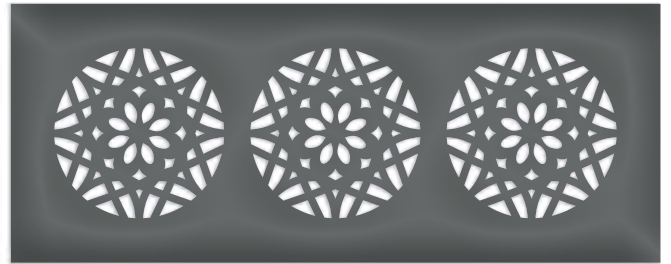

La fattibilità della realizzazione del decoro va verificata in base a dimensioni e spessori della lastra. / The feasibility of making certain decorations may depend on plate size and thickness.  
Tutte le parti di questo catalogo - foto comprese - sono di proprietà Euro-Fer. La riproduzione, anche parziale, è vietata in ogni forma e con ogni mezzo. / Every part of this catalogue - photos included - is Euro-Fer's property. All forms of copying are strictly prohibited.

ART. **AST 01**ART. **AST 02**ART. **AST 05**ART. **AST 06**

La fattibilità della realizzazione del decoro va verificata in base a dimensioni e spessori della lastra. / The feasibility of making certain decorations may depend on plate size and thickness.

Tutte le parti di questo catalogo - foto comprese - sono di proprietà Euro-Fer. La riproduzione, anche parziale, è vietata in ogni forma e con ogni mezzo. / Every part of this catalogue - photos included - is Euro-Fer's property. All forms of copying are strictly prohibited.

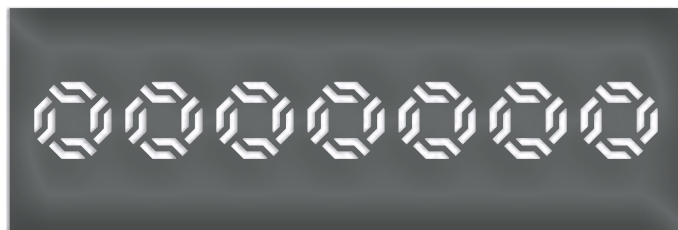

ART. OTT 02

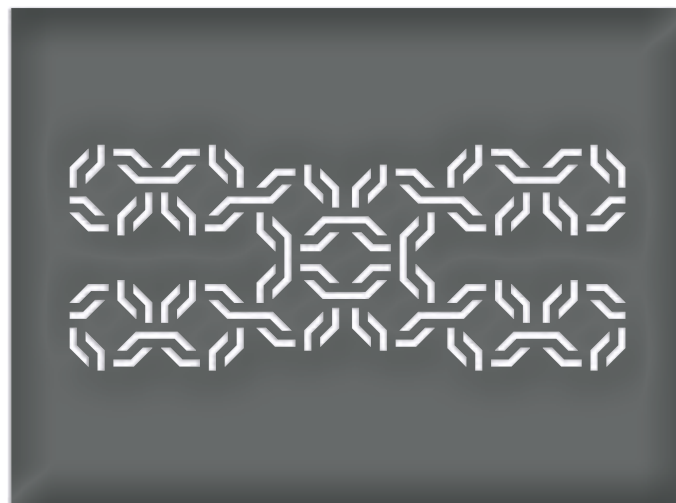

ART. OTT 03



ART. OTT 04



ART. OTT 07

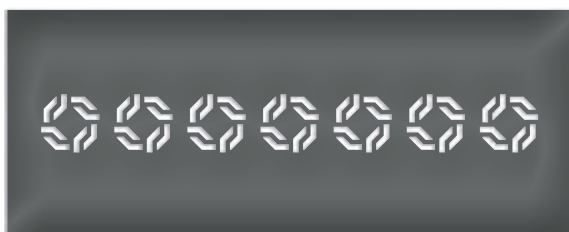

ART. OTT 08

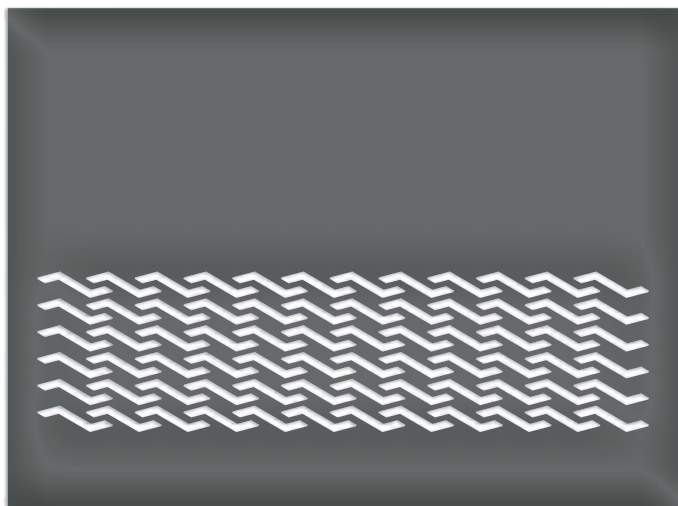

ART. OTT 11

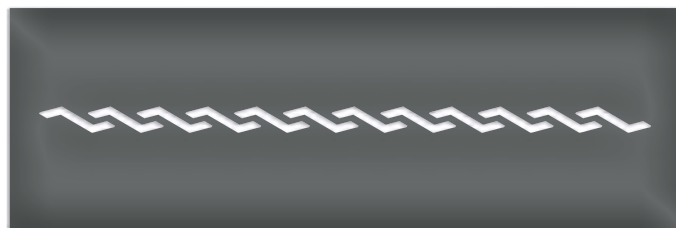

ART. OTT 12

La fattibilità della realizzazione del decoro va verificata in base a dimensioni e spessori della lastra. / The feasibility of making certain decorations may depend on plate size and thickness.  
Tutte le parti di questo catalogo - foto comprese - sono di proprietà Euro-Fer. La riproduzione, anche parziale, è vietata in ogni forma e con ogni mezzo. / Every part of this catalogue - photos included - is Euro-Fer's property. All forms of copying are strictly prohibited.





ART. CAN 01



ART. CAN 04

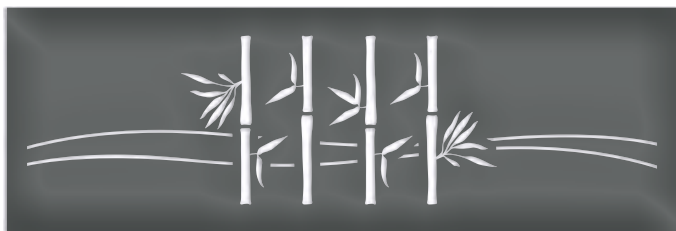

ART. CAN 02

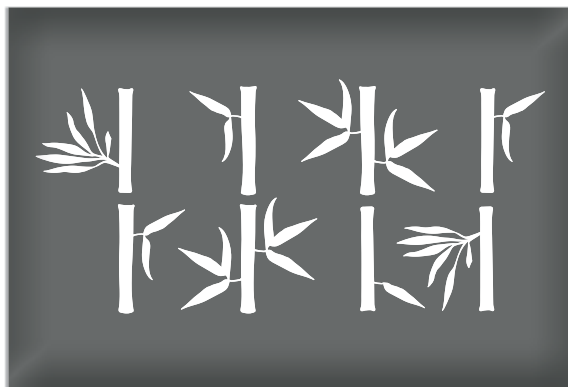

ART. CAN 05

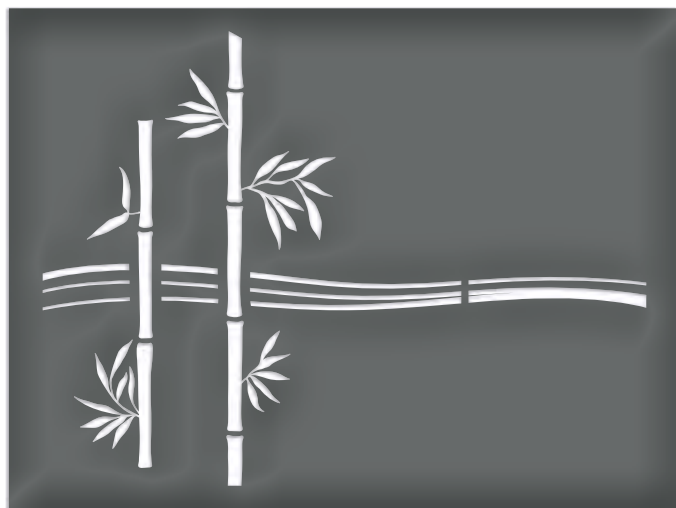

ART. CAN 03

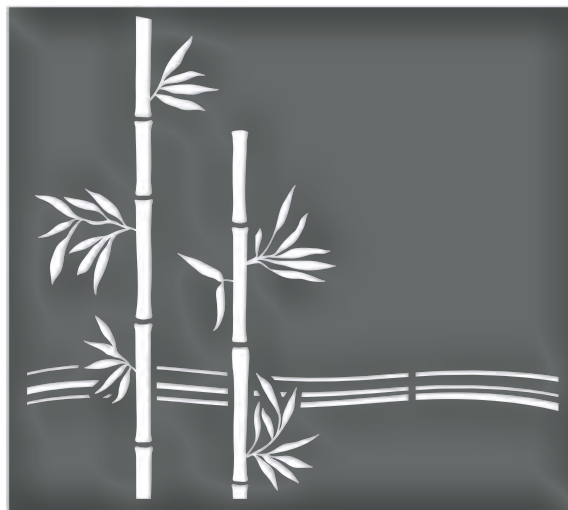

ART. CAN 07

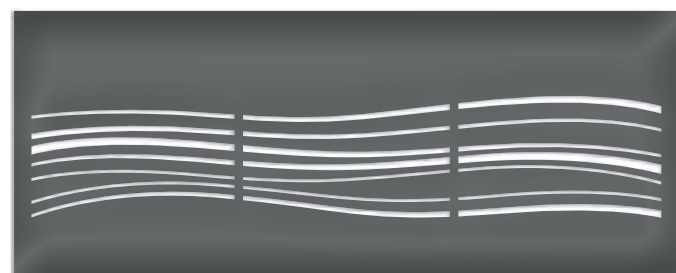

ART. CAN 08

La fattibilità della realizzazione del decoro va verificata in base a dimensioni e spessori della lastra. / The feasibility of making certain decorations may depend on plate size and thickness.

Tutte le parti di questo catalogo - foto comprese - sono di proprietà Euro-Fer. La riproduzione, anche parziale, è vietata in ogni forma e con ogni mezzo. / Every part of this catalogue - photos included - is Euro-Fer's property. All forms of copying are strictly prohibited.



ART. CAN 09

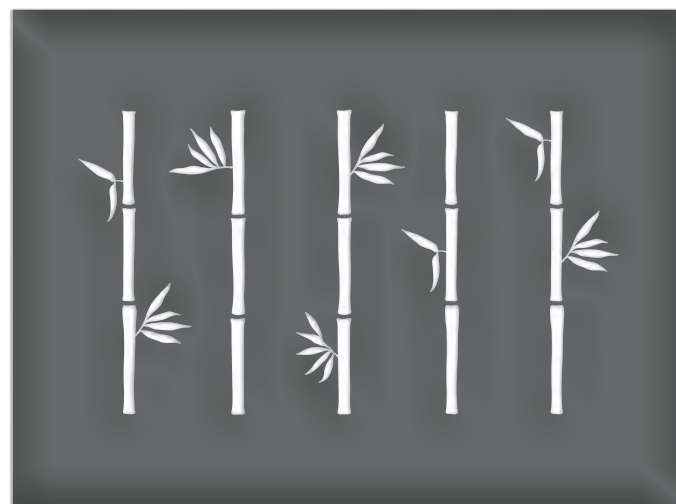

ART. CAN 11

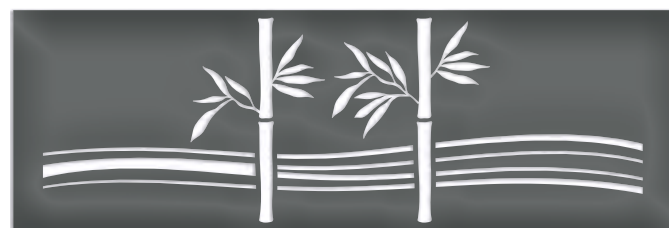

ART. CAN 12



La fattibilità della realizzazione del decoro va verificata in base a dimensioni e spessori della lastra. / The feasibility of making certain decorations may depend on plate size and thickness.  
Tutte le parti di questo catalogo - foto comprese - sono di proprietà Euro-Fer. La riproduzione, anche parziale, è vietata in ogni forma e con ogni mezzo. / Every part of this catalogue - photos included - is Euro-Fer's property. All forms of copying are strictly prohibited.

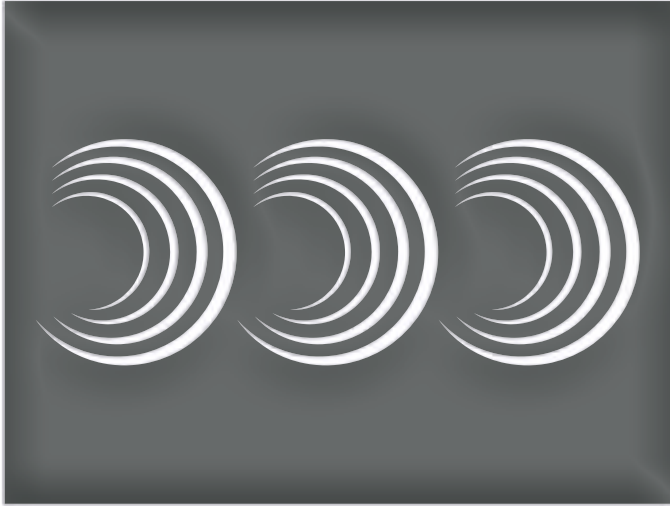

ART. SEC 01

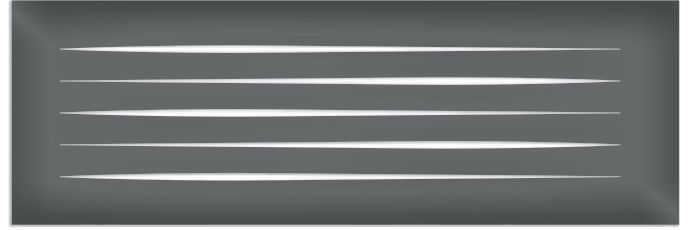

ART. SEC 02

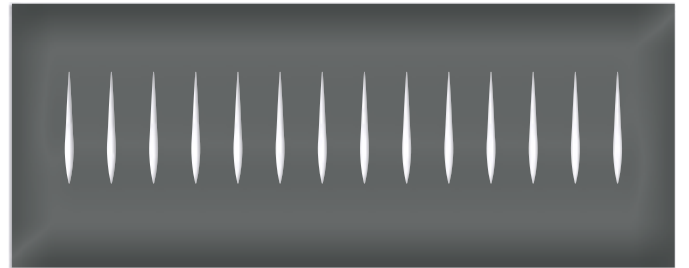

ART. SEC 08

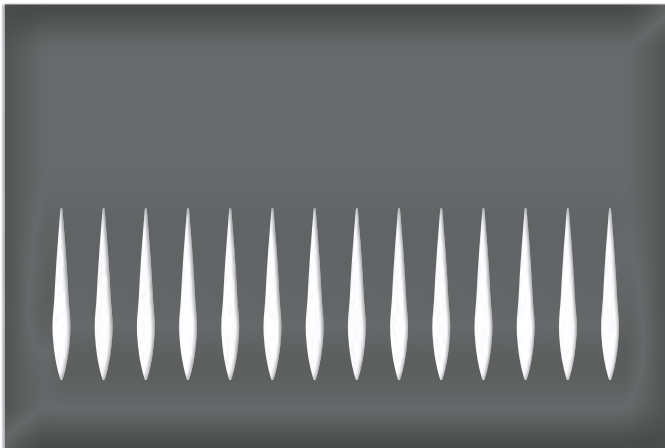

ART. SEC 05

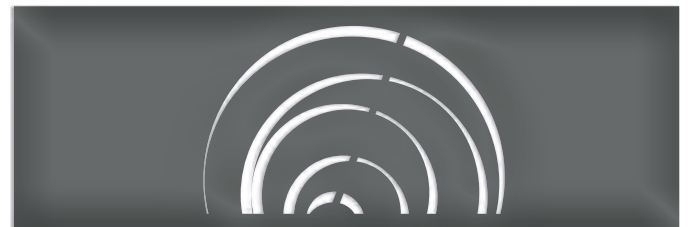

ART. SEC 12

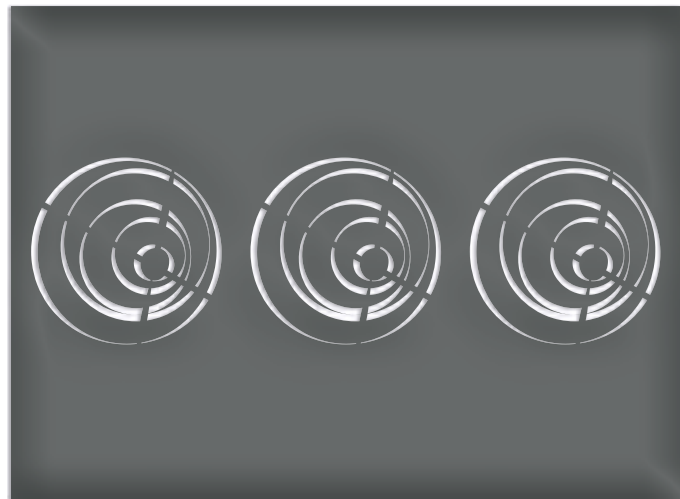

ART. SEC 11

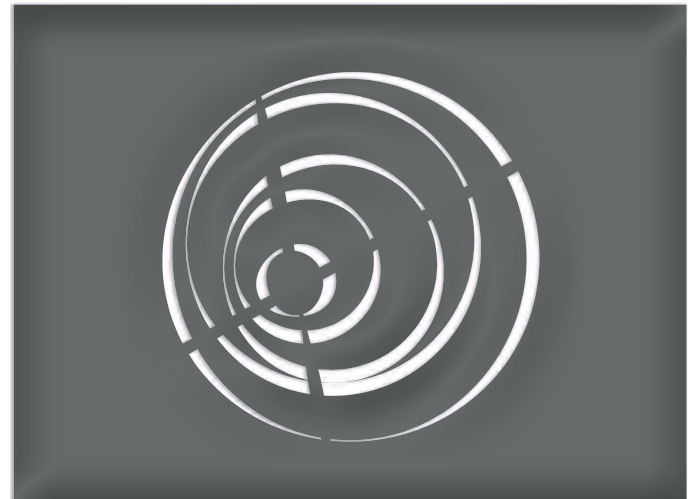

ART. SEC 13

La fattibilità della realizzazione del decoro va verificata in base a dimensioni e spessori della lastra. / The feasibility of making certain decorations may depend on plate size and thickness.

Tutte le parti di questo catalogo - foto comprese - sono di proprietà Euro-Fer. La riproduzione, anche parziale, è vietata in ogni forma e con ogni mezzo. / Every part of this catalogue - photos included - is Euro-Fer's property. All forms of copying are strictly prohibited.

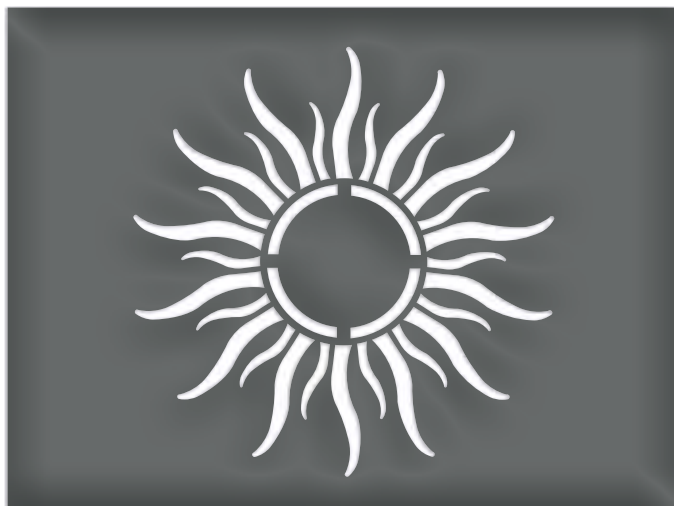

ART. SOL 01

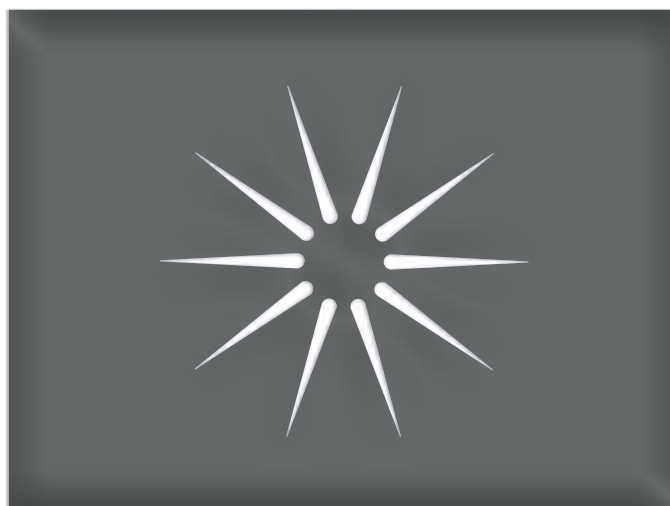

ART. SOL 02



ART. SOL 03



ART. SOL 04

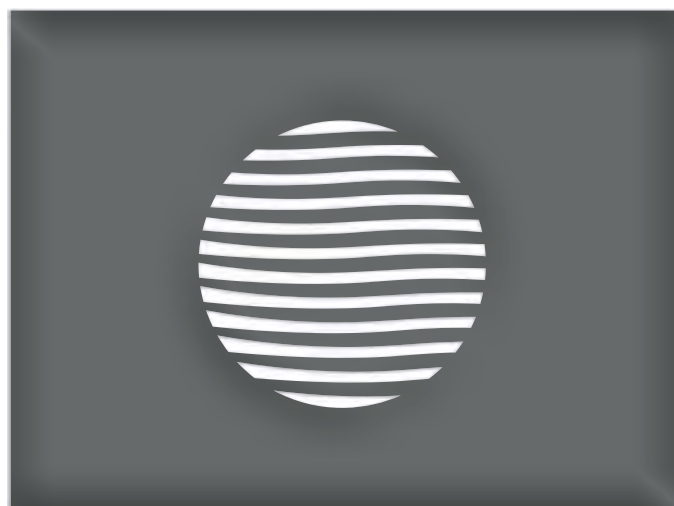

ART. SOL 05



ART. SOL 06

La fattibilità della realizzazione del decoro va verificata in base a dimensioni e spessori della lastra. / The feasibility of making certain decorations may depend on plate size and thickness.  
Tutte le parti di questo catalogo - foto comprese - sono di proprietà Euro-Fer. La riproduzione, anche parziale, è vietata in ogni forma e con ogni mezzo. / Every part of this catalogue - photos included - is Euro-Fer's property. All forms of copying are strictly prohibited.

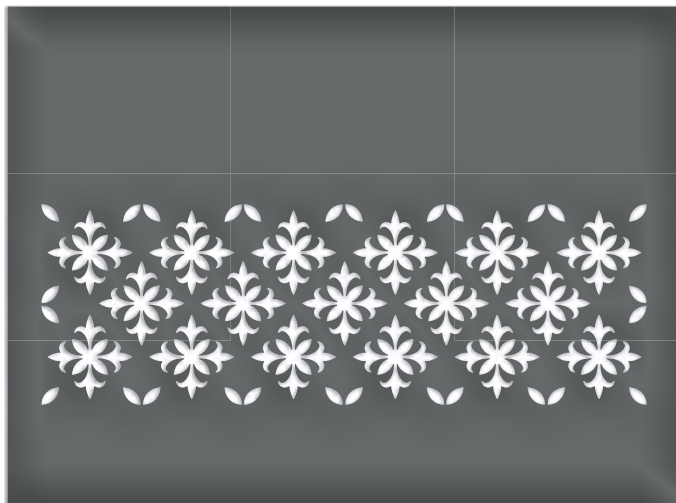

ART. ACA 01

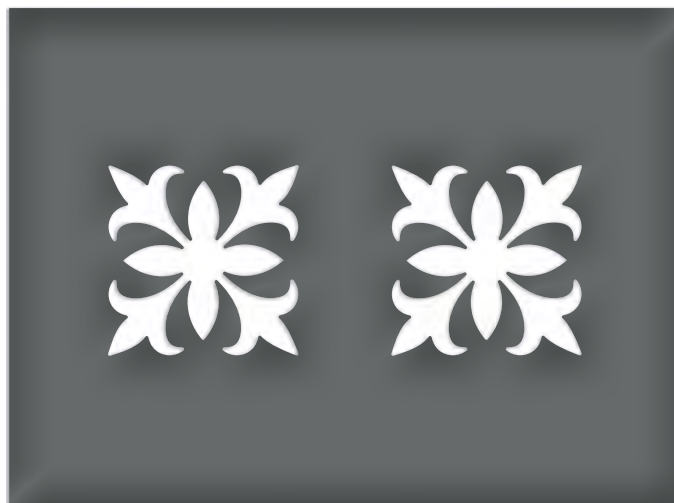

ART. ACA 02

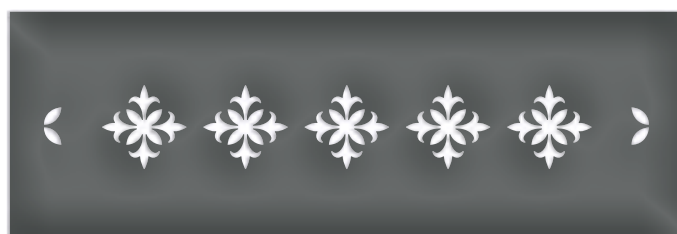

ART. ACA 03



ART. ACA 04



La fattibilità della realizzazione del decoro va verificata in base a dimensioni e spessori della lastra. / The feasibility of making certain decorations may depend on plate size and thickness.

Tutte le parti di questo catalogo - foto comprese - sono di proprietà Euro-Fer. La riproduzione, anche parziale, è vietata in ogni forma e con ogni mezzo. / Every part of this catalogue - photos included - is Euro-Fer's property. All forms of copying are strictly prohibited.

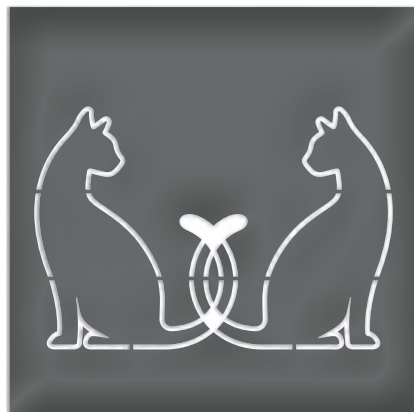

ART. CAT 01



ART. MIS 01



ART. MIS 02



ART. MIS 03

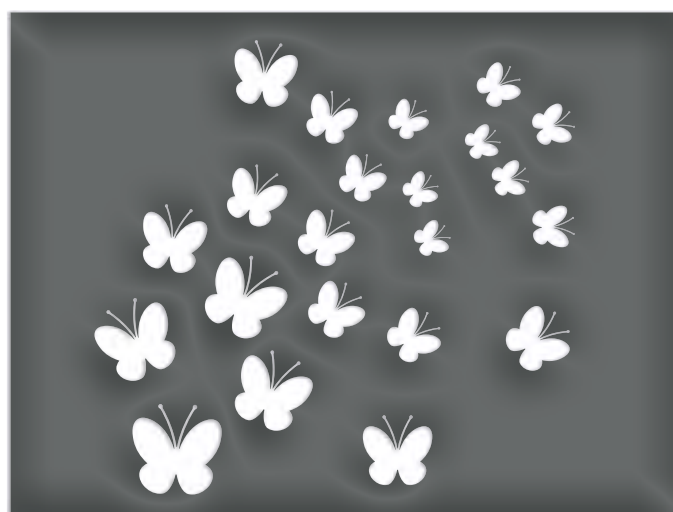

ART. MIS 05



ART. MIS 04

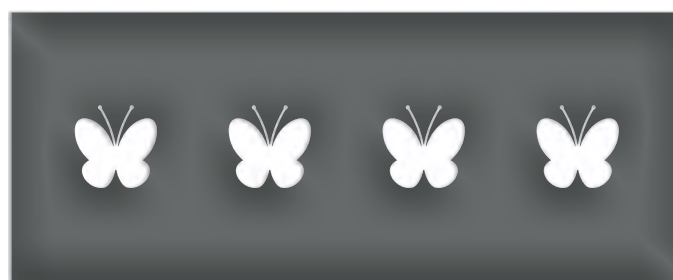

ART. MIS 06



ART. MIS 07

La fattibilità della realizzazione del decoro va verificata in base a dimensioni e spessori della lastra. / The feasibility of making certain decorations may depend on plate size and thickness.  
Tutte le parti di questo catalogo - foto comprese - sono di proprietà Euro-Fer. La riproduzione, anche parziale, è vietata in ogni forma e con ogni mezzo. / Every part of this catalogue - photos included - is Euro-Fer's property. All forms of copying are strictly prohibited.

SPESSORE / THICKNESS mm 6 - 8

- 15 -



410x330 mm

LR001.60/10.FE  
LR001.80/10.FE

- 12,5 -



410x330 mm

LR004.60/10.FE  
LR004.80/10.FE

- 12,5 -



410x330 mm

LR005.60/10.FE  
LR005.80/10.FE

- 12,5 -



410x330 mm

LR006.60/10.FE  
LR006.80/10.FE

- 15 -



430x350 mm

LR007.60/10.FE  
LR007.80/10.FE

- 15 -



430x350 mm

LR008.60/10.FE  
LR008.80/10.FE

- 15 -



430x350 mm

LR009.60/10.FE  
LR009.80/10.FE

- 15 -



430x350 mm

LR010.60/10.FE  
LR010.80/10.FE

- 15 -



430x350 mm

LR011.60/10.FE  
LR011.80/10.FE

- 15 -



430x350 mm

LR0110.60/10.FE  
LR0110.80/10.FE

- 15 -



430x350 mm

LR0111.60/10.FE  
LR0111.80/10.FE

La fattibilità della realizzazione del decoro va verificata in base a dimensioni e spessori della lastra. / The feasibility of making certain decorations may depend on plate size and thickness.

Tutte le parti di questo catalogo - foto comprese - sono di proprietà Euro-Fer. La riproduzione, anche parziale, è vietata in ogni forma e con ogni mezzo. / Every part of this catalogue - photos included - is Euro-Fer's property. All forms of copying are strictly prohibited.

- 12,5 -



290x160 mm

LR012.60/10.FE  
LR012.80/10.FE

- 12,5 -



290x160 mm

LR013.60/10.FE  
LR013.80/10.FE

- 12,5 -



290x160 mm

LR014.60/10.FE  
LR014.80/10.FE

- 15 -



290x160 mm

LR015.60/10.FE  
LR015.80/10.FE

- 15 -



290x160 mm

LR016.60/10.FE  
LR016.80/10.FE



La fattibilità della realizzazione del decoro va verificata in base a dimensioni e spessori della lastra. / The feasibility of making certain decorations may depend on plate size and thickness.  
Tutte le parti di questo catalogo - foto comprese - sono di proprietà Euro-Fer. La riproduzione, anche parziale, è vietata in ogni forma e con ogni mezzo. / Every part of this catalogue - photos included - is Euro-Fer's property. All forms of copying are strictly prohibited.



- 12,5 -



430x150 mm

LR023.60/10.FE  
LR023.80/10.FE

- 12,5 -



430x150 mm

LR024.60/10.FE  
LR024.80/10.FE

- 15 -



430x150 mm

LR026.60/10.FE  
LR026.80/10.FE

- 15 -



430x150 mm

LR027.60/10.FE  
LR027.80/10.FE

- 15 -



430x150 mm

LR028.60/10.FE  
LR028.80/10.FE

- 15 -



430x150 mm

LR029.60/10.FE  
LR029.80/10.FE

- 15 -



376x160 mm

LR030.60/10.FE  
LR030.80/10.FE

- 15 -



288x160 mm

LR031.60/10.FE  
LR031.80/10.FE

- 15 -



435x160 mm

LR032.60/10.FE  
LR032.80/10.FE

- 15 -



435x160 mm

LR033.60/10.FE  
LR033.80/10.FE

## TERMINALI ferro grezzo / POST TOPS raw iron

SPESSORE / THICKNESS mm 6 - 8



250

70

LT001.60/10.FE  
LT001.80/10.FE

250

70

LT002.60/10.FE  
LT002.80/10.FE

250

60

LT003.60/10.FE  
LT003.80/10.FE

230

60

LT004.60/10.FE  
LT004.80/10.FE

250

80

LT005.60/10.FE  
LT005.80/10.FE

200

40

LT006.60/10.FE  
LT006.80/10.FE

200

50

LT007.60/10.FE  
LT007.80/10.FE

La fattibilità della realizzazione del decoro va verificata in base a dimensioni e spessori della lastra. / The feasibility of making certain decorations may depend on plate size and thickness.  
Tutte le parti di questo catalogo - foto comprese - sono di proprietà Euro-Fer. La riproduzione, anche parziale, è vietata in ogni forma e con ogni mezzo. / Every part of this catalogue - photos included - is Euro-Fer's property. All forms of copying are strictly prohibited.

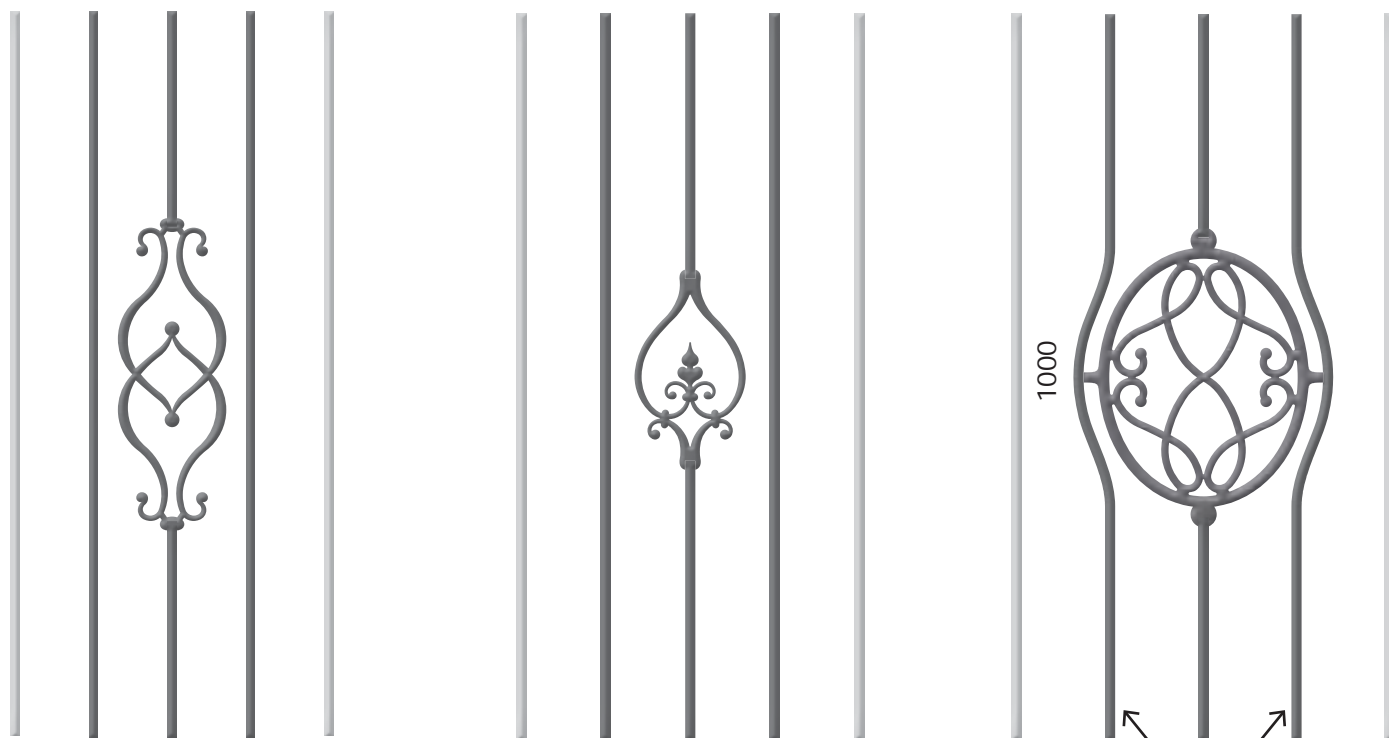

LQ12.SAG.H1000

LQ14.SAG.H1000



La fattibilità della realizzazione del decoro va verificata in base a dimensioni e spessori della lastra. / The feasibility of making certain decorations may depend on plate size and thickness.  
Tutte le parti di questo catalogo - foto comprese - sono di proprietà Euro-Fer. La riproduzione, anche parziale, è vietata in ogni forma e con ogni mezzo. / Every part of this catalogue - photos included - is Euro-Fer's property. All forms of copying are strictly prohibited.

Richiedere scheda informativa all'ufficio tecnico.  
Please contact the technical office for more information.



NEW



98

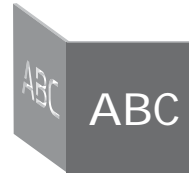

### PIASTRE PER PIANTONI ferro grezzo / BASE PLATES raw iron

SPESSORE / THICKNESS mm 4 - 6

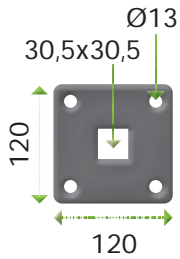

LP001.40/10.FE  
LP001.60/10.FE

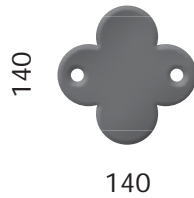

LP002.40/10.FE  
LP002.60/10.FE

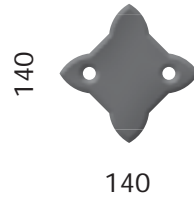

LP003.40/10.FE  
LP003.60/10.FE

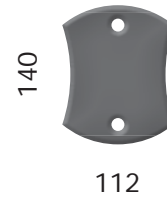

LP004.40/10.FE  
LP004.60/10.FE



LP005.40/10.FE  
LP005.60/10.FE

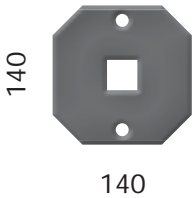

LP006.40/10.FE  
LP006.60/10.FE

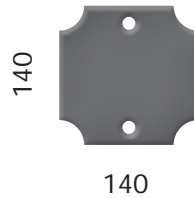

LP007.40/10.FE  
LP007.60/10.FE

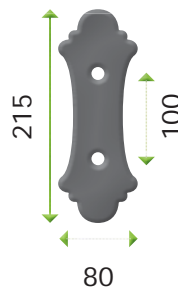

LP008.40/10.FE  
LP008.60/10.FE

NEW

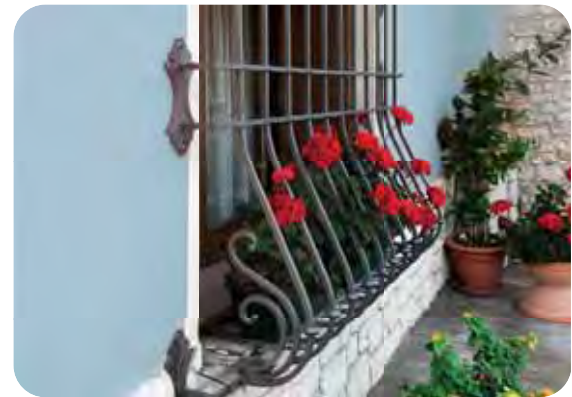

### STAFFE DI FISSAGGIO ferro grezzo / LUGS & FIXINGS raw iron

SPESSORE / THICKNESS mm 4 - 6



LS001.40/10.FE  
LS001.60/10.FE

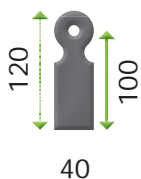

LS002.40/10.FE  
LS002.60/10.FE



LS003.40/10.FE  
LS003.60/10.FE



LS004.40/10.FE  
LS004.60/10.FE



LS005.40/10.FE  
LS005.60/10.FE

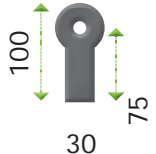

LS006.40/10.FE  
LS006.60/10.FE

La fattibilità della realizzazione del decoro va verificata in base a dimensioni e spessori della lastra. / The feasibility of making certain decorations may depend on plate size and thickness.

Tutte le parti di questo catalogo - foto comprese - sono di proprietà Euro-Fer. La riproduzione, anche parziale, è vietata in ogni forma e con ogni mezzo. / Every part of this catalogue - photos included - is Euro-Fer's property. All forms of copying are strictly prohibited.

SPESSORE / THICKNESS mm 4 - 6



1000x120 mm  
LG001.40/10.FE  
LG001.60/10.FE



1000x100 mm  
LG005.40/10.FE  
LG005.60/10.FE



1200x120 mm  
LG008.40/10.FE  
LG008.60/10.FE

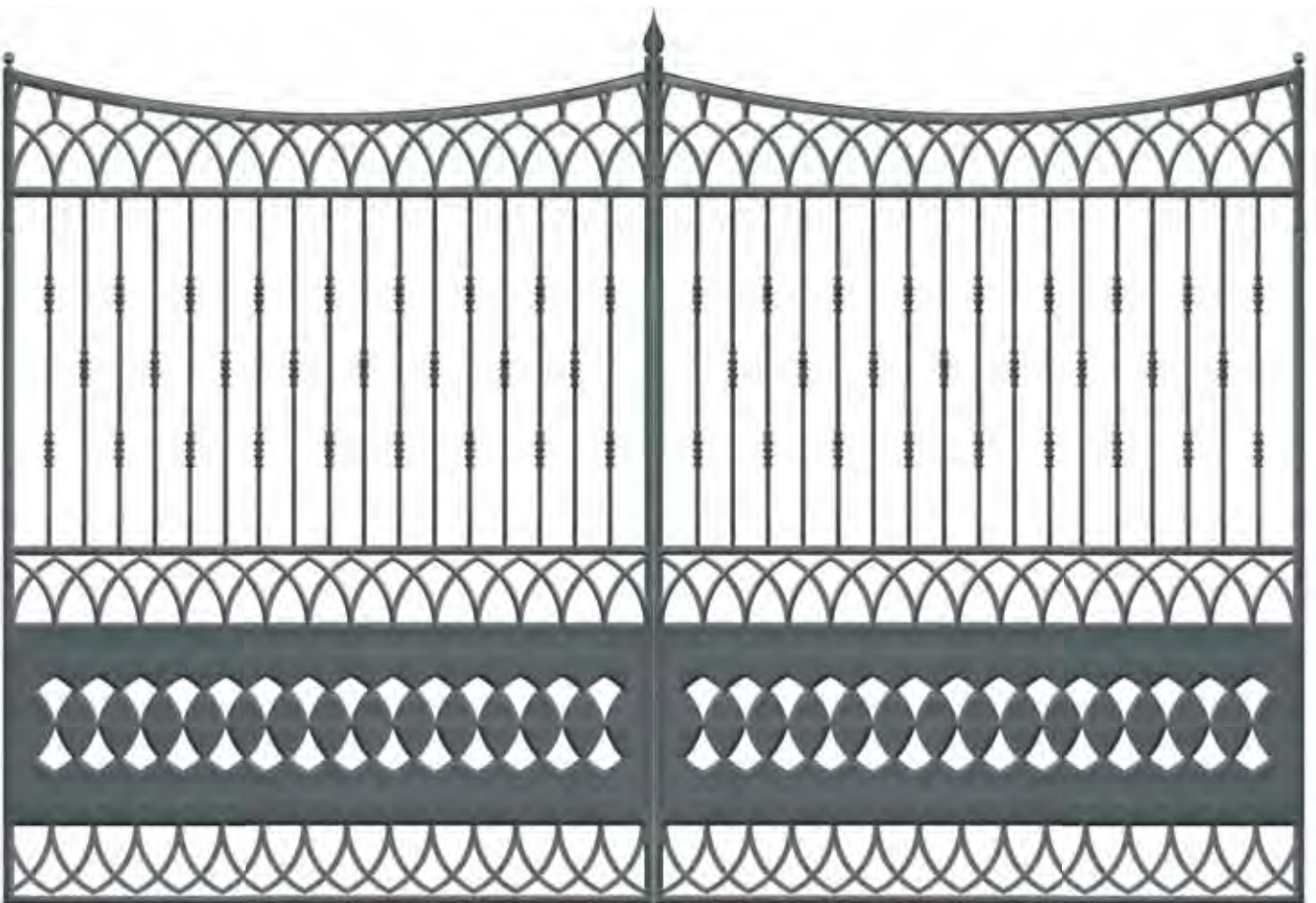

esempio / example



1200x120 mm  
LG009.40/10.FE  
LG009.60/10.FE



1200x100 mm  
LG014.40/10.FE  
LG014.60/10.FE

La fattibilità della realizzazione del decoro va verificata in base a dimensioni e spessori della lastra. / The feasibility of making certain decorations may depend on plate size and thickness.  
Tutte le parti di questo catalogo - foto comprese - sono di proprietà Euro-Fer. La riproduzione, anche parziale, è vietata in ogni forma e con ogni mezzo. / Every part of this catalogue - photos included - is Euro-Fer's property. All forms of copying are strictly prohibited.

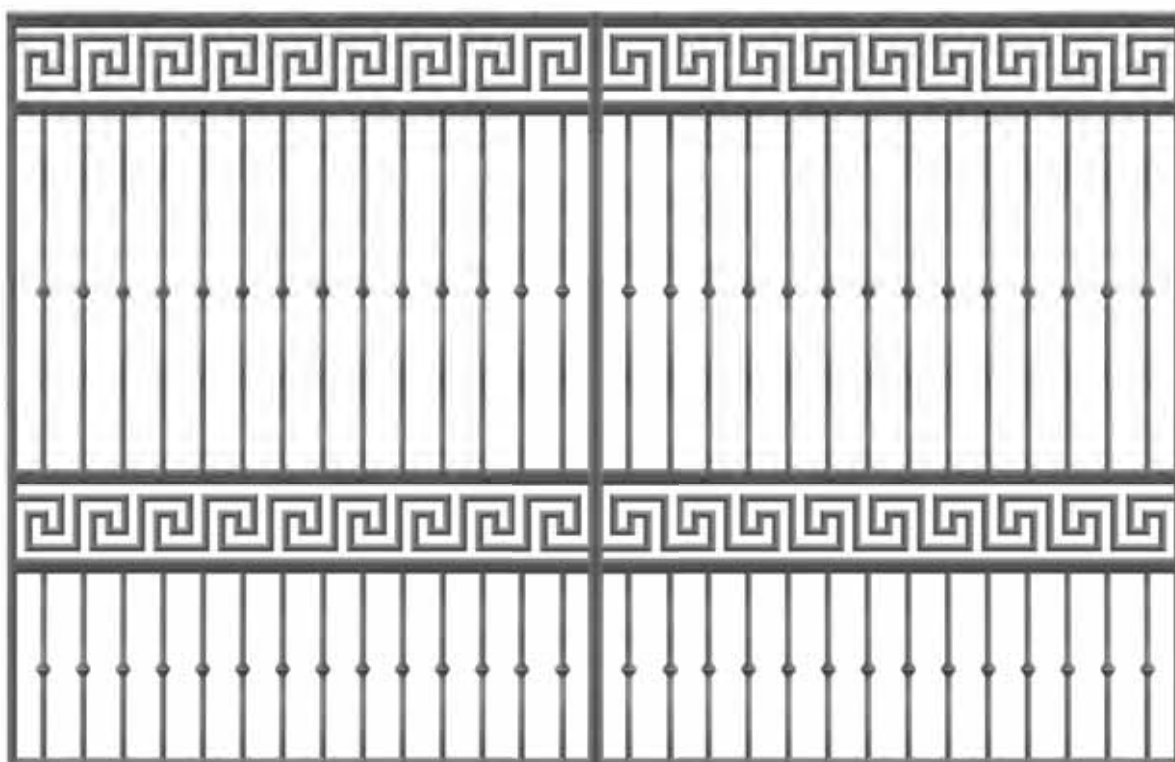

esempio / example

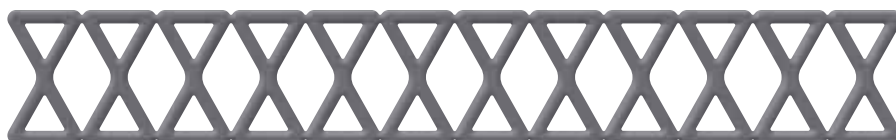
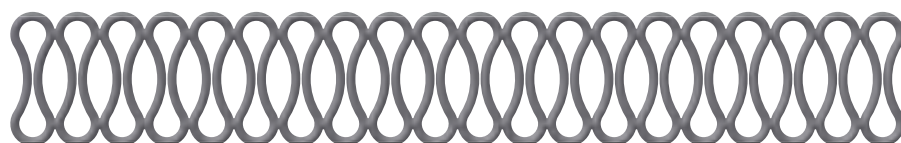

La fattibilità della realizzazione del decoro va verificata in base a dimensioni e spessori della lastra. / The feasibility of making certain decorations may depend on plate size and thickness.

Tutte le parti di questo catalogo - foto comprese - sono di proprietà Euro-Fer. La riproduzione, anche parziale, è vietata in ogni forma e con ogni mezzo. / Every part of this catalogue - photos included - is Euro-Fer's property. All forms of copying are strictly prohibited.

NEW

**CIMASE per cancelli / ORNAMENTS for carriage gates**

NEW

L

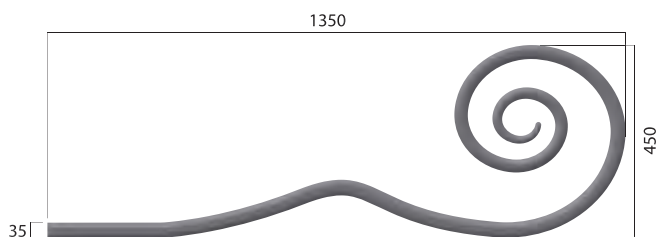

Vendute in coppia  
Sold in pairs 2 p.

LC001.40/10.FE  
LC001.60/10.FE

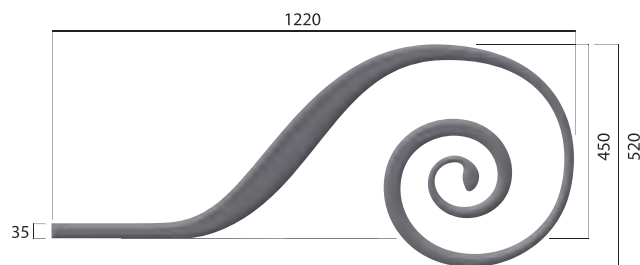

Vendute in coppia  
Sold in pairs 2 p.

LC002.40/10.FE  
LC002.60/10.FE

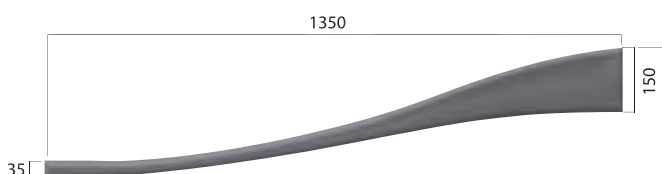

Vendute in coppia  
Sold in pairs 2 p.

LC003.40/10.FE  
LC003.60/10.FE



Vendute in coppia  
Sold in pairs 2 p.

LC004.40/10.FE  
LC004.60/10.FE

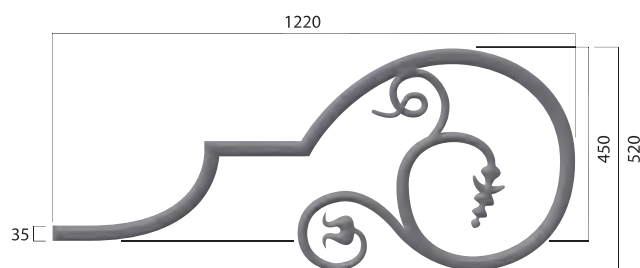

Vendute in coppia  
Sold in pairs 2 p.

LC005.40/10.FE  
LC005.60/10.FE

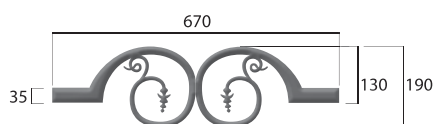

Vendute singolarmente  
Sold individually 1 p.  
LC006.40/10.FE  
LC006.60/10.FE

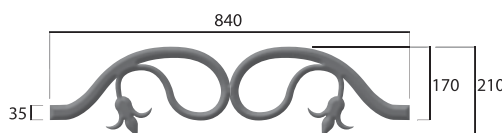

Vendute singolarmente  
Sold individually 1 p.  
LC007.40/10.FE  
LC007.60/10.FE

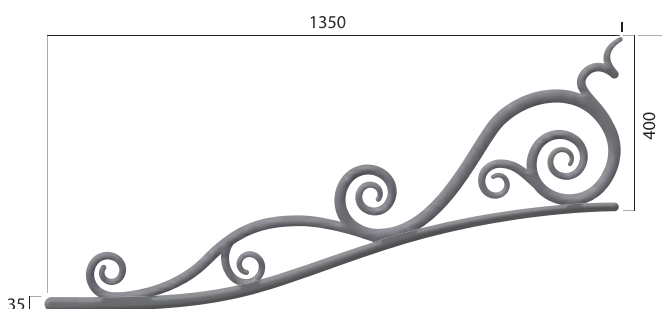

Vendute in coppia  
Sold in pairs 2 p.

LC008.40/10.FE  
LC008.60/10.FE

La fattibilità della realizzazione del decoro va verificata in base a dimensioni e spessori della lastra. / The feasibility of making certain decorations may depend on plate size and thickness.  
Tutte le parti di questo catalogo - foto comprese - sono di proprietà Euro-Fer. La riproduzione, anche parziale, è vietata in ogni forma e con ogni mezzo. / Every part of this catalogue - photos included - is Euro-Fer's property. All forms of copying are strictly prohibited.



**Art. 1000**  
**Arte dal ferro / Art of wrought iron**  
 1300 articoli / articles  
 2700 variazioni di sezioni e di altezze /  
*different sections and heights*  
 50 disegni di composizioni dimostrative  
 / *design of possible creations*



**Art. 2000**  
**Le creazioni Euro-Fer**  
*Euro-Fer creations*  
 circa 1000 articoli / articles  
 2400 variazioni di sezioni e di altezze /  
*different sections and heights*  
 oltre 100 foto di realizzazioni / *more than*  
 100 foto of creations



**Art. 4000**  
**Le forme del ferro**  
*The shapes of iron*



**Art. 4100**  
**Tra ferro e fuoco**  
*Between iron and fire*



**Art. 5000**  
**Quaderni 01 2005**



**Art. 5001**  
**Quaderni 02 2005**

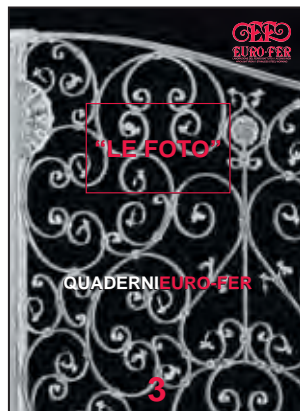

**Art. 5002**  
**Le foto**

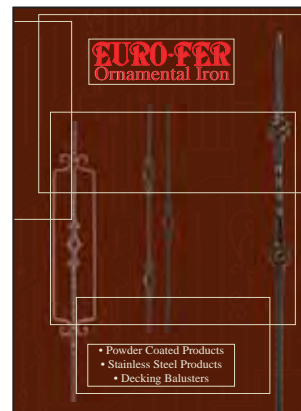

**Art. 10000**  
**Powder coated products**



**Art. 00EZ**  
**EZ Inox**  
 Ez-inox: l'inox facile  
*Ez-inox: easy inox*



**Art. 9000**  
**Cancelli Linear e Gradius**  
 Moduli zincati pronti per  
 l'installazione *Galvanized modules*  
 ready to use

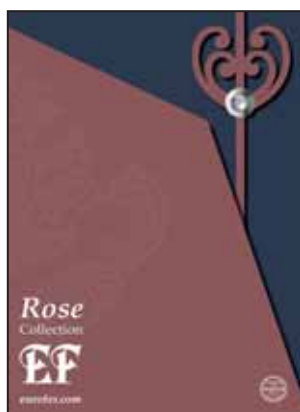

**Art. 11000**  
**Rose Collection**  
 Collezione Rose realizzata in ferro battuto  
 o in acciaio inox con inserti di cristallo,  
 utilizzo per interni. / *Indoor collection*  
 Rose, an innovative combination between  
 ornamental wrought iron, or stainless  
 steel products, made with crystal inserts.



**Art. 7003**  
**La produzione completa**  
*The whole production*

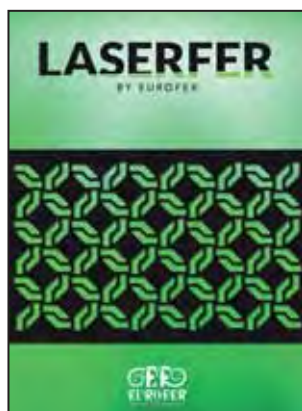

**Art. 8000**  
**Laserfer**

**COLLAGE.01**  
 Collage 1.0 è un'applicazione nata per  
 la creazione di composizioni grafiche  
 e la generazione della distinta relativa  
 agli articoli Euro-Fer scelti dall'archivio  
 fornito. / *Collage 1.0 is an application*  
 created to produce graphic compositions  
 using Euro-Fer's products.



Tutte le parti di questo catalogo –foto, disegni, testi e grafica- sono di proprietà Euro-Fer®. La loro riproduzione, pubblicazione, trasmissione, duplicazione e comunicazione anche solo parziale sono vietate in ogni forma e con ogni mezzo salvo espressa autorizzazione di Euro-Fer® spa.

Dati, foto e caratteristiche tecniche non sono impegnativi. Euro-Fer® si riserva il diritto di apportare modifiche che riterrà opportune per migliorare i suoi prodotti.

Euro-Fer® è un marchio registrato. Tutti i diritti riservati.

*All the parts of this catalogue –photos, drawings, designs and texts- are Euro-Fer® spa property. Their partial or total publication, transmission, copy, communication or other duplication are forbidden without special consent by Euro-Fer® spa.*

*Data, photos and technical characteristics are not binding. Euro-Fer® reserves the right to change the content of this catalogue without notice.*

*Euro-Fer® is a registered trademark. All rights reserved.*



Euro-Fer è un'azienda amica dell'ambiente e alimenta gran parte del ciclo produttivo con energia solare.

*Euro-Fer is an environmentally-friendly company that uses solar energy in most of its production cycle.*

# EUROFER®

LAVORAZIONE DEL FERRO BATTUTO & ACCIAIO INOX  
WROUGHT IRON & STAINLESS STEEL WORKING

**EURO-FER S.p.A.**

Viale dell'Industria, 16/18  
Castelgomberto (Vicenza) Italy

tel +39 0445 440033

fax +39 0445 440351

e-mail [eurofer@eurofer.com](mailto:eurofer@eurofer.com)

 EuroFer S.P.A.

 euroferspa

 Euro-Fer  
Euro-Fer Rose

[www.eurofer.com](http://www.eurofer.com)



[www.rosecollection.it](http://www.rosecollection.it)

