



**arteferro**<sup>®</sup>  
italian wrought iron

QUICK



IT  
EN

- LONG BARS  
BARRE LUNGHE
- PIERCED BARS  
SHAPED BARS  
BARRE FORATE  
BARRE SAGOMATE
- OVERTHROWS  
CIMASE
- CLASSICAL PICKETS  
AND PANELS  
PALETTI E PANNELLI  
CLASSICI
- MODERN PICKETS  
AND PANELS  
PALETTI E PANNELLI  
MODERNI
- BOWED PICKETS  
PANCIONI
- PICKETS FOR FENCING  
PALETTI PER RECINZIONE
- SPEAR POINTS  
AND POST TOPS  
LANCE, POMOLI E  
TERMINALI A COLONNA
- ROSACES  
ROSONI
- RINGS  
CERCHI
- SCROLLS AND  
SNAP-ONS  
RICCI E SNAP-ONS
- SPHERES  
SFERE
- BUSHES  
BORCHIE
- BASKETS  
PIGNE
- FLOWERS AND  
ROSETTES  
FIORI E ROSETTE
- DECORATIONS IN  
STEEL SHEET  
DECORI IN LAMIERA
- PLATES AND  
ACCESSORIES  
PIASTRE E  
ACCESSORI
- TOOLS  
UTENSILI

Vol.  
04





# arteferro<sup>®</sup> QUICK

italian wrought iron

**Arteferro Quick** is the new catalogue dedicated to a special selection of Arteferro items, extracted from the well-known Compendium Ind.i.a.

We've called Arteferro "Quick" because its quick and easy to use, thanks to the improved organisation of products, which has been supplemented with a lot of useful technical information.

**Arteferro Quick** è il nuovo catalogo dedicato ad una speciale selezione di articoli Arteferro, estratta dal noto Compendium Ind.i.a.

L'abbiamo chiamato Arteferro "Quick" proprio perché è veloce e rapido da utilizzare, grazie alla migliorata organizzazione dei prodotti, arricchita con molte informazioni tecniche utili.



Not all of the Arteferro items are available in **Arteferro Quick**, just a special selection. Find out about the entire range in the catalogue.

In **Arteferro Quick** non sono presenti tutti gli articoli Arteferro, ma solo una speciale selezione. Scopri la gamma completa nel catalogo *Compendium*.



Copyright © 2018 Ind.i.a. spa. Tutti i diritti riservati. Domanda di marchio, design o brevetto depositata/ registrazione o brevetto rilasciato in uno o più paesi.  
Per ulteriori informazioni, non esitare a contattarci a [info@arteferro.com](mailto:info@arteferro.com).  
Copyright © 2018 Ind.i.a. spa. All rights reserved. Trademark, design or patent application pending/ registration or patent granted in one or more countries.  
For additional information, please contact us at [info@arteferro.com](mailto:info@arteferro.com).



**Arteferro** is a division of Ind.i.a. Spa dedicated to the production of semi-finished elements in wrought iron, brass and bronze. The Arteferro product line includes over 32,000 semi-finished ornamental items made of wrought iron, brass, and bronze: pierced bars, forged pickets, pre-assembled panels, leaves, flowers, baskets, roses, scrolls, rings, and other decorative elements, as well as a rich variety of home furnishings. It is the task of blacksmiths to assemble them into finished objects such as railings, fences, or any other creation suggests his creativity. Arteferro also includes the **Gonzato Design** product line, which is characterized by an elegant and innovative style.

**Arteferro** è la divisione di **Ind.i.a. spa** dedicata alla produzione di elementi semilavorati in ferro battuto, ottone e bronzo. La gamma di prodotti Arteferro comprende oltre 32.000 elementi: barre forate, paletti forgiati, pannelli preassemblati, foglie, fiori, pigne, rosoni, ricci, cerchi ed altri componenti decorativi, oltre ad una ricca serie di complementi d'arredo. Sarà compito del fabbro assemblarli in oggetti finiti come parapetti, recinzioni o qualsiasi altra creazione gli suggerisca la sua creatività. Arteferro comprende anche la linea di prodotti **Gonzato Design**, caratterizzata da uno stile elegante ed innovativo.

## THE BEST IN WROUGHT IRON IL MEGLIO DEL FERRO BATTUTO



### A small, but massive revolution!

The **Arteferro Quick** catalogue has been specifically organised to facilitate the search for individual items. First of all, the **structural elements**, like long bars, pierced bars and overthrows, then **filling elements**, like pickets, panels and rosettes, and then passing onto **decorative elements** like scrolls, circles, spheres and many others. At the end, you'll find the **accessories** and **tools** for construction site activities.

### una piccola grande rivoluzione!

Il catalogo **Arteferro Quick** è stato organizzato appositamente per agevolare la ricerca di ogni elemento. Prima gli **elementi strutturali**, come le barre lunghe, le barre forate e le cimase, poi gli **elementi di tamponamento**, come i paletti, i pannelli, rosoni, per passare agli **elementi decorativi** come i ricci, i cerchi, le sfere e molti altri. Infine si troveranno gli **accessori** e gli **utensili** per l'attività di cantiere.

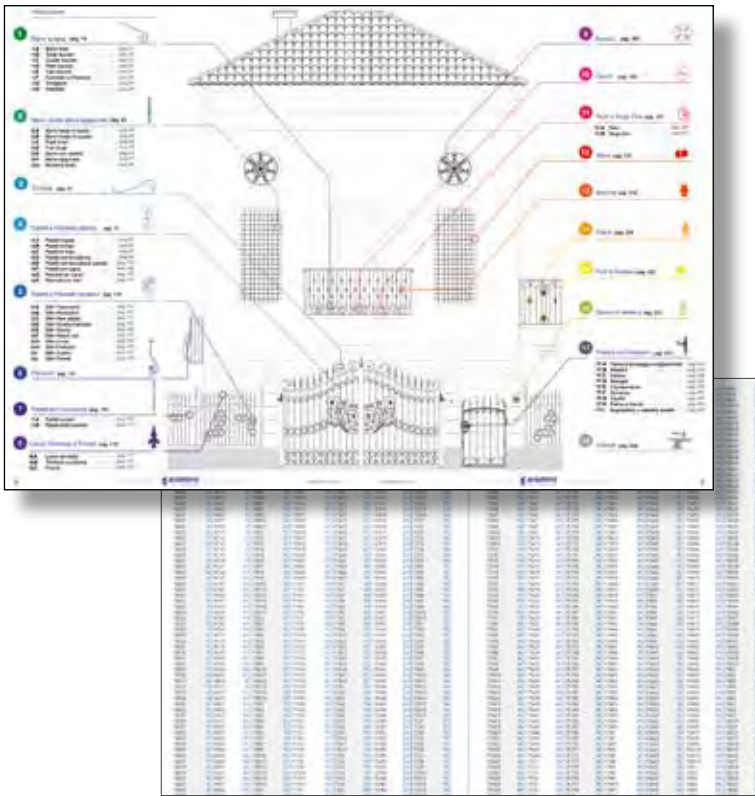

## Find what you're looking for straight away

In addition to an **index by product code**, which is easy for loyal customers who know well our elements, we have created a new index by type of product, which makes any search fast and intuitive. In fact, every product line has been organised into sections and, for the most complex ones, specific sub-sections have been created, based on the processing, cross-sections, styles and types of element. To improve the consultation process, some sections have been reorganized and, among these, the section dedicated to **posts** has been integrated into the one for pickets and panels.

## Trovi subito quello che cerchi

Oltre all'**indice per codice prodotto**, facile da consultare da tutti i nostri affezionati clienti che ben conoscono i nostri articoli, abbiamo ideato un nuovo **indice per tipologia di prodotto**, che rende ogni ricerca rapida ed intuitiva. Ogni linea di prodotto infatti è stata organizzata in capitoli e, per le più articolate, sono stati creati degli appositi sotto capitoli in base alla lavorazione, alla sezione, allo stile, alla tipologia degli elementi. Per una miglior consultazione sono stati riorganizzati alcuni capitoli e, tra questi, quello dedicato ai **capisaldi** è stato integrato in quello dei paletti e pannelli.

## New products

Our designers are always at work! In Arteferro Quick, you'll find many new articles highlighted with a specific seal. With a classic or modern design, they're always characterized by the unique and unmistakable Arteferro style.

## Nuovi prodotti

I nostri designer sono sempre all'opera! In Arteferro Quick troverai tanti nuovi articoli evidenziati dall'apposito bollino. Dal design classico o moderno sono comunque sempre caratterizzati dallo stile Arteferro, unico ed inconfondibile.

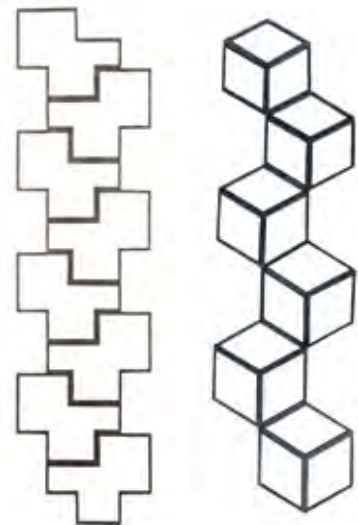

## Easy to flip through

At the beginning of each section, on the focused cover, a description helps understand its content. Thanks to the renewed graphics it will be very easy to find the item you are looking for. In the more complex sections easy instructions will help you to better understand how they are organised.

## Facile da sfogliare

All'inizio di ogni capitolo, sulla copertina dedicata, un testo descrittivo aiuta a capire cosa troverai all'interno. Grazie alla grafica rinnovata sarà un gioco da ragazzi individuare l'articolo che ti interessa. Nei capitoli più complessi abbiamo riportato delle facili istruzioni che ti aiuteranno nel comprendere la logica dell'organizzazione.



# Amongst the pages, a huge amount of useful information

Created afresh, based on over forty years of experience in the industry, **Arteferro Quick** wants to become a really easy to use and intuitive work tool for you to consult, by virtue of its new logical layout, which enables you to find the product of interest straight away, to pass quickly from one family of articles to another, and then to go into the details with sizes and finishes.

# Tra le pagine molte informazioni utili

Realizzato ex novo, sulla base di un'esperienza ultra quarantennale nel settore, **Arteferro Quick** vuole diventare un vero e proprio strumento di lavoro facile ed intuitivo da consultare, in virtù della nuova ragionata impaginazione che consente di trovare immediatamente il prodotto di interesse, passando celermente tra le famiglie di articoli, per poi entrare nel dettaglio con il dimensionamento e le finiture.

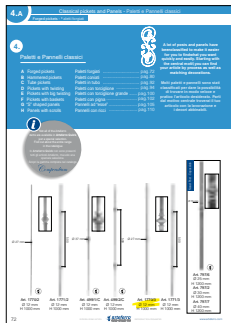

**4.** Classical pickets and Panels  
Paletti e Pannelli classici

A Forged pickets	Paletti forgiati	pag.72
B Hammered pickets	Paletti coniati	pag.80
C Tube pickets	Paletti in tubo	pag.82
D Pickets with twisting	Paletti con torciglione	pag.94
E Pickets with big twisting	Paletti con torciglione grande	pag.100
F Pickets with baskets	Paletti con pigna	pag.102
G "S" shaped panels	Pannelli ad "esse"	pag.105
H Panels with scrolls	Pannelli con ricci	pag.110

A lot of pickets and panels have been classified to make it easier for you to find what you want quickly and easily. Starting with the central motif, you can find your article by process as well as matching decorations.

Molti paletti e pannelli sono stati classificati per dare la possibilità di trovare in modo veloce e pratico l'articolo desiderato. Parti dal motivo centrale troverai il tuo articolo con la lavorazione e i decori abbinabili.

## Starting Section box

A quick overview about how to deal with the specific section

## Riquadro di inizio capitolo

Rapida panoramica su come affrontare il capitolo specifico

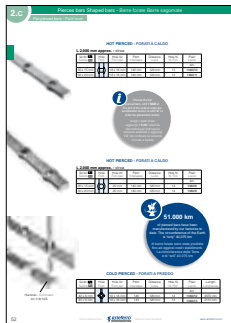

**51.000 km**

of pierced bars have been manufactured by our factories to date. The circumference of the Earth is "only" 40,075 km

di barre forate sono state prodotte fino ad oggi nei nostri stabilimenti. La circonferenza della Terra è di "soli" 40.075 km

## Blue Circle

useful and interesting information about our elements.

## Cerchio blu

notizie utili e curiosità sui nostri articoli

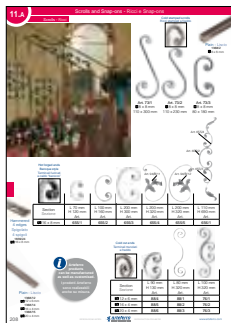

**i** Arteferro products can be manufactured as well as customised.

I prodotti Arteferro sono realizzabili anche su misura.

## Grey Circle

technical information and stylistic advice from our experts

## Cerchio grigio

informazioni tecniche e consigli stilistici dei nostri esperti



## Highlights

identify the featured articles

## Highlights

identifica gli articoli in evidenza



Articles of the Gonzato Design line  
articoli della linea Gonzato Design



new items  
articoli nuovi



items that are the intellectual property of Ind.i.a. spa  
articoli di proprietà intellettuale di Ind.i.a. spa



special price items  
articoli a prezzo speciale

**Gonzato Design** è la linea di prodotti Arteferro caratterizzata da uno stile innovativo. I motivi classici del ferro battuto si fondono e dialogano con le geometrie moderne dando vita ad un insieme unico che parla di passato e futuro. Le linee in stile Classico di inizio '900 sono mediate con una sensibilità contemporanea che razionalizza lo spazio e lo rende elegante e preciso.

Tra gli articoli Gonzato Design anche i **pannelli pre-assemblati** che, pronti per l'installazione, sono pensati per facilitare il lavoro dell'artigiano: basta unirli tra loro o accoppiarli a dei semplici paletti di ferro liscio per realizzare la propria composizione. Una soluzione di design e pratica che consente un notevole risparmio di tempo e denaro. Come tutti i prodotti Arteferro anche i pannelli pre-assemblati possono esser prodotti anche **anche su misura**.

The **Gonzato Design** product line by Arteferro is set apart by its innovative style. The classical wrought iron motifs interact with modern geometry, creating a unique combination of past and future. The lines, inspired by the Classic style of the early 1900s, are mediated with a contemporary awareness, rationalising space and making it elegant and precise.

The Gonzato Design range also includes **preassembled panels**, ready for installation, designed to facilitate the work of the craftsman: just join them together or connect them to simple plain iron pickets to make your own arrangement. A practical design solution that allows for considerable savings in terms of both time and money. Like all Arteferro products, the pre-assembled panels can also be custom-made.



**GONZATO  
DESIGN**  
FINE WROUGHT  
IRON FORGINGS

The Gonzato Design product line by Arteferro has been expanded with many new items and combined together into families: Geometric, Revolution, New Waves and much more to be discovered!

La linea di prodotti Gonzato Design by Arteferro è stata ampliata con tanti nuovi articoli e raggruppata in famiglie: Geometric, Revolution, New Waves e tante altre tutte da scoprire!

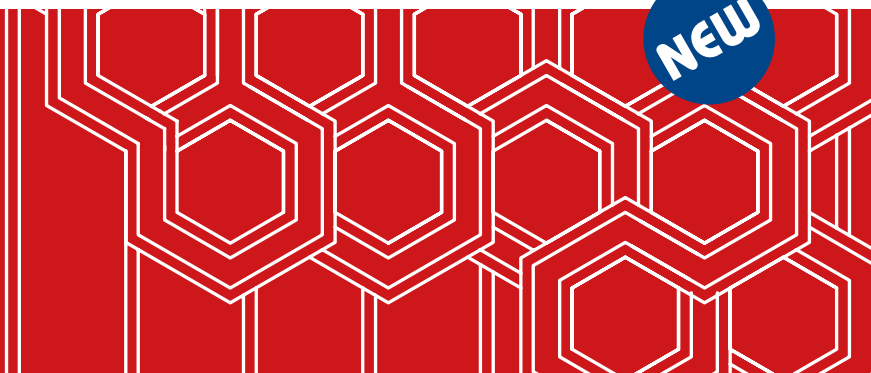

## Why choose the Gonzato Design products? Perché scegliere i prodotti Gonzato Design?



Exclusive and patented design  
Design esclusivo e brevettato



Welding and production quality  
Saldature e lavorazioni di alta qualità



Easier and quicker installation than traditional pickets  
Installazione più facile e più veloce rispetto ai classici paletti



High value-added to your final product  
Alto valore aggiunto al tuo manufatto finale



Excellent value for money  
Eccellente rapporto qualità-prezzo



Ideal for installations in modern contexts  
Ideale per installazioni in contesti moderni

Discover more about Gonzato Design line, visit - Scopri di più sul mondo Gonzato Design visita [www.gonzatodesign.com](http://www.gonzatodesign.com)





With 20 companies spread throughout the world, Gonzato Group is the leader in production of semi-finished products and modular systems in metal for construction and architecture. Its products, distributed in 136 countries, have been chosen to protect and adorn some of the most important buildings in the world, including: the palace of Justice and the Colosseum in Rome, the park Terenure in Dublin, Disneyland in Paris, and many other prestigious villas and residences in St.Petersburg, passing through London, Beijing, and Saint Tropez.

Con 20 società, sparse in tutto il mondo, Gonzato Group è leader nella produzione e distribuzione di semilavorati e sistemi modulari in metallo per l'edilizia e l'architettura. I suoi prodotti, distribuiti in 136 paesi, sono stati scelti per proteggere ed adornare alcuni dei più importanti edifici e complessi mondiali, tra i quali il palazzo di Giustizia ed il Colosseo di Roma, Il parco Terenure di Dublino, Disneyland a Parigi e molte altre prestigiose ville e residenze da Hollywood a San Pietroburgo, passando per Londra, Pechino e Saint Tropez.



## A company looking towards the future.

Since 1971, we are world leader in the production and sale of ornamental components for the building industry and architecture. All our products are the result of careful and passionate research by qualified experts that know the field better than anyone else. In fact, it is thanks to the Group's work in the production of metal elements for architecture and constructions has been able to grow in terms of technology and project management to become what it is now.

The experience acquired in over 40 years of work in the field of wrought iron allowed us to develop in the last 15 years the same deep knowledge in the field of stainless steel and of its fencing applications. As a matter of fact, our IAM Design line, while being more technical and stylized compared to the Arteferro components, meets the same needs of safety, support and decoration that we have always well known.

In the Group's catalogues you will find more than 30.000 fencing and furniture components always ready to use and ready to be dispatched. Thanks to our long experience, that involves all the production and supply chain from product design to manufacturing, to the installation support, we are the sole company in the world who is able to realize and install anywhere big fencing structures, relying upon our know how and the practical sense of our designers and members of our team.

## Un'azienda rivolta al futuro.

Dal 1971 siamo leader mondiali nella produzione e commercializzazione di semilavorati ornamentali per l'architettura. Tutti i prodotti sono frutto di studi attenti ed appassionati da parte di professionisti specializzati che conoscono il settore meglio di chiunque altro. Infatti è grazie alla attività del Gruppo che la produzione nel settore ha potuto svilupparsi tecnologicamente e progettualemente fino a diventare quel che è oggi.

L'esperienza maturata in oltre 40 anni di ferro battuto, ha consentito di sviluppare un altrettanto approfondita conoscenza dell'acciaio inox e dei suoi utilizzi nella recinzione. IAM Design, propone soluzioni più tecniche e stilizzate, mentre i manufatti in ferro battuto di Arteferro hanno caratteristiche di maggiore varietà ornamentale ma entrambe le linee di prodotti assolvono sempre a quelle stesse esigenze di protezione, sostegno e decorazione che ben conosciamo da sempre.

Nei cataloghi del Gruppo sono presenti oltre 32.000 manufatti per recinzioni ed arredamento, sempre pronti all'uso ed alla consegna. Grazie a questa esperienza pluridecennale che coinvolge tutta la filiera dalla produzione siderurgica, al design dei prodotti, alla loro realizzazione, all'installazione, siamo anche gli unici al mondo capaci di ideare con architetti e sviluppatori oltre che di realizzare ovunque grandi opere, forti del know how e della praticità dei nostri progettisti e operatori.

World market leader

- a 5 continents' leadership
- exports to 136 countries
- a product range of over 32,000 items

Certifications

- ISO 9001 - Quality Management
- ISO 14001 - Environmental Management

Leader di mercato

- leadership nei 5 continenti
- presenza in 136 stati
- gamma di oltre 32.000 articoli

Certificazioni

- ISO 9001 - Gestione della Qualità
- ISO 14001 - Gestione Ambientale

## An ever growing presence

- 20 companies in 5 continents and headquarter in Italy
- 4 production sites totalling
- 64.000 m<sup>2</sup> of warehousing and production.
- Over 700 employees and collaborators
- 4.100 ton./month shipped
- 40 million pieces of ready made components sold per year
- Over 2000 stockist customers served, in 136 different Countries
- Over 32,000 components available on stock

## Una realtà in continua crescita.

- 20 aziende in 5 continenti con headquarter in Italia
- 4 stabilimenti produttivi
- 64.000 m<sup>2</sup> coperti
- Oltre 700 tra dipendenti e collaboratori
- 4.100 ton./mese spedite
- 40 milioni di semilavorati venduti mediamente in un anno
- Oltre 2000 clienti grossisti in 136 Stati nel mondo;
- Oltre 32.000 articoli diversi a stock



# HIGHLIGHTS

<p>PAG.199 <b>11.A</b></p>  <p>Art. 80/A/3</p>	<p>PAG.117 <b>5.A</b></p>  <p>Art. GD301/2</p>	<p>PAG.178 <b>8.A</b></p>  <p>Art. 725/1</p>
<p>PAG. 214 <b>11.A</b></p>  <p>Art.94/F/3</p>	<p>PAG.133 <b>5.D</b></p>  <p>Art.GD300/2</p>	<p>PAG.34 <b>1.F</b></p>  <p>Art. 114/4</p>
<p>PAG.144 <b>5.G</b></p>  <p>Art.GD282/2</p>	<p>PAG.70 <b>3</b></p>  <p>Art. GD271/3</p>	<p>PAG.159 <b>6</b></p>  <p>Art.1276/1</p>
<p>PAG.122 <b>5.B</b></p>  <p>Art.GD289/2</p>	<p>PAG.162 <b>7.A</b></p>  <p>Art.1757/43</p>	<p>PAG.247 <b>17.A</b></p>  <p>Art.F0222</p>
<p>PAG.45 <b>2.B</b></p>  <p>Art.1361/3</p>	<p>PAG.53 <b>2.D</b></p>  <p>Art.1852/67</p>	<p>PAG.126 <b>5.B</b></p>  <p>Art.GD295/1</p>



# HIGHLIGHTS

<p>PAG.46 <b>2.B</b></p>  <p>Art. GD124/7</p>	<p>PAG.90 <b>4.B</b></p>  <p>Art. 1718/9</p>	<p>PAG.177 <b>8.A</b></p>  <p>Art. 126/A/2</p>
<p>PAG.189 <b>9</b></p>  <p>Art. GD268/2</p>	<p>PAG.104 <b>4.F</b></p>  <p>Art. 801/3</p>	<p>PAG.182 <b>8.B</b></p>  <p>Art. 1400/1</p>
<p>PAG.116 <b>5.A</b></p>  <p>Art. GD287/1</p>	<p>PAG.25 <b>1.E</b></p>  <p>Art. 1374/2/S1</p>	<p>PAG.205 <b>11.A</b></p>  <p>Art. 1308/8</p>
<p>PAG.98 <b>4.D</b></p>  <p>Art. 1688/3</p>	<p>PAG.246 <b>17.A</b></p>  <p>Art. F085700</p>	<p>PAG.89 <b>4.B</b></p>  <p>Art. 1730/4</p>
<p>PAG.174 <b>8.A</b></p>  <p>Art. 1854/9</p>	<p>PAG.120 <b>5.B</b></p>  <p>Art. GD302/2</p>	<p>PAG.235 <b>15</b></p>  <p>Art. 136/1</p>

**1** Long bars  
Barre lunghe pag. 15

<b>1.A</b> Plain bars	Barre lisce .....	pag.17
<b>1.B</b> Decorative round bars	Tondi lavorati .....	pag.19
<b>1.C</b> Decorative square bars	Quadri lavorati .....	pag.20
<b>1.D</b> Decorative flat bars	Piatti lavorati .....	pag.22
<b>1.E</b> Hammered edges tubes	Tubi lavorati .....	pag.24
<b>1.F</b> Handrails and End pieces	Corrimani e Partenze .....	pag.26
<b>1.G</b> Twisted bars	Torciglioni .....	pag.36
<b>1.H</b> Collars	Fascette .....	pag.38

**2** Pierced bars - Shaped bars  
Barre forate - Barre sagomate pag. 43

<b>2.A</b> Round pierced bars	Barre forate in tondo .....	pag.44
<b>2.B</b> Square pierced bars	Barre forate in quadro .....	pag.45
<b>2.C</b> Flat punched bars	Piatti forati .....	pag.48
<b>2.D</b> Punched tubes	Tubi forati .....	pag.53
<b>2.E</b> Pierced posts	Montanti forati .....	pag.54
<b>2.F</b> Bars with stamped rivets	Barre con ribattini stampati .....	pag.56
<b>2.G</b> Shaped bars	Barre sagomate .....	pag.58

**3** Overthrows  
Cimase pag. 61

**4** Classical Pickets and Panels  
Paletti e Pannelli classici pag. 71

<b>4.A</b> Forged pickets	Paletti forgiati .....	pag.72
<b>4.B</b> Stamped pickets	Paletti conati .....	pag.80
<b>4.C</b> Tube pickets	Paletti in tubo .....	pag.92
<b>4.D</b> Pickets with twisting	Paletti con torciglione .....	pag.94
<b>4.E</b> Pickets with big twisting	Paletti con torciglione grande .....	pag.100
<b>4.F</b> Pickets with baskets	Paletti con pigna .....	pag.102
<b>4.G</b> "S" shaped panels	Pannelli ad "esse" .....	pag.105
<b>4.H</b> Panels with scrolls	Pannelli con ricci .....	pag.110

**5** Modern pickets and Panels  
Paletti e Pannelli moderni pag. 113

<b>5.A</b> Geometric Style	.....	pag.114
<b>5.B</b> Linear Style	.....	pag.120
<b>5.C</b> Floreal Style	.....	pag.129
<b>5.D</b> Waves Style	.....	pag.132
<b>5.E</b> Impero Style	.....	pag.135
<b>5.F</b> Revolution Style	.....	pag.137
<b>5.G</b> New Classic Style	.....	pag.141
<b>5.H</b> New Liberty Style	.....	pag.148

**6** Bowed pickets  
Pancioni pag. 151

**7** Pickets for fencing  
Paletti per recinzione pag. 161

<b>7.A</b> Stamped pickets	Paletti conati .....	pag.162
<b>7.B</b> Electrowelded pickets	Paletti elettrosaldati .....	pag.171

**8** Spear points and Post tops  
Lance, Pomoli e Terminali a colonna pag. 173

<b>8.A</b> Spear points	Lance terminali .....	pag.174
<b>8.B</b> Tops	Pomoli .....	pag.181
<b>8.C</b> Post tops	Terminali a colonna .....	pag.183

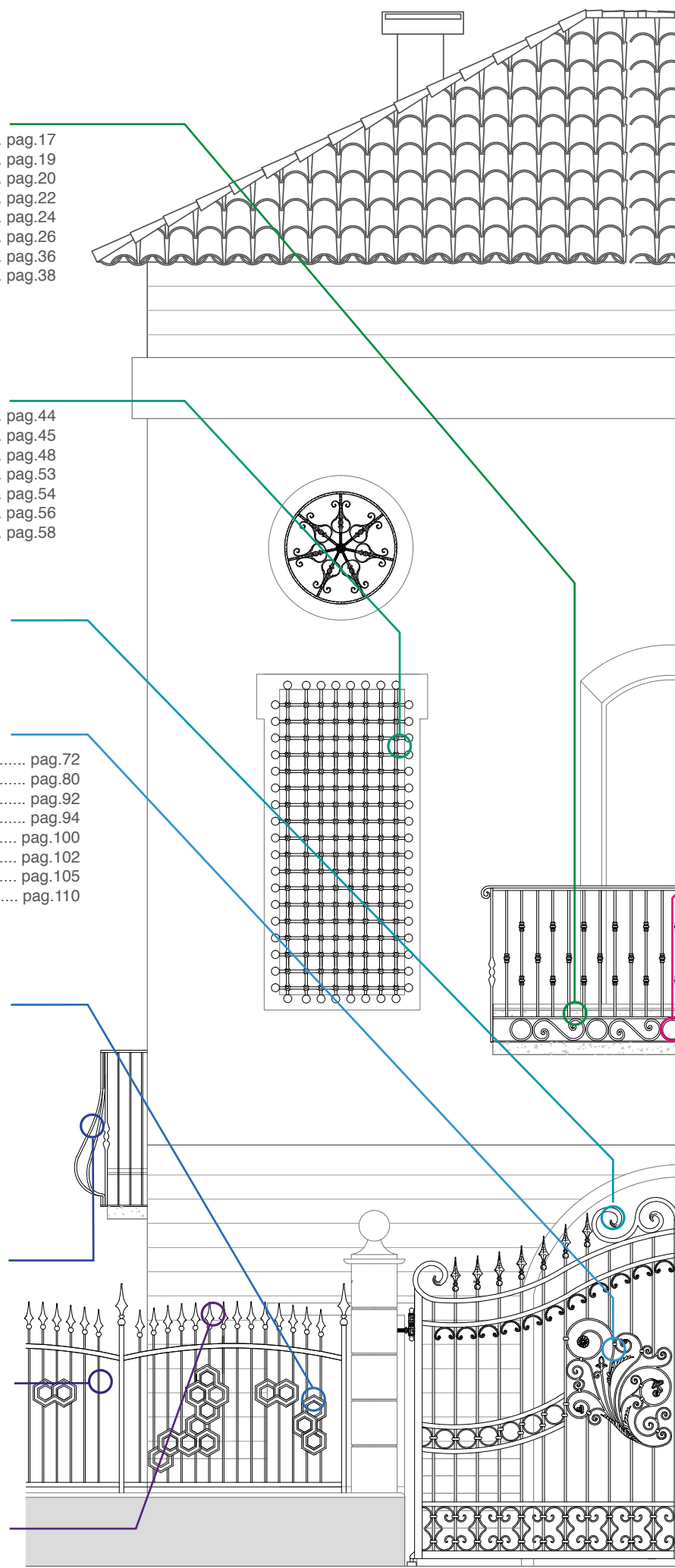

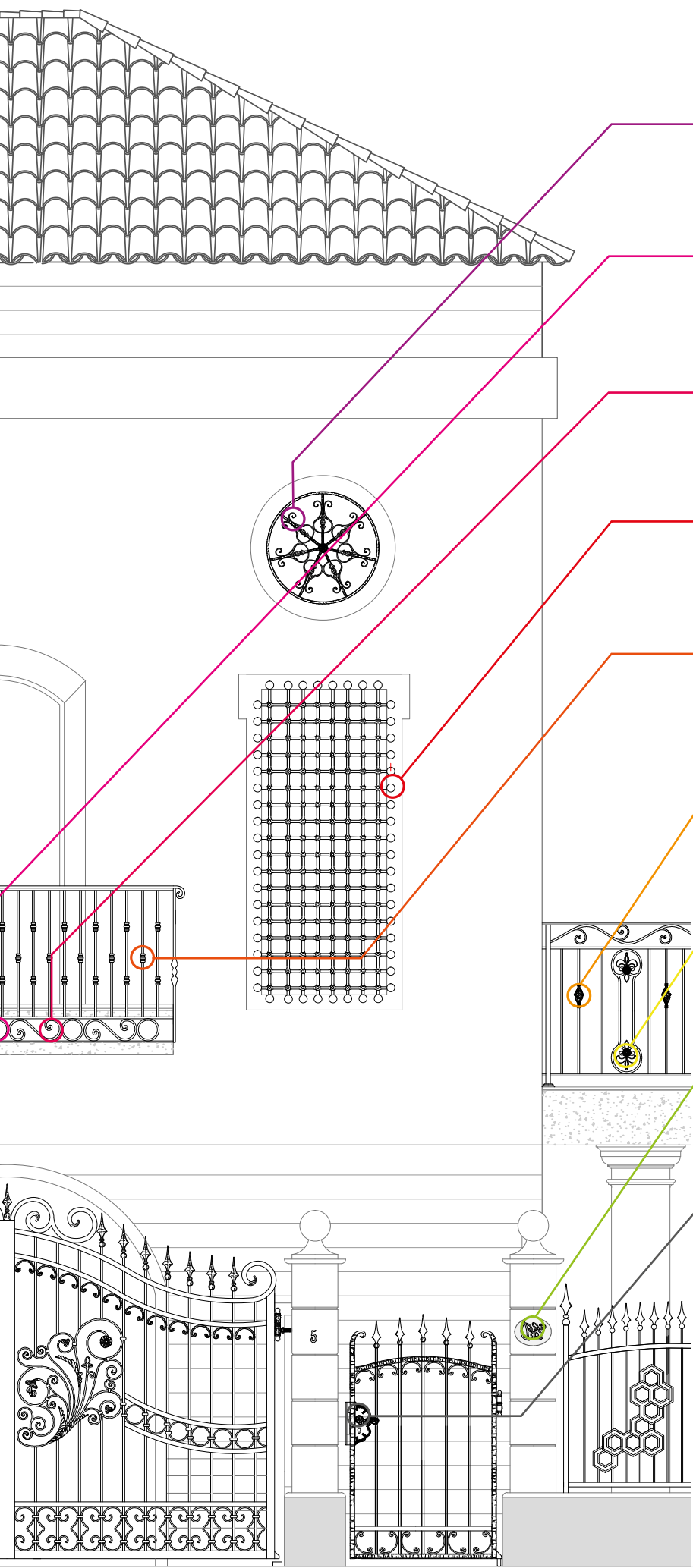

**9** Rosaces  
Rosoni pag. 185 

**10** Rings  
Cerchi pag. 193 

**11** Scrolls and Snap-ons  
Ricci e Snap-ons pag. 197 

11.A Scrolls - Ricci ..... pag.198  
11.B Snap-ons ..... pag.215

**12** Spheres  
Sfere pag. 217 

**13** Bushes  
Borchie pag. 219 

**14** Baskets  
Pigne pag. 229 

**15** Flowers and Rosettes  
Fiori e Rosette pag. 233 

**16** Decorations in steel sheet  
Decori in lamiera pag. 237 

**17** Plates and Accessories  
Piastre ed Accessori pag. 243 

- 17.A Anchor plates - Piastre di ancoraggio pag.244
- 17.B Rivets - Ribattini ..... pag.248
- 17.C Chains - Catene..... pag.249
- 17.D Door handles - Maniglie .....pag.250
- 17.E Locks covers - Copriserratura..... pag.253
- 17.F Locks - Serrature ..... pag.254
- 17.G Hinges - Cardini..... pag.255
- 17.H Paints and varnishes - Patine e Vernici .. pag.257
- 17.I Weathervanes and Mail boxes ..... pag.258  
Segnavento e Cassette postali

**18** Tools  
Utensili pag. 259 

# Siamo qui. We are here.



1

## ITALIA - Headquarters

Ind.i.a. spa  
Via Vicenza, 6/14  
36034 - Malo  
Vicenza • Italia  
tel. +39 0445 580 580 • fax: +39 0445 580 874  
info@india.it • www.india.it



2

## U.S.A.

Indital US Ltd  
7947 Mesa Drive  
77028 - Houston  
Texas • U.S.A.  
tel. +1 713 694 6065 • fax: +1 713 694 2055  
forgings@indital.com • www.indital.com



3

## FLORIDA - CARAIBI

Arteferro Miami LLC  
2955 NW 75th Street  
33147 - Miami  
Florida • U.S.A.  
tel. +1 305 836 9232 • fax: +1 305 836 4113  
info@arteferromiami.com • www.arteferromiami.com



4

## ITALIA

Co.Ge.Me. Steel srl  
Via Enrico Fermi 34  
26041 - Casalmaggiore  
Cremona • Italia  
tel. +39 0375 284820 • fax +39 0375 203877  
info@cogemesteel.com



5

## DEUTSCHLAND

Triebenbacher Betriebsgesellschaft mbH  
Gutenbergstraße 1  
85737 Ismaning  
Deutschland  
tel. +49 (0) 89/57 09 28 50 • fax: +49 (0) 89/57 09 28 38  
info@triebenbacher.de • www.triebenbacher.de



6

## FRANCE

Ind.i.a. France Sarl  
P.A.E. la Baume, 7 Rue de l'Artisanat  
34290 - Servian  
Servian • France  
tel. +33 (0) 4 67 39 42 81 • fax: +33 (0) 4 67 39 20 90  
info@indiafrance.eu • www.indiafrance.eu



7

## HRVATSKA

Arteferro Dohomont doo  
Gospodarska 1/A  
40324 - Gorican  
Gorican • Hrvatska  
tel. +385 (0) 40 602 222 • fax: +385 (0) 40 602 230  
info@arteferro-dohomont.hr • www.arteferro-dohomont.hr



8

## ESPAÑA

Ind.i.a. España, SL  
C/ Abedul, 43 - Polig. Ind. El Guijar  
28500 - Arganda del Rey  
Madrid • España  
tel. +34 918 700 819 • fax: +34 918 700 820  
info@arteferro.es • www.arteferro.es

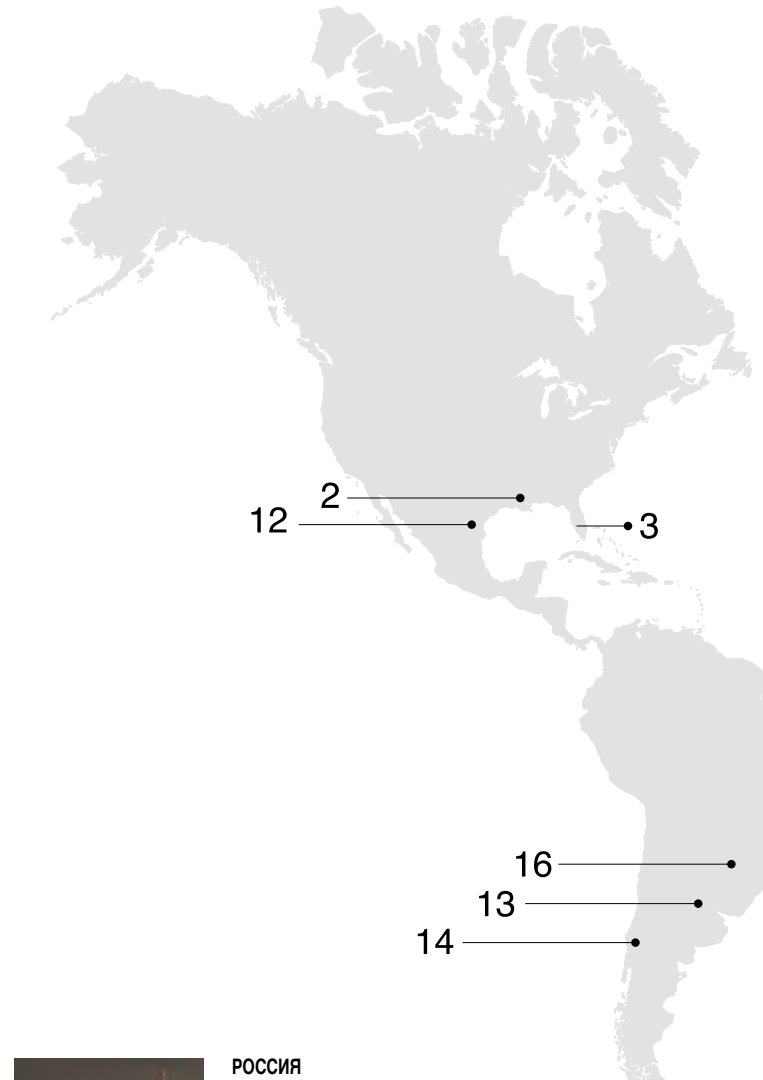

9

## РОССИЯ

ООО "АРТЕФЕРРО-РУССИЯ"  
603124, Россия, Нижний Новгород, Вторчермета 1Г  
Тел. +7-831-2621999  
info@arteferrorussia.com  
www.arteferro.ru



10

## УКРАЇНИ

Arteferro Ukraina  
Avtoparkova, 5  
02660 - Киев  
Україна  
tel. +380 44 492 03 31 • fax: +380 44 492 03 32  
office@arteferroukraine.com • www.arteferroukraine.com



11

## SVERIGE - DANMARK

Arteferro Skandinavien AB  
Röda Stugans gata 2  
602 28 - Norrköping  
Sverige  
tel. +46 (0) 11 18 23 23 • fax: +46 (0) 11182328  
info@arteferro.se • www.arteferro.se



12

## MÉXICO

Arteferro Monterrey SA de CV  
Privada la Puerta 2879 B-4  
66350 - Col. Parque Industrial - La Puerta Santa Catarina  
Nuevo Leon • México  
tel. +52 1 81 1295 5094/95 • fax: +52 1 81 1295 5097  
info@arteferromexico.com • www.arteferromexico.com



13



**ARGENTINA**

Arteferro Argentina SA  
 Suárez 760  
 1162 - Buenos Aires  
 Argentina  
 tel. +54 11 4301 2637 • fax: +54 11 4301 2637  
 info@arteferroargentina.com • www.arteferroargentina.com

14



**CHILE**

Arteferro Chile SA  
 Calle Los Arrayanes, 250, bodega 4  
 9340000 -Santiago  
 Colina • Chile  
 tel. +56 2 738 7419 • fax: +56 2 738 7419  
 arteferro@arteferrochile.cl • www.arteferrochile.cl

15



**中华人民共和国**

China (Shandong province)  
 Representative Far East  
 india@arteferro.com

16



**BRASIL**

Ind.i.a. Brasil LTDA  
 Rua Padre Feijó, 480  
 95190-000 - São Marcos  
 Rio Grande do Sul • Brasil  
 tel. +55 54 3291 1416 • fax: +55 54 3291 1416  
 Branch  
 Av. Almirante Cochrane, 194 – Sala 32  
 11040-200 – Santos - Sao Paulo • Brasil  
 tel. +55 13 21389091  
 vendas@arteferrobrasil.com.br  
 www.arteferrobrasil.com.br

## Our brands I nostri marchi

Gonzato Group manufactures and distributes exclusively the products of its brands

Gonzato Group produce e distribuisce in esclusiva le realizzazioni dei suoi marchi



The Arteferro product line includes over 32,000 semi-finished ornamental items made of wrought iron, brass, and bronze: pierced bars, forged pickets, pre-assembled panels, leaves, flowers, baskets, roses, scrolls, rings, and other decorative elements, as well as a rich variety of home furnishings. It is the task of blacksmiths to assemble them into finished objects such as railings, fences, or any other creation suggests his creativity.

La gamma di prodotti Arteferro comprende oltre 32.000 elementi semilavorati ornamentali in ferro battuto, ottone e bronzo: barre forate, paletti forgiati, pannelli preassemblati, foglie, fiori, pigne, rosoni, ricci, cerchi ed altri elementi decorativi, oltre ad una ricca serie di complementi d'arredo. Sarà compito del fabbro assemblarli in oggetti finiti come parapetti, recinzioni o qualsiasi altra creazione gli suggerisca la sua creatività.



The IAM Design product line includes more than 2,500 modular stainless steel elements to achieve railings, fences, canopies, staircases, and other structural elements, both for interior and external spaces. The modern and linear design of the various elements allows a quick and easy installation, and meets the needs of architects, designers and professionals, adapting perfectly to any type of environment.

La gamma di prodotti IAM Design comprende oltre 2.500 elementi componibili e modulari in acciaio inox per realizzare parapetti, recinzioni, pensiline, scale ed altri elementi strutturali, per interni ed esterni. Il design moderno e lineare dei vari elementi consente una facile e veloce installazione e soddisfa le esigenze di architetti, progettisti e professionisti adattandosi perfettamente ad ogni tipo di ambiente.



CO.GE.ME.Steel was founded in 1970 with a mission: to enter in quality steel manufacturing as main players, producing steel that craftsmen and industries could find perfect for their production needs.

CO.GE.ME. Steel srl nasce nel 1970 con una missione: entrare nella siderurgia di qualità da protagonisti, producendo acciaio che artigiani e industriali trovassero perfetto per le proprie esigenze produttive.

## Our turnkey services I nostri servizi "chiavi in mano"



Gonzato Contract is the division of Ind.i.a. that works with special supplies, in wrought iron, stainless steel, or any other metal; for prestigious private homes, public buildings, community spaces and for each kind of commission that requires a custom-made approach all, from the planning to installation. Assisting the customer during all the process, from the first steps to the finished work, Gonzato Contract is the ideal partner for any project, placing itself towards the client like the sole responsible of the quality of its product and its service.

Gonzato Contract è la divisione di Ind.i.a. che si occupa di forniture speciali, in ferro battuto, in acciaio inox o in qualsiasi altro metallo, per prestigiose proprietà private, edifici pubblici, alberghi, spazi comunitari e per ogni tipo di commissione che richieda un approccio custom made, dalla progettazione all'installazione. Affiancando il committente durante tutto il percorso, dai primi passi fino al lavoro finito, Gonzato Contract è partner ideale per ogni progetto e si pone nei confronti del cliente come unica responsabile della qualità del proprio prodotto e del servizio offerto.



## Production

From idea to installation, we take care of every aspect of the product.

Our items, compared to most of the products that are on the market, are manufactured in our production sites in Italy and Europe and are subject to quality tests that allow us to know the life of each piece, from its birth to its delivery.

In addition, we are the only company in the industry that can boast a production capacity can meet any special request within tight production times.

## Produzione

Dall'ideazione all'installazione, ci occupiamo di ogni aspetto del prodotto.

I nostri articoli, rispetto alla gran parte dei prodotti che si trovano sul mercato, sono realizzati nei nostri centri produttivi in Italia ed Europa, sottostando a test qualitativi che ci consentono di conoscere la vita di ogni pezzo, dalla sua nascita alla sua consegna.

Inoltre, siamo l'unica azienda del settore che può vantare una capacità produttiva in grado di soddisfare ogni richiesta speciale entro tempi di stretta produzione.





## Ordered, delivered!

With our branches, spread across all continents, we have the largest stock of articles in the sector in the world and, thanks to our agreements with major global couriers, we guarantee fast deliveries to any country. Furthermore, thanks to our portal Ind.i.a. Web, customers can stay up to date on the stock and on the details of their orders.

## Ordinato, consegnato!

Con le nostre filiali sparse in tutti i continenti, disponiamo del più grande stock mondiale di articoli del settore e, grazie ai nostri accordi con i più importanti spedizionieri, possiamo garantire consegne celeri in qualsiasi paese. Inoltre, grazie al nostro portale Ind.i.a. web, i clienti possono rimanere aggiornati sulle scorte di magazzino e sui dettagli dei propri ordini.

## Best price

The large quantities we treat, allow us scale economies on the raw material. In addition, the price of our pricelists is the price of manufacturer, not subject to recharges due to the presence of intermediaries. It is a factory price!

## Miglior prezzo

Le grosse quantità che trattiamo ci consentono economie di scala sulla materia prima. Inoltre, il prezzo dei nostri listini, è il prezzo del produttore, non soggetto a ricariche dovute alla presenza di intermediari. È un prezzo di fabbrica!

## Custom design

Our technicians are available for specialized advice and are able to develop customized projects. With our division Gonzato Contract we can also provide turnkey solutions, from design to installation.

## Progettazione su misura

I nostri tecnici sono a disposizione per consulenze specializzate e sono in grado di sviluppare progetti su misura. Con la nostra divisione Gonzato Contract possiamo fornire anche soluzioni chiavi in mano, dalla progettazione all'installazione.

## Products for installation, finishing and maintenance

In addition to our products, we also provide products and tools for their installation, finishing and maintenance: tools for assembly and treatment, paints and coatings to finish and embellish, cleaning products to maintain the beauty of the installation unchanged in time.

## Prodotti per l'installazione, finitura e manutenzione

Oltre ai nostri articoli, forniamo anche i prodotti e gli strumenti per la loro installazione, finitura e manutenzione: attrezzi per il montaggio e il trattamento, vernici e patine per rifinire ed impreziosire, prodotti per la pulizia per mantenere la bellezza dell'installazione invariata nel tempo.



## Innovation

The customer and his needs are the focus of our attention. For this reason, a team of designers and engineers works daily to conceive new products that meet the growing need for beauty in harmony with the technical requirements existing at present.

We are constantly looking at different materials to be combine to our lines to enhance the structural and aesthetic (wood, glass and many others).

We study the design of our products so that they can be ahead of the times. We believe that products should be easy to assemble and integrate with other architectural elements in order to adapt to the environment in which they are installed with maximum flexibility.

## Innovazione

Il cliente e le sue esigenze sono il fulcro della nostra attenzione. Per questo motivo un team di designers ed ingegneri lavora quotidianamente all'ideazione di nuovi prodotti che soddisfino sempre più la necessità di bellezza in armonia con le esigenze tecniche oggi esistenti.

Siamo costantemente alla ricerca di materiali diversi da accompagnare alle nostre linee per esaltarne le caratteristiche strutturali ed estetiche (legno, vetro e molti altri ancora).

Studiamo il design dei nostri prodotti in modo che possano essere al passo con i tempi. Crediamo che i prodotti debbano essere semplici da assemblare e da integrare con gli altri elementi architettonici in modo da potersi adattare all'ambiente in cui vengono installati con la massima flessibilità.



More value  
to your purchase  
Maggior valore  
al tuo acquisto



**Guaranteed, certified and patented quality**

Our articles are produced in our production centers in Italy and in Europe. We can manage the entire production chain ensuring the best final quality. This quality has long been recognized by the certifications obtained ISO 9001 and ISO 14011. A further added value, always as guarantee of originality and quality, it is represented by the patents obtained for many of our items, with the aim to protect both the inventiveness of our designer and the trust of our customers.

**Qualità garantita, certificata e brevettata**

I nostri articoli vengono realizzati nei nostri centri produttivi in Italia e in Europa. Possiamo quindi gestire tutta la catena di produzione garantendo così la migliore qualità finale. Tale qualità è da anni riconosciuta anche dalle certificazioni ottenute ISO 9001 e ISO 14011. Un ulteriore valore aggiunto, sempre a garanzia di originalità e qualità, è rappresentato dai brevetti registrati per molti dei nostri articoli, con lo scopo di tutelare sia l'ingegno dei nostri designer sia la fiducia dei nostri clienti.



**An excellence customer service**

Our back-office staff is fluent in five languages and is on hand to give you all the information and support you need.

**Un servizio clienti d'eccellenza**

Il nostro staff di back office parla fluentemente cinque lingue diverse ed è a vostra disposizione per darvi tutte le informazioni ed il supporto che vi servono.



**A marketing department at your disposal**

Our marketing department is on hand to organize activities and to develop promotional materials personalized with the customer's logo. For years now we make flyers and catalogs tailored to our loyal customers.

**Un ufficio marketing a tua disposizione**

Il nostro ufficio marketing è a disposizione per organizzare attività ed elaborare materiale promozionale personalizzato con il logo del cliente. Da anni ormai realizziamo volantini e cataloghi ad hoc per i nostri clienti più affezionati.



**Educational**

With our specialized staff, we organize meetings of technical training: all you need to know to design and install parapets, railings, stairs and other structural elements in accordance with law.

**Formazione**

Con il nostro personale specializzato, organizziamo incontri di formazione tecnica: tutto ciò che bisogna sapere per progettare ed installare parapetti, cancellate, scale ed altri elementi strutturali a norma di legge.





LONG BARS

BARRE LUNGHE

Arteferro long bars are variously shaped metal bars, used for a multitude of applications: along a staircase or wall where a support is needed, or as a structural part of a gate or fence. Using both hot and cold processes, they are available in lengths of 3 and 6 metres, with square, rectangular or round sections. To complete the section, there's a wide range of fittings, joints and clamps for tightening of decorative elements.

Le barre lunghe Arteferro sono barre di metallo variamente sagomate, si usano in una moltitudine di applicazioni: lungo una scala od una parete in cui sia necessario un appoggio, come parte strutturale di un cancello o di una recinzione. Con lavorazioni sia a caldo che a freddo sono disponibili nelle lunghezze da 3 e 6 metri, con sezioni quadre, rettangolari o tonde. A completare il capitolo, la vasta gamma di partenze, giunzioni e fascette per il serraggio di elementi decorativi.

## Long Bars - Barre lunghe

A Plain bars	Barre lisce .....	pag.17
B Decorative round bars	Tondi lavorati .....	pag.19
C Decorative square bars	Quadri lavorati .....	pag.20
D Decorative flat bars	Piatti lavorati.....	pag.22
E Hammered edges tubes	Tubi lavorati.....	pag.24
F Handrails and end pieces	Corrimani e Partenze.....	pag.26
G Twisted pickets	Torciglioni .....	pag.36
H Collars	Fascette .....	pag.38

**Choose the section!  
Identifying the finish is  
very easy**

**Parti dalla sezione!  
individuare la finitura  
sarà un gioco da ragazzi**

**i**

Not all of the Arterferro items are available in **Arterferro Quick**, just a special selection. Find out about the entire range in the catalogue

In **Arterferro Quick** non sono presenti tutti gli articoli Arterferro, ma solo una speciale selezione. Scopri la gamma completa nel catalogo

*Compendium*





Choose the item, add "Z" to order the galvanized version

Scegli l'articolo, aggiungi "Z" per ordinare la versione zincata a freddo



7000 t

of bars and handrails manufactured each month in our forges

di barre e corrimani vengono forgiate ogni mese nelle nostre fucine

Example - Esempio

**1368/23/6000/Z** = galvanized version  
= versione zincata a freddo

HOT ROLLED ROUND AND SQUARE PLAIN BARS  
TONDI E QUADRI LISCI LAMINATI A CALDO



Section Sezione	Length Lunghezza	Mech. hammering Lav. meccanica	Plain Liscio
			Art.
Ø 6 mm	3000 mm		1368/6
	6000 mm		1368/6/6000
Ø 7 mm	3000 mm		-
	6000 mm		-
Ø 8 mm	3000 mm		1368/7
	6000 mm		1368/7/6000
Ø 10 mm	3000 mm		1368/8
	6000 mm		1368/8/6000
Ø 12 mm	3000 mm		1368/9
	6000 mm		1368/9/6000
Ø 14 mm	3000 mm		1368/10
	6000 mm		1368/10/6000
Ø 16 mm	3000 mm		1368/23
	6000 mm		1368/23/6000
Ø 18 mm	3000 mm		1368/24
	6000 mm		1368/24/6000
Ø 20 mm	3000 mm		1368/25
	6000 mm		1368/25/6000
Ø 22 mm	3000 mm		1368/32
	6000 mm		1368/32/6000
Ø 24 mm	3000 mm		1368/33
	6000 mm		1368/33/6000
Ø 25 mm	3000 mm		1368/25/S
	6000 mm		1368/25/S/6000
Ø 26 mm	3000 mm		1368/34
	6000 mm		1368/34/6000
Ø 30 mm	3000 mm		1368/35
	6000 mm		1368/35/6000
Ø 35 mm	3000 mm		-
	6000 mm		-
Ø 40 mm	3000 mm		-
	6000 mm		-
Ø 50 mm	3000 mm		-
	6000 mm		-

Section Sezione	Mech. hammering Lav. meccanica	Plain Liscio
		Art.
6 x 6 mm		1368/1
		1368/1/6000
7 x 7 mm		1368/27
		1368/27/6000
8 x 8 mm		1368/2
		1368/2/6000
10 x 10 mm		1368/3
		1368/3/6000
12 x 12 mm		1368/4
		1368/4/6000
14 x 14 mm		1368/5
		1368/5/6000
16 x 16 mm		1368/20
		1368/20/6000
18 x 18 mm		1368/21
		1368/21/6000
20 x 20 mm		1368/22
		1368/22/6000
22 x 22 mm		1368/28
		1368/28/6000
24 x 24 mm		-
		-
25 x 25 mm		1368/26
		1368/26/6000
26 x 26 mm		-
		-
30 x 30 mm		1368/22/S
		1368/22/S/6000
35 x 35 mm		1368/29
		1368/29/6000
40 x 40 mm		1368/30
		1368/30/6000
50 x 50 mm		1368/31
		1368/31/6000



## Plain bars - Barre lisce

## HOT ROLLED FLAT BARS - PIATTI LAMINATI A CALDO

NEW



Section Sezione	Length Lunghezza Art.	Mech. hammering Lav. meccanica
		Plain Liscio Art.
10 x 5 mm	3000 mm	1368/11
	6000 mm	1368/11/6000
12 x 4 mm	3000 mm	1368/37
	6000 mm	1368/37/6000
12 x 5 mm	3000 mm	1368/38
	6000 mm	1368/38/6000
12 x 6 mm	3000 mm	1368/12
	6000 mm	1368/12/6000
12 x 8 mm	3000 mm	1368/39
	6000 mm	1368/39/6000
14 x 4 mm	3000 mm	1368/40
	6000 mm	1368/40/6000
14 x 6 mm	3000 mm	1368/41
	6000 mm	1368/41/6000
14 x 8 mm	3000 mm	1368/13
	6000 mm	1368/13/6000
16 x 4 mm	3000 mm	1368/14
	6000 mm	1368/14/6000
16 x 5 mm	3000 mm	1368/42
	6000 mm	1368/42/6000
16 x 6 mm	3000 mm	1368/43
	6000 mm	1368/43/6000
16 x 8 mm	3000 mm	1368/44
	6000 mm	1368/44/6000
16 x 10 mm	3000 mm	1368/45
	6000 mm	1368/45/6000
20 x 3 mm	3000 mm	1368/46
	6000 mm	1368/46/6000
20 x 4 mm	3000 mm	1368/15
	6000 mm	1368/15/6000
20 x 5 mm	3000 mm	1368/47
	6000 mm	1368/47/6000
20 x 6 mm	3000 mm	1368/16
	6000 mm	1368/16/6000
20 x 8 mm	3000 mm	1368/48
	6000 mm	1368/48/6000
20 x 10 mm	3000 mm	1368/49
	6000 mm	1368/49/6000
20 x 15 mm	3000 mm	1368/50
	6000 mm	1368/50/6000
25 x 3 mm	3000 mm	1368/51
	6000 mm	1368/51/6000
25 x 4 mm	3000 mm	1368/17
	6000 mm	1368/17/6000
25 x 5 mm	3000 mm	1368/52
	6000 mm	1368/52/6000
25 x 6 mm	3000 mm	1368/53
	6000 mm	1368/53/6000
25 x 8 mm	3000 mm	1368/54
	6000 mm	1368/54/6000
25 x 10 mm	3000 mm	1368/55
	6000 mm	1368/55/6000
30 x 5 mm	3000 mm	1368/57
	6000 mm	1368/57/6000
30 x 6 mm	3000 mm	1368/58
	6000 mm	1368/58/6000
30 x 8 mm	3000 mm	1368/18
	6000 mm	1368/18/6000
30 x 10 mm	3000 mm	1368/59
	6000 mm	1368/59/6000
30 x 12 mm	3000 mm	1368/60
	6000 mm	1368/60/6000

NEW



Section Sezione	Length Lunghezza Art.	Mech. hammering Lav. meccanica
		Plain Liscio Art.
30 x 15 mm	3000 mm	1368/61
	6000 mm	1368/61/6000
30 x 20 mm	3000 mm	1368/62
	6000 mm	1368/62/6000
35 x 4 mm	3000 mm	1368/63
	6000 mm	1368/63/6000
35 x 5 mm	3000 mm	1368/64
	6000 mm	1368/64/6000
35 x 6 mm	3000 mm	1368/65
	6000 mm	1368/65/6000
35 x 8 mm	3000 mm	1368/66
	6000 mm	1368/66/6000
35 x 10 mm	3000 mm	1368/67
	6000 mm	1368/67/6000
35 x 12 mm	3000 mm	1368/68
	6000 mm	1368/68/6000
35 x 15 mm	3000 mm	1368/69
	6000 mm	1368/69/6000
40 x 4 mm	3000 mm	1368/70
	6000 mm	1368/70/6000
40 x 5 mm	3000 mm	1368/71
	6000 mm	1368/71/6000
40 x 6 mm	3000 mm	1368/72
	6000 mm	1368/72/6000
40 x 8 mm	3000 mm	1368/19
	6000 mm	1368/19/6000
40 x 10 mm	3000 mm	1368/73
	6000 mm	1368/73/6000
40 x 12 mm	3000 mm	1368/74
	6000 mm	1368/74/6000
40 x 15 mm	3000 mm	1368/75
	6000 mm	1368/75/6000
40 x 20 mm	3000 mm	1368/76
	6000 mm	1368/76/6000
45 x 6 mm	3000 mm	1368/77
	6000 mm	1368/77/6000
45 x 8 mm	3000 mm	1368/78
	6000 mm	1368/78/6000
45 x 10 mm	3000 mm	1368/79
	6000 mm	1368/79/6000
45 x 12 mm	3000 mm	1368/80
	6000 mm	1368/80/6000
45 x 20 mm	3000 mm	1368/81
	6000 mm	1368/81/6000
50 x 3 mm	3000 mm	1368/82
	6000 mm	1368/82/6000
50 x 4 mm	3000 mm	1368/83
	6000 mm	1368/83/6000
50 x 6 mm	3000 mm	1368/84
	6000 mm	1368/84/6000
50 x 8 mm	3000 mm	1368/85
	6000 mm	1368/85/6000
50 x 10 mm	3000 mm	1368/86
	6000 mm	1368/86/6000
50 x 12 mm	3000 mm	1368/87
	6000 mm	1368/87/6000
50 x 20 mm	3000 mm	1368/88
	6000 mm	1368/88/6000
50 x 25 mm	3000 mm	1368/89
	6000 mm	1368/89/6000
60 x 4 mm	3000 mm	1368/90
	6000 mm	1368/90/6000

NEW



Section Sezione	Length Lunghezza Art.	Mech. hammering Lav. meccanica
		Plain Liscio Art.
60 x 6 mm	3000 mm	1368/91
	6000 mm	1368/91/6000
60 x 8 mm	3000 mm	1368/92
	6000 mm	1368/92/6000
60 x 10 mm	3000 mm	1368/93
	6000 mm	1368/93/6000
60 x 12 mm	3000 mm	1368/94
	6000 mm	1368/94/6000
60 x 20 mm	3000 mm	1368/95
	6000 mm	1368/95/6000
70 x 5 mm	3000 mm	1368/96
	6000 mm	1368/96/6000
70 x 6 mm	3000 mm	1368/97
	6000 mm	1368/97/6000
70 x 8 mm	3000 mm	1368/98
	6000 mm	1368/98/6000
80 x 8 mm	3000 mm	1368/99
	6000 mm	1368/99/6000
90 x 4 mm	3000 mm	1368/100
	6000 mm	1368/100/6000
90 x 5 mm	3000 mm	1368/101
	6000 mm	1368/101/6000
100 x 8 mm	3000 mm	1368/102
	6000 mm	1368/102/6000
120 x 8 mm	3000 mm	1368/103
	6000 mm	1368/103/6000



COLD PROCESSED - LAVORATI A FREDDO

Decorative round bars - Tondi lavorati



Section Sezione	Length Lunghezza	Mech. hammering Lav. meccanica Grapevine effect Tralcio vite Art.	Mech. hammering Lav. meccanica Bark effect Corteccia Art.	Power hammering Lav. manuale Power long hammering Magliatura piatta allungata Art.	Power hammering Lav. manuale Power hammered Magliato Art.	Power hammering Lav. manuale Hammered Battuto Art.
6 mm	3000 mm	-	-	-	-	600/1
	6000 mm	-	-	-	-	-
8 mm	3000 mm	598/11	599/1	-	598/10	600/2
	6000 mm	598/11/6000	-	-	-	-
10 mm	3000 mm	598/12	599/2	-	-	600/3
	6000 mm	-	599/2/6000	-	-	600/3/6000
12 mm	3000 mm	598/13	599/3	598/1	-	600/4
	6000 mm	598/13/6000	599/3/6000	-	-	600/4/6000
14 mm	3000 mm	598/14	599/4	598/2	118/A/10	600/5
	6000 mm	-	599/4/6000	-	-	600/5/6000
16 mm	3000 mm	598/15	599/5	598/3	118/A/11	600/6
	6000 mm	-	599/5/6000	-	-	600/6/6000
18 mm	3000 mm	598/16	599/6	598/4	118/A/12	600/7
	6000 mm	-	599/6/6000	-	-	600/7/6000
20 mm	3000 mm	-	599/7	598/5	118/A/13	600/8
	6000 mm	-	599/7/6000	-	-	600/8/6000
22 mm	3000 mm	598/18	599/8	-	-	600/9
	6000 mm	-	599/8/6000	-	-	600/9/6000
24 mm	3000 mm	-	599/9	-	-	600/10
	6000 mm	-	599/9/6000	-	-	600/10/6000
25 mm	3000 mm	-	-	598/6	118/A/14	-
	6000 mm	-	-	-	-	-
26 mm	3000 mm	-	-	-	-	-
	6000 mm	-	-	-	-	-
30 mm	3000 mm	-	-	598/7	118/A/15	-
	6000 mm	-	-	-	-	-
40 mm	3000 mm	-	-	598/8	118/A/16	-
	6000 mm	-	-	-	-	-





Section Sezione	Length Lunghezza	Mech. hammering Lav. meccanica Hammered 4 edges Battuto 4 spigoli	Mech. hammering Lav. meccanica Hammered 4 sides and 4 edges Battuto 4 lati e 4 spigoli	Mech. hammering Lav. meccanica Hammered 4 sides Battuto 4 lati	Mech. hammering Lav. meccanica Hammered 4 sides Battuto 4 lati	Mech. hammering Lav. meccanica Flat beveled 4 edges Smuss. piana 4 spigoli	Mech. hammering Lav. meccanica Hammered 4 sides Magliatura 4 lati	Mech. hammering Lav. meccanica Diamond 2 sides Diamantato 2 lati
		Art.	Art.	Art.	Art.	Art.	Art.	Art.
6 x 6 mm	3000 mm	-	-	-	-	-	-	-
	6000 mm	-	-	-	-	-	-	-
7 x 7 mm	3000 mm	-	-	-	-	-	-	-
	6000 mm	-	-	-	-	-	-	-
8 x 8 mm	3000 mm	-	-	-	-	-	-	-
	6000 mm	-	-	-	-	-	-	-
10 x 10 mm	3000 mm	-	-	-	-	-	-	-
	6000 mm	118/1/Q10/6000	-	-	-	-	-	-
12 x 12 mm	3000 mm	118/1	118/A/1	1841/1	1841/30	GD124/17	1370/15	1370/13
	6000 mm	118/1/6000	118/A/1/6000	-	-	GD124/25	1370/15/6000	1370/13/6000
14 x 14 mm	3000 mm	118/2	118/A/2	1841/2	1841/31	GD124/18	1370/16	1370/14
	6000 mm	118/2/6000	118/A/2/6000	-	-	GD124/26	1370/16/6000	1370/14/6000
15 x 15 mm	3000 mm	-	-	-	-	-	-	-
	6000 mm	-	-	-	-	-	-	-
16 x 16 mm	3000 mm	118/3	118/A/3	1841/3	1841/32	GD124/19	1370/17	-
	6000 mm	118/3/6000	118/A/3/6000	-	-	GD124/27	1370/17/6000	-
17 x 17 mm	3000 mm	-	-	-	-	-	-	-
	6000 mm	-	-	-	-	-	-	-
18 x 18 mm	3000 mm	118/4	118/A/4	1841/4	1841/33	GD124/20	1370/18	-
	6000 mm	118/4/6000	118/A/4/6000	-	-	GD124/28	1370/18/6000	-
20 x 20 mm	3000 mm	118/5	118/A/5	1841/5	1841/34	GD124/21	1370/19	-
	6000 mm	118/5/6000	118/A/5/6000	-	-	GD124/29	1370/19/6000	-
21 x 21 mm	3000 mm	-	-	-	-	-	-	-
	6000 mm	-	-	-	-	-	-	-
22 x 22 mm	3000 mm	-	-	1841/6	1841/35	GD124/22	1370/20	-
	6000 mm	-	-	-	-	GD124/30	1370/20/6000	-
23 x 23 mm	3000 mm	-	-	-	-	-	-	-
	6000 mm	-	-	-	-	-	-	-
24 x 24 mm	3000 mm	-	-	-	-	-	-	-
	6000 mm	-	-	-	-	-	-	-
25 x 25 mm	3000 mm	118/6	180/53	1841/7	1841/36	GD124/23	1370/21	-
	6000 mm	118/6/6000	180/53/6000	-	-	GD124/31	1370/21/6000	-
26 x 26 mm	3000 mm	-	-	-	-	-	-	-
	6000 mm	-	-	-	-	-	-	-
27 x 27 mm	3000 mm	-	-	-	-	-	-	-
	6000 mm	-	-	-	-	-	-	-
30 x 30 mm	3000 mm	118/24	180/50	-	-	GD124/24	1370/22	-
	6000 mm	118/24/6000	180/50/6000	-	-	GD124/32	1370/22/6000	-
35 x 35 mm	3000 mm	118/24/S	-	-	-	-	1370/23	-
	6000 mm	118/24/6000/S	-	-	-	-	1370/23/6000	-
40 x 40 mm	3000 mm	118/25	180/54	-	-	-	1370/24	-
	6000 mm	118/25/6000	180/54/6000	-	-	-	1370/24/6000	-
50 x 50 mm	3000 mm	-	-	-	-	-	1370/25	-
	6000 mm	-	-	-	-	-	1370/25/6000	-



## COLD PROCESSED - LAVORATI A FREDDO

## Decorative square bars - Quadri lavorati



Section Sezione	Length Lunghezza	Mech. hammering Lav. meccanica Hammered 4 sides Martellato 4 lati Art.	Mech. hammering Lav. meccanica Bark effect 4 sides Corteccia 4 lati Art.	Mech. hammering Lav. meccanica Four-leaf clover Quadrifoglio Art.	Mech. hammering Lav. meccanica Grooved 4 sides Rigato 4 lati Art.	Mech. hammering Lav. meccanica Grooved and hamm. 4 sides Rigato e spigolato 4 lati Art.	Mech. hammering Lav. meccanica Multiline 4 sides Multiriga 4 lati Art.	Mech. hammering Lav. meccanica Irregular beveled 4 corners Smuss. irregolare 4 angoli Art.
6 x 6 mm	3000 mm	118/15/Q/6	-	-	-	-	-	-
	6000 mm	-	-	-	-	-	-	-
7 x 7 mm	3000 mm	118/15/S	-	-	-	-	-	-
	6000 mm	-	-	-	-	-	-	-
8 x 8 mm	3000 mm	118/15	-	-	625/1	-	-	-
	6000 mm	118/15/6000	-	-	-	-	-	-
10 x 10 mm	3000 mm	118/16	623/4	626/10	625/2	-	-	-
	6000 mm	118/16/6000	623/4/6000	626/10/6000	-	-	-	-
12 x 12 mm	3000 mm	118/17	623/5	-	625/3	625/8	-	-
	6000 mm	118/17/6000	623/5/6000	-	-	-	-	-
14 x 14 mm	3000 mm	118/18	623/6	626/12	625/4	-	-	-
	6000 mm	118/18/6000	623/6/6000	626/12/6000	-	-	-	-
15 x 15 mm	3000 mm	-	-	626/13	-	-	-	-
	6000 mm	-	-	626/13/6000	-	-	-	-
16 x 16 mm	3000 mm	118/19	623/7	-	625/5	625/9	-	-
	6000 mm	118/19/6000	623/7/6000	-	-	-	-	-
17 x 17 mm	3000 mm	-	-	626/14	-	-	-	-
	6000 mm	-	-	626/14/6000	-	-	-	-
18 x 18 mm	3000 mm	118/20	623/8	626/15	625/6	-	-	-
	6000 mm	118/20/6000	623/8/6000	626/15/6000	-	-	-	-
20 x 20 mm	3000 mm	118/21	623/9	-	625/7	-	-	-
	6000 mm	118/21/6000	623/9/6000	-	-	-	-	-
21 x 21 mm	3000 mm	-	-	-	-	-	-	-
	6000 mm	-	-	-	-	-	-	-
22 x 22 mm	3000 mm	-	-	-	-	-	-	-
	6000 mm	-	-	-	-	-	-	-
23 x 23 mm	3000 mm	-	-	626/16	-	-	-	-
	6000 mm	-	-	626/16/6000	-	-	-	-
24 x 24 mm	3000 mm	-	623/11	-	-	-	-	-
	6000 mm	-	623/11/6000	-	-	-	-	-
25 x 25 mm	3000 mm	118/22	-	-	-	-	-	GD124/36
	6000 mm	118/22/6000	-	-	-	-	-	GD124/33
26 x 26 mm	3000 mm	-	-	-	-	-	-	-
	6000 mm	-	-	-	-	-	-	-
27 x 27 mm	3000 mm	-	-	-	-	-	-	-
	6000 mm	-	-	-	-	-	-	-
30 x 30 mm	3000 mm	118/23	-	-	1806/3	-	1806/9	-
	6000 mm	118/23/6000	-	-	1806/6	-	1806/12	-
35 x 35 mm	3000 mm	-	-	-	-	-	-	-
	6000 mm	-	-	-	-	-	-	-
40 x 40 mm	3000 mm	118/23/S	-	-	1806/2	-	1806/8	GD124/37
	6000 mm	-	-	-	1806/5	-	1806/11	GD124/34
50 x 50 mm	3000 mm	-	-	-	1806/1	-	1806/7	GD124/38
	6000 mm	-	-	-	1806/4	-	1806/10	GD124/35



Items  
GD124/33, 34  
and 35 were used  
to create  
the new features  
of the Colosseum in Rome.

Gli articoli GD124/33, 34  
e 35 sono stati utilizzati  
per la realizzazione  
delle nuove cancellate  
del Colosseo a Roma.



Arteferro  
products  
can be manufactured  
as well as customised.

I prodotti Arteferro  
sono realizzabili  
anche su misura.



Section Sezione	Length Lunghezza	Mech. hammering Lav. meccanica	Mech. hammering Lav. meccanica	Mech. hammering Lav. meccanica	Mech. hammering Lav. meccanica	Mech. hammering Lav. meccanica
		Hammered 2 edges Spigolato 2 spigoli	Hammered 4 edges Spigolato 4 spigoli	Diamond 2 small sides Diamantato 2 lati piccoli	Grooved 2 small sides Rigato 2 lati piccoli	Notched 2 small sides Tachettato 2 lati piccoli
		Art.	Art.	Art.	Art.	Art.
∅ 12 x 6 mm	3000 mm	-	1839/21	623/1	1369/1/S	622/1
	6000 mm	-	1839/21/6000	623/1/6000	1369/1/S/6000	622/1/6000
∅ 14 x 6 mm	3000 mm	-	1839/22	623/3	1369/1/S1	622/6
	6000 mm	-	1839/22/6000	623/3/6000	1369/1/S1/6000	622/6/6000
∅ 14 x 8 mm	3000 mm	-	1839/23	623/12	1369/1	622/3
	6000 mm	-	1839/23/6000	623/12/6000	1369/1/6000	622/3/6000
∅ 16 x 6 mm	3000 mm	-	1839/26	623/2	1369/1/S2	622/4
	6000 mm	-	1839/26/6000	623/2/6000	1369/1/S2/6000	622/4/6000
∅ 16 x 8 mm	3000 mm	-	1839/24	623/13	1369/2	622/5
	6000 mm	-	1839/24/6000	623/13/6000	1369/2/6000	622/5/6000
∅ 20 x 6 mm	3000 mm	-	-	623/2/S	-	622/4/S
	6000 mm	118/7/20X6/6000	1839/15/S/L6	-	-	622/4/S/6000
∅ 20 x 8 mm	3000 mm	118/7	118/7/S1	-	-	622/5/S1
	6000 mm	118/7/6000	118/7/S1/6000	-	-	-
∅ 20 x 10 mm	3000 mm	-	118/7/S	-	-	-
	6000 mm	-	118/7/S/6000	-	-	-
∅ 25 x 5 mm	3000 mm	-	-	-	-	-
	6000 mm	1838/5/S/6000	-	-	-	-
∅ 25 x 6 mm	3000 mm	1838/5	1839/15	-	-	-
	6000 mm	1838/5/6000	1839/15/6000	-	-	-
∅ 25 x 8 mm	3000 mm	118/8	1839/16	-	-	622/5/S2
	6000 mm	118/8/6000	1839/16/6000	-	-	-
∅ 25 x 10 mm	3000 mm	1838/6	118/8/S1	-	-	-
	6000 mm	1838/6/6000	118/8/S1/6000	-	-	-
∅ 30 x 6 mm	3000 mm	1838/7	1839/17	-	-	-
	6000 mm	1838/7/6000	1839/17/6000	-	-	-
∅ 30 x 8 mm	3000 mm	114/9	1839/18	-	-	622/5/S
	6000 mm	114/9/6000	1839/18/6000	-	-	-
∅ 30 x 10 mm	3000 mm	114/9/S2	118/9/S1	-	-	-
	6000 mm	118/9/S/6000	118/9/S1/6000	-	-	-
∅ 30 x 12 mm	3000 mm	-	1839/18/S	-	-	-
	6000 mm	-	1839/18/S6000	-	-	-
∅ 30 x 15 mm	3000 mm	-	1839/1	-	-	-
	6000 mm	-	1839/1/6000	-	-	-
∅ 30 x 20 mm	3000 mm	-	1839/2	-	-	-
	6000 mm	-	1839/2/6000	-	-	-
∅ 35 x 8 mm	3000 mm	114/9/35X8	1839/18/S1	-	-	-
	6000 mm	114/9/35X8/6000	1839/18/S2	-	-	-
∅ 35 x 10 mm	3000 mm	-	1839/18/S3	-	-	-
	6000 mm	-	1839/18/S4	-	-	-
∅ 35 x 15 mm	3000 mm	-	1839/1/S	-	-	-
	6000 mm	-	1839/1/S/6000	-	-	-
∅ 40 x 6 mm	3000 mm	1838/2/S/3000	1839/19	-	-	-
	6000 mm	1838/2/S/6000	1839/19/6000	-	-	-
∅ 40 x 8 mm	3000 mm	1838/2	1839/20	-	-	-
	6000 mm	1838/2/6000	1839/20/6000	-	-	-
∅ 40 x 10 mm	3000 mm	1838/2/S1	1839/20/S3	-	-	-
	6000 mm	1838/2/S1/6000	1839/20/S3/6000	-	-	-
∅ 40 x 15 mm	3000 mm	-	1839/3	-	-	-
	6000 mm	-	1839/3/6000	-	-	-
∅ 40 x 20 mm	3000 mm	-	1839/4	-	-	-
	6000 mm	-	1839/4/6000	-	-	-
∅ 50 x 6 mm	3000 mm	1838/3/S7	1839/19/50X6	-	-	-
	6000 mm	1838/3/S6	1839/19/S1	-	-	-
∅ 50 x 8 mm	3000 mm	1838/3	1838/3/S1	-	-	-
	6000 mm	1838/3/6000	1838/3/S2	-	-	-
∅ 50 x 10 mm	3000 mm	1838/3/S5	1839/20/S4	-	-	-
	6000 mm	1838/3/S4	1839/20/S6000	-	-	-
∅ 60 x 6 mm	3000 mm	1838/4/S1	1839/19/60X6	-	-	-
	6000 mm	1838/4/S1/L6	1839/19/S	-	-	-
∅ 60 x 8 mm	3000 mm	1838/4	1839/20/S1	-	-	-
	6000 mm	1838/4/6000	1839/20/S2	-	-	-



## COLD PROCESSED - LAVORATI A FREDDO

## Decorative flat bars - Piatti lavorati



Section Sezione	Length Lunghezza	Mech. hammering Lav. meccanica	Mech. hammering Lav. meccanica	Mech. hammering Lav. meccanica	Mech. hammering Lav. meccanica	Mech. hammering Lav. meccanica
		Hammered 2 wide sides Martellato 2 lati larghi	Hamm. 2 sides and 4 edges Battuto 2 lati e 4 spigoli	Hammered 2 sides Battuto 2 lati	Hammered 2 sides and 4 edges Martellato 2 lati e 4 spigoli	Hammered 1 side and 2 edges Battuto 1 lato e 2 spigoli
		Art.	Art.	Art.	Art.	Art.
∅ 12 x 6 mm	3000 mm	-	-	-	-	-
	6000 mm	-	-	-	-	-
∅ 14 x 6 mm	3000 mm	118/10/S1	-	-	-	-
	6000 mm	-	-	-	-	-
∅ 14 x 8 mm	3000 mm	-	-	-	-	-
	6000 mm	-	-	-	-	-
∅ 16 x 4 mm	3000 mm	118/10	-	-	-	-
	6000 mm	-	-	-	-	-
∅ 16 x 6 mm	3000 mm	-	-	-	-	-
	6000 mm	-	-	-	-	-
∅ 16 x 8 mm	3000 mm	-	-	-	-	-
	6000 mm	-	-	-	-	-
∅ 20 x 4 mm	3000 mm	118/11	-	-	-	-
	6000 mm	118/11/6000	-	-	-	-
∅ 20 x 6 mm	3000 mm	118/12	-	-	-	-
	6000 mm	118/12/6000	-	-	-	-
∅ 20 x 8 mm	3000 mm	118/26	118/A/6/20X8	-	-	-
	6000 mm	-	118/A/6/20X8/6000	-	-	-
∅ 25 x 4 mm	3000 mm	118/27	-	-	-	-
	6000 mm	-	-	-	-	-
∅ 25 x 5 mm	3000 mm	118/27/S	-	-	-	-
	6000 mm	118/27/S/6000	-	-	-	-
∅ 25 x 8 mm	3000 mm	118/28	-	-	-	-
	6000 mm	-	-	-	-	-
∅ 25 x 5 mm	3000 mm	118/13/S	-	-	-	-
	6000 mm	118/13/S/6000	-	-	-	-
∅ 30 x 6 mm	3000 mm	-	118/A/6/SS	1839/7	1839/11	-
	6000 mm	-	118/A/6/S/L6	1839/7/6000	1839/11/6000	-
∅ 30 x 8 mm	3000 mm	118/13	118/A/6	1839/8	1839/12	-
	6000 mm	118/13/6000	118/A/6/6000	1839/8/6000	1839/12/6000	-
∅ 30 x 10 mm	3000 mm	-	118/A/7	-	-	-
	6000 mm	-	118/A/7/6000	-	-	-
∅ 30 x 15 mm	3000 mm	118/13/S1	118/A/8	-	-	-
	6000 mm	-	118/A/8/6000	-	-	-
∅ 30 x 20 mm	3000 mm	180/51	118/A/9	-	-	-
	6000 mm	-	118/A/9/6000	-	-	-
∅ 40 x 4 mm	3000 mm	118/29	-	-	-	-
	6000 mm	118/29/6000	-	-	-	-
∅ 40 x 6 mm	3000 mm	-	-	1839/9	1839/13	1839/5
	6000 mm	-	-	1839/9/6000	1839/13/6000	1839/5/6000
∅ 40 x 8 mm	3000 mm	118/14	118/A/6/S	-	1839/14	1839/6
	6000 mm	118/14/6000	118/A/6/S/6000	-	1839/14/6000	1839/6/6000
∅ 40 x 10 mm	3000 mm	118/14/S2	-	1839/10	-	-
	6000 mm	118/14/S2/6000	-	1839/10/6000	-	-
∅ 40 x 15 mm	3000 mm	118/14/S3	-	-	-	-
	6000 mm	-	-	-	-	-
∅ 40 x 20 mm	3000 mm	-	118/A/9/S	-	-	-
	6000 mm	-	118/A/9/S/6000	-	-	-
∅ 50 x 4 mm	3000 mm	118/30	-	-	-	-
	6000 mm	-	-	-	-	-
∅ 50 x 8 mm	3000 mm	-	118/A/6/50X8	-	-	-
	6000 mm	-	118/A/6/50X8/6000	-	-	-
∅ 60 x 8 mm	3000 mm	-	-	-	1839/14/S	-
	6000 mm	-	-	-	-	-

**i** Choose the item, add "Z" to order the galvanized version

**i** Scegli l'articolo, aggiungi "Z" per ordinare la versione zincata a freddo

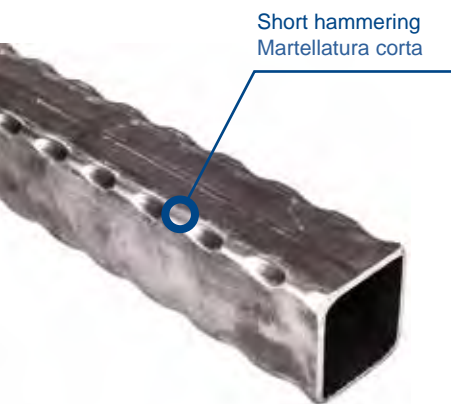
**SQUARE TUBES WITH SHORT HAMMERING ON EDGES**  
**TUBI QUADRATI CON MARTELLATURA CORTA SUGLI SPIGOLI**

Section Sezione	Thickness Spessore	L 3000 mm		L 6000 mm	
		Art.		Art.	
Φ 12 x 12 mm	1 mm	1374/21	1374/19		
Φ 12 x 12 mm	1,5 mm	1374/26	1374/27		
Φ 16 x 16 mm	1 mm	1374/22	1374/20		
Φ 16 x 16 mm	1,5 mm	1374/25	1374/24		
Φ 20 x 20 mm	2,5 mm	1374/1	118/E/1		
Φ 25 x 25 mm	2,5 mm	1374/2	118/E/9		
Φ 30 x 30 mm	2,5 mm	1374/3	118/E/3		
Φ 35 x 35 mm	2,5 mm	1374/23	118/E/18		
Φ 40 x 40 mm	2,5 mm	1374/4	118/E/5		
Φ 50 x 50 mm	2,5 mm	1374/5	1374/15		
Φ 60 x 60 mm	2,5 mm	-	118/E/13		
Φ 80 x 80 mm	2,7 mm	1374/6	1374/16		
Φ 100 x 100 mm	2,7 mm	1374/7	1374/17		
Φ 120 x 120 mm	2,7 mm	1374/8	1374/18		



Choose the item,  
add "Z" to order the  
galvanized version

Scegli l'articolo,  
aggiungi "Z" per ordinare  
la versione zincata a  
freddo

**RECTANGULAR TUBES WITH SHORT HAMMERING ON EDGES**  
**TUBI RETTANGOLARI CON MARTELLATURA CORTA SUGLI SPIGOLI**

Section Sezione	Thickness Spessore	L 3000 mm		L 6000 mm	
		Art.		Art.	
∅ 30 x 20 mm	2,5 mm	1374/9	118/E/2		
∅ 40 x 20 mm	2,5 mm	1374/10	118/E/4		
∅ 40 x 30 mm	2,5 mm	1374/10/S4	118/E/19		
∅ 50 x 30 mm	2,5 mm	1374/11	118/E/6		
∅ 50 x 40 mm	2,5 mm	1374/11/S5	118/E/14		
∅ 60 x 30 mm	2,5 mm	1374/12	118/E/7		
∅ 60 x 40 mm	2,5 mm	1374/29	118/E/15		
∅ 80 x 40 mm	2,7 mm	1374/13	118/E/8		
∅ 80 x 60 mm	2,7 mm	1374/13/S	118/E/8/S1		
∅ 100 x 40 mm	2,7 mm	1374/14	118/E/10		
∅ 100 x 50 mm	2,7 mm	1374/30	118/E/17		
∅ 120 x 40 mm	2,7 mm	-	118/E/12		

**SQUARE TUBES WITH LONG HAMMERING ON EDGES**  
**TUBI QUADRATI CON MARTELLATURA ALLUNGATA SUGLI SPIGOLI**

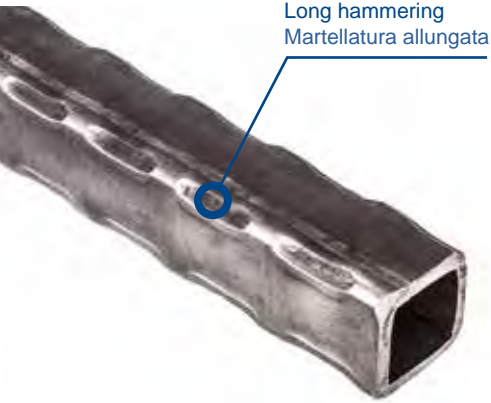
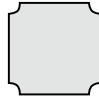

Long hammering  
Martellatura allungata

Section Sezione	Thickness Spessore	L 3000 mm	L 6000 mm
		Art.	Art.
□ 25 x 25 mm	2,5 mm	1374/2/S1	118/E/9/S1
□ 25 x 25 mm	2 mm	1374/2/S2	118/E/9/S2
□ 30 x 30 mm	2,5 mm	1374/3/S2	118/E/3/S4
□ 30 x 30 mm	2 mm	1374/3/S4	118/E/3/S5
□ 40 x 40 mm	2,5 mm	1374/4/S1	118/E/5/S3
□ 50 x 50 mm	2,5 mm	1374/5/S	1374/15/S2
□ 60 x 60 mm	2,5 mm	1374/12/S4	118/E/7/S5



**RECTANGULAR TUBES WITH LONG HAMMERING ON EDGES**  
**TUBI RETTANGOLARI CON MARTELLATURA ALLUNGATA SUGLI SPIGOLI**

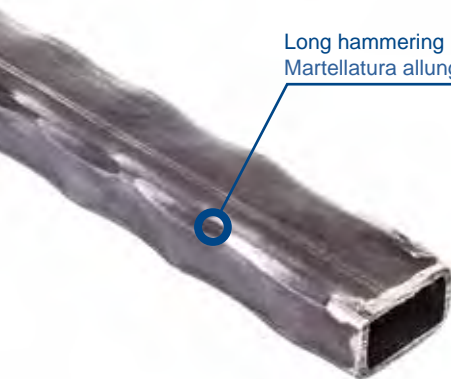

Long hammering  
Martellatura allungata

Section Sezione	Thickness Spessore	L 3000 mm	L 6000 mm
		Art.	Art.
▧ 30 x 20 mm	2,5 mm	1374/9/S1	118/E/2/S1
▧ 30 x 20 mm	2 mm	1374/9/S	118/E/2/S2
▧ 40 x 20 mm	2,5 mm	1374/10/S2	118/E/4/S2
▧ 40 x 20 mm	2 mm	1374/10/S6	118/E/4/S4
▧ 40 x 30 mm	2,5 mm	1374/10/S3	118/E/4/S3
▧ 50 x 30 mm	2,5 mm	1374/11/S1	118/E/6/S1
▧ 50 x 30 mm	2 mm	1374/11/S4	118/E/6/S4
▧ 50 x 40 mm	2,5 mm	1374/11/S2	118/E/6/S5
▧ 50 x 40 mm	2 mm	1374/11/S3	118/E/6/S3
▧ 60 x 30 mm	2,5 mm	1374/12/S2	118/E/7/S3
▧ 60 x 40 mm	2,5 mm	1374/12/S1	118/E/16

END PIECES FOR HOT ROLLED HANDRAILS - PARTENZE PER CORRIMANI LAMINATI A CALDO

Hot hammered - Coniato a caldo



Arteferro bars are produced by paying attention to detail and cut at the ends

Le barre Arteferro sono curate in ogni dettaglio ed anche rifilate alle estremità.

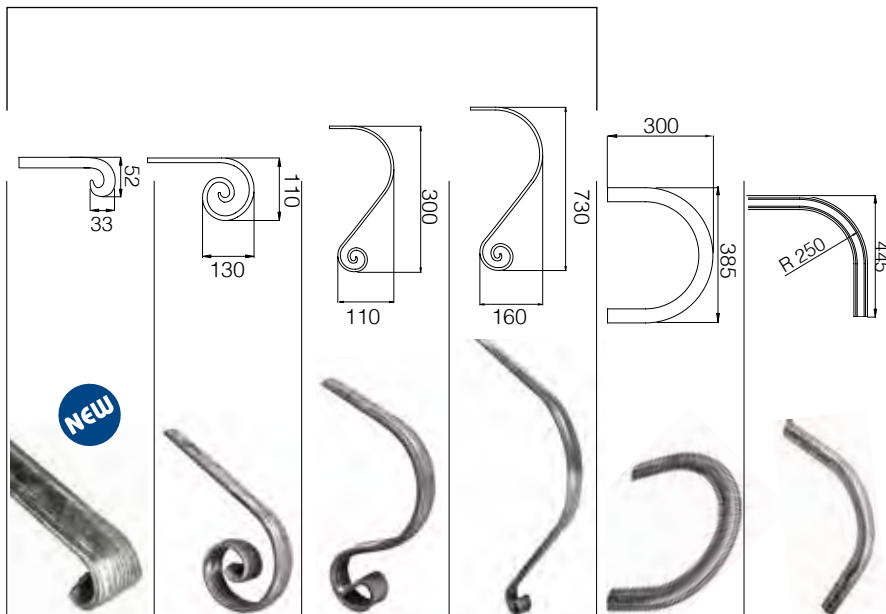

	L 3000 mm	L 6000 mm	Section Sezione							
	Art.	Art.		Art.	Art.	Art.	Art.	Art.	Art.	
	1373/4	1373/4/6000	40 x 11 mm	1817/9/S5	1817/9	1817/5	1817/1	1822/2	1822/13	
	1373/3	1373/3/6000	45 x 12 mm	-	1377/24	1377/11	1817/2	1822/3	1822/14	
	114/A/3	114/A/3/6000	50 x 14 mm	114/B/13/S9	114/B/13	114/B/14	114/B/15	1822/1	1822/12	
	1373/2	1373/2/6000	60 x 16 mm	-	1377/23	1817/8	1817/3	1822/4	1822/15	
	158/9/C	158/9/C/6000	25 x 7 mm	-	-	-	-	-	-	
	158/10/C	158/10/C/6000	30 x 8 mm	-	1819/29	1819/30	1819/13/S	-	-	
	810/A/1	810/A/10	30 x 10 mm	-	812/5/S1	812/1/S4	-	-	-	
	810/A/2	810/A/11	35 x 10 mm	-	812/5	812/1	1819/13	-	-	
	810/A/23	810/A/24	35 x 15 mm	-	812/5/S8	812/1/S8	-	-	-	
	158/12/C	158/12/C/6000	40 x 8 mm	812/6/S	812/6	812/2	1819/14	-	-	
	810/A/3	810/A/12	40 x 10 mm	-	812/7	812/3	1819/15	-	-	
	810/7/C	810/7/C/6000	40 x 12 mm	-	1819/25	1819/21	1819/17	-	-	
	810/A/4	810/A/13	40 x 15 mm	-	812/5/S10	812/3/S1	-	-	-	
	158/47/C	158/47/C/6000	45 x 10 mm	-	1819/27	1819/23	1819/19	-	-	
	158/45/C	158/45/C/6000	50 x 8 mm	-	1819/26	1819/22	1819/19	-	-	
	810/A/5	810/A/14	50 x 10 mm	-	812/8	812/4	1819/16	-	-	
	810/8/C	810/8/C/6000	50 x 12 mm	-	1819/28	1819/24	1819/20	-	-	
	810/A/6	810/A/15	50 x 15 mm	-	812/8/S2	-	-	-	-	
810/A/7	810/A/16	50 x 20 mm	-	1819/28/S	1819/24/S	1819/20/S	-	-		
810/A/9	810/A/18	60 x 20 mm	-	1819/28/S1	1819/24/S1	-	-	-		
	810/1	810/1/6000	20 x 10 mm	-	-	-	-	-	-	
	810/2	810/2/6000	25 x 12,5 mm	-	-	-	-	-	-	
	810/3	810/10	30 x 15 mm	812/5/S	812/5/S9	812/1/S9	-	-	-	
	810/5	810/11	40 x 20 mm	-	812/5/S4	812/3/S2	1819/17/S	-	-	
	810/12	810/12/6000	50 x 25 mm	-	812/5/S6	1819/24/S2	-	-	-	
	810/13	810/13/6000	60 x 30 mm	-	-	-	-	-	-	



**CURVES FOR HOT ROLLED HANDRAILS - CURVE PER CORRIMANI LAMINATI A CALDO**

Tapered manually forged  
Rastremato forgiato manualmente

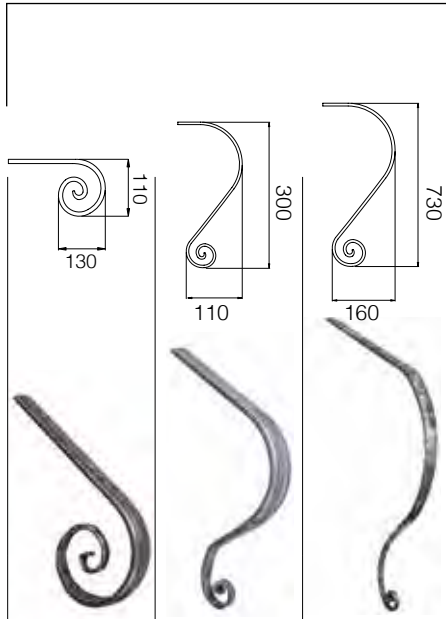

Section  
Sezione

Art. Art. Art.

∅ 40 x 11 mm	1814/17	1814/11	1814/5
∅ 45 x 12 mm	1814/16	1814/10	1814/4
∅ 50 x 14 mm	1814/18	1814/12	1814/6
∅ 60 x 16 mm	1814/15	1814/9	1814/3
∅ 25 x 7 mm	-	-	-
∅ 30 x 8 mm	-	-	-
∅ 30 x 10 mm	-	-	-
∅ 35 x 10 mm	-	-	-
∅ 35 x 15 mm	-	-	-
∅ 40 x 8 mm	-	-	-
∅ 40 x 10 mm	-	-	-
∅ 40 x 12 mm	-	-	-
∅ 40 x 15 mm	-	-	-
∅ 45 x 10 mm	-	-	-
∅ 50 x 8 mm	-	-	-
∅ 50 x 10 mm	-	-	-
∅ 50 x 12 mm	-	-	-
∅ 50 x 15 mm	-	-	-
∅ 50 x 20 mm	-	-	-
∅ 60 x 20 mm	-	-	-
∅ 20 x 10 mm	-	-	-
∅ 25 x 12,5 mm	-	-	-
∅ 30 x 15 mm	-	-	-
∅ 40 x 20 mm	-	-	-
∅ 50 x 25 mm	-	-	-
∅ 60 x 30 mm	-	-	-

The end piece of a handrail is a highly characterising element. Don't allow the processing and beauty of your handrail get spoiled by an unsightly welding between the end and the long bar. The extendable ends resolve this problem: starting with 3 meters rails, we can create the end you need.

La partenza di un corrimano è un elemento altamente caratterizzante. Non lasciare che la lavorazione e la bellezza del tuo corrimano venga interrotta da una antiestetica saldatura tra la partenza e la barra lunga. Le partenze allungate risolvono questo problema: partendo da una barra di 3 metri realizzeremo la partenza che ti serve.



Variable length depending on which end you select  
Lunghezza variabile in base alla partenza scelta

Add "/XL" at the end of the code for your end piece to order extra-long. You'll achieve an excellent result, without any visible welds.

Aggiungi "/XL" alla fine del codice della tua partenza per ordinare la versione extra lunga. Otterrai un risultato eccellente, senza saldature.

**Example - Esempio**

**1817/9/XL** = Extended version  
= Versione allungata



Pag. 247

You can find our supports and accessories in section 17  
Nel capitolo 17 troverai reggicorrimani e accessori

END PIECES FOR HOT ROLLED HANDRAILS - PARTENZE PER CORRIMANI LAMINATI A CALDO



Variable length depending on which end you select.  
Lunghezza variabile in base alla partenza scelta.

Add "/XL" at the end of the code for your end piece to order extra-long. You'll achieve an excellent result, without any visible welds.

Aggiungi "/XL" alla fine del codice della tua partenza per ordinare la versione extra lunga. Otterrai un risultato eccellente, senza saldature.

Hot hammered - Coniato a caldo

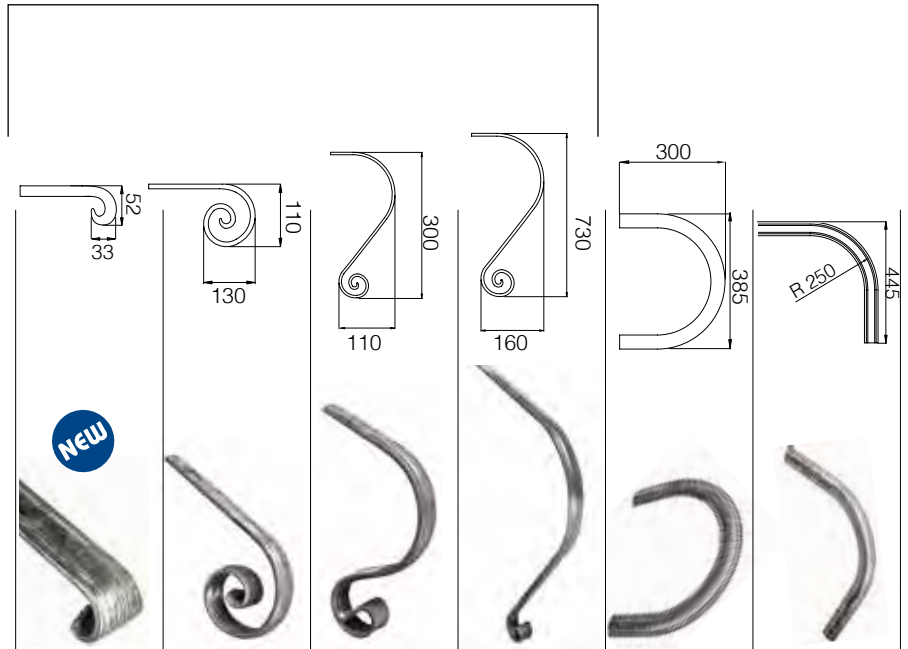

Example - Esempio

**812/14/XL** = Extended version  
= Versione allungata

L 4000 mm		Section - Sezione						
Art.	Art.		Art.	Art.	Art.	Art.	Art.	Art.
811/2	-	58 x 16 mm	-	<b>812/14</b>	1817/7	1817/4	1822/6	1817/7

L 3000 mm L 6000 mm

811/4	811/7	A45 x B15 x C26,5 mm	-	812/13	1377/41	-	-	-
811/5	811/8	A49 x B19 x C28 mm	-	812/15	1377/42	1819/12	-	-
811/3	811/6	A56 x B21 x C32,5 mm	812/12/S	812/12	1377/40	1819/10	-	-

L 3000 mm L 6000 mm

810/B/19	810/B/20	44 x 14 mm	-	1377/18	1377/5	1819/5	-	-
----------	----------	------------	---	---------	--------	--------	---	---

L 3650 mm

114/A/1	-	43 x 7 mm	-	1818/15	114/B/1	1818/5	1822/7	1822/18
114/A/2	-	53 x 9 mm	812/16/S	1818/16	114/B/2	1818/6	1822/8	1822/19

END PIECES FOR COLD ROLLED HANDRAILS - PARTENZE PER CORRIMANI LAMINATO A FREDDO

L 2500 mm

811/1	-	56 x 17 mm	-	-	-	-	1822/5	1822/16
-------	---	------------	---	---	---	---	--------	---------

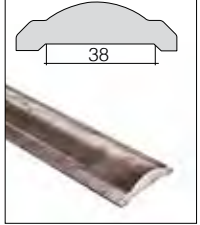
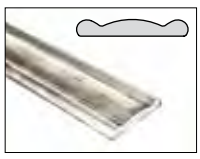
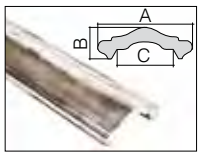
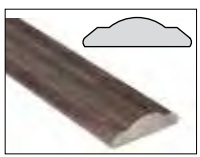

**CURVES FOR HOT ROLLED HANDRAILS**  
**CURVE PER CORRIMANI LAMINATI A CALDO**

Tapered manually forged  
 Rastremato forgiato manualmente

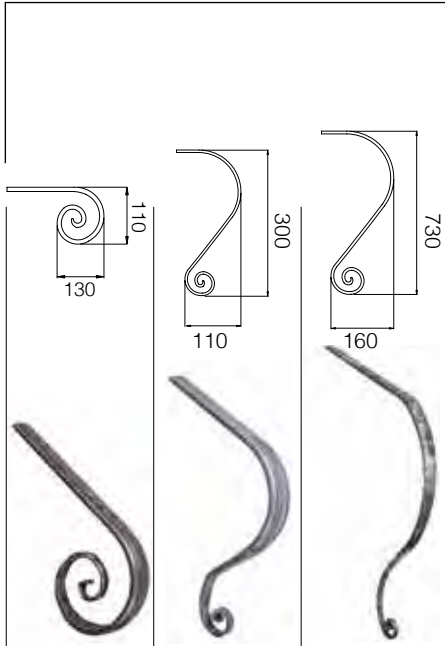

Section - Sezione

	Art.	Art.	Art.
☒ 58 x 16 mm	1814/14	1814/8	1814/2

☒ A45 x B15 x C26,5 mm	-	-	-
☒ A49 x B19 x C28 mm	-	-	-
☒ A56 x B21 x C32,5 mm	-	-	-

☒ 44 x 14 mm	-	-	-
--------------	---	---	---

☒ 43 x 7 mm	-	-	-
☒ 53 x 9 mm	-	-	-

**END PIECES FOR COLD ROLLED HANDRAILS**  
**PARTENZE PER CORRIMANI LAMINATO A FREDDO**

☒ 56 x 17 mm	812/9	812/10	812/11
--------------	-------	--------	--------



**END PIECES FOR MANUALLY FORGED HANDRAILS  
PARTENZE PER CORRIMANI FORGIATI MANUALMENTE**



Variable length depending on which end you select  
Lunghezza variabile in base alla partenza scelta

Add "/XL" at the end of the code for your end piece to order extra-long. You'll achieve an excellent result, without any visible welds.

Aggiungi "/XL" alla fine del codice della tua partenza per ordinare la versione extra lunga. Otterrai un risultato eccellente, senza saldature.

Hot hammered - Coniati a caldo

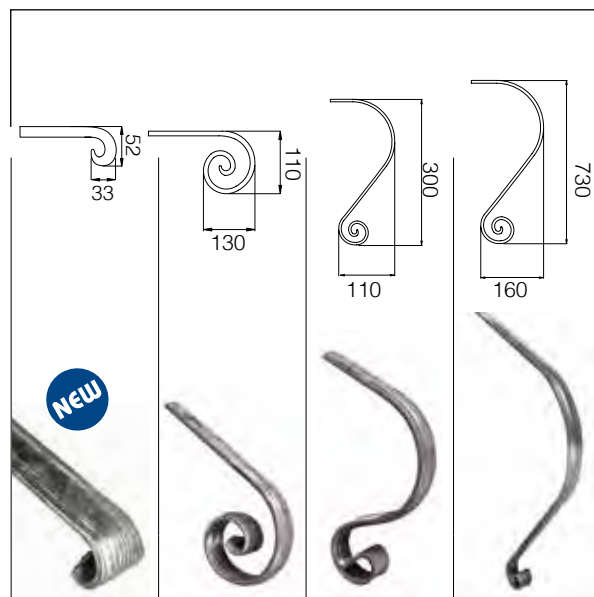

**Example - Esempio**

**1820/11/XL** = Extended version  
= Versione allungata

	L 2000 mm		Section - Sezione				
Art.				Art.	Art.	Art.	Art.
114/1	-	∅ 56 x 14 mm		-	-	-	-

L 2000 mm

	114/2	-	∅ 58 x 17 mm	-	-	-	-
--	-------	---	--------------	---	---	---	---

**END PIECES FOR COLD ROLLED HANDRAILS  
PARTENZE PER CORRIMANI LAMINATO A FREDDO**

L 3000 mm L 6000 mm

	811/5/T	811/8/T	∅ A50 x B14 x C25,4 mm	-	812/15/T	1377/42/T	1820/11
	811/3/T	811/6/T	∅ A59 x B16,5 x C32,5 mm	812/12/T/S	812/12/T	1377/10/T	1820/9
	811/9/T	811/10/T	∅ A80 x B18,5 x C41 mm	-	1820/14	1820/13	1820/12
	811/4/T	811/7/T	∅ A41 x B11 x C25,5 mm	-	812/13/T	1377/41/T	1820/10

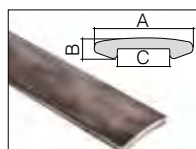

L 3000 mm L 6000 mm

810/B/13/T	810/B/16/T	∅ A40 x B8,5 x C20,7 mm	-	1377/20/T	1377/7/T	1820/5
810/B/14/T	810/B/17/T	∅ A45 x B9 x C20,8 mm	-	1377/21/T	1377/8/T	1820/6
810/B/15/T	810/B/18/T	∅ A50 x B9 x C25,7 mm	-	1377/22/T	1377/9/T	1820/7

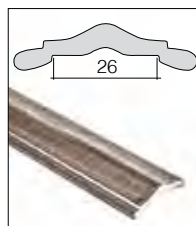

L 3000 mm L 6000 mm

810/B/19/T	810/B/20/T	∅ 43 x 11 mm	-	1377/18/T	1377/5/T	1820/8
------------	------------	--------------	---	-----------	----------	--------

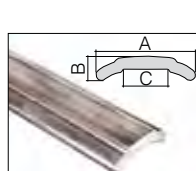

L 3000 mm L 6000 mm

810/B/1/T	810/B/5/T	∅ A35 x B9 x C15 mm	-	1377/14/T	1377/1/T	1820/1
810/B/2/T	810/B/6/T	∅ A41 x B9 x C21,1 mm	-	1377/15/T	1377/2/T	1820/2
810/B/3/T	810/B/7/T	∅ A45 x B14 x C20,8 mm	-	1377/16/T	1377/3/T	1820/3
810/B/4/T	810/B/8/T	∅ A50 x B14 x C20,7 mm	-	1377/17/T	1377/4/T	1820/4



**END PIECES FOR MANUALLY FORGED HANDRAILS  
PARTENZE PER CORRIMANI FORGIATI MANUALMENTE**

Tapered manually forged  
Rastremato forgiato manualmente

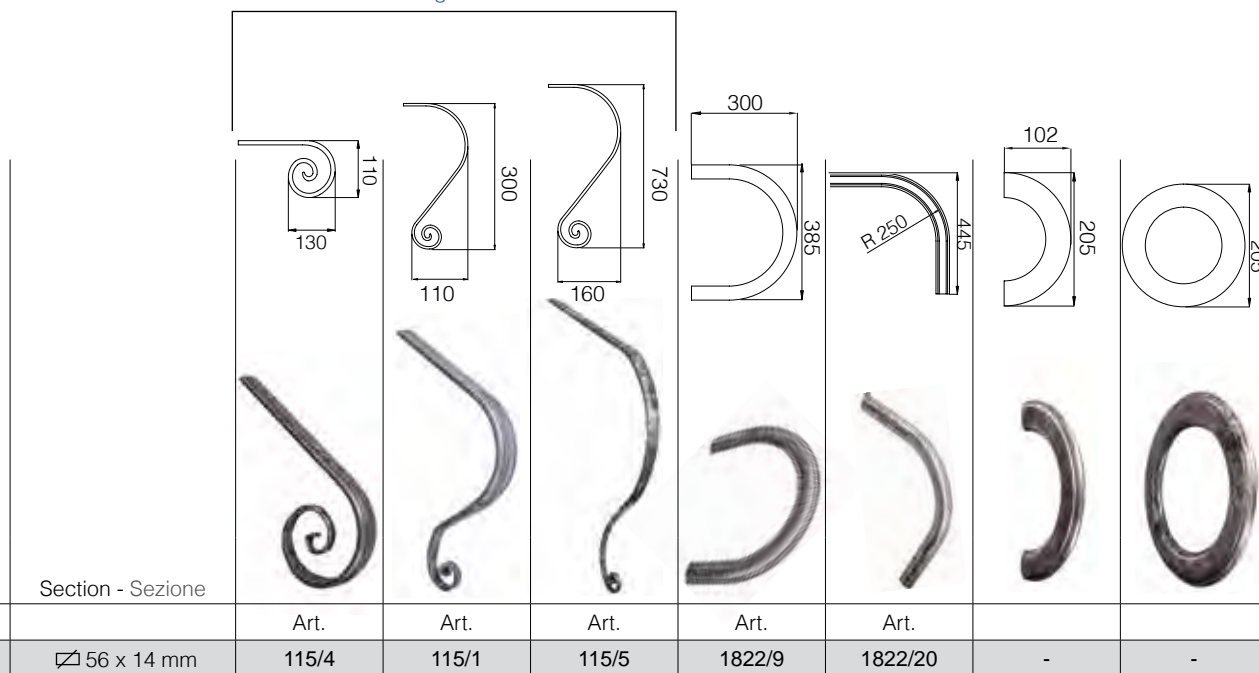

Section - Sezione

	Art.	Art.	Art.	Art.	Art.		
∅ 56 x 14 mm	115/4	115/1	115/5	1822/9	1822/20	-	-

∅ 58 x 17 mm	115/3	115/2	114/B/3	1822/10	1822/21	-	-
--------------	-------	-------	---------	---------	---------	---	---

**END PIECES FOR COLD ROLLED HANDRAILS  
PARTENZE PER CORRIMANI LAMINATO A FREDDO**

∅ A50 x B14 x C25,4 mm	-	-	-	-	-	1825/28	1825/18
∅ A59 x B16,5 x C32,5 mm	-	-	-	-	-	-	1825/16
∅ A80 x B18,5 x C41 mm	-	-	-	-	-	1825/27	1825/17
∅ A41 x B11 x C25,5 mm	-	-	-	-	-	-	-

∅ A40 x B8,5 x C20,7 mm	-	-	-	-	-	1825/23	1825/13
∅ A45 x B9 x C20,8 mm	-	-	-	-	-	1825/24	1825/14
∅ A50 x B9 x C25,7 mm	-	-	-	-	-	1825/25	1825/15

∅ 43 x 11 mm	-	-	-	-	-	-	-
--------------	---	---	---	---	---	---	---

∅ A35 x B9 x C15 mm	-	-	-	-	-	1825/19	1825/9
∅ A41 x B9 x C21,1 mm	-	-	-	-	-	1825/20	1825/10
∅ A45 x B14 x C20,8 mm	-	-	-	-	-	1825/21	1825/11
∅ A50 x B14 x C20,7 mm	-	-	-	-	-	1825/22	1825/12

**ENDS FOR COLD LAMINATED HANDRAILS**  
**PARTENZE PER CORRIMANI LAMINATI A FREDDO**

Hot hammered - Coniato a caldo



Variable length depending on which end you select  
 Lunghezza variabile in base alla partenza scala

Add "/XL" at the end of the code for your end piece to order extra-long. You'll achieve an excellent result, without any visible welds.

Aggiungi "/XL" alla fine del codice della tua partenza per ordinare la versione extra lunga. Otterrai un risultato eccellente, senza saldature.

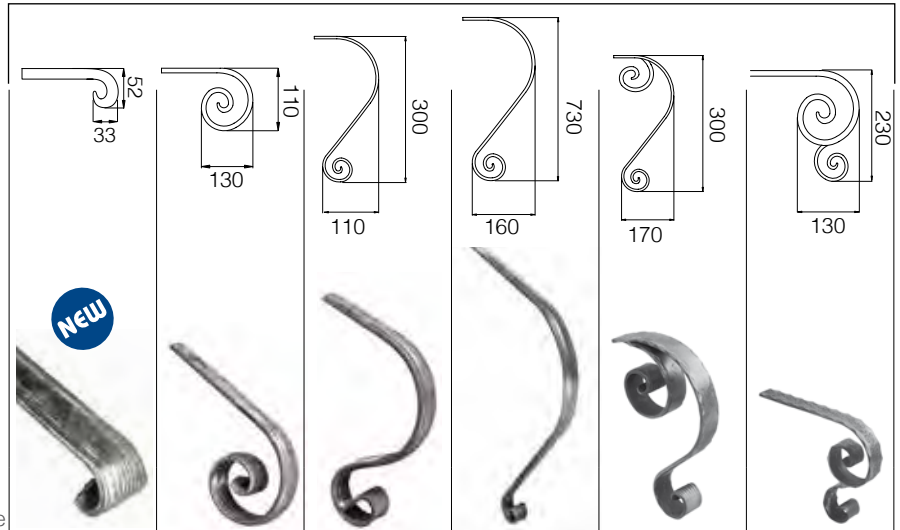

**Example - Esempio**

**116/10/XL** = Extended version  
 = Versione allungata

L 3000 mm L 6000 mm Section - Sezione

Art.	Art.	Section - Sezione	Art.	Art.	Art.	Art.	Art.	Art.	Art.
1837/8	-	∅ 57 x 7 mm	-	-	-	-	-	-	-

114/9	114/9/6000	∅ 30 x 8 mm	1818/11/S	1818/11	1818/7	1818/1	-	-	-
1838/2	1838/2/6000	∅ 40 x 8 mm	-	1818/12	1818/8	1818/2	1378/14/S	1378/5/S	-
1838/3	1838/3/6000	∅ 50 x 8 mm	-	1818/13	1818/9	1818/3	-	-	-
1838/4	1838/4/6000	∅ 60 x 8 mm	-	1818/14	1818/10	1818/4	-	-	-

114/10	114/10/6000	∅ 40 x 8 mm	-	116/14	116/6	114/B/9	1378/15	1378/6	-
<b>Wavy grooves - Rigature ondulate</b>									
114/10/S	-	∅ 40 x 8 mm	-	116/14/S	116/6/S	-	-	-	-

<b>Straight grooves - Rigature dritte</b>									
114/5	114/5/6000	∅ 40 x 8 mm	116/10/S7	116/10	116/2	114/B/5	1378/11	1378/2	-
114/13	114/13/6000	∅ 50 x 8 mm	-	116/10/S1	116/2/S1	114/B/5/S	1378/11/S1	1378/2/S	-
114/14	114/14/6000	∅ 40 x 6 mm	-	116/10/S3	116/2/S2	114/B/5/S3	-	-	-

118/14	118/14/6000	∅ 40 x 8 mm	-	116/37	116/36	114/B/12	1378/18	1378/9	-
118/13	118/13/6000	∅ 30 x 8 mm	-	116/37/S1	116/36/S1	-	-	-	-



**ENDS FOR COLD LAMINATED HANDRAILS**  
**PARTENZE PER CORRIMANI LAMINATI A FREDDO**

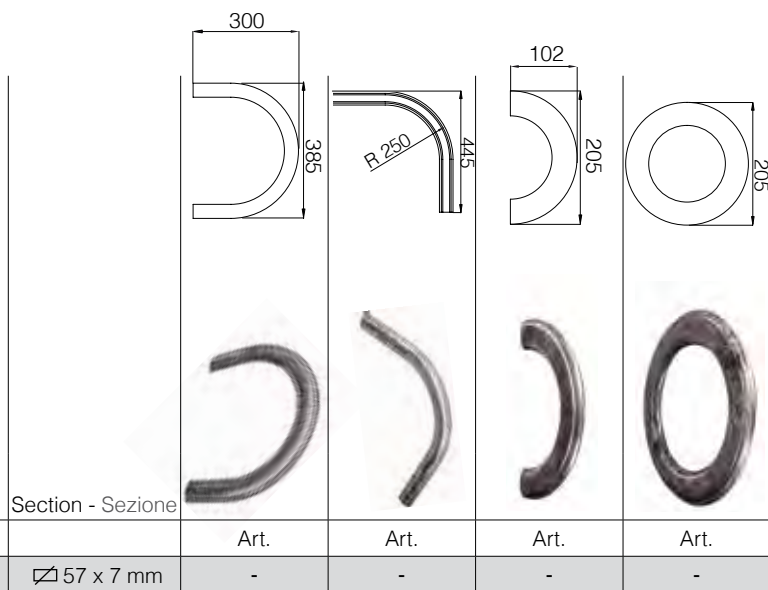

Section - Sezione

Art. Art. Art. Art.

∅ 57 x 7 mm

- - - -

∅ 30 x 8 mm	1825/9	1825/5	-	-
∅ 40 x 8 mm	1825/2	1825/6	-	-
∅ 50 x 8 mm	1825/3	1825/7	-	-
∅ 60 x 8 mm	1825/4	1825/8	-	-
∅ 40 x 8 mm	116/A/3	116/30	-	-
∅ 40 x 8 mm	-	-	-	-
∅ 40 x 8 mm	116/A/9	116/26	-	-
∅ 50 x 8 mm	-	-	-	-
∅ 40 x 6 mm	-	-	-	-
∅ 40 x 8 mm	116/A/16	116/39	-	-
∅ 30 x 8 mm	-	-	-	-



Pag. 247

You can find our supports and accessories in section 17  
Nel capitolo 17 troverai reggicorrimani e accessori



Hot hammered - Coniato a caldo



Variable length depending on which end you select  
Lunghezza variabile in base alla partenza scelta

Add "/XL" at the end of the code for your end piece to order extra-long. You'll achieve an excellent result, without any visible welds.

Aggiungi "/XL" alla fine del codice della tua partenza per ordinare la versione extra lunga. Otterrai un risultato eccellente, senza saldature.

Example - Esempio

**116/11/XL** = Extended version  
= Versione allungata

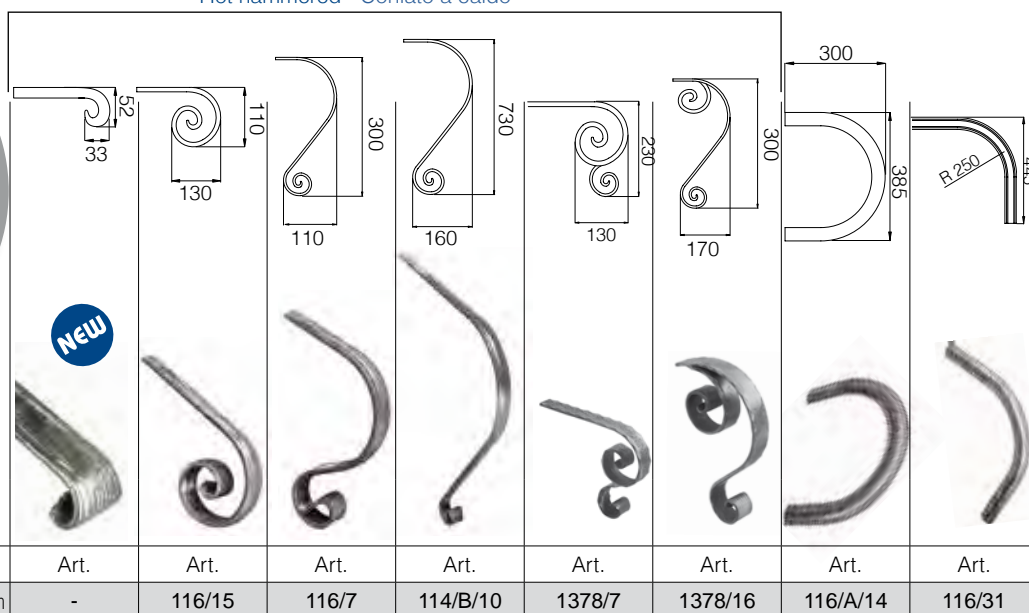

	L 3000 mm	L 6000 mm	Sezione								
	Art.	Art.		Art.	Art.	Art.	Art.	Art.	Art.	Art.	Art.
	114/11	114/11/6000	40 x 8 mm	-	116/15	116/7	114/B/10	1378/7	1378/16	116/A/14	116/31
	114/12	114/12/6000	40 x 8 mm	-	116/16	116/8	114/B/11	1378/8	1378/17	116/A/15	116/32
	114/8	114/8/6000	40 x 8 mm	-	116/13	116/5	114/B/8	1378/5	1378/14	116/A/12	116/29
	114/6	114/6/6000	40 x 8 mm	-	116/11	116/3	114/B/6	1378/3	1378/12	116/A/10	116/27
	114/7	114/7/6000	40 x 8 mm	-	116/12	116/4	114/B/7	1378/4	1378/13	116/A/11	116/28
	<b>114/4</b>	<b>114/4/6000</b>	40 x 8 mm	-	116/9	116/1	114/B/4	1378/1	1378/10	116/A/8	116/25

Slotted steel for plastic, moldable handrail  
Ferro dentellato per corrimano in plastica modellabile  
Art. 118/F/9



Art. 118/F/10  
40 x 8 mm  
L 1500 mm

Moldable plastic handrail Rolls of 25 metres  
Plastica modellabile Rotoli da 25 mt

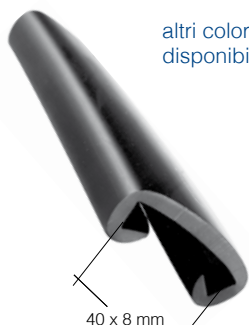

Art. 118/F/9  
black - nero  
for/per 40 x 8 mm

altri colori disponibili / another colors available

- gold oro
- blue blu
- white bianco

Tubular iron handrail 1.5 mm thick.  
Corrimano tubolare in ferro spessore 1,5 mm

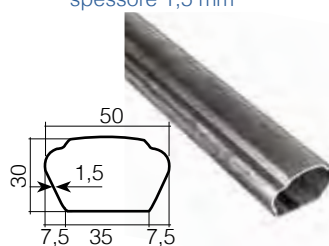

Art. 118/F/7/3000  
50 x 30 mm  
L 3000 mm  
Art. 118/F/7  
50 x 30 mm  
L 6000 mm

Tubular steel handrail 1.5 mm thick.  
Corrimano tubolare in ferro spessore 1,5 mm

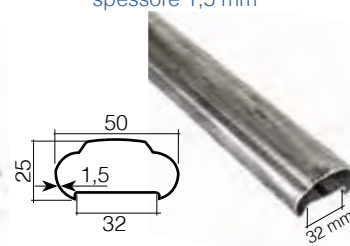





Art. 118/F/8/3000  
50 x 25 mm  
L 3000 mm  
Art. 118/F/8  
50 x 25 mm  
L 6000 mm

## HANDRAIL PROFILES COLD ROLLED CORRIMANI PROFILI LAMINATI A FREDDO

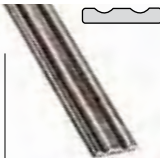
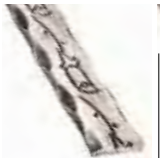
Handrails and End pieces - Corrimani e Partenze

Worked on one side - Lavorato su un lato

Section Sezione							
	L 4000 mm	L 3000 mm	L 3000 mm	L 3000 mm	L 3000 mm	L 3000 mm	L 3000 mm
	Art.	Art.	Art.	Art.	Art.	Art.	Art.
∅ 16 x 3 mm	1839/25	-	-	-	-	-	-
∅ 30 x 5 mm	-	1838/8	-	-	-	-	-
∅ 31 x 5 mm	-	-	1834/2	1834/3	-	-	1834/4
∅ 32 x 5 mm	-	-	-	-	1834/1	-	-
∅ 32 x 6 mm	-	-	-	-	-	1834/9	-
	L 6000 mm	L 6000 mm	L 6000 mm	L 6000 mm	L 6000 mm	L 6000 mm	L 6000 mm
∅ 16 x 3 mm	-	-	-	-	-	-	-
∅ 30 x 5 mm	-	1838/8/6000	-	-	-	-	-
∅ 31 x 5 mm	-	-	1834/2/6000	1834/3/6000	-	-	1834/4/6000
∅ 32 x 5 mm	-	-	-	-	1834/1/6000	-	-
∅ 32 x 6 mm	-	-	-	-	-	1834/9/6000	-

Section Sezione						
	L 3000 mm	L 3000 mm	L 3000 mm	L 3000 mm	L 3000 mm	L 3000 mm
	Art.	Art.	Art.	Art.	Art.	Art.
∅ 17 x 5 mm	-	-	-	-	-	114/A/6
∅ 30 x 5 mm	-	-	-	-	114/A/5	-
∅ 31 x 5 mm	-	1834/6	-	-	-	-
∅ 32 x 6 mm	-	-	1834/7	-	-	-
∅ 32 x 7 mm	1834/5	-	-	-	-	-
∅ 32 x 9 mm	-	-	-	1834/8	-	-
∅ 57 x 17 mm	-	-	-	-	-	-
	L 6000 mm	L 6000 mm	L 6000 mm	L 6000 mm	L 6000 mm	L 6000 mm
∅ 17 x 5 mm	-	-	-	-	-	114/A/6/6000
∅ 30 x 5 mm	-	-	-	-	114/A/5/6000	-
∅ 31 x 5 mm	-	1834/6/6000	-	-	-	-
∅ 32 x 6 mm	-	-	-	-	-	-
∅ 32 x 7 mm	1834/5/6000	-	1834/7/6000	-	-	-
∅ 32 x 9 mm	-	-	-	1834/8/6000	-	-
∅ 57 x 17 mm	-	-	-	-	-	-

Section Sezione				
	L 3000 mm	L 3000 mm	L 2000 mm	L 2000 mm
	Art.	Art.	Art.	Art.
∅ 20 x 4 mm	-	1837/5	-	-
∅ 23 x 4 mm	1837/1	-	-	-
∅ 27 x 5 mm	1837/2	-	-	-
∅ 30 x 6 mm	-	1837/6	-	-
∅ 37 x 7 mm	1837/3	-	-	-
∅ 41 x 8 mm	1837/4	-	-	-
∅ 57 x 17 mm	-	-	-	-
∅ 100 x 8 mm	-	-	1370/1	1370/3
∅ 120 x 8 mm	-	-	1370/2	1370/4
	L 6000 mm	L 6000 mm	L 6000 mm	L 6000 mm
∅ 20 x 4 mm	1837/1/6000	-	-	-
∅ 23 x 4 mm	1837/2/6000	-	-	-
∅ 27 x 5 mm	-	1837/6/6000	-	-
∅ 30 x 6 mm	1837/3/6000	-	-	-
∅ 37 x 7 mm	1837/4/6000	-	-	-
∅ 41 x 8 mm	-	-	-	-
∅ 57 x 17 mm	-	-	-	-
∅ 100 x 8 mm	-	-	1370/1/6000	1370/3/6000
∅ 120 x 8 mm	-	-	1370/2/6000	1370/4/6000

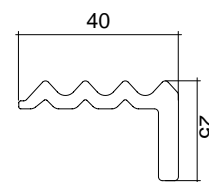

L-Profile  
Profilo ad elle



Rolled only on the 40 mm side  
Lavorato solo sul lato da 40 mm

Art. 810/A/19/T  
∅ 25 x 40 mm  
L 3000 mm

Art. 810/A/20/T  
∅ 25 x 40 mm  
L 6000 mm

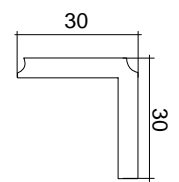

Angular profile  
Profilo angolare



Only hammered on one side / 2 angles  
Lavorato solo su un lato / 2 angoli

Art. 1373/1  
30 x 30 x 4 mm  
L 3000 mm

Art. 1373/1/6000  
30 x 30 x 4 mm  
L 6000 mm

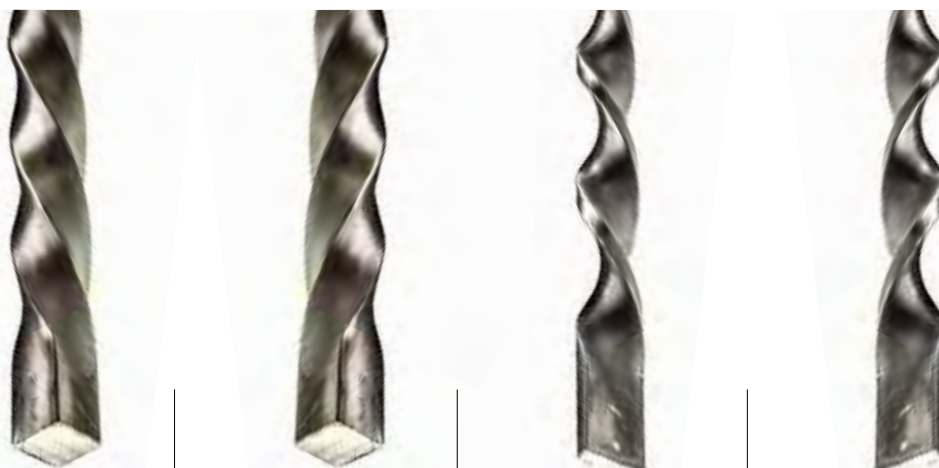

Section Sezione	Twisted to the left Attorcigliatura sinistra		Twisted to the right Attorcigliatura destra		Twisted to the left Attorcigliatura sinistra		Twisted to the right Attorcigliatura destra	
	L 3000 mm	L 6000 mm	L 3000 mm	L 6000 mm	L 3000 mm	L 6000 mm	L 3000 mm	L 6000 mm
	Art.	Art.	Art.	Art.	Art.	Art.	Art.	Art.
∅ 8 x 8 mm	118/H/18	118/H/7	-	-	-	-	-	-
∅ 10 x 10 mm	118/H/19	118/H/8	-	-	-	-	-	-
∅ 12 x 12 mm	118/H/20	118/H/9	-	-	-	-	-	-
∅ 14 x 14 mm	118/H/21	118/H/10	-	-	-	-	-	-
∅ 16 x 16 mm	118/H/22	118/H/11	-	-	-	-	-	-
∅ 18 x 18 mm	118/H/23	118/H/12	-	-	-	-	-	-
∅ 20 x 20 mm	118/H/24	118/H/13	-	-	-	-	-	-
∅ 25 x 25 mm	118/H/25	118/H/14	-	-	-	-	-	-
∅ 30 x 30 mm	118/H/26	118/H/15	1806/19	1806/22	-	-	-	-
∅ 40 x 40 mm	1806/14	1806/16	1806/18	1806/21	-	-	-	-
∅ 50 x 50 mm	1806/13	1806/15	1806/17	1806/20	-	-	-	-
∇ 20 x 6 mm	-	-	-	-	118/H/16	118/H/5	-	-
∇ 30 x 8 mm	-	-	-	-	118/H/17	118/H/6	-	-
∇ 50 x 25 mm	-	-	-	-	1806/24	1806/26	1806/28	1806/30
∇ 60 x 30 mm	-	-	-	-	1806/23	1806/25	1806/27	1806/29

1 groove on each side  
1 solco per lato

3 grooves on each side  
3 solchi per lato



Section Sezione	Twisted to the left Attorcigliatura sinistra		Twisted to the right Attorcigliatura destra		Twisted to the left Attorcigliatura sinistra		Twisted to the right Attorcigliatura destra	
	L 3000 mm	L 6000 mm	L 3000 mm	L 6000 mm	L 3000 mm	L 6000 mm	L 3000 mm	L 6000 mm
	Art.	Art.	Art.	Art.	Art.	Art.	Art.	Art.
∅ 30 x 30 mm	1807/3	1807/6	1807/9	1807/12	1807/15	1807/18	1807/21	1807/24
∅ 40 x 40 mm	1807/2	1807/5	1807/8	1807/11	1807/14	1807/17	1807/20	1807/23
∅ 50 x 50 mm	1807/1	1807/4	1807/7	1807/10	1807/13	1807/16	1807/19	1807/22

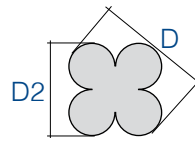
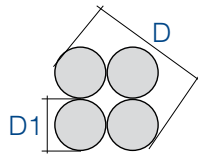
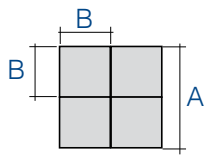

## Twisted bars - Torciglioni

### Grooved tube Tubo rigato



Ø 40 mm  
Thickn.-Spess. 2 mm  
**Art. 1794/9**  
L 3000 mm

**Art. 1794/9/6000**  
L 6000 mm

Ø 30 mm  
Thickn.-Spess. 1,5 mm  
**Art. 1794/10**  
L 3000 mm

**Art. 1794/10/6000**  
L 6000 mm

### Twisted tube Tubo attorcigliato



**Art. 118/F/6**  
Ø 20 x 20 mm  
L 2000 mm  
Thickn.-Spess 2 mm

### Hot grooved rope on 4 sides and beveled on 4 angles Fune solcata a caldo 4 lati e smussata 4 angoli

- L 2000 mm
- Art. 117/10**
- Ø 14 x 14 mm
- Art. 117/11**
- Ø 16 x 16 mm
- Art. 117/12**
- Ø 18 x 18 mm
- Art. 117/13**
- Ø 20 x 20 mm
- Art. 117/14**
- Ø 30 x 30 mm



**Art. 626/1**  
40 x 40 mm  
Ø 3,5 mm  
L 2900 mm

**Art. 626/2**  
50 x 50 mm  
Ø 5 mm  
L 2900 mm

### Twisted cross iron Ferro croce attorcigliato

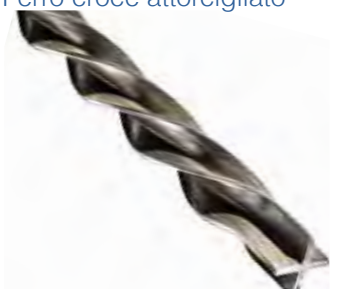

Section Sezione	Section Sezione	
A	B	L 2000 mm
		Art.
Ø 12 mm	Ø 6 mm	118/F/1
Ø 14 mm	Ø 7 mm	-
Ø 16 mm	Ø 8 mm	118/F/2
Ø 18 mm	-	-
Ø 20 mm	Ø 10 mm	118/F/3
Ø 22 mm	-	-
Ø 24 mm	Ø 12 mm	118/F/4
Ø 26 mm	-	-
Ø 28 mm	Ø 14 mm	118/F/5
Ø 30 mm	-	-

Section Sezione	Section Sezione		
D	D1	L 2700 mm	L 5400 mm
			Art.
Ø 12 mm	-	-	-
Ø 14 mm	-	-	-
Ø 16 mm	Ø 6 mm	119/1	119/1/5400
Ø 18 mm	-	-	-
Ø 20 mm	Ø 8 mm	119/2	119/2/5400
Ø 22 mm	-	-	-
Ø 24 mm	-	-	-
Ø 26 mm	-	-	-
Ø 28 mm	-	-	-
Ø 30 mm	Ø 12 mm	119/3	119/3/5400

Section Sezione	
D2	L 3000 mm
	Art.
Ø 12 mm	626/3
Ø 14 mm	626/4
Ø 16 mm	626/5
Ø 18 mm	626/6
Ø 20 mm	626/7
Ø 22 mm	626/8
Ø 26 mm	626/9
-	-
-	-
-	-



Collars - Fascette

## HOT ROLLED PROFILES - PROFILI LAMINATI A CALDO



Art. 158/3  
 ▧ 14 x 4 mm  
 L 4000 mm



		Art.	
	for-per 2 bars-barre 8 x 8 mm	158/20	
H 8 mm	for-per 4 bars-barre 8 x 8 mm	158/21	
	for-per 3 bars-barre 8 x 8 mm	158/22	
	for-per 2 bars-barre 10 x 5 mm	158/23	
H 10 mm	for-per 3 bars-barre 10 x 10 mm	158/24	
	for-per 2 bars-barre 10 x 10 mm	158/25	
	for-per 8 x 8 mm + 2 bars-barre 10 x 5 mm	1848/2	
	for-per 3 bars-barre 10 x 5 mm	1848/6	
	for-per 2 bars-barre 12 x 6 mm	158/26	
	for-per 3 bars-barre 12 x 6 mm	158/27	
H 12 mm	for-per 4 bars-barre 12 x 6 mm	158/28	
	for-per 6 bars-barre 12 x 6 mm	158/29	
	for-per 2 bars-barre 12 x 12 mm	158/30	
	for-per round-tondo 16 mm + 2 bars-barre 12 x 6 mm	1848/3	
	for-per 5 bars-barre 12 x 6 mm	1848/4	
H 16 mm	for-per 16 x 16 mm + 2 bars-barre 16 x 8 mm	1848/1	
H 20 mm	for-per 2 barre 20 x 6 mm	1848/5	





**HOT ROLLED PROFILES - PROFILI LAMINATI A CALDO**

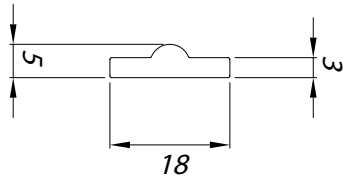

Art. 158/4  
 ▽ 18 x 5 mm  
 L 4000 mm

Art.

H 12 mm	for-per 2 bars-barre 12 x 12 mm	85/8	
	per 3 bars-barre 12 x 12 mm	85/9	
	for-per 2 bars-barre 12 x 6 mm	158/31	
	for-per 4 bars-barre 12 x 12 mm	158/32	
	for-per 5 bars-barre x 6 mm	158/33	
	for-per 12 x 12 mm + 4 bars-barre 12 x 6 mm	1848/11	
H 14 mm	for-per 12 x 12 mm + 3 bars-barre 12 x 6 mm	1848/12	
	for-per 14 x 14 mm + 2 bars-barre 14 x 8 mm	181/7	
	for-per 14 x 14 mm + 1 bar-barra 14 x 8 mm	181/8	
	for-per 2 bars-barre 14 x 8 mm	1848/7	
	for-per 3 bars-barre 14 x 8 mm	1848/8	
	for-per 14 x 14 mm + 4 bars-barre 12 x 6 mm	1848/13	
	for-per 3 bars-barre 14 x 14 mm	1848/15	
	for-per 2 bars-barre 14 x 14 mm + 2 bars-barre 12 x 6 mm	1848/16	
	for-per 14 x 14 mm + 2 bars-barre 14 x 6 mm	1848/14	
	for-per 14 x 14 mm + 1 bars-barre 16 x 6 mm	1848/20	
H 16 mm	for-per 14 x 14 mm + 4 bars-barre 16 x 6 mm	1848/21	
	for-per 4 bars-barre 16 x 6 mm	1848/9	
	for-per 16 x 16 mm + 2 bars-barre 16 x 6 mm	1848/17	
H 25 mm	for-per 1 bar-barra 25 x 25 mm	1848/18	
H 30 mm	for-per 1 bar-barra 30 x 30 mm	1848/19	
	for-per 2 bars-barre 30 x 4 mm	1848/10	

### Collars - Fascette

### HOT ROLLED PROFILES - PROFILI LAMINATI A CALDO



Art. 158/1  
 ∅ 14 x 4 mm  
 L 4000 mm

Section - Sezione	L 3000 mm	L 4000 mm	L 6000 mm
	Art.	Art.	Art.
∅ 14 x 4 mm	-	158/1	-
∅ 18 x 5 mm	-	158/2	-
∅ 25 x 8 mm	158/49	-	158/52
∅ 30 x 8 mm	158/50	-	158/53
∅ 40 x 8 mm	158/51	-	158/54

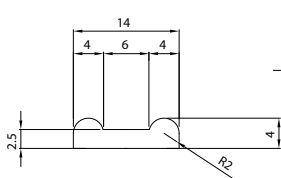

H  
12 mm



H  
14 mm

H  
16 mm

	Art.	
for-per 4 bars-barre 6 x 6 mm	158/13	
for-per 2 bars-barre 12 x 6 mm	158/14	
for-per 3 bars-barre 12 x 6 mm	158/15	
for-per 4 bars-barre 12 x 6 mm	158/16	
for-per 6 bars-barre 12 x 6 mm	158/17	
for-per 5 bars-barre 12 x 6 mm	1851/1	
for-per 2 bars-barre ∅ 12 mm	1851/2	
for-per 3 bars-barre ∅ 12 mm	1851/3	
for-per 14 x 14 mm + 2 bars-barre 12 x 6 mm	1851/5	
for-per 14 x 14 mm + 4 bars-barre 12 x 6 mm	1851/6	
for-per 1 bar-barra 14 x 14 mm	1851/4	
for-per 16 x 16 mm + 2 bars-barre 16 x 6 mm	1851/7	
for-per 16 x 16 mm + 4 bars-barre 16 x 6 mm	1851/8	
for-per 16 x 16 mm + 2 bars-barre 16 x 4 mm	1851/9	
for-per 16 x 16 mm + 4 bars-barre 16 x 4 mm	1851/10	
for-per 2 bars-barre 16 x 8 mm	1851/11	
for-per 3 bars-barre 16 x 8 mm	1851/12	
for-per 1 bar-barra 16 x 16 mm	1851/13	

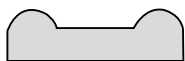

Art. 158/2  
 ∅ 18 x 5 mm  
 L 4000 mm

H  
18 mm

H  
25 mm

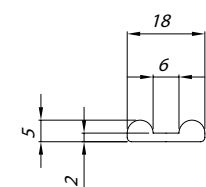

for-per 4 bars-barre 10 x 10 mm	158/18	
for-per 1 bar-barra 10 x 10 mm	158/19	
for-per 2 bars-barre 25 x 12 mm	1851/26	
for-per 2 bars-barre 12 x 12 mm	1851/27	
for-per 3 bars-barre 16 x 16 mm	1851/28	
for-per 1 bar-barra 25 x 25 mm	1851/29	
for-per 1 bar-barra 30 x 30 mm	1851/30	

## HOT ROLLED PROFILES - PROFILI LAMINATI A CALDO

Collars - Fascette

Section - Sezione	L 4000 mm
	Art.
▧ 11 x 3 mm	158/5
▧ 14 x 4 mm	158/6
▧ 16 x 5 mm	158/7
▧ 21 x 6 mm	158/8



Art. 158/5

▧ 11 x 3 mm

L 4000 mm

for-per 2 bars-barre 10 x 5 mm

Art.

158/34

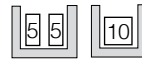

H  
10 mm

for-per 3 bars-barre 10 x 5 mm

158/35

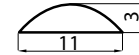
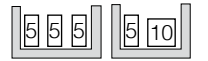

Art. 158/6

▧ 14 x 4 mm

L 4000 mm

for-per 3 bars-barre Ø 10 mm

1846/3

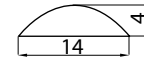
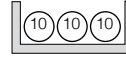

for-per 2 bars-barre Ø 10 mm

1851/17

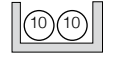

for-per 4 bars-barre 12 x 6 mm

1851/14



for-per 3 bars-barre Ø 12 mm

1851/15



for-per 2 bars-barre Ø 12 mm

1851/16

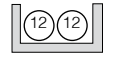

for-per 3 bars-barre 12 x 12 mm

1851/19

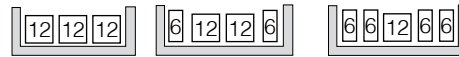

for-per 12 x 12 mm + 2 bars-barre 12 x 6 mm

1851/20

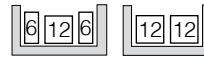

for-per 14 x 14 mm + 2 bars-barre 12 x 6 mm

1851/21

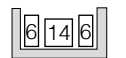

for-per 2 bars-barre dia 14 mm

1851/18/S1

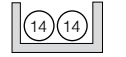

for-per 3 bars-barre dia 14 mm

1851/18

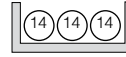

for-per 2 bars-barre 16 x 4 mm

158/36



for-per 3 bars-barre 16 x 4 mm

158/37



for-per 1 bar-barra 16 x 16 mm

1851/22

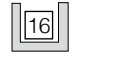

for-per 16 x 16 mm + 1 bar-barra 16 x 6 mm

1851/23



for-per 4 bars-barre 16 x 4 mm

1851/24

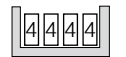

for-per 5 bars-barre 16 x 4 mm

1851/25



for-per 2 bars-barre 20 x 4 mm

158/38



for-per 3 bars-barre 20 x 4 mm

158/39



for-per 2 bars-barre 20 x 6 mm

158/40

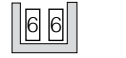

for-per 3 bars-barre 20 x 6 mm

158/41



for-per 2 bars-barre 25 x 4 mm

158/42



for-per 3 bars-barre 25 x 4 mm

158/43



for-per 2 bars-barre 25 x 6 mm

158/44





# CUSTOMER SERVICE ASSISTENZA CLIENTI

Our back office staff speaks five languages fluently,  
and is at disposal to give you all the information  
and support you need.

Il nostro staff di back office parla fluentemente cinque  
lingue diverse ed è a vostra disposizione per darvi tutte le  
informazioni ed il supporto che vi servono.

**+39 0445 580 580**

from Monday to Friday  
dal Lunedì al Venerdì  
**08.00 -18.00 (GMT+1)**

**info@arteferro.com**

**www.arteferro.com**





Arteferro pierced and shaped bars are items with of a wrought iron symbol. Beyond a protective function, they confer a touch of elegance that embellishes the buildings into which they are installed. Arteferro pierced bars are available in lengths up to 3 metres, with diverse machining and drilling. The opening can have either a circular, oval, square or rectangular section which can be made on the side or on the corner, in order to satisfy any aesthetic requirement.

Le barre forate e barre sagomate Arteferro sono degli elementi simbolo del ferro battuto. Al di là della funzione protettiva, conferiscono un tocco di eleganza che impreziosisce l'edificio in cui sono installate. Le barre forate Arteferro sono disponibili con lunghezze fino a 3 metri, con diverse lavorazioni e forature. L'apertura può avere sezione circolare, ovale, quadrata o rettangolare e può essere effettuata sia sul lato sia sullo spigolo, in modo da soddisfare ogni esigenza estetica.

# BARRE FORATE - BARRE SAGOMATE PIERCES BARS - SHAPED BARS

2. Pierced bars Shaped bars - Barre forate Barre sagomate

- A Round pierced bars Barre forate in tondo ..... pag.44
- B Square pierced bars Barre forate in quadro ..... pag.45
- C Flat punched bars Piatti forati ..... pag.48
- D Pierced tubes Tubi forati ..... pag.53
- E Pierced posts Montanti forati ..... pag.54
- F Bars with stamped rivets Barre con ribattini stampati ..... pag.56
- G Shaped bars Barre sagomate ..... pag.59

Select the section first, then the type of hole and technical details (section, hole size, pitch, distance, no. of holes) At this point, identifying the finish will be easy.

Scegli prima la sezione e poi il tipo di foro e i dettagli tecnici (sezione, dimensione foro, interasse, luce, n. fori) A questo punto, individuare la finitura sarà un gioco da ragazzi.



Choose the pierced bar, add "/ SAB" at the end of the code to order the sandblasted version or add "/ Z" to order the galvanized version

Scegli la barra forata, aggiungi "/ SAB" alla fine del codice per ordinare la versione sabbiata o aggiungi "/ Z" per ordinare la versione zincata a freddo

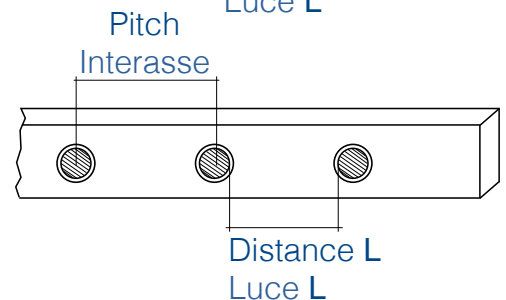
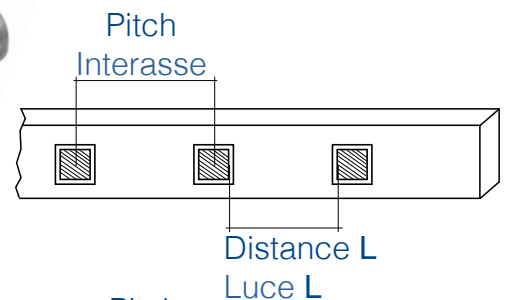

Example - Esempio

**1360/6/SAB** = sandblasted version = versione sabbiata

**1360/6/Z** = galvanized version = versione zincata a freddo

L 2.000 mm









Section Sezione	Hole Foro	Section Ø Ø Sezione	Hole for Foro per	Pitch Interasse	Distance Luce	N. Holes N. Fori	Plain Liscio	Bark effect Cortecchia
							Art.	Art.
Round hole Foro tondo		12 mm	12 mm	120 mm	108 mm	16	1360/6	-
		14 mm	14 mm	140 mm	126 mm	14	42/1 <b>BEST PRICE</b>	606/1
		14 mm	14 mm	124 mm	110 mm	14	42/A/1	-
		16 mm	16 mm	150 mm	134 mm	13	42/2	606/2
		16 mm	16 mm	126 mm	110 mm	14	42/A/2	-
		18 mm	18 mm	160 mm	142 mm	12	42/3	606/3
		18 mm	18 mm	128 mm	110 mm	14	42/A/3	-
		20 mm	20 mm	170 mm	150 mm	11	42/4	606/4
		20 mm	20 mm	130 mm	110 mm	14	42/A/4	-
		22 mm	22 mm	170 mm	148 mm	11	42/5	-
Oval hole Foro ovale		14 mm	28 x 14 mm	140 mm	126 mm	14	607/1	-
		16 mm	32 x 16 mm	150 mm	134 mm	13	607/2	-
		18 mm	34 x 18 mm	160 mm	142 mm	12	607/3	-
		20 mm	38 x 20 mm	170 mm	150 mm	11	607/4	-



Square pierced bars - Barre forate in quadro



L 2.000 mm

Section Sezione	Hole Foro	Section $\Phi$ Sezione $\Phi$	Hole for Foro per	Pitch Interasse	Distance Luce	N. Holes N. Fori	Plain Liscio	Bark effect Corteccia	Four-leaf clover Quadrifoglio	Beveled Smussato	Hammered Spigliato
 		12 mm	12 x 12 mm	120 mm	108 mm	16	Art.	Art.	Art.	Art.	Art.
		12 mm	12 x 12 mm	140 mm	-	14	1360/7	-	-	GD124/9	1360/1
		14 mm	14 x 14 mm	140 mm	126 mm	14	-	-	1361/5	-	-
		14 mm	14 x 14 mm	124 mm	110 mm	14	42/8	605/1	-	GD124/10	1360/2
		14 mm	14 x 14 mm	150 mm	-	13	42/A/5	-	1361/6	-	-
		15 mm	15 x 15 mm	160 mm	-	12	-	-	1361/7	-	-
		16 mm	16 x 16 mm	150 mm	134 mm	13	-	-	-	-	-
		16 mm	16 x 16 mm	126 mm	110 mm	14	42/9	605/2	-	GD124/11	1360/3
		17 mm	17 x 17 mm	160 mm	-	11	42/A/6	-	-	-	-
		18 mm	18 x 18 mm	160 mm	142 mm	12	-	-	1361/8	-	-
		18 mm	18 x 18 mm	128 mm	110 mm	14	42/10	605/3	-	GD124/12	1360/4
		18 mm	12 x 12 mm	122 mm	110 mm	14	42/A/7	-	-	-	-
		18 mm	14 x 14 mm	124 mm	110 mm	14	42/A/17	-	-	-	-
		20 mm	20 x 20 mm	170 mm	150 mm	11	42/A/18	-	-	-	-
		20 mm	20 x 20 mm	130 mm	110 mm	14	42/11	605/4	-	GD124/13	1360/5
		22 mm	22 x 22 mm	170 mm	148 mm	11	42/A/8	-	-	-	-
		25 mm	25 x 25 mm	180 mm	165 mm	10	42/12	-	-	GD124/14	-
30 mm	30 x 30 mm	200 mm	190 mm	9	42/13	-	-	GD124/15	-		
 		12 mm	12 x 12 mm	140 mm	-	14	-	-	1361/1	-	-
		14 mm	14 x 14 mm	140 mm	-	14	42/14	-	-	GD124/16	607/4
		14 mm	14 x 14 mm	129,8 mm	110 mm	14	-	-	1361/1	-	-
		14 mm	14 x 14 mm	150 mm	-	13	42/22	605/5	-	-	-
		15 mm	15 x 15 mm	160 mm	-	12	42/A/13	-	-	-	-
		16 mm	16 x 16 mm	150 mm	-	13	-	-	1361/2	-	-
		16 mm	16 x 16 mm	132,6 mm	110 mm	14	-	-	1361/3	-	-
		17 mm	17 x 17 mm	170 mm	-	11	42/23	605/6	-	-	-
		18 mm	18 x 18 mm	160 mm	-	12	42/A/14	-	-	-	-
		18 mm	18 x 18 mm	135,5 mm	110 mm	14	-	-	1361/4	-	-
		18 mm	18 x 18 mm	125 mm	-	15	42/24	605/7	-	-	-
		20 mm	20 x 20 mm	170 mm	-	11	42/A/15	-	-	-	-
		20 mm	20 x 20 mm	138,3 mm	110 mm	14	42/A/15/S	-	-	-	-
		22 mm	22 x 22 mm	170 mm	-	11	42/25	605/8	-	-	-
		25 mm	25 x 25 mm	180 mm	-	10	42/A/16	-	-	-	-
		30 mm	30 x 30 mm	200 mm	-	9	42/A/16/SP3	-	-	-	-
		 		14 mm	14 x 14 mm	140 mm	-	14	42/26	-	-
14 mm	14 x 14 mm			129,8 mm	110 mm	14	42/27	-	-	-	-
16 mm	16 x 16 mm			150 mm	-	13	42/28	-	-	-	-
16 mm	16 x 16 mm			132,6 mm	110 mm	14	42/15	-	-	-	-
18 mm	18 x 18 mm			160 mm	-	12	42/A/9	-	-	-	-
18 mm	18 x 18 mm			135,5 mm	110 mm	14	42/16	-	-	-	-
20 mm	20 x 20 mm			170 mm	-	11	42/A/10	-	-	-	-
20 mm	20 x 20 mm			138,3 mm	110 mm	14	42/17	-	-	-	-
22 mm	22 x 22 mm			170 mm	-	11	42/A/11	-	-	-	-
25 mm	25 x 25 mm			180 mm	-	10	42/A/12	-	-	-	-
30 mm	30 x 30 mm			200 mm	-	9	42/19	-	-	-	-

Square hole on the side - Foro quadro su lato

Square hole on the side - Foro quadro su lato

Square hole on the edge - Foro quadro su spigolo

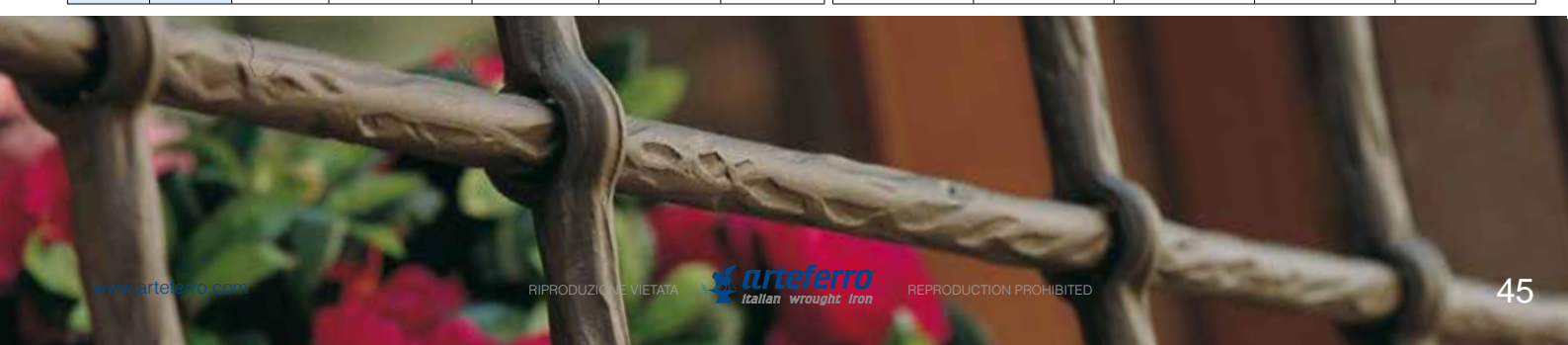

Square pierced bars - Barre forate in quadro



L 2.000 mm

	Section Sezione	Hole Foro	Section $\varnothing$ Sezione $\varnothing$	Hole for Foro per	Pitch Interasse	Distance Luce	N. Holes N. Fori	Plain Liscio	Beveled Smussato
								Art.	Art.
Oval hole on edge Foro ovale su spigolo			14 mm	18 x 15 mm	158 mm	140 mm	14	1845/16	-
			16 mm	32 x 17 mm	182 mm	150 mm	13	1845/17	-
			18 mm	34 x 19 mm	194 mm	160 mm	12	1845/18	-
			20 mm	38 x 21 mm	208 mm	170 mm	11	1845/19	-
square bar with rectangular hole barra quadrata con foro rett.			14 mm	24 x 15 mm	164 mm	140 mm	14	1845/20	-
			16 mm	30 x 17 mm	180 mm	150 mm	13	1845/21	-
			18 mm	31 x 19 mm	191 mm	160 mm	12	1845/22	-
square bar with round hole barra quadrata con foro tondo			14 mm	15 mm	155 mm	140 mm	14	1845/24	-
			16 mm	17 mm	167 mm	150 mm	13	1845/25	-
			18 mm	19 mm	179 mm	160 mm	12	1845/26	-
beveled bar with round hole barra smussata con foro tondo			12 mm	12 mm	120 mm	108 mm	16	-	GD124/1
			14 mm	14 mm	140 mm	126 mm	14	-	GD124/2
			16 mm	16 mm	150 mm	134 mm	13	-	GD124/3
			18 mm	18 mm	160 mm	142 mm	12	-	GD124/4
			20 mm	20 mm	170 mm	150 mm	11	-	GD124/5
			22 mm	22 mm	170 mm	148 mm	11	-	GD124/6
			25 mm	25 mm	180 mm	155 mm	10	-	GD124/7
30 mm	30 mm	200 mm	177 mm	9	-	GD124/8			



Arteferro products are available in raw metal as well as sandblasted or galvanized on request.

I prodotti Arteferro sono disponibili in metallo grezzo e, su richiesta, anche sabbiati o zincati a freddo.





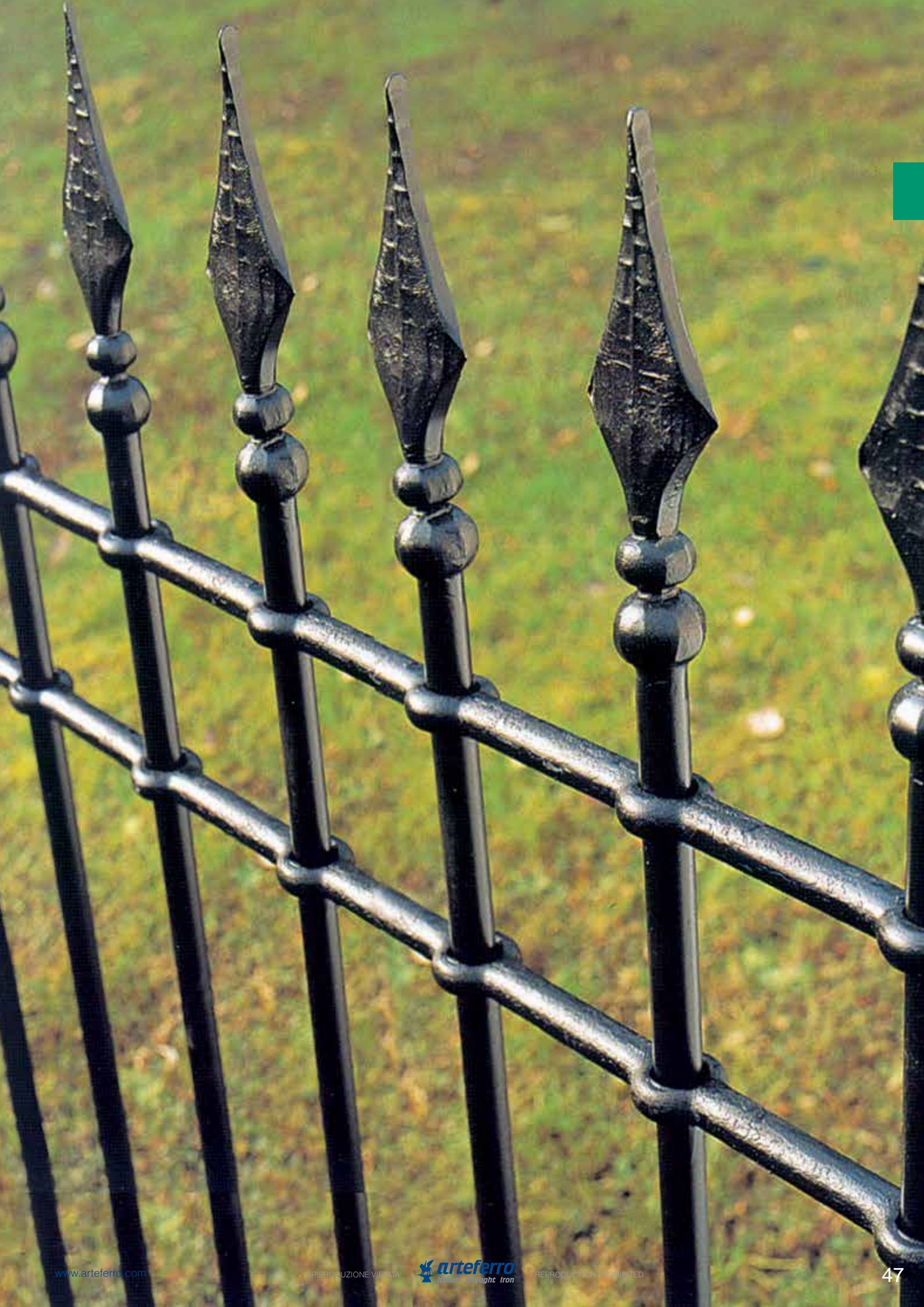

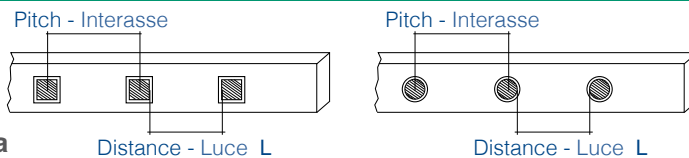

L 2.000 mm approx. - circa

Section Sezione	Hole Foro	Hole for Foro per	Pitch Interasse	Distance Luce	Hole N. N. Fori	Plain Liscio
						Art.
30 x 8 mm		12 mm	112 mm	100 mm	17	1853/105
			127 mm	115 mm	15	1853/106
			142 mm	130 mm	13	1853/107
		14 mm	114 mm	100 mm	16	1853/108
			129 mm	115 mm	14	1853/109
			144 mm	130 mm	13	1853/110
		16 mm	116 mm	100 mm	16	1853/111
			131 mm	115 mm	14	1853/112
			146 mm	130 mm	13	1853/113
30 x 10 mm		12 mm	112 mm	100 mm	17	1853/114
			127 mm	115 mm	15	1853/115
			142 mm	130 mm	13	1853/116
		14 mm	114 mm	100 mm	16	1853/117
			129 mm	115 mm	14	1853/118
			144 mm	130 mm	13	1853/119
		16 mm	116 mm	100 mm	16	1853/120
			131 mm	115 mm	14	1853/121
			146 mm	130 mm	13	1853/122
35 x 8 mm		12 mm	112 mm	100 mm	17	1853/123
			127 mm	115 mm	15	1853/124
			142 mm	130 mm	13	1853/125
		14 mm	114 mm	100 mm	16	1853/126
			129 mm	115 mm	14	1853/127
			144 mm	130 mm	13	1853/128
		16 mm	116 mm	100 mm	16	1853/129
			131 mm	115 mm	14	1853/130
			146 mm	130 mm	13	1853/131
35 x 10 mm		12 mm	112 mm	100 mm	17	1853/132
			127 mm	115 mm	15	1853/133
			142 mm	130 mm	13	1853/134
		14 mm	114 mm	100 mm	16	1853/135
			129 mm	115 mm	14	1853/136
			144 mm	130 mm	13	1853/137
		16 mm	116 mm	100 mm	16	1853/138
			131 mm	115 mm	14	1853/139
			146 mm	130 mm	13	1853/140
40 x 8 mm		12 mm	112 mm	100 mm	17	1853/141
			127 mm	115 mm	15	1853/142
			142 mm	130 mm	13	1853/143
		14 mm	114 mm	100 mm	16	1853/144
			129 mm	115 mm	14	1853/145
			144 mm	130 mm	13	1853/146
		16 mm	116 mm	100 mm	16	1853/147
			131 mm	115 mm	14	1853/148
			146 mm	130 mm	13	1853/149
40 x 10 mm		12 mm	112 mm	100 mm	17	1853/150
			127 mm	115 mm	15	1853/151
			142 mm	130 mm	13	1853/152
		14 mm	114 mm	100 mm	16	1853/153
			129 mm	115 mm	14	1853/154
			144 mm	130 mm	13	1853/155
		16 mm	116 mm	100 mm	16	1853/156
			131 mm	115 mm	14	1853/157
			146 mm	130 mm	13	1853/158



Choose the flat pierced bars, add "/ SAB" at the end of the code to order the sandblasted version or add "/ Z" to order the galvanized version

Scegli i piatti forati, aggiungi "/ SAB" alla fine del codice per ordinare la versione sabbiata o aggiungi "/ Z" per ordinare la versione zincata a freddo

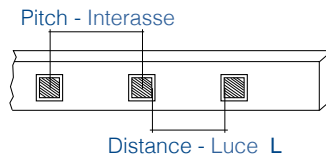

L 2.000 mm approx. - circa

Section Sezione	Hole Foro	Hole for Foro per	Pitch Interasse	Distance Luce	Hole N. N. Fori	Plain Liscio
						Art.
30 x 8 mm		12 x 12 mm	112 mm	100 mm	17	1853/1
			127 mm	115 mm	15	1853/2
			142 mm	130 mm	13	1853/3
		14 x 14 mm	114 mm	100 mm	16	608/6
			129 mm	115 mm	14	1853/4
			144 mm	130 mm	13	608/5
		16 x 16 mm	116 mm	100 mm	16	1853/5
			131 mm	115 mm	14	1853/6
			146 mm	130 mm	13	1853/7
30 x 10 mm		12 x 12 mm	112 mm	100 mm	17	1853/8
			127 mm	115 mm	15	1853/9
			142 mm	130 mm	13	1853/10
		14 x 14 mm	114 mm	100 mm	16	1853/11
			129 mm	115 mm	14	1853/12
			144 mm	130 mm	13	1853/13
		16 x 16 mm	116 mm	100 mm	16	1853/14
			131 mm	115 mm	14	1853/15
			146 mm	130 mm	13	1853/16
35 x 8 mm		12 x 12 mm	112 mm	100 mm	17	1853/17
			127 mm	115 mm	15	1853/18
			142 mm	130 mm	13	1853/19
		14 x 14 mm	114 mm	100 mm	16	1853/20
			129 mm	115 mm	14	1853/21
			144 mm	130 mm	13	1853/22
		16 x 16 mm	116 mm	100 mm	16	1853/23
			131 mm	115 mm	14	1853/24
			146 mm	130 mm	13	1853/25
35 x 10 mm		12 x 12 mm	112 mm	100 mm	17	1853/26
			127 mm	115 mm	15	1853/27
			142 mm	130 mm	13	1853/28
		14 x 14 mm	114 mm	100 mm	16	1853/29
			129 mm	115 mm	14	1853/30
			144 mm	130 mm	13	1853/31
		16 x 16 mm	116 mm	100 mm	16	1853/32
			131 mm	115 mm	14	1853/33
			146 mm	130 mm	13	1853/34
40 x 8 mm		12 x 12 mm	112 mm	100 mm	17	1853/35
			127 mm	115 mm	15	1853/36
			142 mm	130 mm	13	1853/37
		14 x 14 mm	114 mm	100 mm	16	608/8
			129 mm	115 mm	14	1853/38
			144 mm	130 mm	13	608/7
		16 x 16 mm	116 mm	100 mm	16	1853/39
			131 mm	115 mm	14	1853/40
			146 mm	130 mm	13	1853/41
40 x 10 mm		12 x 12 mm	112 mm	100 mm	17	1853/42
			127 mm	115 mm	15	1853/43
			142 mm	130 mm	13	1853/44
		14 x 14 mm	114 mm	100 mm	16	1853/45
			129 mm	115 mm	14	1853/46
			144 mm	130 mm	13	1853/47
		16 x 16 mm	116 mm	100 mm	16	1853/48
			131 mm	115 mm	14	1853/49
			146 mm	130 mm	13	1853/50



**i** The punched plates can also be made to measure up to 6 metres.

I piatti forati sono realizzabili anche su misura fino a 6 mt.

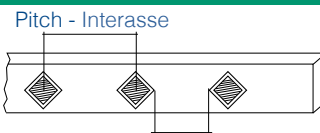

L 2.000 mm approx. - circa

Distance - Luce L

Section Sezione	Hole Foro	Hole for Foro per	Pitch Interasse	Distance Luce	Hole N. N. Fori	Plain Liscio
						Art.
30 x 8 mm		12 x 12 mm	117 mm	100 mm	16	1853/51
			132 mm	115 mm	14	1853/52
			147 mm	130 mm	13	1853/53
		14 x 14 mm	119,8 mm	100 mm	16	1853/54
			134,8 mm	115 mm	14	1853/55
			149,8 mm	130 mm	12	1853/56
		16 x 16 mm	122,6 mm	100 mm	16	1853/57
			137,6 mm	115 mm	14	1853/58
			152,6 mm	130 mm	12	1853/59
30 x 10 mm		12 x 12 mm	117 mm	100 mm	16	1853/60
			132 mm	115 mm	14	1853/61
			147 mm	130 mm	13	1853/62
		14 x 14 mm	119,8 mm	100 mm	16	1853/63
			134,8 mm	115 mm	14	1853/64
			149,8 mm	130 mm	12	1853/65
		16 x 16 mm	122,6 mm	100 mm	16	1853/66
			137,6 mm	115 mm	14	1853/67
			152,6 mm	130 mm	12	1853/68
35 x 8 mm		12 x 12 mm	117 mm	100 mm	16	1853/69
			132 mm	115 mm	14	1853/70
			147 mm	130 mm	13	1853/71
		14 x 14 mm	119,8 mm	100 mm	16	1853/72
			134,8 mm	115 mm	14	1853/73
			149,8 mm	130 mm	12	1853/74
		16 x 16 mm	122,6 mm	100 mm	16	1853/75
			137,6 mm	115 mm	14	1853/76
			152,6 mm	130 mm	12	1853/77
35 x 10 mm		12 x 12 mm	117 mm	100 mm	16	1853/78
			132 mm	115 mm	14	1853/79
			147 mm	130 mm	13	1853/80
		14 x 14 mm	119,8 mm	100 mm	16	1853/81
			134,8 mm	115 mm	14	1853/82
			149,8 mm	130 mm	12	1853/83
		16 x 16 mm	122,6 mm	100 mm	16	1853/84
			137,6 mm	115 mm	14	1853/85
			152,6 mm	130 mm	12	1853/86
40 x 8 mm		12 x 12 mm	117 mm	100 mm	16	1853/87
			132 mm	115 mm	14	1853/88
			147 mm	130 mm	13	1853/89
		14 x 14 mm	119,8 mm	100 mm	16	1853/90
			134,8 mm	115 mm	14	1853/91
			149,8 mm	130 mm	12	1853/92
		16 x 16 mm	122,6 mm	100 mm	16	1853/93
			137,6 mm	115 mm	14	1853/94
			152,6 mm	130 mm	12	1853/95
40 x 10 mm		12 x 12 mm	117 mm	100 mm	16	1853/96
			132 mm	115 mm	14	1853/97
			147 mm	130 mm	13	1853/98
		14 x 14 mm	119,8 mm	100 mm	16	1853/99
			134,8 mm	115 mm	14	1853/100
			149,8 mm	130 mm	12	1853/101
		16 x 16 mm	122,6 mm	100 mm	16	1853/102
			137,6 mm	115 mm	14	1853/103
			152,6 mm	130 mm	12	1853/104



The punched bars can also be made to measure up to 6 metres.

I piatti forati sono realizzabili anche su misura fino a 6 mt.

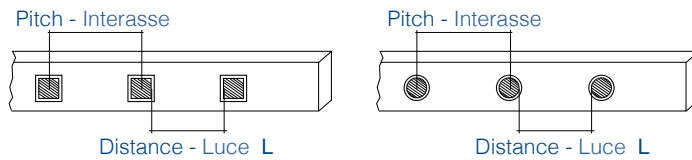

Flat punched bars - Piatti forati

L 2.000 mm approx. - circa

Section Sezione	Hole Foro	Hole for Foro per	Pitch Interasse	Distance Luce	Hole N. N. Fori	Hammered on 2 corners Spigolato su 2 angoli	Hammered on 4 edges and 2 sides Battuto 4 spigoli e 2 lati
						Art.	Art.
30 x 8 mm		12 x 12 mm	112 mm	100 mm	17	1853/159	1853/195
			127 mm	115 mm	15	1853/160	1853/196
			142 mm	130 mm	13	1853/161	1853/197
		14 x 14 mm	114 mm	100 mm	16	1853/162	1853/198
			129 mm	115 mm	14	1853/163	1853/199
			147 mm	130 mm	13	1853/164	609/2
		16 x 16 mm	116 mm	100 mm	16	1853/165	1853/201
			131 mm	115 mm	14	1853/166	1853/202
			146 mm	130 mm	13	1853/167	1853/203
40 x 8 mm		12 x 12 mm	112 mm	100 mm	17	1853/168	1853/204
			127 mm	115 mm	15	1853/169	1853/205
			142 mm	130 mm	13	1853/170	1853/206
		14 x 14 mm	114 mm	100 mm	16	1853/171	1853/207
			129 mm	115 mm	14	1853/172	1853/208
			147 mm	130 mm	13	1853/173	1853/209
		16 x 16 mm	116 mm	100 mm	16	1853/174	1853/210
			131 mm	115 mm	14	1853/175	1853/211
			146 mm	130 mm	13	1853/176	1853/212
30 x 8 mm		12 mm	112 mm	100 mm	17	1853/177	1853/213
			127 mm	115 mm	15	1853/178	1853/214
			142 mm	130 mm	13	1853/179	1853/215
		14 mm	114 mm	100 mm	16	1853/180	1853/216
			129 mm	115 mm	14	1853/181	1853/217
			147 mm	130 mm	13	1853/182	1853/218
		16 mm	116 mm	100 mm	16	1853/183	1853/219
			131 mm	115 mm	14	1853/184	1853/220
			146 mm	130 mm	13	1853/185	1853/221
40 x 8 mm		12 mm	112 mm	100 mm	17	1853/186	1853/222
			127 mm	115 mm	15	1853/187	1853/223
			142 mm	130 mm	13	1853/188	1853/224
		14 mm	114 mm	100 mm	16	1853/189	1853/225
			129 mm	115 mm	14	1853/190	1853/226
			147 mm	130 mm	13	1853/191	1853/227
		16 mm	116 mm	100 mm	16	1853/192	1853/228
			131 mm	115 mm	14	1853/193	1853/229
			146 mm	130 mm	13	1853/194	1853/230



## HOT PIERCED - FORATI A CALDO

L 2.000 mm approx. - circa

Section  Sezione 	Hole Foro	Hole for Foro per	Pitch Interasse	Distance Luce	Hole N. N. Fori	Plain Liscio
						Art.
30 x 15 mm		18 x 18 mm	140 mm	122 mm	13	1360/10
30 x 20 mm		18 x 18 mm	140 mm	122 mm	13	1360/11



Choose the flat pierced bars, add "/ SAB" at the end of the code to order the sandblasted version or add "/ Z" to order the galvanized version

Scegli i piatti forati, aggiungi "/ SAB" alla fine del codice per ordinare la versione sabbiata o aggiungi "/ Z" per ordinare la versione zincata a freddo

## HOT PIERCED - FORATI A CALDO

L 2.000 mm approx. - circa

Section  Sezione 	Hole Foro	Hole for Foro per	Pitch Interasse	Distance Luce	Hole N. N. Fori	Plain Liscio
						Art.
30 x 15 mm		20 mm	140 mm	120 mm	14	1360/8
30 x 20 mm		20 mm	140 mm	120 mm	14	1360/9





51.000 km

of pierced bars have been manufactured by our factories to date. The circumference of the Earth is "only" 40,075 km

di barre forate sono state prodotte fino ad oggi nei nostri stabilimenti. La circonferenza della Terra è di "soli" 40.075 km

## COLD PUNCHED - FORATI A FREDDO

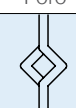
Section  Sezione 	Hole Foro	Hole for Foro per	Pitch Interasse	Distance Luce	Hole N. N. Fori	Plain Liscio	Length Lunghezza
						Art.	
40 x 8 mm		14 x 14 mm	140	120 mm	14	1360/12	2070 mm
40 x 8 mm		16 x 16 mm	143	120 mm	14	1360/13	2110 mm

Handrail - Corrimano  
Art.114/10/S

Section - Sezione	For hole - Per Foro	Pitch - Interasse	Holes Nr. - N. Fori	Art.
30 x 20 x 2 mm	Ø 12 mm	125 mm	23	1852/42
30 x 20 x 2 mm	Ø 14 mm	125 mm	23	1852/49
30 x 20 x 2 mm	□ 12 mm	125 mm	23	1852/44
30 x 20 x 2 mm	□ 14 mm	125 mm	23	1852/50
40 x 20 x 2 mm	Ø 12 mm	125 mm	23	1852/57
40 x 20 x 2 mm	Ø 14 mm	125 mm	23	1852/58
40 x 20 x 2 mm	Ø 16 mm	125 mm	23	1852/59
40 x 20 x 2 mm	□ 12 mm	125 mm	23	1852/60
40 x 20 x 2 mm	□ 14 mm	125 mm	23	1852/61
40 x 20 x 2 mm	□ 16 mm	125 mm	23	1852/62
50 x 25 x 2 mm	Ø 12 mm	125 mm	23	1852/81
50 x 25 x 2 mm	Ø 14 mm	125 mm	23	1852/82
50 x 25 x 2 mm	Ø 16 mm	125 mm	23	1852/83
50 x 25 x 2 mm	□ 12 mm	125 mm	23	1852/84
50 x 25 x 2 mm	□ 14 mm	125 mm	23	1852/85
50 x 25 x 2 mm	□ 16 mm	125 mm	23	1852/86

Punched tubes - Tubi forati

L 3.000 mm approx. - circa



**NEW** Plain - Liscio  
Plain tube with through holes  
Tubo liscio con fori passanti

L 3.000 mm approx. - circa

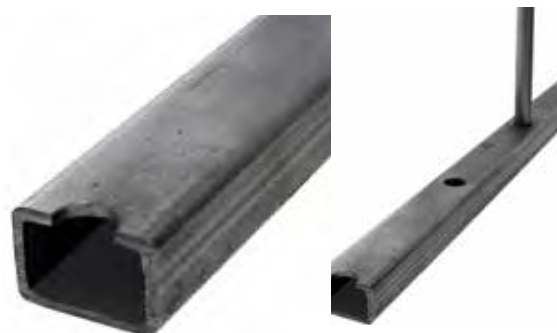

**NEW** Plain - Liscio  
Plain tube with blind holes  
Tubo liscio con fori ciechi

L 3.000 mm approx. - circa



**NEW** Hammered on the edges - Battuto sugli spigoli  
Hammered tube with through holes  
Long hammering  
Tubo spigolato con fori passanti  
Spigolatura allungata

L 3.000 mm approx. - circa



**NEW** Hammered on the edges - Battuto sugli spigoli  
Hammered tube with blind holes Long hammering  
Tubo spigolato con fori ciechi Spigolatura allungata

Section - Sezione	For hole - Per Foro	Pitch - Interasse	Holes Nr. - N. Fori	Art.
30 x 20 x 2 mm	Ø 12 mm	125 mm	23	1852/41
30 x 20 x 2 mm	Ø 14 mm	125 mm	23	1852/51
30 x 20 x 2 mm	□ 12 mm	125 mm	23	1852/43
30 x 20 x 2 mm	□ 14 mm	125 mm	23	1852/52
40 x 20 x 2 mm	Ø 12 mm	125 mm	23	1852/63
40 x 20 x 2 mm	Ø 14 mm	125 mm	23	1852/64
40 x 20 x 2 mm	Ø 16 mm	125 mm	23	1852/65
40 x 20 x 2 mm	□ 12 mm	125 mm	23	1852/66
40 x 20 x 2 mm	□ 14 mm	125 mm	23	1852/67
40 x 20 x 2 mm	□ 16 mm	125 mm	23	1852/68
50 x 25 x 2 mm	Ø 12 mm	125 mm	23	1852/87
50 x 25 x 2 mm	Ø 14 mm	125 mm	23	1852/88
50 x 25 x 2 mm	Ø 16 mm	125 mm	23	1852/89
50 x 25 x 2 mm	□ 12 mm	125 mm	23	1852/90
50 x 25 x 2 mm	□ 14 mm	125 mm	23	1852/91
50 x 25 x 2 mm	□ 16 mm	125 mm	23	1852/92

Section - Sezione	For hole - Per Foro	Pitch - Interasse	Holes Nr. - N. Fori	Art.
30 x 20 x 2 mm	Ø 12 mm	125 mm	23	1852/46
30 x 20 x 2 mm	Ø 14 mm	125 mm	23	1852/53
30 x 20 x 2 mm	□ 12 mm	125 mm	23	1852/48
30 x 20 x 2 mm	□ 14 mm	125 mm	23	1852/54
40 x 20 x 2 mm	Ø 12 mm	125 mm	23	1852/69
40 x 20 x 2 mm	Ø 14 mm	125 mm	23	1852/70
40 x 20 x 2 mm	Ø 16 mm	125 mm	23	1852/71
40 x 20 x 2 mm	□ 12 mm	125 mm	23	1852/72
40 x 20 x 2 mm	□ 14 mm	125 mm	23	1852/73
40 x 20 x 2 mm	□ 16 mm	125 mm	23	1852/74
50 x 25 x 2 mm	Ø 12 mm	125 mm	23	1852/93
50 x 25 x 2 mm	Ø 14 mm	125 mm	23	1852/94
50 x 25 x 2 mm	Ø 16 mm	125 mm	23	1852/95
50 x 25 x 2 mm	□ 12 mm	125 mm	23	1852/96
50 x 25 x 2 mm	□ 14 mm	125 mm	23	1852/97
50 x 25 x 2 mm	□ 16 mm	125 mm	23	1852/98

Section - Sezione	For hole - Per Foro	Pitch - Interasse	Holes Nr. - N. Fori	Art.
30 x 20 x 2 mm	Ø 12 mm	125 mm	23	1852/45
30 x 20 x 2 mm	Ø 14 mm	125 mm	23	1852/55
30 x 20 x 2 mm	□ 12 mm	125 mm	23	1852/47
30 x 20 x 2 mm	□ 14 mm	125 mm	23	1852/56
40 x 20 x 2 mm	Ø 12 mm	125 mm	23	1852/75
40 x 20 x 2 mm	Ø 14 mm	125 mm	23	1852/76
40 x 20 x 2 mm	Ø 16 mm	125 mm	23	1852/77
40 x 20 x 2 mm	□ 12 mm	125 mm	23	1852/78
40 x 20 x 2 mm	□ 14 mm	125 mm	23	1852/79
40 x 20 x 2 mm	□ 16 mm	125 mm	23	1852/80
50 x 25 x 2 mm	Ø 12 mm	125 mm	23	1852/99
50 x 25 x 2 mm	Ø 14 mm	125 mm	23	1852/100
50 x 25 x 2 mm	Ø 16 mm	125 mm	23	1852/101
50 x 25 x 2 mm	□ 12 mm	125 mm	23	1852/102
50 x 25 x 2 mm	□ 14 mm	125 mm	23	1852/103
50 x 25 x 2 mm	□ 16 mm	125 mm	23	1852/104

● Holes for - Fori per Ø 30 mm



Round hole  
Foro tondo

Art. 200/3  
□ 30 x 30 mm  
H 1200 mm

Round hole  
Foro tondo

Art. 200/12  
□ 30 x 30 mm  
H 1200 mm

Round hole  
Foro tondo

Art. 200/14  
□ 30 x 30 mm  
H 1200 mm

Round hole  
Foro tondo

Art. 200/16  
□ 30 x 30 mm  
H 1200 mm

Round hole  
Foro tondo

Art. 200/9  
□ 30 x 30 mm  
H 1100 mm

Round hole  
Foro tondo

Art. 200/5  
Ø 30 mm  
H 1200 mm

Round hole  
Foro tondo

Art. 200/18  
Ø 30 mm  
H 1200 mm



Choose the item, add "/ SAB" at the end of the code to order the sandblasted version or add "/ Z" to order the galvanized version

Scegli l'articolo aggiungi "/ SAB" alla fine del codice per ordinare la versione sabbata o aggiungi "/ Z" per ordinare la versione zincata a freddo





- upper hole for Ø 25 mm  
foro superiore per Ø 25 mm
- lower holes for Ø 22 mm  
fori inferiori per Ø 22 mm

- upper hole for Ø 30 mm  
foro superiore per Ø 30 mm
- lower holes for Ø 25 mm  
fori inferiori per Ø 25 mm

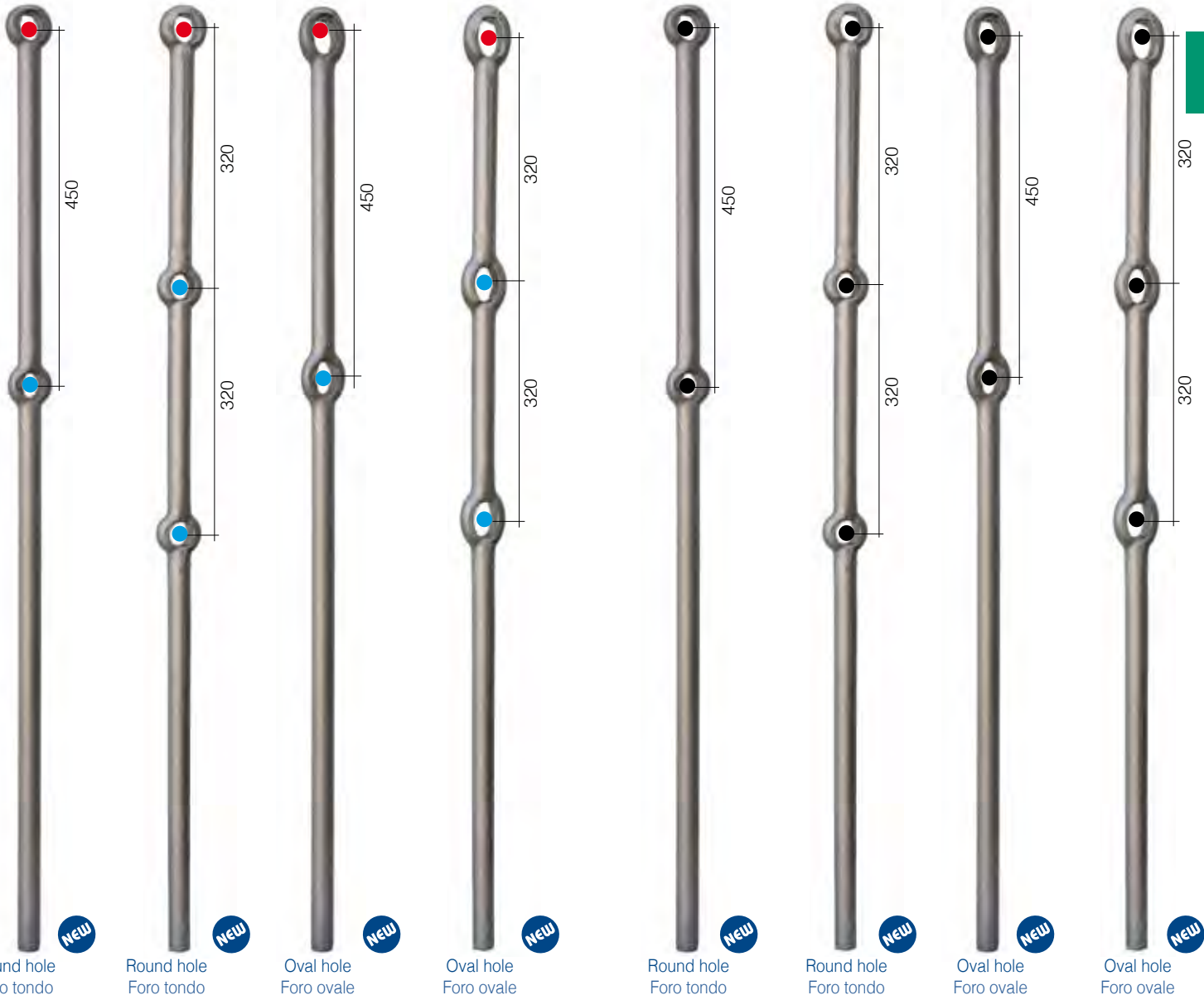

Round hole Foro tondo	Round hole Foro tondo	Oval hole Foro ovale	Oval hole Foro ovale	Round hole Foro tondo	Round hole Foro tondo	Oval hole Foro ovale	Oval hole Foro ovale
Art. 200/5/S28	Art. 200/18/S12	Art. 200/5/S44	Art. 200/18/S14	Art. 200/5/S45	Art. 200/18/S13	Art. 200/5/S46	Art. 200/18/S24
Ø 25 mm	Ø 25 mm	Ø 25 mm	Ø 25 mm	Ø 30 mm	Ø 30 mm	Ø 30 mm	Ø 30 mm
H 1200 mm	H 1200 mm	H 1200 mm	H 1200 mm	H 1200 mm	H 1200 mm	H 1200 mm	H 1200 mm

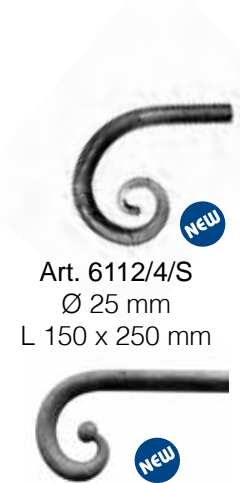

Art. 6112/4/S  
Ø 25 mm  
L 150 x 250 mm

Art. 596/4/S3  
Ø 25 mm  
L 150 x H 300 mm



Art. 595/7/S  
Ø 20 mm  
H 150 mm

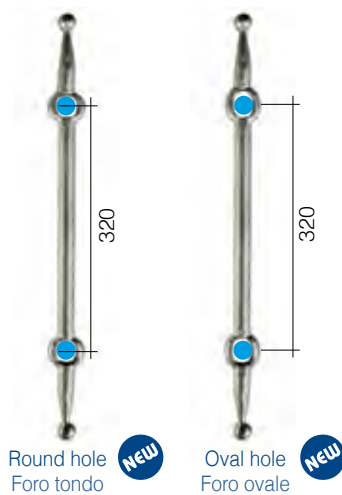

Art. 42/B/4/S16  
Ø 22 mm  
H 540 mm

Art. 42/B/4/S17  
Ø 22 mm  
H 540 mm

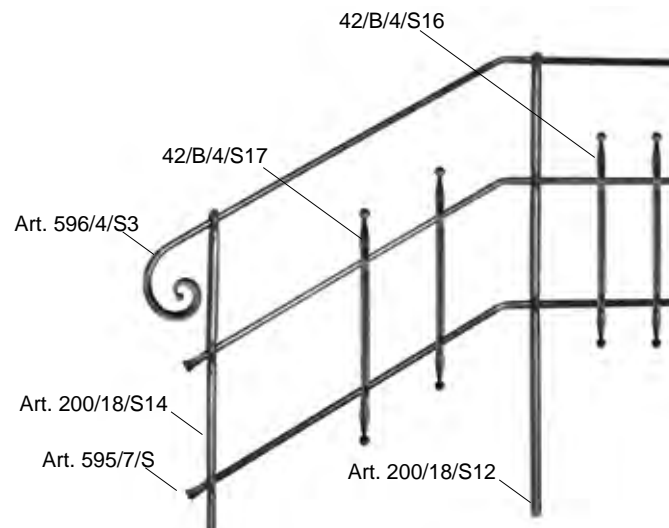

REPRODUCTION PROHIBITED

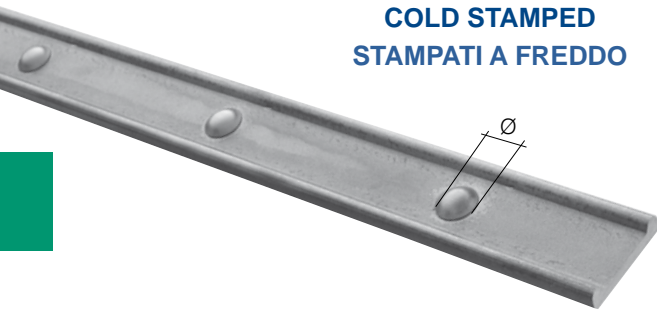
**COLD STAMPED  
STAMPATI A FREDDO****HOT ROLLED PROFILES  
PROFILI LISCI LAMINATI A CALDO**

Section - Sezione	Art.	Length - Lunghezza
	25 x 8 mm	158/49
		158/52
	30 x 8 mm	158/50
		158/53
	40 x 8 mm	158/51
		158/54

**L 2.000 mm approx. - circa**

Section  / Sezione	Rivet Ribattino	Pitch - Interasse 112 mm	Pitch - Interasse 122 mm	Pitch - Interasse 127 mm	Pitch - Interasse 132 mm
		Art.	Art.	Art.	Art.
30 x 8 mm	Ø 11 mm	1852/1	1852/2	1852/3	1852/4
40 x 8 mm	Ø 16 mm	1852/5	1852/6	1852/7	1852/8

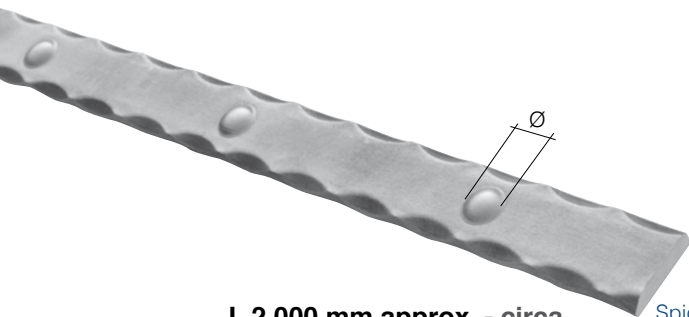
**L 2.000 mm approx. - circa**

Spigolato su 2 angoli - Hammered on 2 corners

Section  / Sezione	Rivet Ribattino	Pitch - Interasse 112 mm	Pitch - Interasse 122 mm	Pitch - Interasse 127 mm	Pitch - Interasse 132 mm
		Art.	Art.	Art.	Art.
25 x 6 mm	Ø 16 mm	1852/9	1852/10	1852/11	1852/12
25 x 8 mm	Ø 16 mm	1852/13	1852/14	1852/15	1852/16
30 x 6 mm	Ø 16 mm	1852/17	1852/18	1852/19	1852/20
30 x 8 mm	Ø 16 mm	1852/21	1852/22	1852/23	1852/24

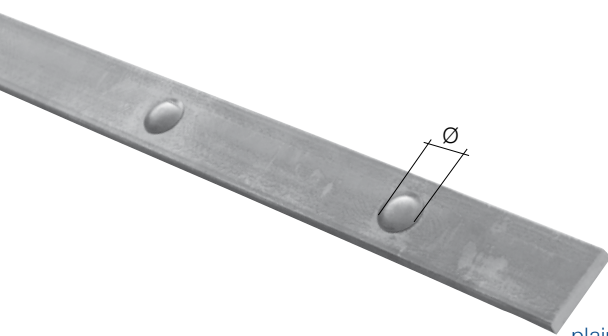

plain - liscio

**L 2.000 mm approx. - circa**

Section  / Sezione	Rivet Ribattino	Pitch - Interasse 112 mm	Pitch - Interasse 122 mm	Pitch - Interasse 127 mm	Pitch - Interasse 132 mm
		Art.	Art.	Art.	Art.
25 x 6 mm	Ø 16 mm	1852/25	1852/26	1852/27	1852/28
25 x 8 mm	Ø 16 mm	1852/29	1852/30	1852/31	1852/32
30 x 6 mm	Ø 16 mm	1852/33	1852/34	1852/35	1852/36
30 x 8 mm	Ø 16 mm	1852/37	1852/38	1852/39	1852/40

Art. 118/2  
for-per 614/5 - 614/6  
Φ 14 x 14 mm  
L 3000 mm



**HOT STAMPED  
STAMPATI A CALDO**

Art. 614/4   
Φ 14 x 14 mm  
pitch-interasse 125 mm  
L 2.000 mm  
n. 15 bushes-borchie



plain - liscio

Art. 614/5  
Φ 14 x 14 mm  
pitch-interasse 125 mm  
L 2.000 mm  
n. 15 bushes-borchie



hammered - spigolato

Art. 614/6  
Φ 14 x 14 mm  
pitch-interasse 125 mm  
L 2.000 mm  
n. 15 bushes-borchie



hammered - spigolato



Pag. 20

In section 1  
Long bars you'll  
find the profiles  
to match  
Nel capitolo 1  
Barre lunghe  
troverai i profili  
da abbinare

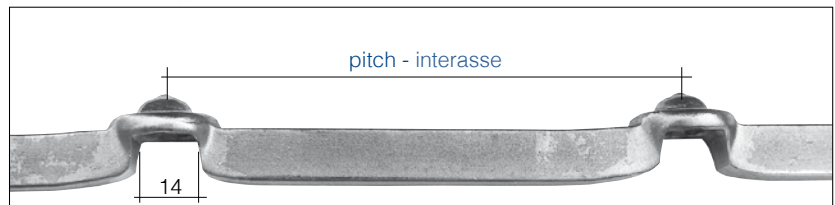



Art. 40/B/10  
 ▣ 20 x 6 mm

Art. 40/B/10/S1  
 ▣ 25 x 6 mm

L 2.000 mm - pitch - interasse 180 mm  
 holes - fori Ø 8,5 mm

pitch - interasse

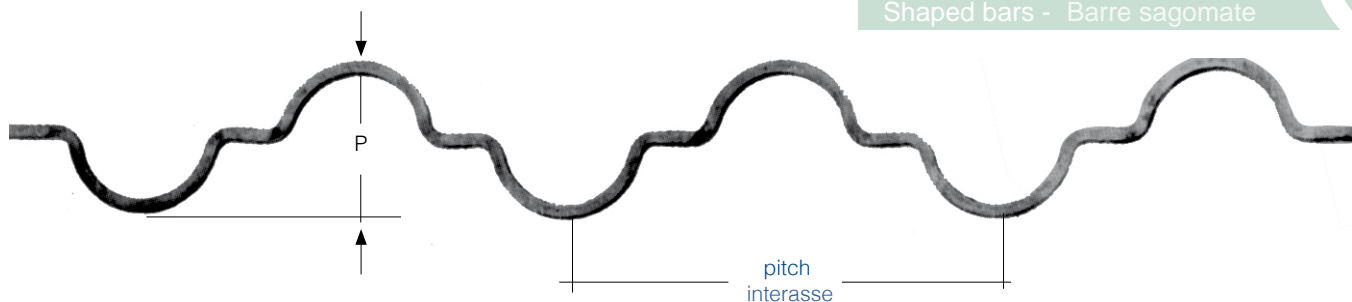

 Plain Liscio	Section - Sezione	Art.	Pitch - Interasse	P	Length - Lunghezza
	$\square$ 8 x 8 mm	38/1	240 mm	84 mm	1600 mm
$\square$ 12 x 6 mm	38/2	240 mm	80 mm	1600 mm	
$\square$ 10 x 10 mm	38/3	250 mm	95 mm	1600 mm	
$\square$ 12 x 12 mm	38/4	260 mm	100 mm	1600 mm	
$\varnothing$ 10 mm	1846/1	180 mm	100 mm	2000 mm	

 Hammered Spigolato	$\square$ 12 x 12 mm	621/1	260 mm	100 mm	1600 mm
--	----------------------	-------	--------	--------	---------

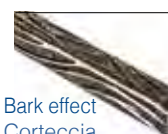
 Bark effect Corteccia	$\square$ 12 x 12 mm	1358/1	260 mm	100 mm	1600 mm
---	----------------------	--------	--------	--------	---------

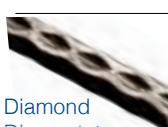
 Diamond Diamantato	$\square$ 12 x 12 mm	1358/2	260 mm	100 mm	1600 mm
---	----------------------	--------	--------	--------	---------

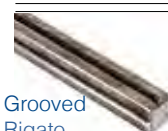
 Grooved Rigato	$\square$ 12 x 12 mm	620/1	260 mm	100 mm	1600 mm
--	----------------------	-------	--------	--------	---------

L 6000 mm - pitch - interasse 178 mm



Stamped on the corners  
Stampate sullo spigolo

Art. 40/1  
 $\square$  14 x 14 mm

Art. 40/2  
 $\square$  12 x 12 mm

Art. 40/3  
 $\square$  10 x 10 mm

Art. 40/4  
 $\square$  8 x 8 mm

Art. 40/5  
 $\varnothing$  12 mm



Art. 40/A/1  
 $\square$  12 x 12 mm

L 6000 mm - pitch - interasse 140 mm

Stamped on the side  
 Stampate sul lato

Art. 40/A/1/S  
 $\square$  14 x 14 mm

L 6000 mm - pitch - interasse 140 mm

Stamped on the side  
 Stampate sul lato



Art. 40/A/2  
 $\square$  12 x 12 mm

L 6000 mm - pitch - interasse 300 mm

Stamped on the side  
 Stampate sul lato



Art. 40/A/3  
 $\square$  12 x 12 mm

L 6000 mm - pitch - interasse 200 mm

Stamped on the side  
 Stampate sul lato



IAM Design General Catalogue Vol.18  
updated contents, renewed graphics  
and new in-depth information about the entire range  
of IAM Design products.

Catalogo generale IAM Design Vol.18  
contenuti aggiornati, grafica rinnovata e nuovi  
approfondimenti su tutta la linea di prodotti IAM Design.



Download the digital version from - Scarica la versione digitale da  
[www.iamdesign.com/download](http://www.iamdesign.com/download)

IAM Design - examples of applications, this is the catalogue of application solutions dedicated to architects and designers. As always, the experts at IAM Design are available to provide a customized consultancy service, so they can collaborate step by step with all of the professional involved in implementing your projects.

IAM Design - esempi di applicazioni è il catalogo di soluzioni applicative dedicato ad architetti e progettisti. Come sempre, gli esperti di IAM Design sono a disposizione per fornire un servizio di consulenza su misura al fine di collaborare passo passo con ogni professionista alla realizzazione dei suoi progetti.



EXAMPLES  
OF APPLICATIONS

ESEMPI  
DI APPLICAZIONI

[www.iamdesign.com](http://www.iamdesign.com)



Arteferro overthrow are decorative elements that can be used as the crowning points of a fence, a gate, a door or a window. From the simplest to the most elaborate, every Arteferro overthrow is ready for installation and is an ideal solution for combining fast installation and aesthetic results.

Le cimase Arteferro sono elementi decorativi che possono fare da coronamento per una recinzione, un cancello, un portone o una finestra. Dalla più semplice alla più elaborata, ogni cimasa Arteferro è pronta per l'installazione e rappresenta la soluzione ideale per combinare rapidità di posa e risultato estetico.

OVERTHROWS

CIMASE





Rounded cut ends  
Estremità tranciate a rondella

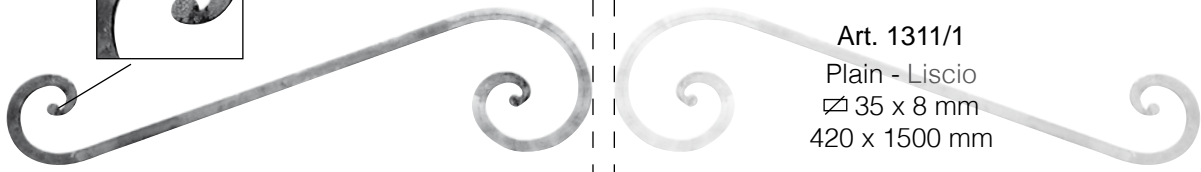

Art. 1311/1  
Plain - Liscio  
∅ 35 x 8 mm  
420 x 1500 mm



Art. 1311/2  
Plain - Liscio  
∅ 35 x 8 mm  
420 x 1500 mm

Rounded cut ends  
Estremità tranciate a rondella

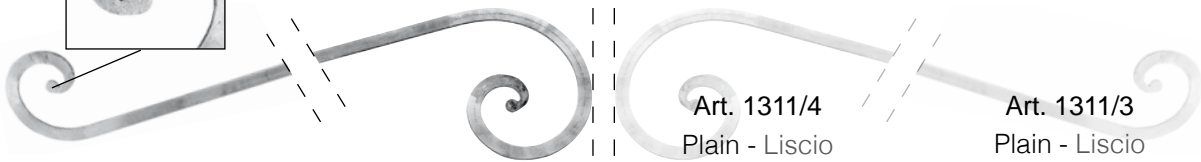

Art. 1311/4  
Plain - Liscio  
∅ 35 x 8 mm  
420 x 1000 mm

Art. 1311/3  
Plain - Liscio  
∅ 35 x 8 mm  
240 x 1000 mm

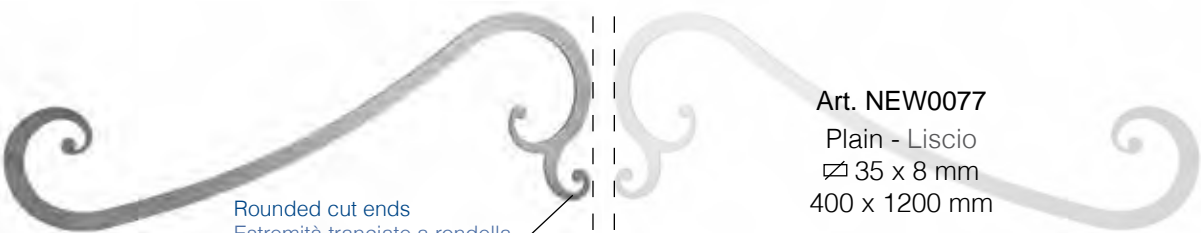

Rounded cut ends  
Estremità tranciate a rondella



Art. NEW0077  
Plain - Liscio  
∅ 35 x 8 mm  
400 x 1200 mm



Send us  
your own designs  
for your overthrows,  
and we'll do the rest  
for you!

Inviaci il disegno  
della tua cimasa,  
la faremo apposta  
per te!



Art. NEW0078  
Plain - Liscio  
∅ 35 x 8 mm  
570 x 2000 mm

Cut ends with dovetail  
Estremità tranciate  
a coda di rondine

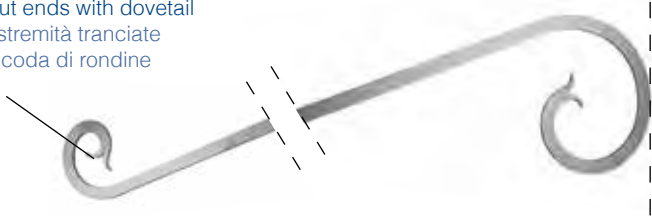

Art. NEW0080  
Plain - Liscio  
∅ 35 x 8 mm  
400 x 1300 mm

Art. NEW0079  
Plain - Liscio  
∅ 35 x 8 mm  
250 x 700 mm

X  
↓  
↑

Rounded cut ends  
Estremità tranciate a rondella



Art. NEW0081  
Plain - Liscio  
∅ 35 x 8 mm  
400 x 2100 mm  
X 130 mm

Art. NEW0082  
Plain - Liscio  
∅ 35 x 8 mm  
400 x 2000 mm

**A**

L 2000 mm  
H 500 mm

**B**

L 1200 mm  
H 250 mm



plain  
liscio

hammered on 4 corners  
spigolato 4 angoli

hammered on 4 corners and 2 sides  
magliato e spigolato su entrambi i lati



**A**

Art. 1827/5  
∅ 30 x 8 mm  
Art. 1827/6  
∅ 40 x 8 mm

**A**

Art. 1827/1  
∅ 30 x 8 mm  
Art. 1827/2  
∅ 40 x 8 mm

**A**

Art. 1827/3  
∅ 30 x 8 mm  
Art. 1827/4  
∅ 40 x 8 mm

**B**

Art. 1827/11  
∅ 30 x 8 mm  
Art. 1827/12  
∅ 40 x 8 mm

**B**

Art. 1827/7  
∅ 30 x 8 mm  
Art. 1827/8  
∅ 40 x 8 mm

**B**

Art. 1827/9  
∅ 30 x 8 mm  
Art. 1827/10  
∅ 40 x 8 mm



Art. 654/5  
 Ø 60 mm  
 6 mm

Ends welded on Art. 654/5  
 Estremità saldate su art. 654/5



Art. 653/1  
 30 x 8 mm  
 410 x 900 mm

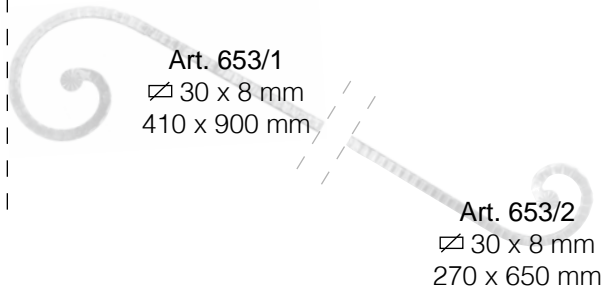

Art. 653/2  
 30 x 8 mm  
 270 x 650 mm

Art. 118/A/6  
 30 x 8 mm  
 L 3000 mm

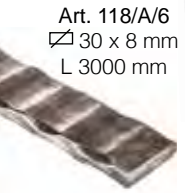

Art. 653/4  
 30 x 8 mm  
 360 x 1500 mm

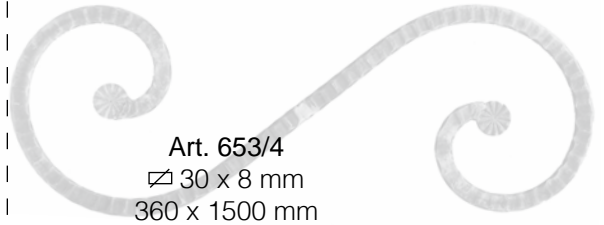

Hammered bar  
 on both sides  
 and corners  
 barra magliata  
 e spigolata su  
 entrambi i lati



Art. 653/3  
 30 x 8 mm  
 240 x 1500 mm

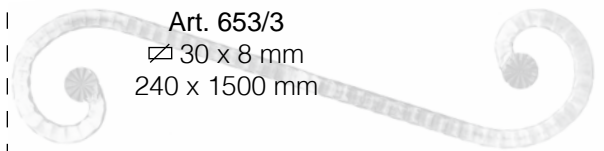

Art. 654/1  
 30 x 8 mm  
 370 x 1500 mm

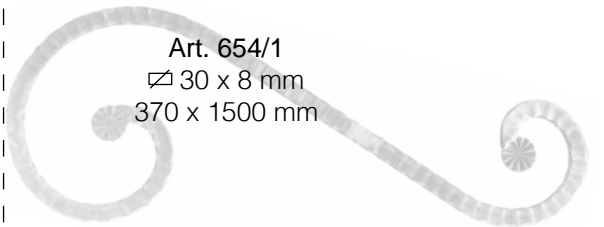

Ends welded on Art. 654/5  
Estremità saldate su art. 654/5



Art. 654/5  
Ø 60 mm  
6 mm



Art. 653/5  
30 x 8 mm  
310 x 1500 mm

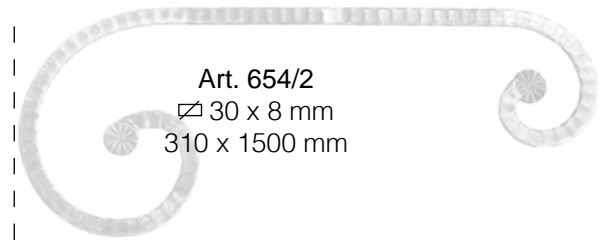

Art. 654/2  
30 x 8 mm  
310 x 1500 mm

Art. 118/A/6  
30 x 8 mm  
L 3000 mm

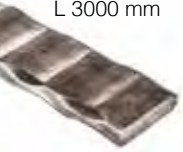

Hammered bar  
on both sides  
and corners  
barra magliata  
e spigolata su  
entrambi i lati

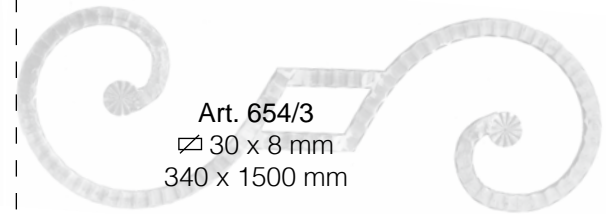

Art. 654/3  
30 x 8 mm  
340 x 1500 mm



Art. 654/4  
30 x 8 mm  
310 x 1500 mm

**i**

Pag.  
245

In section 17  
you'll find  
the accessories  
for the gates  
Nel capitolo 17  
troverai  
gli accessori  
per i cancelli





left - sinistro  
Art. GD285/2  
Ø 14 mm + 14 x 8 mm  
700 x 1360 mm



right - destro  
Art. GD285/2/S  
Ø 14 mm + 14 x 8 mm  
700 x 1360 mm



left - sinistro  
Art. 1281/11  
20 x 8 mm  
310 x 1100 mm



right - destro  
Art. 1281/12  
20 x 8 mm  
310 x 1100 mm



left - sinistro  
Art. 1281/5  
20 x 8 mm  
430 x 1230 mm



right - destro  
Art. 1281/6  
20 x 8 mm  
430 x 1230 mm



left - sinistro  
Art. 1281/7  
20 x 8 mm  
250 x 750 mm



right - destro  
Art. 1281/8  
20 x 8 mm  
250 x 750 mm



left - sinistro  
Art. 1281/9  
20 x 8 mm  
310 x 850 mm



right - destro  
Art. 1281/10  
20 x 8 mm  
310 x 850 mm



Art. 1369/2  
 16 x 8 mm  
 L 3000 mm

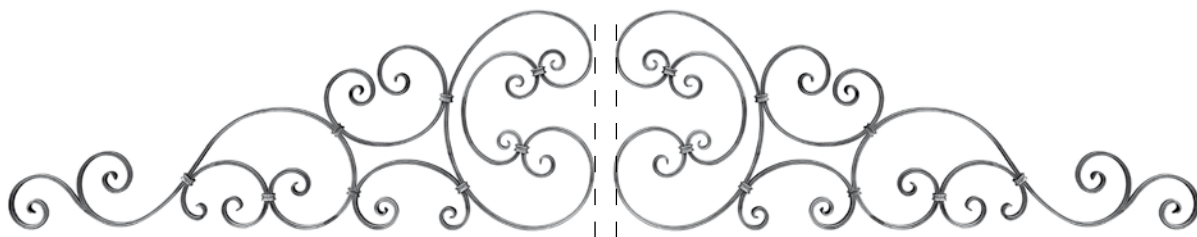

left - sinistro  
 Art. 1281/2/S2  
 16 x 8 mm  
 440 x 1260 mm



right - destro  
 Art. 1281/2  
 16 x 8 mm  
 440 x 1260 mm



Art. 1369/2  
 16 x 8 mm  
 L 3000 mm

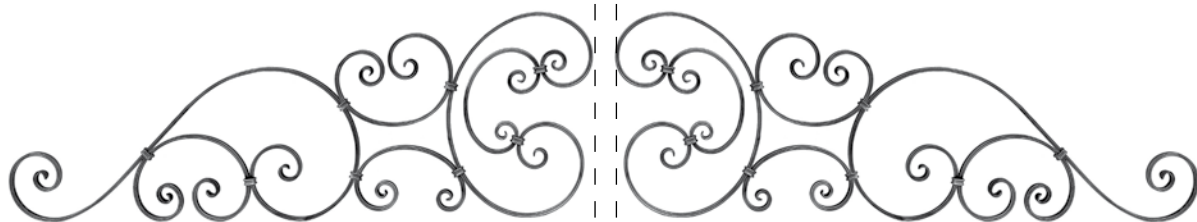

left - sinistro  
 Art. 1281/1/S  
 16 x 8 mm  
 445 x 1300 mm



right - destro  
 Art. 1281/1  
 16 x 8 mm  
 445 x 1300 mm



Art. 1369/2  
 16 x 8 mm  
 L 3000 mm

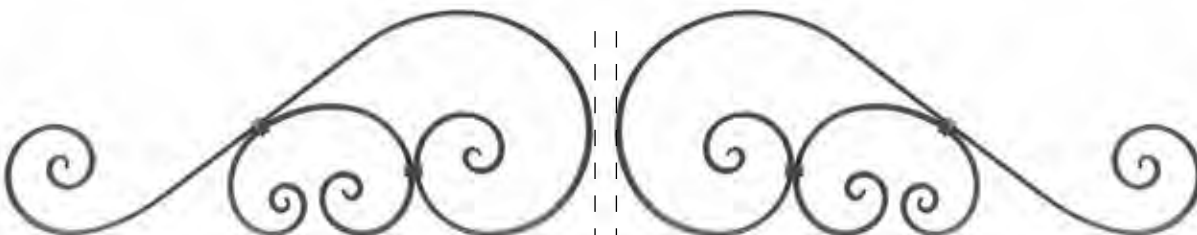

left - sinistro  
 Art. 1281/3/S  
 16 x 8 mm  
 340 x 830 mm

right - destro  
 Art. 1281/3  
 16 x 8 mm  
 340 x 830 mm



Art. 1369/2  
 16 x 8 mm  
 L 3000 mm

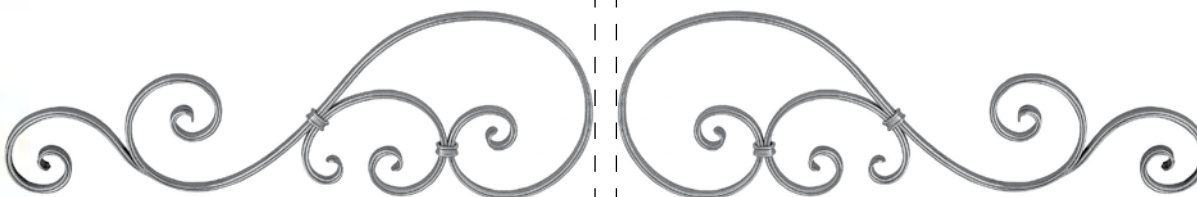

left - sinistro  
 Art. 1281/4/S2  
 16 x 8 mm  
 260 x 760 mm

right - destro  
 Art. 1281/4  
 16 x 8 mm  
 260 x 760 mm





Art. 1279/4  
 ∅ 20 x 6 mm  
 235 x 720 mm

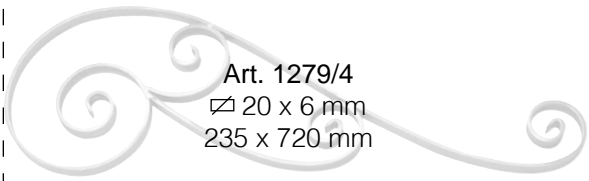

Art. 1279/3  
 ∅ 20 x 6 mm  
 190 x 450 mm

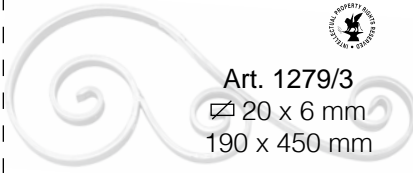

Art. 116/D/1  
 ∅ 20 x 6 mm  
 450 x 1280 mm

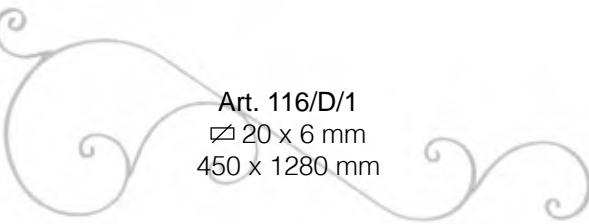

Hammered  
 Martellato  
 118/12  
 ∅ 20 x 6 mm



with leaves - con foglie  
 art. 136/3 and/e 136/4

Art. 116/D/2  
 ∅ 20 x 6 mm  
 450 x 1280 mm

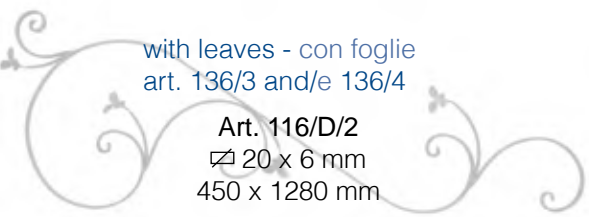

Hammered  
 Martellato  
 118/12  
 ∅ 20 x 6 mm



Art. 116/E/6  
 ∅ 30 x 8 mm  
 280 x 810 mm

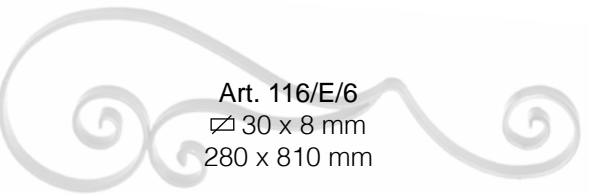

Not all of the Arteferro items are available in **Arteferro Quick**, just a special selection.

Find out about the entire range in the catalogue

In **Arteferro Quick** non sono presenti tutti gli articoli Arteferro, ma solo una speciale selezione. Scopri la gamma completa nel catalogo

*Compendium*



We also produce customised overthrows

Facciamo anche cimase su misura



Art. 1281/14  
 □ 20 x 8 mm  
 240 x 800 mm



Art. 116/E/2  
 □ 12 x 6 mm  
 240 x 1030 mm



Art. GD271/1  
 □ 16 x 6 mm  
 200 x 770 mm



Art. 116/E/3  
 □ 20 x 8 mm  
 300 x 800 mm



Art. GD271/2  
 □ 16 x 6 mm  
 220 x 830 mm



Art. 116/E/4  
 □ 12 x 6 mm  
 200 x 700 mm



Art. GD271/3  
 □ 16 x 6 mm  
 320 x 1100 mm



Art. 116/E/1  
 □ 20 x 8 mm  
 350 x 1000 mm



Art. 696/1  
 □ 16 x 8 mm  
 280 x 920 mm



Art. 1281/13  
 □ 20 x 8 mm  
 290 x 980 mm





Arteferro pickets and panels are amongst the most important items in the composition of an infill of a balustrade or fence. The classic design means you can create structures with a refined taste and an unmistakable and timeless style, typical of traditional wrought iron items.

I paletti e pannelli Arteferro sono tra gli elementi più importanti nella composizione del tamponamento di un parapetto o di una recinzione. Il design classico consente di realizzare strutture dal gusto ricercato e dallo stile inconfondibile ed intramontabile, tipico dei manufatti in ferro battuto tradizionali.

# PALETTI E PANNELLI CLASSICI CLASSICAL PICKETS AND PANELS

4.

Classical Pickets and Panels  
Paletti e Pannelli classici

A Forged pickets	Paletti forgiati	..... pag.72
B Stamped pickets	Paletti conati	..... pag.80
C Tube pickets	Paletti in tubo	..... pag.92
D Pickets with twisting	Paletti con torciglione	..... pag.94
E Pickets with big twisting	Paletti con torciglione grande	..... pag.100
F Pickets with baskets	Paletti con pigna	..... pag.102
G "S" shaped panels	Pannelli ad "esse"	..... pag.105
H Panels with scrolls	Pannelli con ricci	..... pag.110



A lot of pickets and panels have been classified to make it easier for you to find what you want quickly and easily. Starting with the central motif, you can find your article by process as well as matching decorations.

Molti paletti e pannelli sono stati classificati per dare la possibilità di trovare in modo veloce e pratico l'articolo desiderato. Parti dal motivo centrale troverai il tuo articolo con la lavorazione e i decori abbinabili.



Not all of the Arterferro items are available in **Arterferro Quick**, just a special selection. Find out about the entire range in the catalogue

In **Arterferro Quick** non sono presenti tutti gli articoli Arterferro, ma solo una speciale selezione.

Scopri la gamma completa nel catalogo

*Compendium*

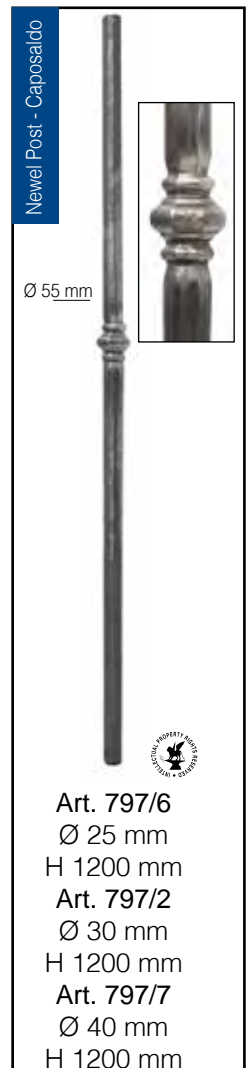
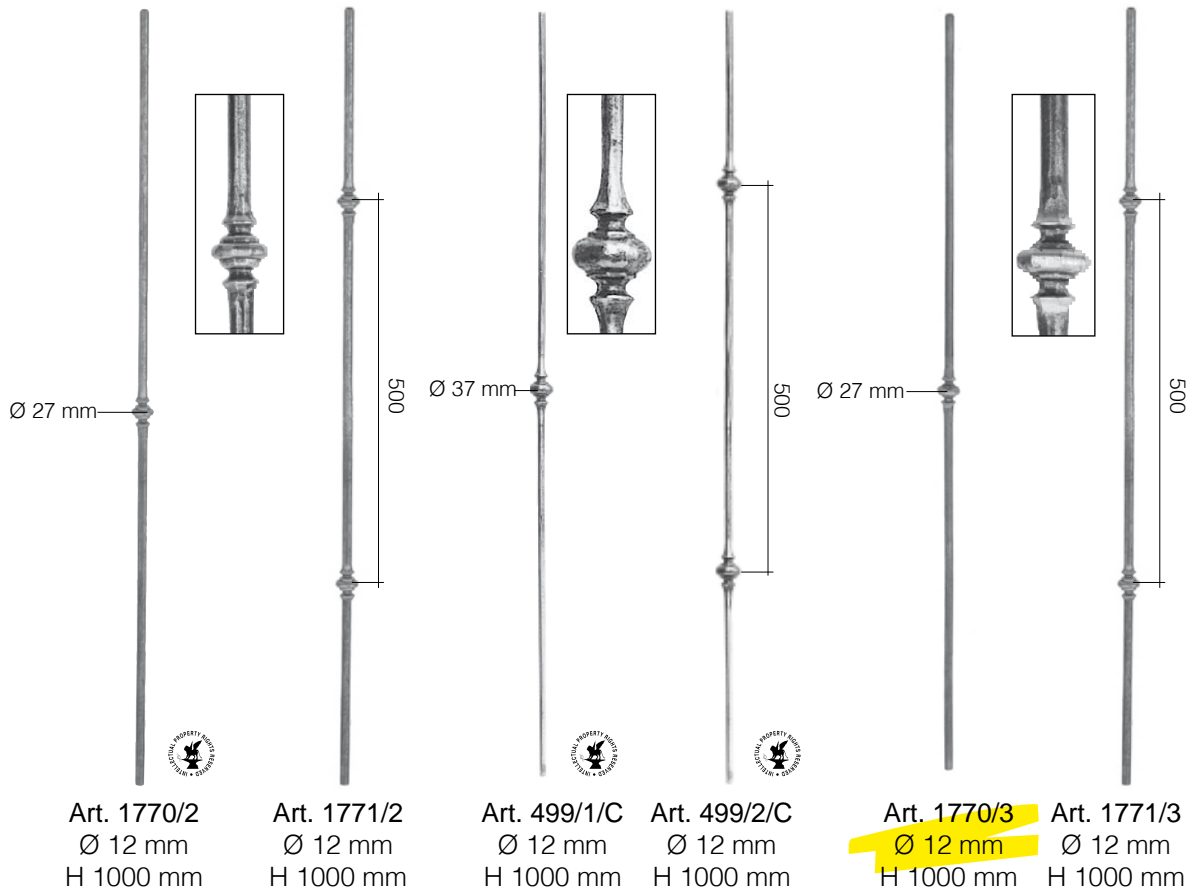

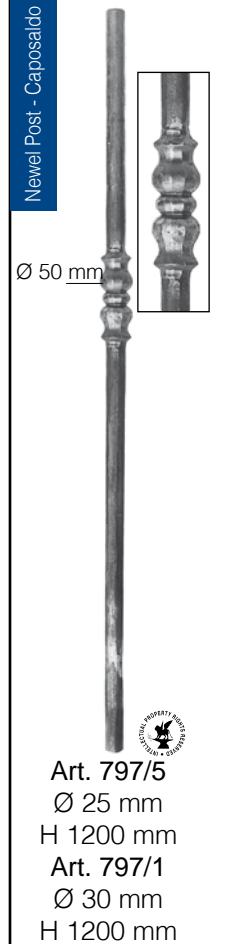
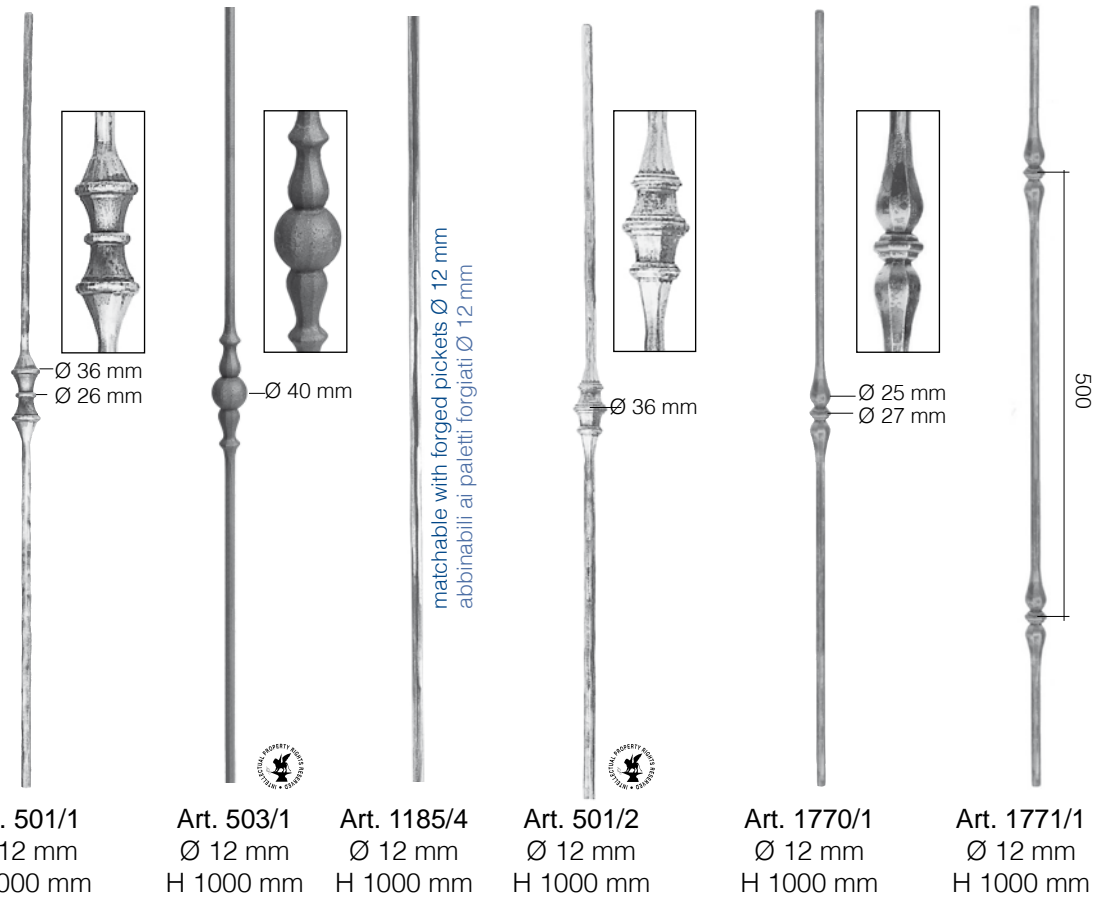
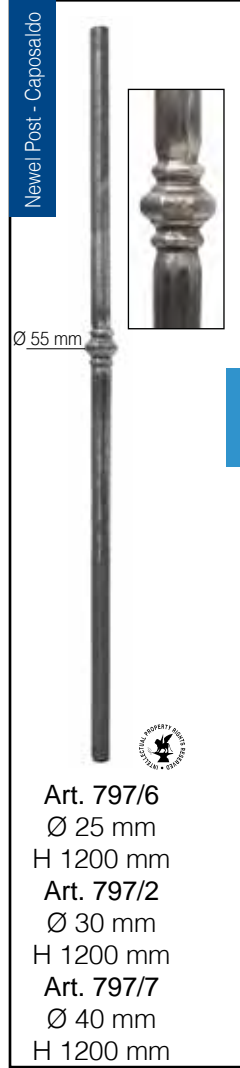
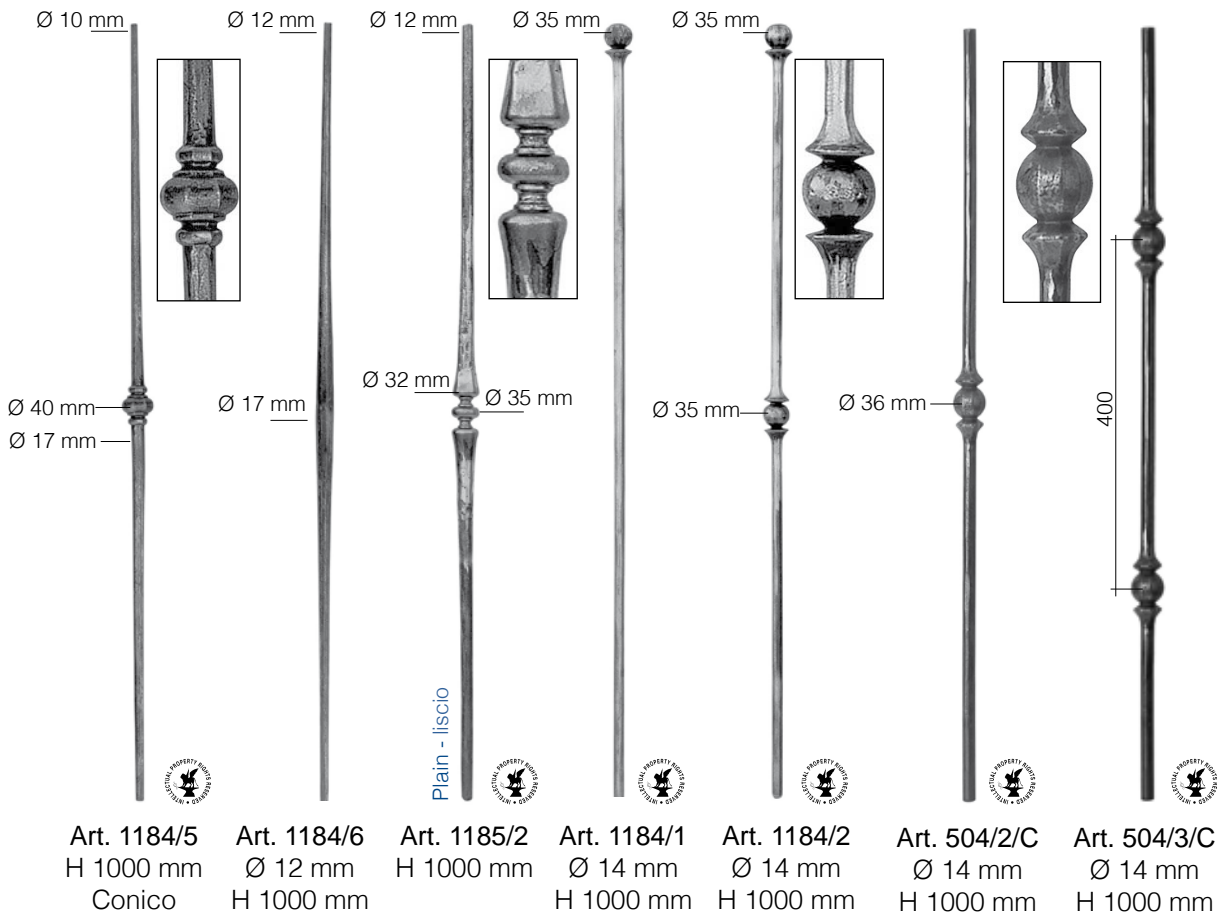

Forged pickets - Paletti forgiati

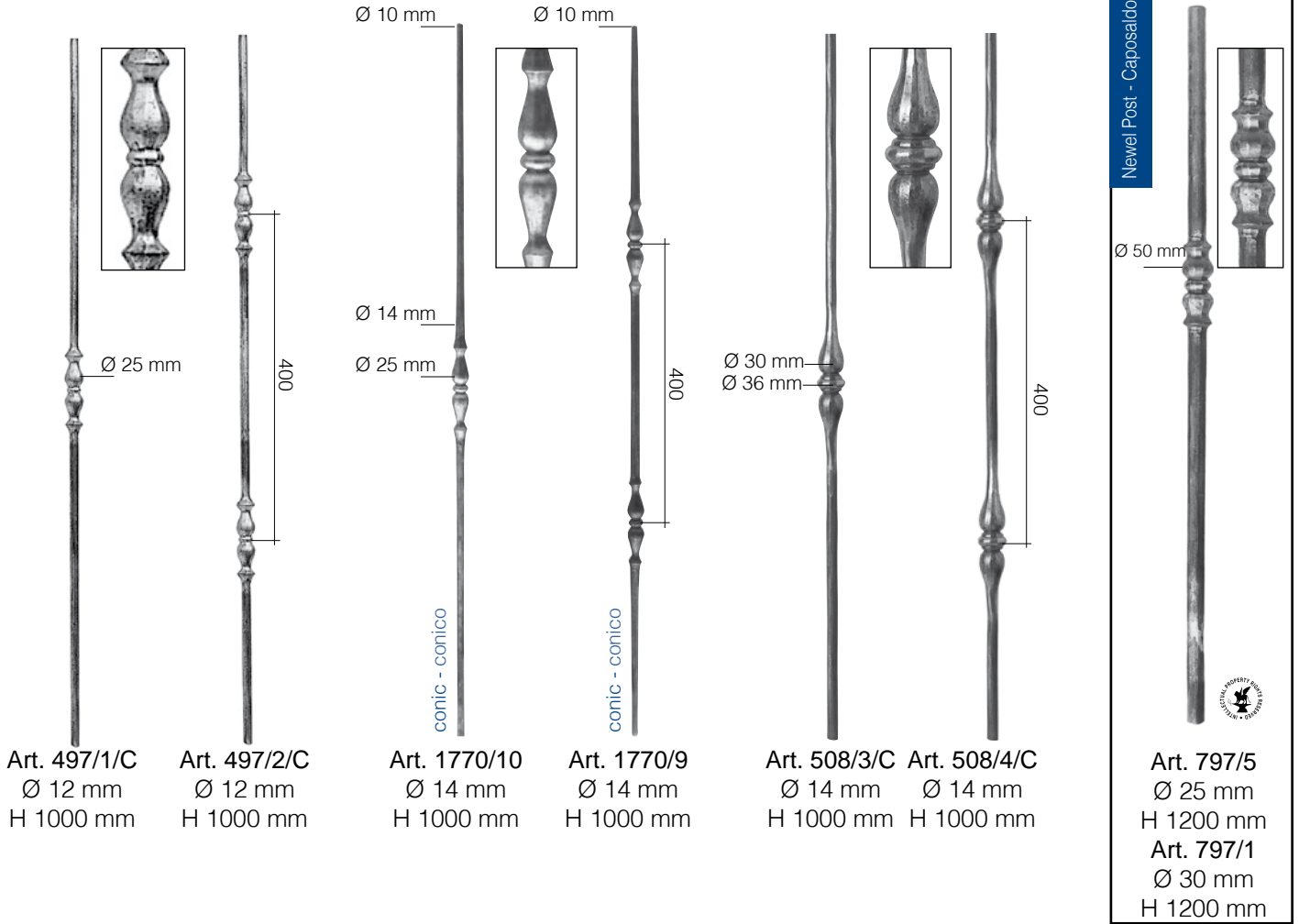

Art. 598/1  
Ø 12 mm  
L 3000 mm  
Art. 598/6  
Ø 25 mm  
L 3000 mm  
Art. 598/7  
Ø 30 mm  
L 3000 mm

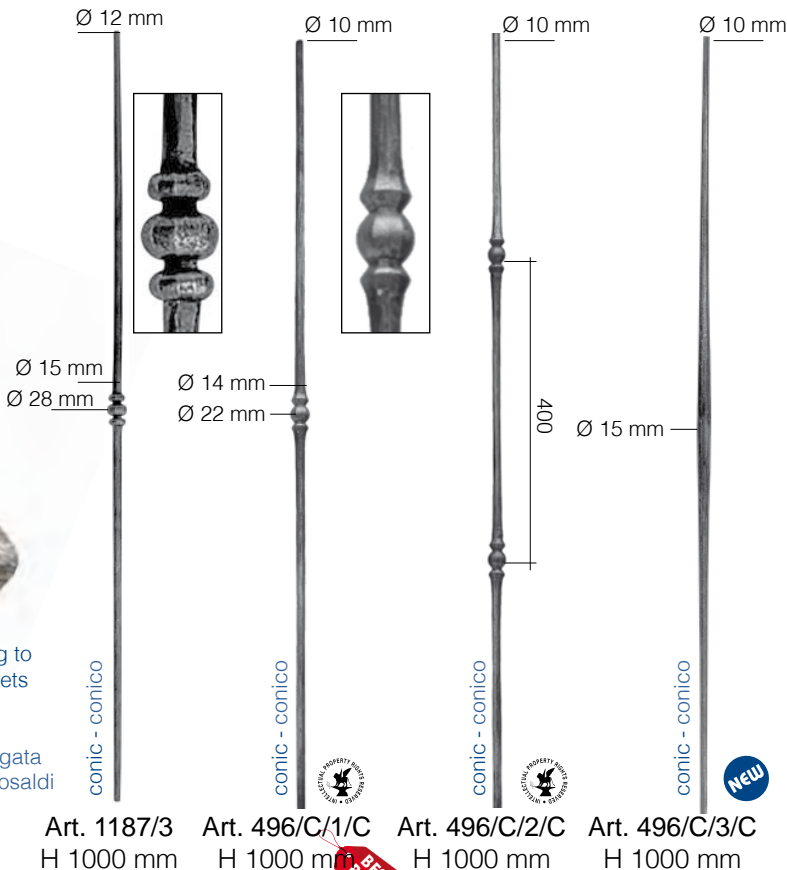

Art. 1187/3 H 1000 mm  
Art. 496/C/1/C H 1000 mm  
Art. 496/C/2/C H 1000 mm  
Art. 496/C/3/C H 1000 mm

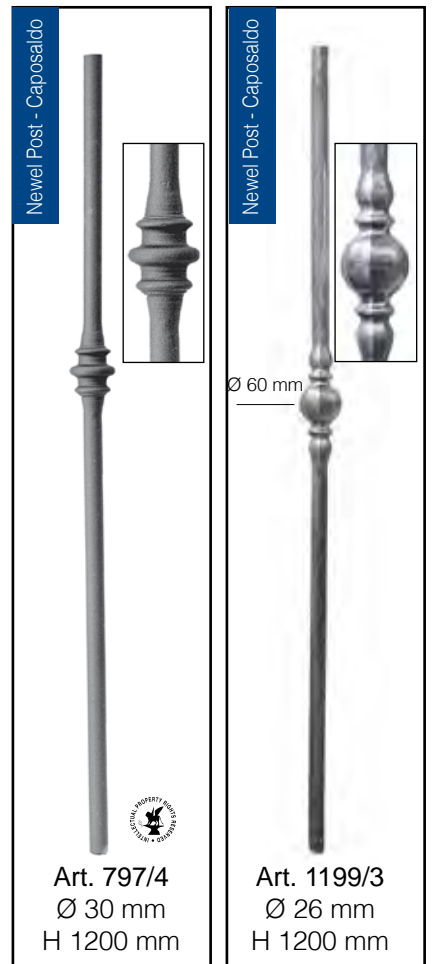

Art. 797/4 Ø 30 mm H 1200 mm  
Art. 1199/3 Ø 26 mm H 1200 mm

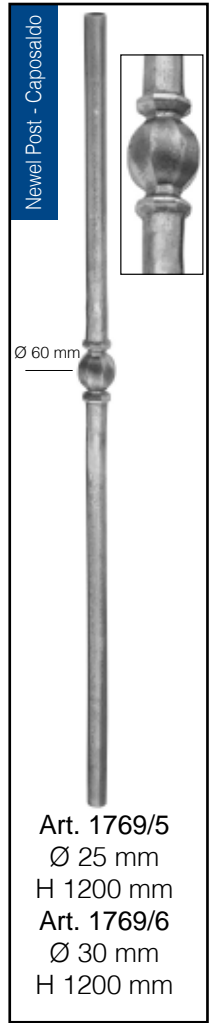
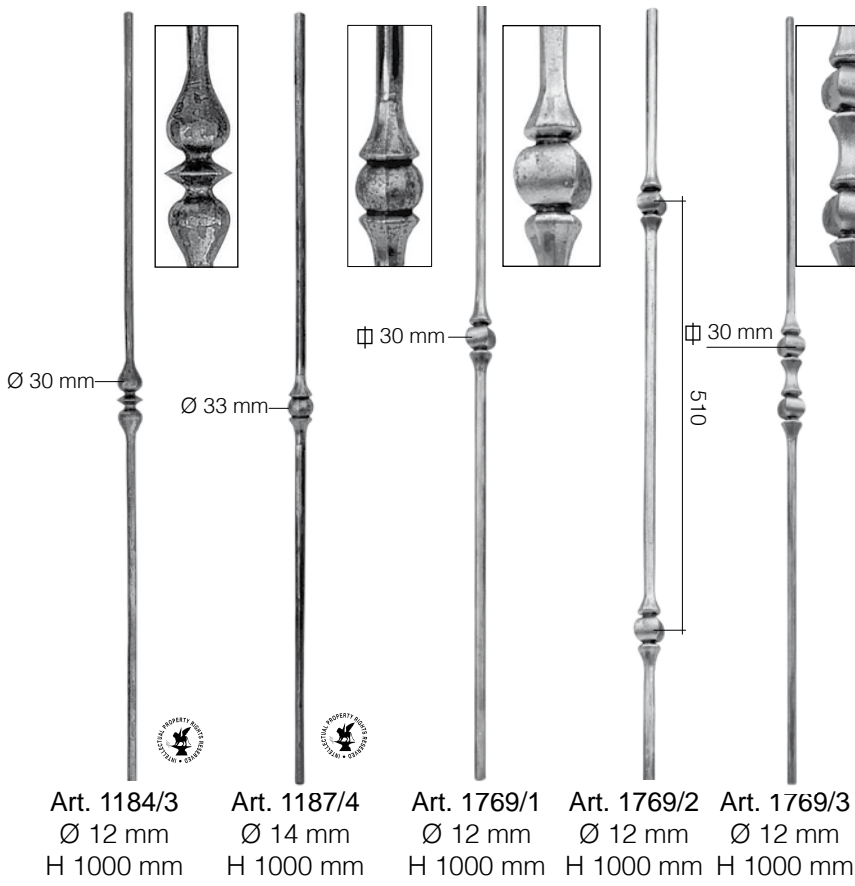

Art. 1184/3 Ø 12 mm H 1000 mm  
 Art. 1187/4 Ø 14 mm H 1000 mm  
 Art. 1769/1 Ø 12 mm H 1000 mm  
 Art. 1769/2 Ø 12 mm H 1000 mm  
 Art. 1769/3 Ø 12 mm H 1000 mm

Art. 1769/5 Ø 25 mm H 1200 mm  
 Art. 1769/6 Ø 30 mm H 1200 mm

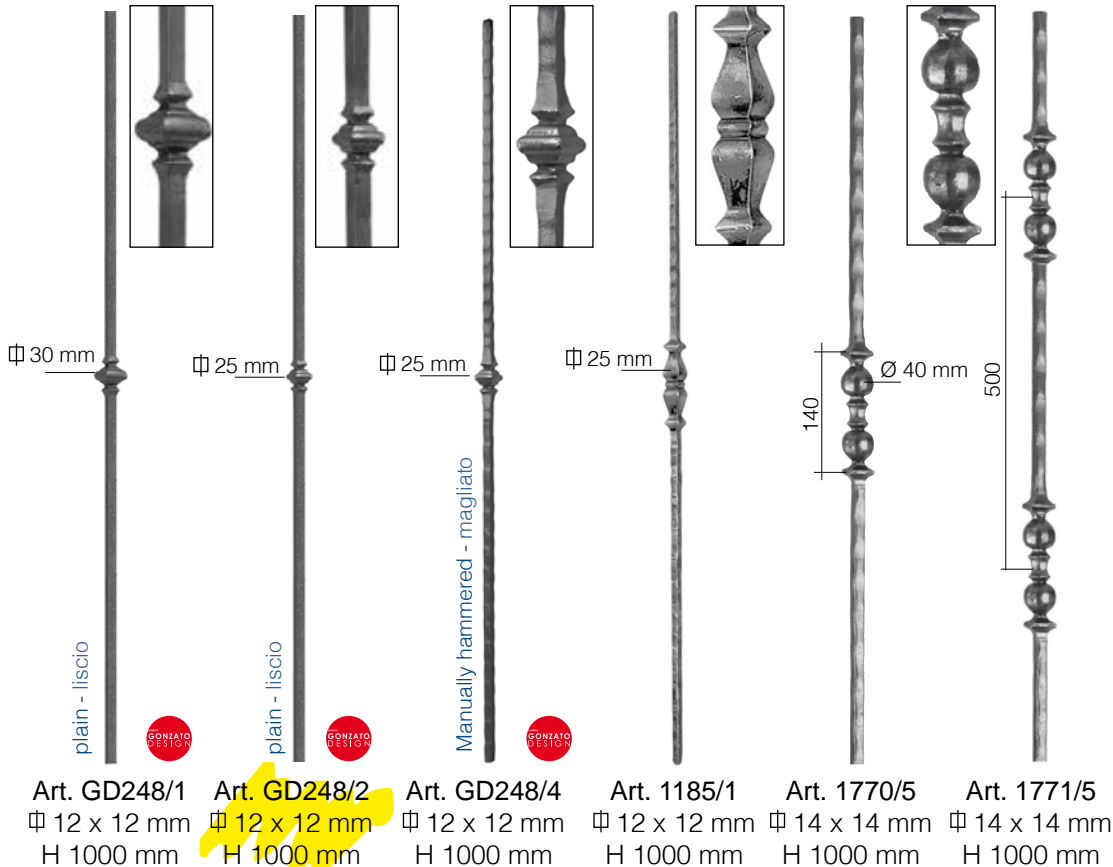

Art. 1370/11 Ø 25 x 25 mm L 2000 mm  
 Art. 1370/12 Ø 30 x 30 mm L 2000 mm

Manually hammered square bar to match with posts  
 Quadro magliato manualmente per abbinamento caposaldi

Art. GD248/1 Ø 12 x 12 mm H 1000 mm  
 Art. GD248/2 Ø 12 x 12 mm H 1000 mm  
 Art. GD248/4 Ø 12 x 12 mm H 1000 mm  
 Art. 1185/1 Ø 12 x 12 mm H 1000 mm  
 Art. 1770/5 Ø 14 x 14 mm H 1000 mm  
 Art. 1771/5 Ø 14 x 14 mm H 1000 mm

Art. 112/11 Ø 25 x 25 mm H 1200 mm

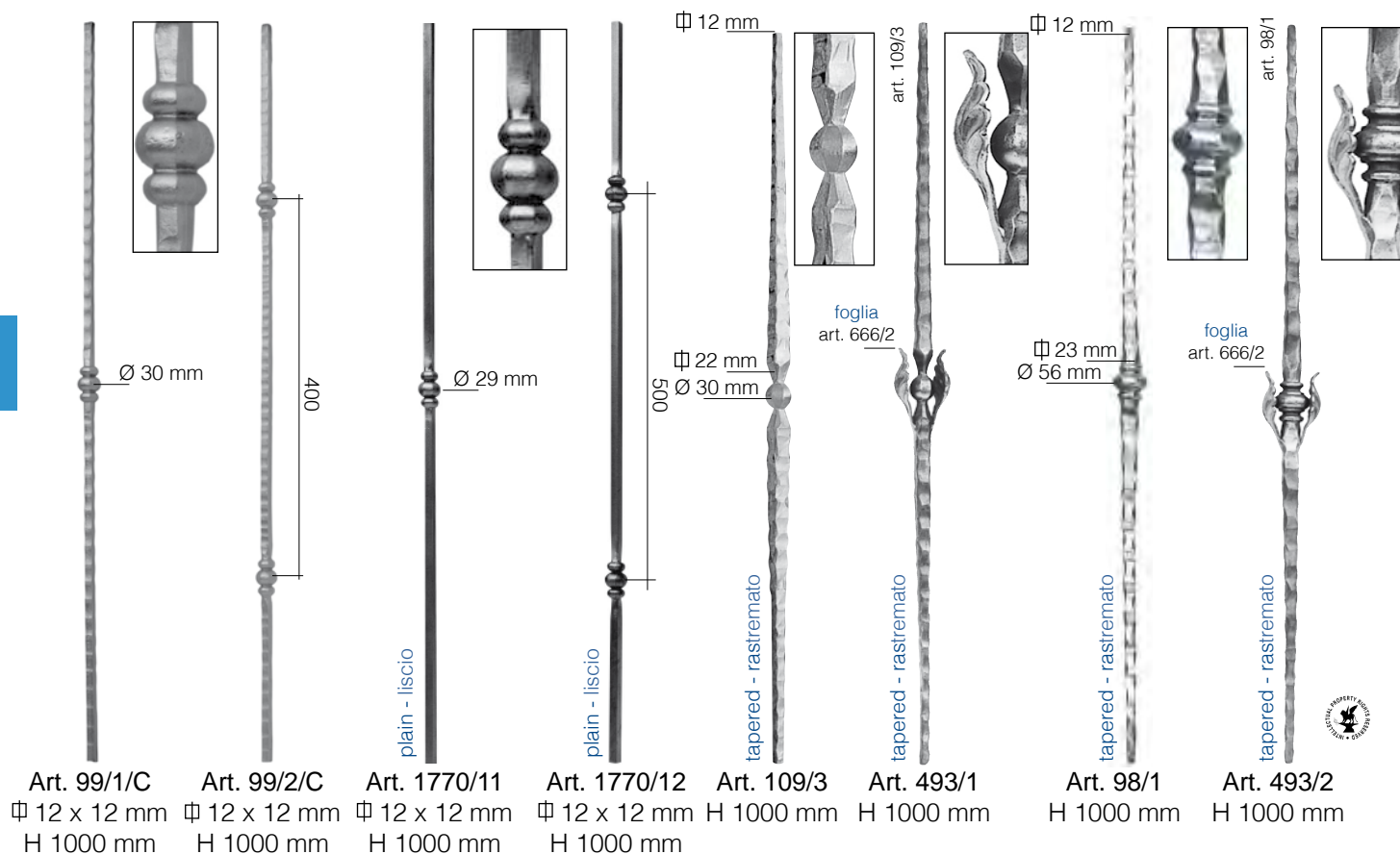

Art. 99/1/C Ø 30 mm  
 Art. 99/2/C 400  
 Art. 1770/11 plain - liscio Ø 29 mm  
 Art. 1770/12 plain - liscio 500  
 Art. 109/3 tapered - rastremato Ø 12 mm Ø 22 mm Ø 30 mm  
 Art. 493/1 tapered - rastremato foglia art. 666/2  
 Art. 98/1 tapered - rastremato Ø 12 mm Ø 23 mm Ø 56 mm  
 Art. 493/2 tapered - rastremato foglia art. 666/2  
 Art. 99/1/C Ø 12 x 12 mm H 1000 mm  
 Art. 99/2/C Ø 12 x 12 mm H 1000 mm  
 Art. 1770/11 Ø 12 x 12 mm H 1000 mm  
 Art. 1770/12 Ø 12 x 12 mm H 1000 mm  
 Art. 109/3 H 1000 mm  
 Art. 493/1 H 1000 mm  
 Art. 98/1 H 1000 mm  
 Art. 493/2 H 1000 mm

  
**The first forged picket in our factory was art. 98/1 and still in production**  
**Il primo paletto forgiato nelle nostre fucine è stato l'art. 98/1 ancora oggi in produzione**

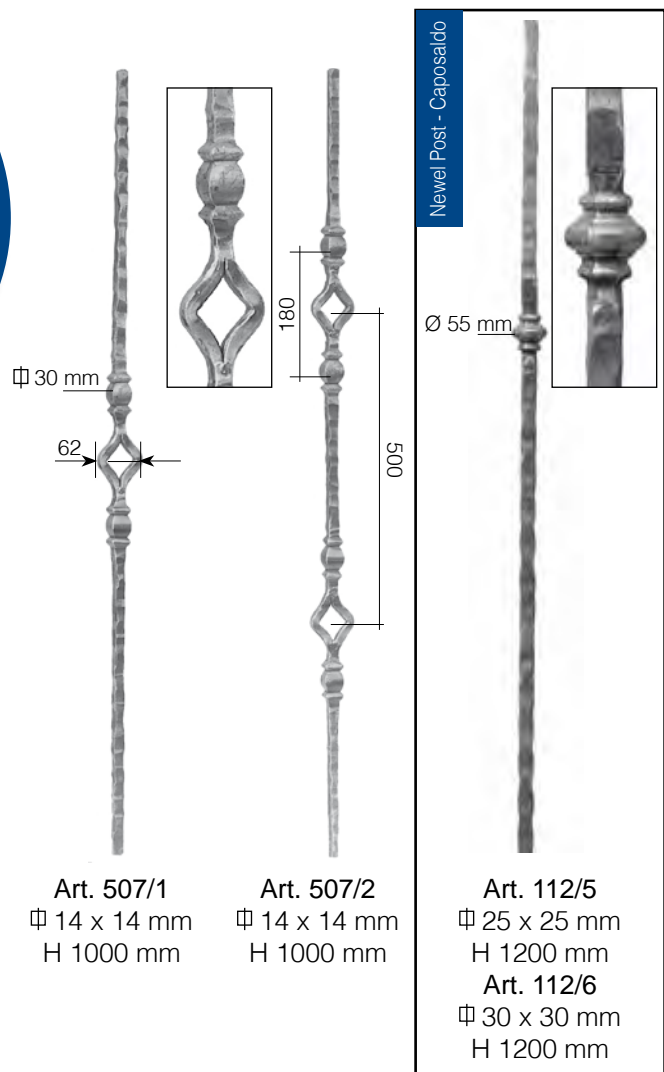
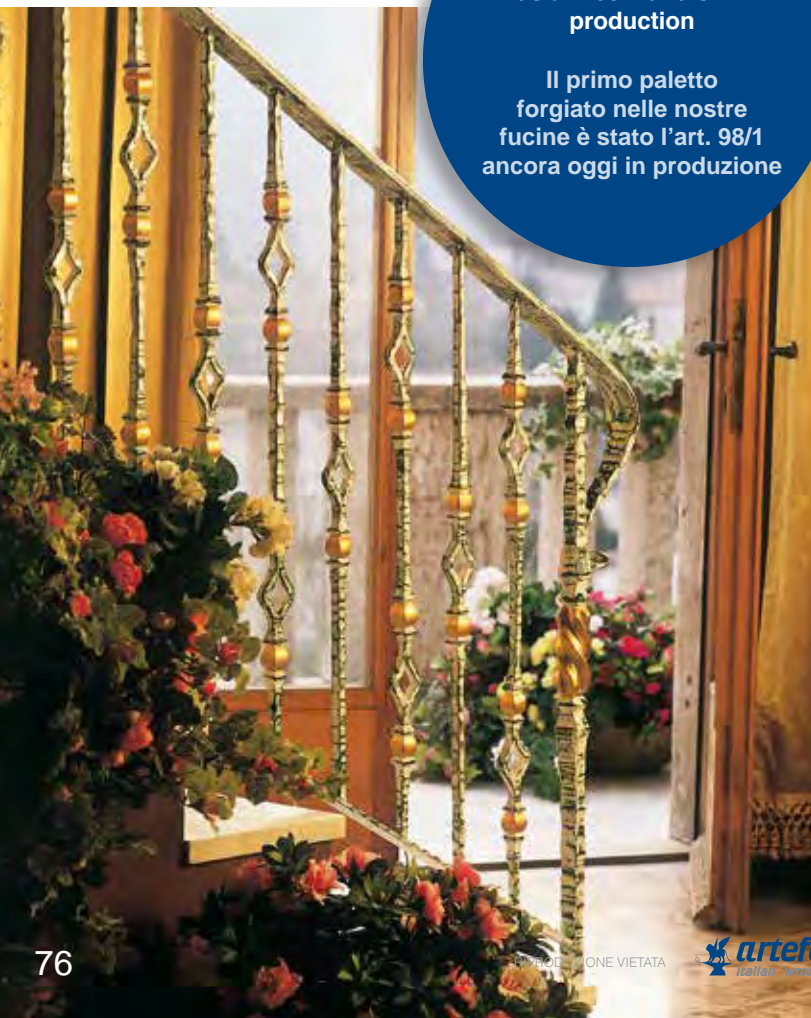

Art. 507/1 Ø 30 mm 62 180  
 Art. 507/2 Ø 30 mm 180  
 Art. 112/5 Ø 55 mm  
 Art. 112/6 Ø 30 x 30 mm H 1200 mm  
 Art. 507/1 Ø 14 x 14 mm H 1000 mm  
 Art. 507/2 Ø 14 x 14 mm H 1000 mm  
 Art. 112/5 Ø 25 x 25 mm H 1200 mm  
 Art. 112/6 Ø 30 x 30 mm H 1200 mm

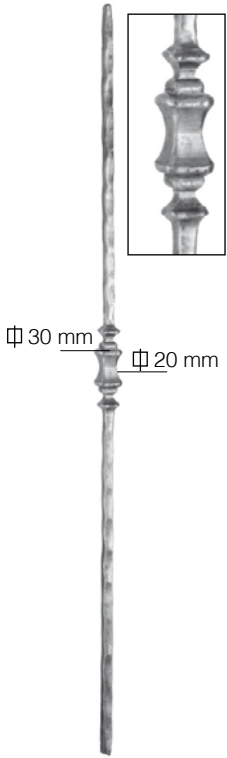

Art. 110/3  
 Ø 12 x 12 mm  
 H 1000 mm

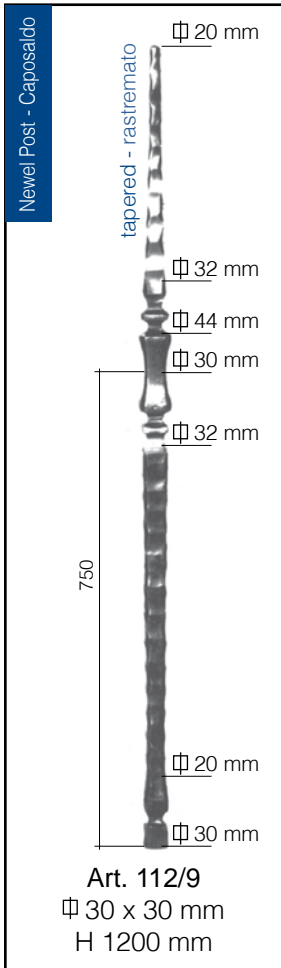

Art. 112/9  
 Ø 30 x 30 mm  
 H 1200 mm

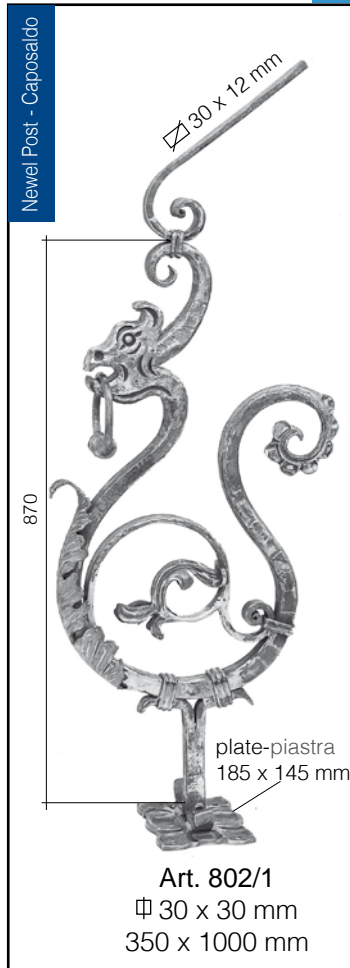

Art. 802/1  
 Ø 30 x 30 mm  
 350 x 1000 mm

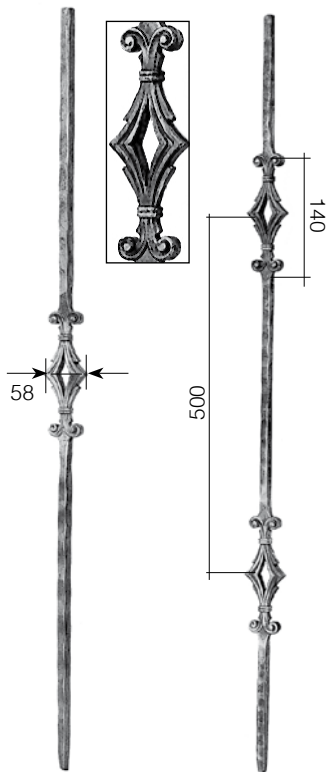

Art. 489/2  
 Ø 14 x 14 mm  
 H 1000 mm

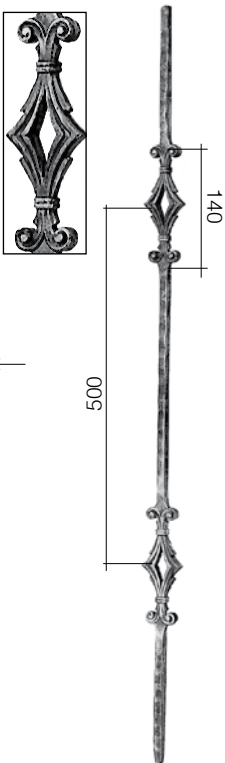

Art. 489/1  
 Ø 14 x 14 mm  
 H 1000 mm

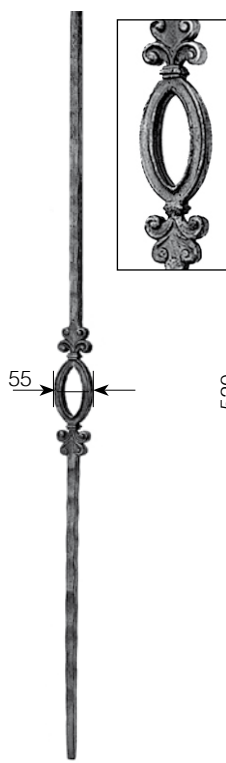

Art. 490/2  
 Ø 14 x 14 mm  
 H 1000 mm

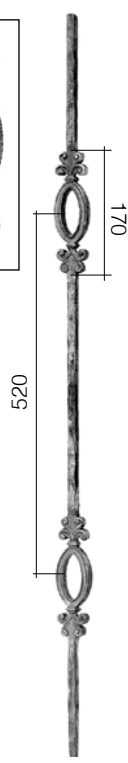

Art. 490/1  
 Ø 14 x 14 mm  
 H 1000 mm

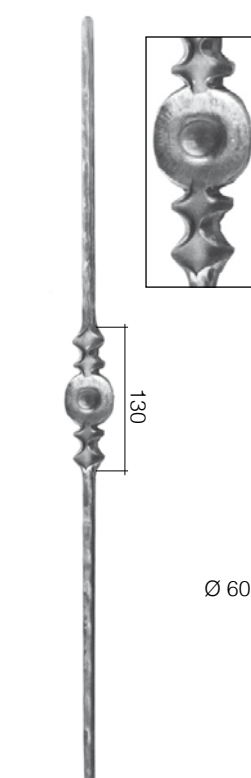

Art. 104/3  
 Ø 12 x 12 mm  
 H 1000 mm

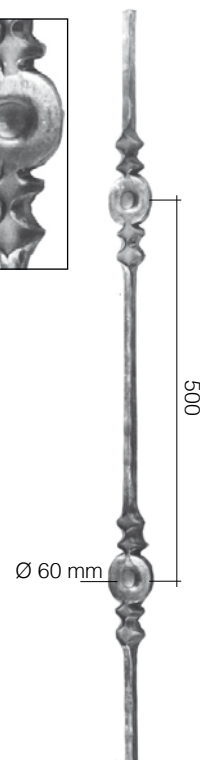

Art. 104/4  
 Ø 12 x 12 mm  
 H 1000 mm

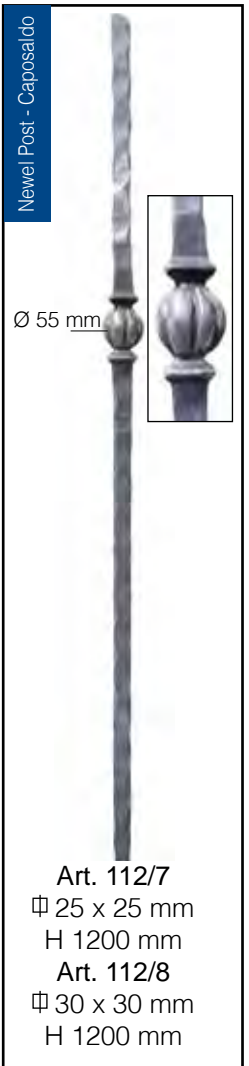

Art. 112/7  
 Ø 25 x 25 mm  
 H 1200 mm

Art. 112/8  
 Ø 30 x 30 mm  
 H 1200 mm

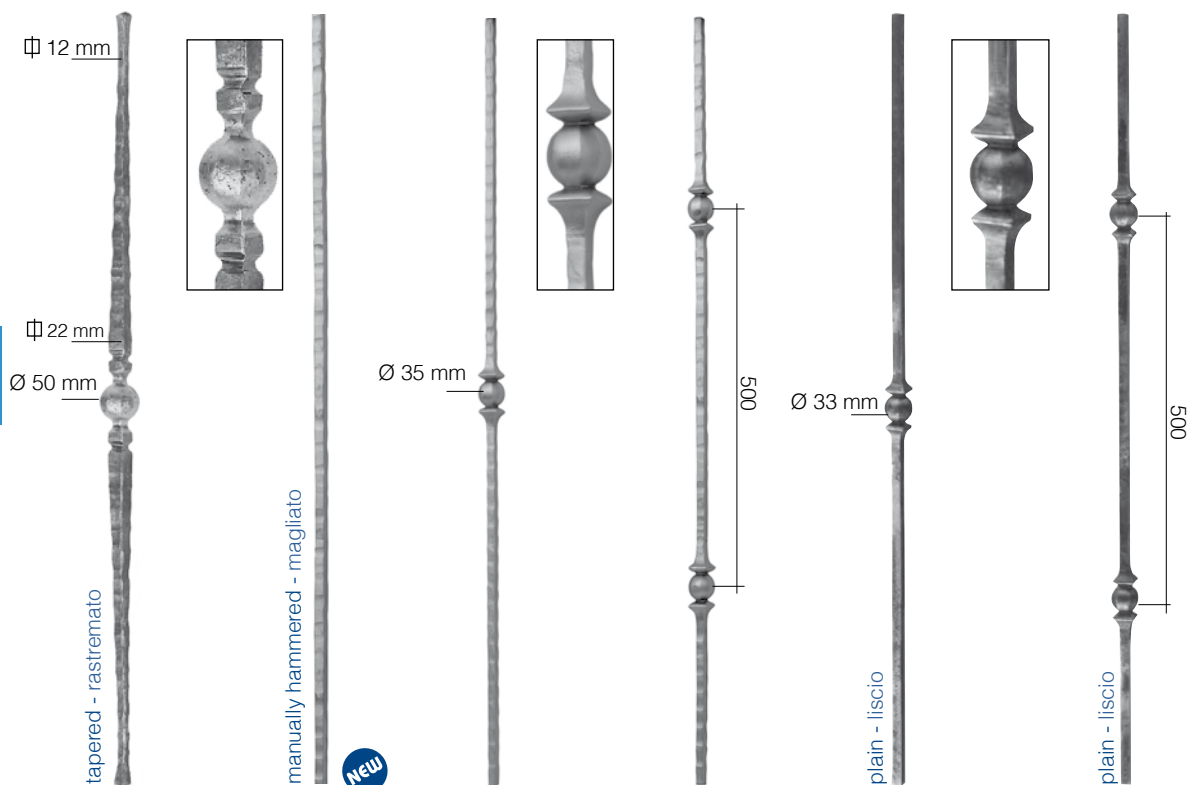

Art. 508/1  
H 1000 mm

Art. 105/5/C  
Ø 12 x 12 mm  
H 1000 mm

Art. 105/2/C  
Ø 12 x 12 mm  
H 1000 mm

Art. 105/1/C  
Ø 12 x 12 mm  
H 1000 mm

Art. 1770/15  
Ø 12 x 12 mm  
H 1000 mm

Art. 1770/13  
Ø 12 x 12 mm  
H 1000 mm

Art. 105/3  
Ø 14 x 14 mm  
H 1000 mm

Art. 1770/16  
Ø 14 x 14 mm  
H 1000 mm

Art. 1770/14  
Ø 14 x 14 mm  
H 1000 mm

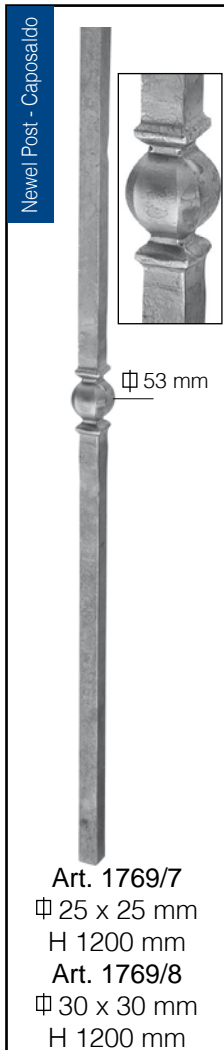

Art. 1769/7  
Ø 25 x 25 mm  
H 1200 mm

Art. 1769/8  
Ø 30 x 30 mm  
H 1200 mm



Art. 509/1  
Ø 12 x 12 mm  
160 x 1000 mm

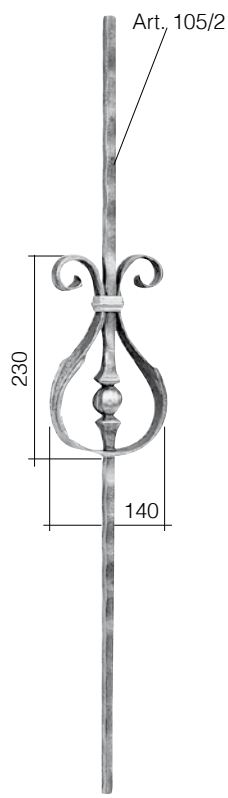

Art. 494/1  
Ø 12 x 12 mm  
140 x 1000 mm

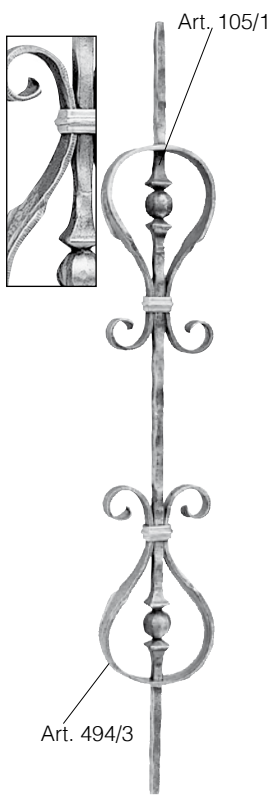

Art. 494/2  
Ø 12 x 12 mm  
140 x 1000 mm



Art. 492/2  
Ø 12 x 12 mm  
H 1000 mm

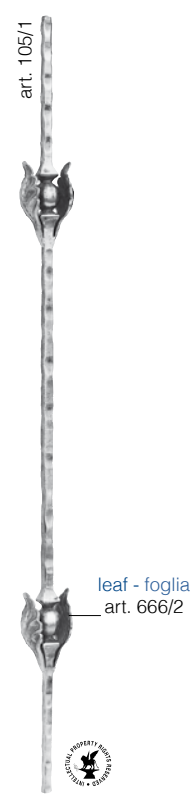

Art. 492/1  
Ø 12 x 12 mm  
H 1000 mm



Art. 801/6  
Ø 30 x 30 mm  
H 1200 mm



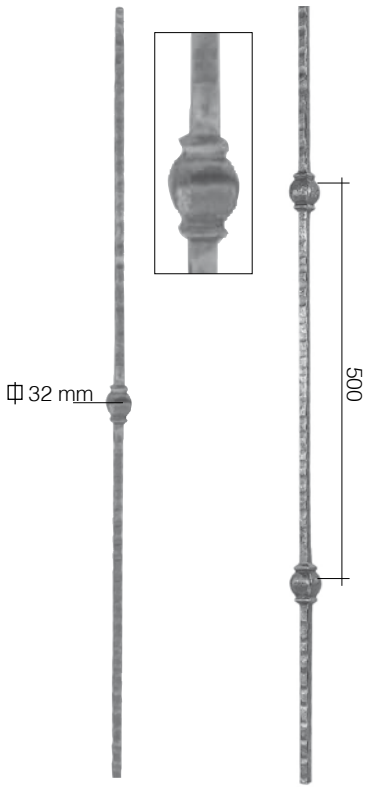

Art. 1770/8  
 Ø 12 x 12 mm  
 H 1000 mm

Art. 1771/8  
 Ø 12 x 12 mm  
 H 1000 mm



Art. 1199/2  
 Ø 25 x 25 mm  
 H 1200 mm

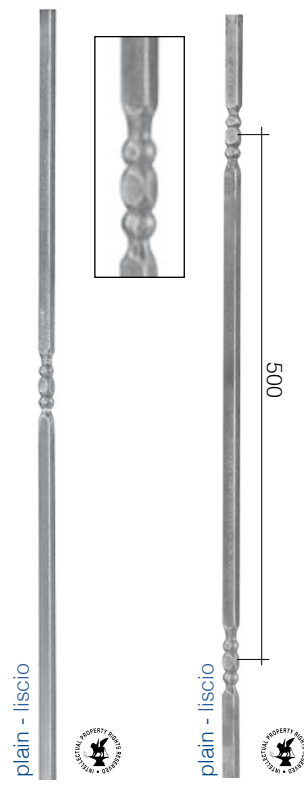

Art. 1773/6  
 Ø 12 x 12 mm  
 H 1000 mm

Art. 1773/5  
 Ø 12 x 12 mm  
 H 1000 mm

Art. 1773/2  
 Ø 14 x 14 mm  
 H 1000 mm

Art. 1773/1  
 Ø 14 x 14 mm  
 H 1000 mm



Art. 505/1  
 Ø 14 x 14 mm  
 H 1000 mm

Art. 505/2  
 Ø 14 x 14 mm  
 H 1000 mm



Art. 800/4  
 Ø 30 x 30 mm  
 H 1200 mm

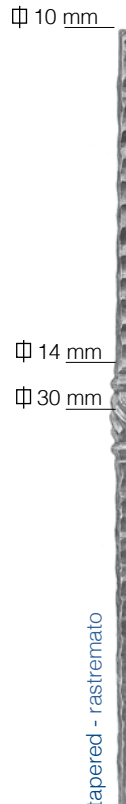

Art. 505/3  
 Ø 14 x 14 mm  
 H 1000 mm

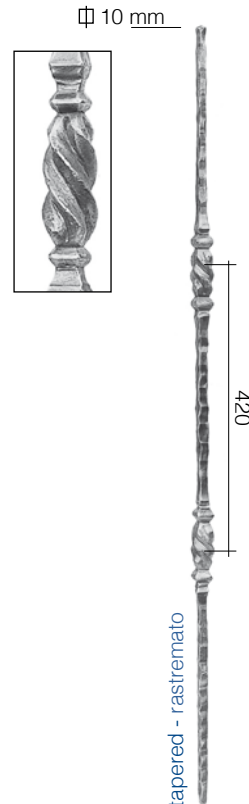

Art. 505/4  
 Ø 14 x 14 mm  
 H 1000 mm

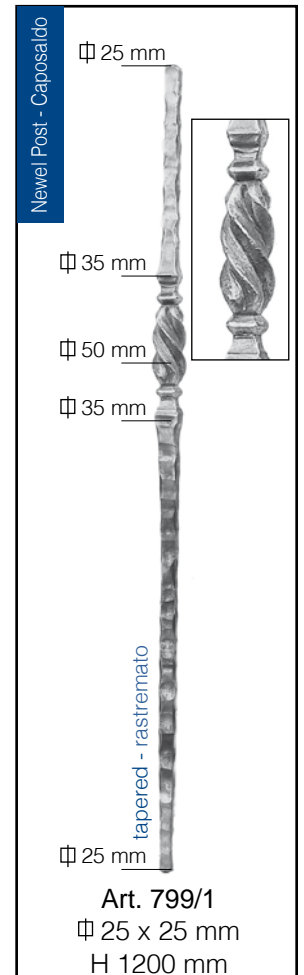

Art. 799/1  
 Ø 25 x 25 mm  
 H 1200 mm

Stamped pickets - Paletti conati

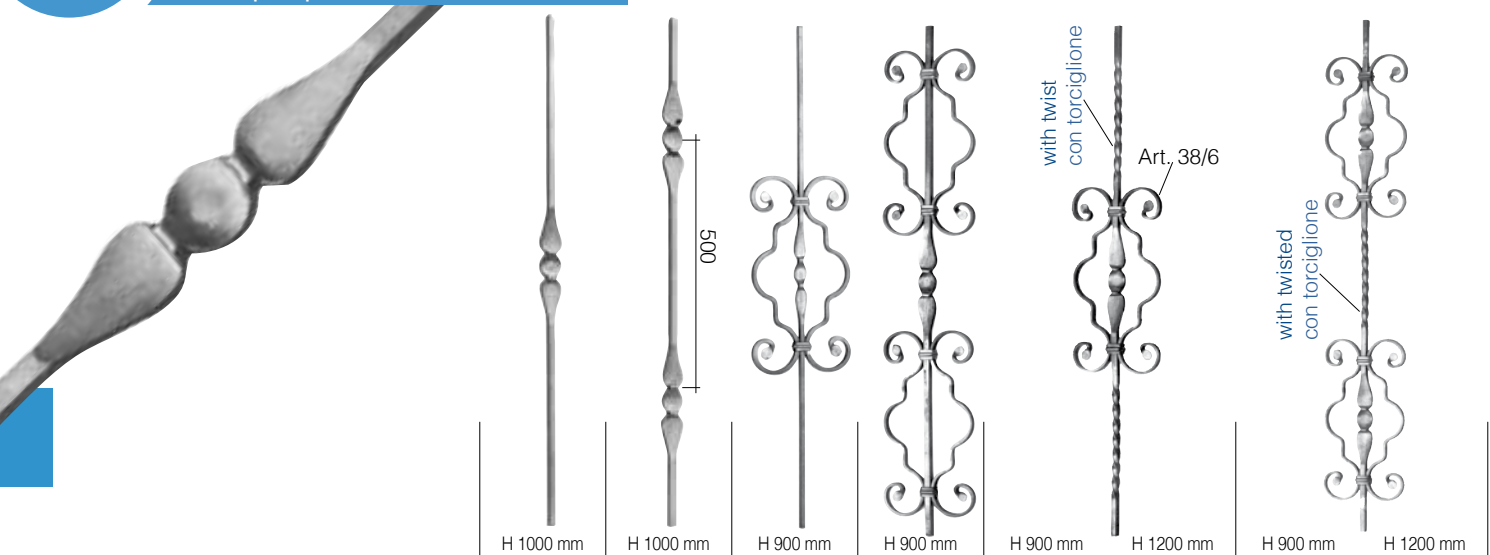

Sec.Sez.	Finish - Finitura	Art.	Art.	Art.	Art.	Art.	Art.	Art.	Art.
Ø 12 mm	Plain - Liscio		134/2	134/10	134/B/2	134/B/4	134/C/2	134/C/3	134/C/5
	Stamped on plain edge Stampato sullo spigolo liscio		1749/11	1749/9					
	Hammered - Spigolato		587/42	587/46					
	Bark effect - Corteccia		1251/1	1251/2					
	Four-leaf clover - Quadrifoglio		-	-					
Ø 14 mm	Plain - Liscio		1251/9	1251/10					
	Plain - Liscio		134/4	134/12					
	Stamped on plain edge Stampato sullo spigolo liscio		1749/12	1749/10					
	Hammered - Spigolato		587/44	587/48					
	Bark effect - Corteccia		1251/3	1251/4					
Four-leaf clover - Quadrifoglio		1251/7	1251/8						
Ø 14 mm	Plain - Liscio		1251/11	1251/12					



Sec.Sez.	Finish - Finitura	Art.	Art.	Art.	Art.	
Ø 12 mm	Plain - Liscio		586/1	134/D/9	585/1	585/2







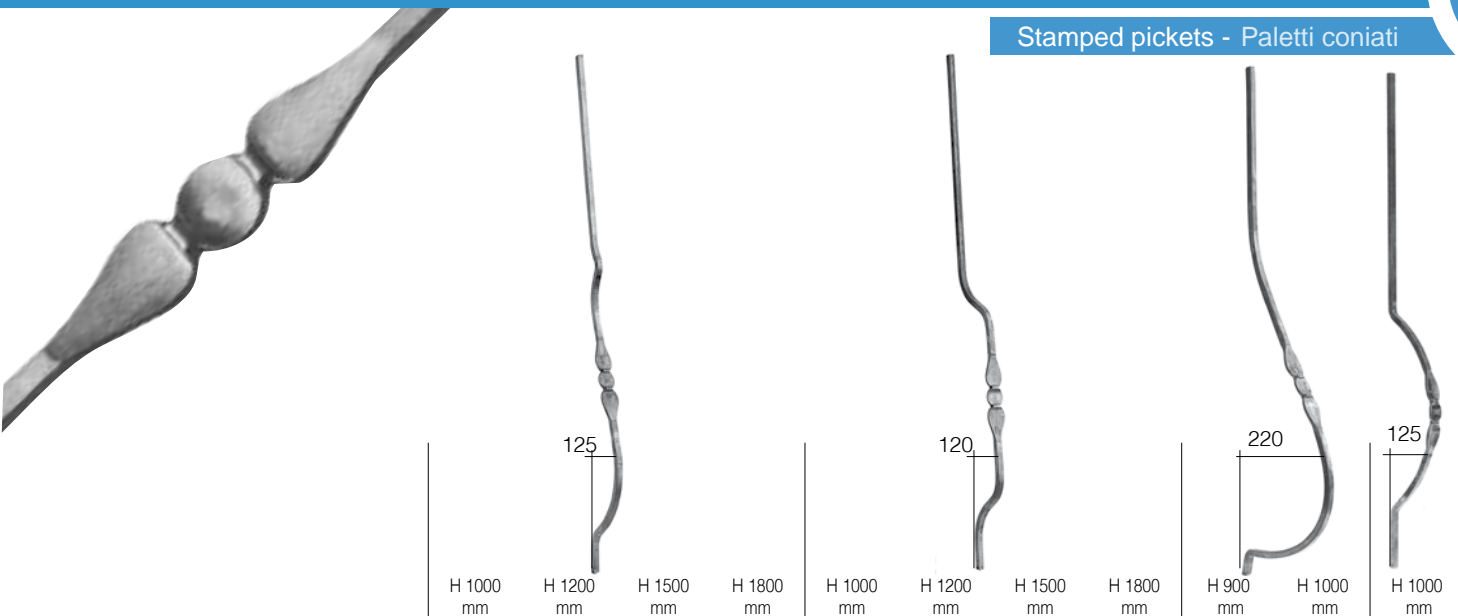

Arteferro products can be manufactured as well as customised.

I prodotti Arteferro sono realizzabili anche su misura.

Stamped pickets - Paletti conati



Sec.Sez.	Finish - Finitura	Art.	Art.	Art.	Art.	Art.	Art.	Art.	Art.	Art.	Art.	Art.
Φ 12 mm	Plain Liscio 	587/2	587/5	587/6	587/7	587/22	587/25	587/26	587/27	586/14	586/6	586/8
	Hammered Spigolato 	587/12	587/15	587/16	587/17	587/24	587/28	587/29	587/30	-	-	-
Ø 12 mm	Plain Liscio 	-	-	-	-	-	-	-	-	-	586/12	586/10
Φ 14 mm	Plain Liscio 	587/4	587/8	587/9	587/10	587/32	587/35	587/36	587/37	586/15	586/7	586/9
	Hammered Spigolato 	587/14	587/18	587/19	587/20	587/34	587/38	587/39	587/40	-	-	-
Ø 14 mm	Plain Liscio 	-	-	-	-	-	-	-	-	-	586/13	586/11

Newel Post - Caposaldo



H 1200 mm

Sec.Sez.	Finish - Finitura	Art.
Φ 25 mm	Plain Liscio 	1775/11
Φ 25 mm	Hammered Spigolato 	1775/6
Φ 30 mm	Plain Liscio 	1775/12
Ø 25 mm	Plain Liscio 	1775/1
Ø 30 mm	Plain Liscio 	1775/2



Stamped pickets - Paletti conati

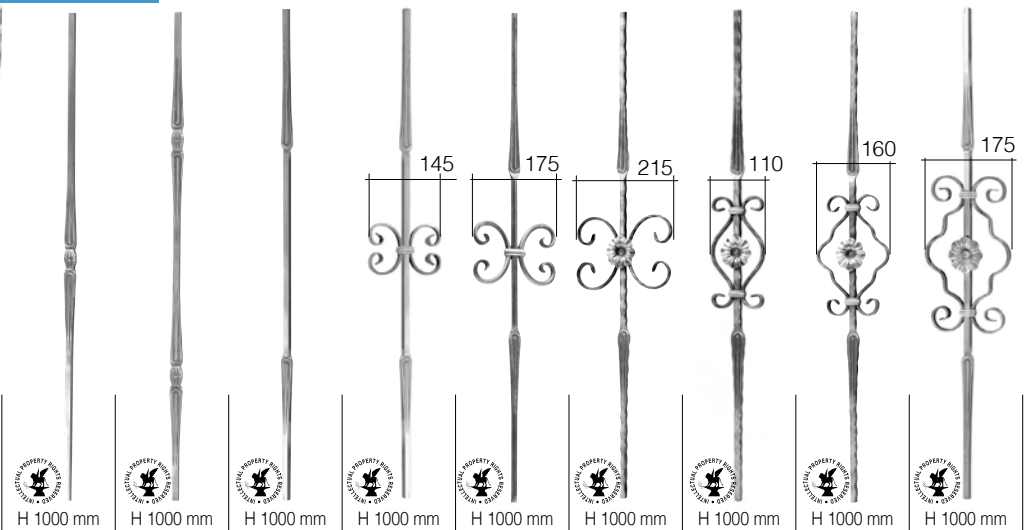

Sec.Sez.	Finish - Finitura	Art.	Art.	Art.	Art.	Art.	Art.	Art.	Art.	Art.
Φ 12 mm	Plain Liscio	1701/1	1701/3	1701/5	1701/7	-	-	-	-	1701/9
	Hammered Spigolato	1709/1	1709/3	1709/5	-	-	1709/7	1709/9	1709/11	-
	Bark effect Corteccia	1710/13	1710/5	1710/17	-	-	1710/19	1710/21	1710/23	-
Ø 12 mm	Plain Liscio	1716/13	1716/15	1716/17	-	1716/19	-	-	1716/21	-
Φ 14 mm	Plain Liscio	1701/2	1701/4	1701/6	1701/8	-	-	-	-	1701/10
	Hammered Spigolato	1709/2	1709/2	1709/6	-	-	1709/8	1709/10	1709/12	-
	Bark effect Corteccia	1710/14	1710/16	1710/18	-	-	1710/20	1710/22	1710/24	-
Ø 14 mm	Plain Liscio	1716/14	1716/16	1716/18	-	1716/20	-	-	1716/22	-

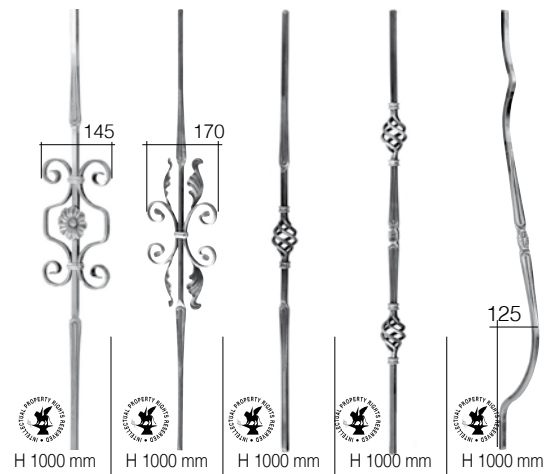

Sec.Sez.	Finish - Finitura	Art.	Art.	Art.	Art.	Art.
Φ 12 mm	Plain Liscio	1701/11	-	1733/9	1733/11	1701/13
	Hammered Spigolato	-	-	-	-	1780/5
	Bark effect Corteccia	-	-	-	-	1780/13
Ø 12 mm	Plain Liscio	-	1716/23	-	-	1779/13
Φ 14 mm	Plain Liscio	1701/12	-	1733/10	1733/12	1701/14
	Bark effect Corteccia	-	-	-	-	1780/6
	Plain Liscio	-	-	-	-	1780/14
Ø 14 mm	Plain Liscio	-	1716/24	-	-	1779/14

Newel Post - Caposaldo

Sec.Sez.	Finish - Finitura	Art.
Φ 25 mm	Plain Liscio	1701/15
	Hammered Spigolato	1777/7
	Bark effect Corteccia	1777/6
Ø 25 mm	Plain Liscio	1777/2

H 1200 mm

Stamped pickets - Paletti conati

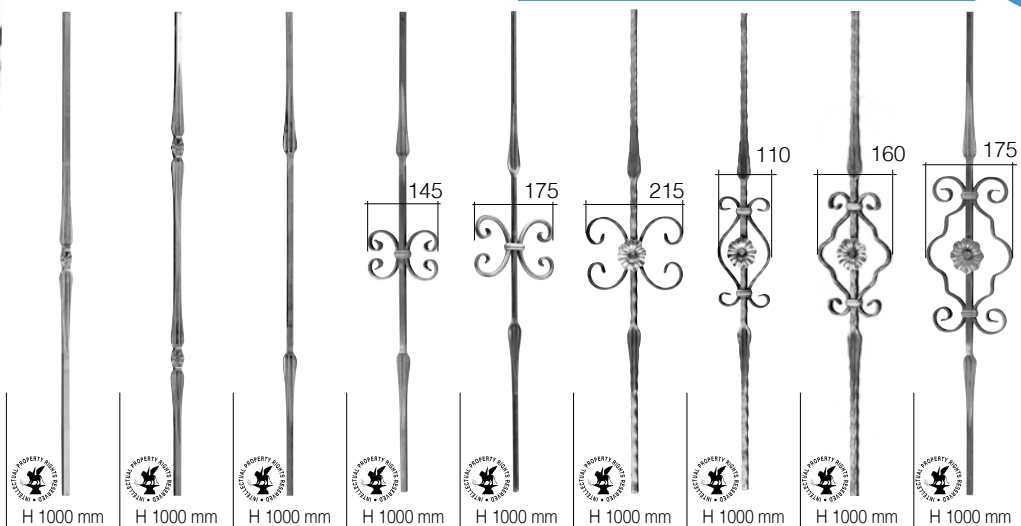

Sec.Sez.	Finish - Finitura	Art.	Art.	Art.	Art.	Art.	Art.	Art.	Art.	Art.
Φ 12 mm	Plain Liscio		1705/1	1705/3	1705/5	1705/7	-	-	-	1705/9
	Hammered Spigolato		1707/1	1707/3	1707/5	-	-	1707/7	1707/8	1707/9
	Bark effect Cortecchia		1710/1	1710/2	1710/5	-	-	1710/7	1710/9	1710/11
Ø 12 mm	Plain Liscio		1716/1	1716/3	1716/5	-	1716/7	-	-	1716/9
Φ 14 mm	Plain Liscio		1705/2	1705/4	1705/6	1705/8	-	-	-	1705/10
	Hammered Spigolato		1707/2	1707/4	1707/6	-	-	1707/10	1707/11	1707/12
	Bark effect Cortecchia		1710/3	1710/4	1710/8	-	-	1710/8	1710/10	1710/12
Ø 14 mm	Plain Liscio		1716/2	1716/4	1716/6	-	1716/8	-	-	1716/10

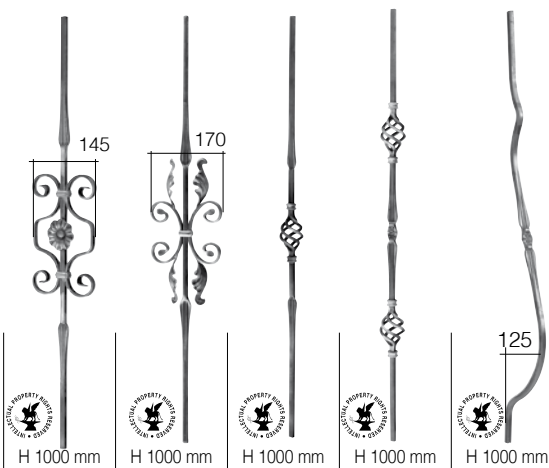

Sec.Sez.	Finish - Finitura	Art.	Art.	Art.	Art.	Art.
Φ 12 mm	Plain Liscio		1705/11	-	1733/1	1733/3
	Hammered Spigolato		-	-	-	-
	Bark effect Cortecchia		-	-	-	-
Ø 12 mm	Plain Liscio		-	1716/11	-	-
Φ 14 mm	Plain Liscio		1705/12	-	1733/2	1733/4
	Hammered Spigolato		-	-	-	-
	Bark effect Cortecchia		-	-	-	-
Ø 14 mm	Plain Liscio		-	1716/12	-	-

Newel Post - Caposaldo

Φ 25 mm	Plain Liscio		1705/15
	Hammered Spigolato		1777/9
	Bark effect Cortecchia		1777/4
	Plain Liscio		1777/1

Stamped pickets - Paletti conati

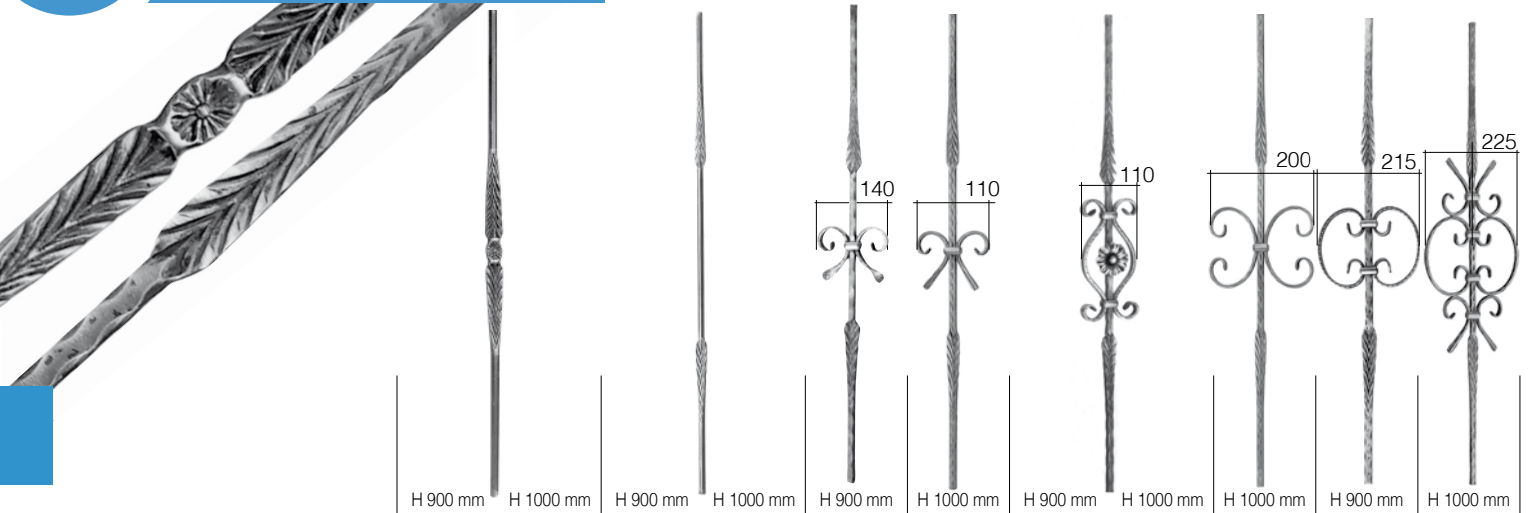

Sec.Sez.	Finish - Finitura	Art.	Art.	Art.	Art.	Art.	Art.	Art.	Art.	Art.	Art.	Art.
Φ 12 mm	Plain Liscio	-	-	-	-	-	-	-	-	-	-	-
	Hammered Spigolato	64/F/2	-	64/F/4	-	64/F/6	-	64/F/8	-	-	561/1	-
	Diamond Diamantato	-	1137/1	-	1137/3	-	1138/3	-	1138/1	1138/5	-	1137/5
Ø 12 mm	Plain Liscio	573/1	573/7	573/3	573/9	-	-	-	-	-	-	-
Φ 14 mm	Plain Liscio	-	-	-	-	-	-	-	-	-	-	-
	Hammered Spigolato	64/F/3	-	64/F/5	-	64/F/7	-	64/F/9	-	-	561/2	-
	Diamond Diamantato	-	1137/2	-	1137/4	-	1138/4	-	1138/2	1138/6	-	1137/6
Ø 14 mm	Plain Liscio	573/2	573/8	573/4	573/10	-	-	-	-	-	-	-

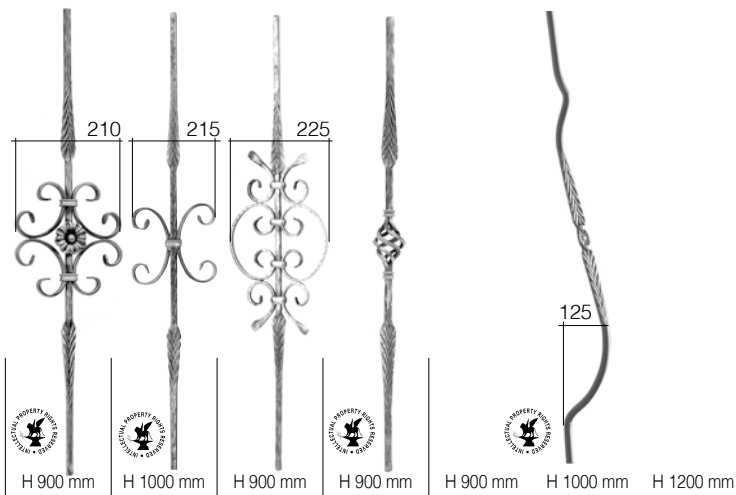

Sec.Sez.	Finish - Finitura	Art.	Art.	Art.	Art.	Art.	Art.	Art.
Φ 12 mm	Plain Liscio	-	-	-	-	-	-	-
	Hammered Spigolato	561/5	561/3	64/G/1	562/1	64/H/9	64/H/9/S	64/H/19
	Diamond Diamantato	-	-	-	-	-	1137/7	1137/9
Ø 12 mm	Plain Liscio	-	-	-	-	572/1	-	572/2
Φ 14 mm	Plain Liscio	-	-	-	-	-	-	-
	Hammered Spigolato	561/6	561/4	64/G/2	562/2	64/H/10	64/H/10/S	64/H/20
	Diamond Diamantato	-	-	-	-	-	1137/8	1137/10
Ø 14 mm	Plain Liscio	-	-	-	-	572/3	-	572/4

Newel Post - Caposaldo

hammered - spigolato

Art. 64/F/1  
Φ 25 x 25 mm  
H 1200 mm

Newel Post - Caposaldo

plain - liscio

Art. 801/1  
Ø 25 mm  
H 1200 mm  
Art. 801/7  
Ø 30 mm  
H 1200 mm

Stamped pickets - Paletti conati

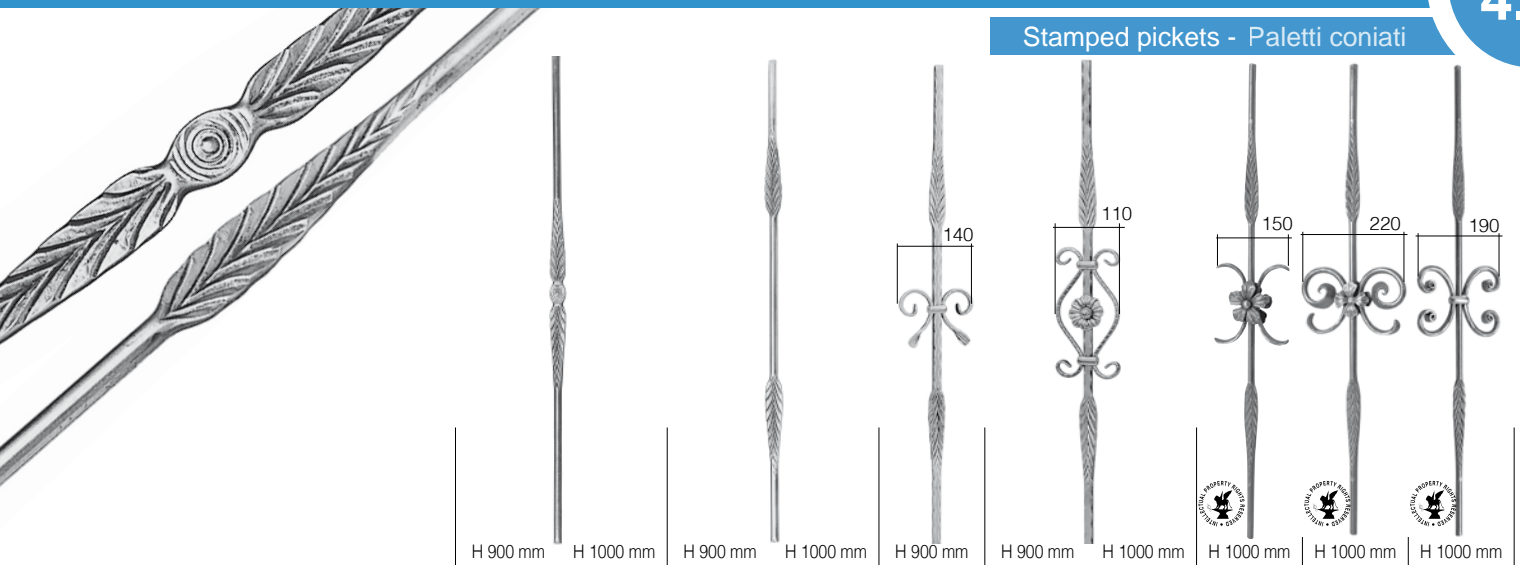

Sec.Sez.	Finish - Finitura	Art.	Art.	Art.	Art.	Art.	Art.	Art.	Art.	Art.	Art.
Φ 12 mm	Plain Liscio	-	-	-	-	-	-	-	-	-	-
	Hammered Spigolato	578/1	1136/5	578/3	1136/6	578/7	578/5	1138/9	-	-	-
	Diamond Diamantato	-	-	-	-	-	-	-	-	-	-
Ø 12 mm	Plain Liscio	576/1	576/5	576/3	576/6	-	-	-	-	-	
Φ 14 mm	Plain Liscio	-	-	-	-	-	-	-	-	-	-
	Hammered Spigolato	578/2	1136/9	578/4	1136/10	578/8	578/6	1138/10	-	-	-
	Diamond Diamantato	-	-	-	-	-	-	-	-	-	-
Ø 14 mm	Plain Liscio	576/2	1135/3	576/6	1135/4	-	-	-	1135/2	1135/1	1136/1

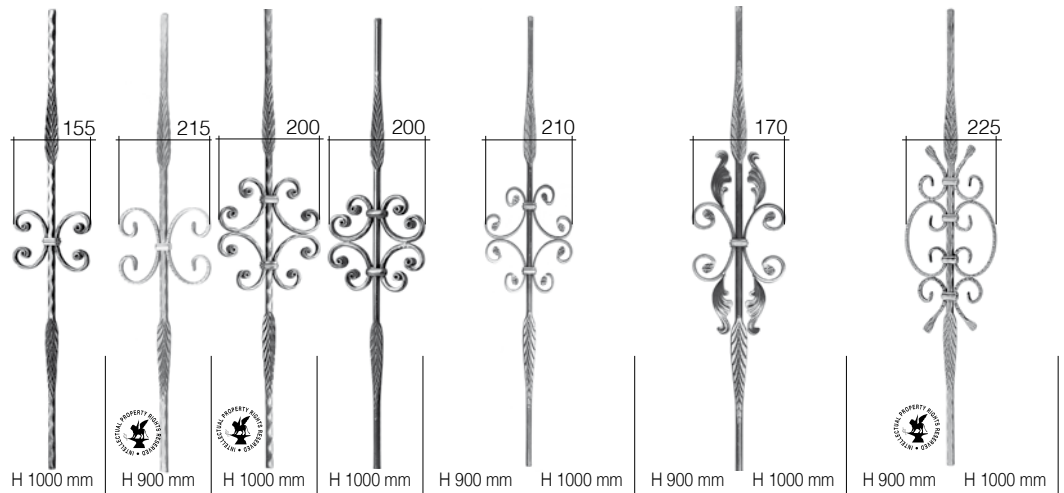



Sec.Sez.	Finish - Finitura	Art.	Art.	Art.	Art.	Art.	Art.	Art.	Art.	Art.	Art.
Φ 12 mm	Plain Liscio	-	-	-	-	-	-	-	-	-	-
	Hammered Spigolato	-	578/11	1136/4	-	-	-	-	-	578/9	-
	Diamond Diamantato	-	-	1138/7	-	-	-	-	-	-	-
Ø 12 mm	Plain Liscio	1136/3	-	-	-	577/7	577/8	577/9	577/10	-	-
Φ 14 mm	Plain Liscio	-	-	-	-	-	-	-	-	-	-
	Hammered Spigolato	-	578/12	1136/8	-	-	-	-	-	578/10	-
	Diamond Diamantato	-	-	1138/8	-	-	-	-	-	-	-
Ø 14 mm	Plain Liscio	1136/7	-	-	1136/2	577/1	577/4	577/2	577/5	-	-

Stamped pickets - Paletti conati



Sec.Sez.	Finish - Finitura	Art.	Art.	Art.	Art.
Φ 12 mm	Plain Liscio 	-	-	-	-
	Hammered Spigolato 	-	-	578/17	578/18
	Diamond Diamantato 	-	-	-	-
Ø 12 mm	Plain Liscio 	1734/1	1734/2	578/13	578/14
Φ 14 mm	Plain Liscio 	-	-	-	-
	Hammered Spigolato 	-	-	578/19	578/20
	Diamond Diamantato 	-	-	-	-
Ø 14 mm	Plain Liscio 	-	-	578/15	578/16

Newel Post - Caposaldo

Sec.Sez.	Finish - Finitura	Art.	Art.
Φ 25 mm	Hammered Spigolato 	801/2	-
Ø 25 mm	Plain Liscio 	-	801/5
Ø 30 mm	Plain Liscio 	-	801/8





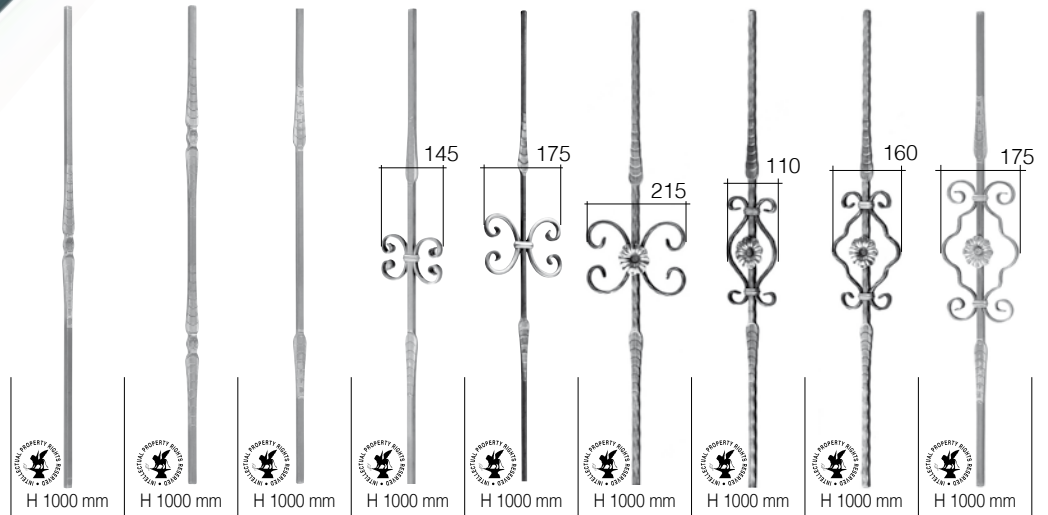

Sezione	Finish - Finitura	Art.	Art.	Art.	Art.	Art.	Art.	Art.	Art.	Art.
Ø 12 mm	Plain Liscio	1702/1	1702/3	1702/5	1702/7	-	-	-	-	1702/9
	Hammered Spigolato	1709/13	1709/15	1709/17	-	-	1709/19	1709/21	1709/23	-
	Bark effect Cortecchia	1713/1	1713/3	1713/5	-	-	1713/7	1713/9	1713/11	-
Ø 12 mm	Plain Liscio	1714/1	1714/3	1714/5	-	1714/7	-	-	1714/9	-
	Hammered Spigolato	1709/14	1709/16	1709/18	-	-	1709/20	1709/22	1709/24	-
Ø 14 mm	Plain Liscio	1702/2	1702/4	1702/6	1702/8	-	-	-	-	1702/10
	Hammered Spigolato	1709/14	1709/16	1709/18	-	-	1709/20	1709/22	1709/24	-
	Bark effect Cortecchia	1713/2	1713/4	1713/6	-	-	1713/8	1713/10	1713/12	-
Ø 14 mm	Plain Liscio	1714/2	1714/4	1714/6	-	1714/8	-	-	1714/10	-

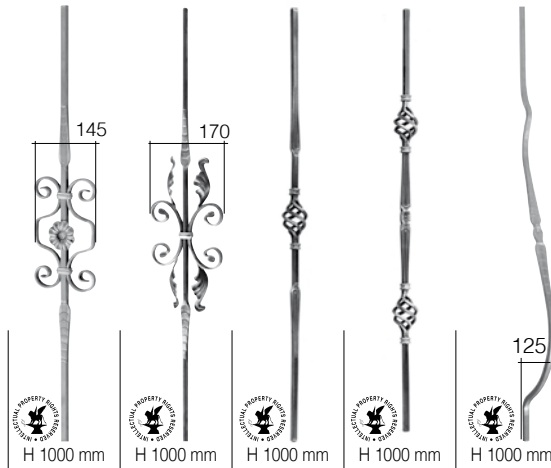

Sezione	Finish - Finitura	Art.	Art.	Art.	Art.	Art.
Ø 12 mm	Plain Liscio	1702/11	-	1733/5	1733/7	1702/13
	Hammered Spigolato	-	-	-	-	1780/3
	Bark effect Cortecchia	-	-	-	-	1780/11
Ø 12 mm	Plain Liscio	-	1714/11	-	-	1779/11
Ø 14 mm	Plain Liscio	1702/12	-	1733/6	1733/8	1702/14
	Hammered Spigolato	-	-	-	-	1780/4
	Bark effect Cortecchia	-	-	-	-	1780/12
Ø 14 mm	Plain Liscio	-	1714/12	-	-	1779/12

Newel Post - Caposaldo

Ø 25 mm	Plain Liscio	1702/15
	Hammered Spigolato	1777/8
	Bark effect Cortecchia	1777/5
Ø 25 mm	Plain Liscio	1777/3

Stamped pickets - Paletti conati

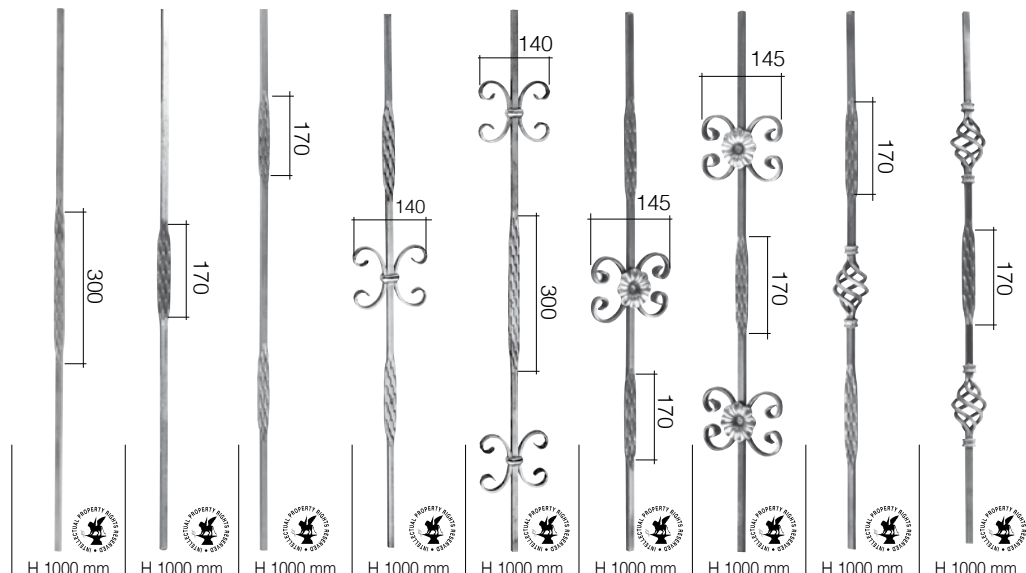
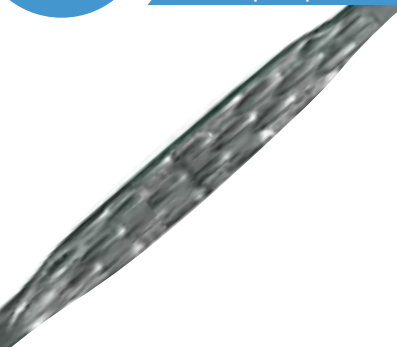

Sec.Sez.	Finish - Finitura	Art.	Art.	Art.	Art.	Art.	Art.	Art.	Art.	Art.
12 mm	Plain Liscio	1727/1	1729/11	1727/3	1727/5	1727/7	1729/7	1729/5	1729/3	1729/1
Φ 14 mm	Plain Liscio	1727/2	1729/12	1727/4	1727/6	1727/8	1729/8	1729/6	1729/4	1729/2

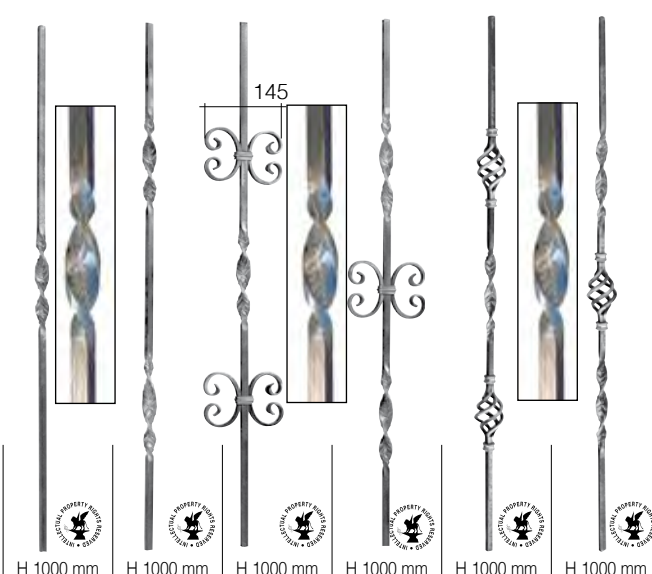



Sec.Sez.	Finish - Finitura	Art.	Art.	Art.	Art.	Art.	Art.
Φ 12 mm	Plain Liscio	1730/11	1730/9	1730/13	1730/15	1733/15	1733/13
Φ 14 mm	Plain Liscio	1730/12	1730/10	1730/14	1730/16	1733/16	1733/14

Newel Post - Caposaldo



Sec.Sez.	Finish - Finitura	Art.	Art.
Φ 20 mm	Plain Liscio	1775/7	-
Φ 25 mm	Plain Liscio	1775/8	1730/17
Φ 30 mm	Plain Liscio	1777/9	-

Stamped pickets - Paletti conati





Sec.Sez.	Finish - Finitura	Art.	Art.
∅ 12 mm	Plain Liscio 	1730/3	1730/1
∅ 14 mm	Plain Liscio 	1730/4	1730/2



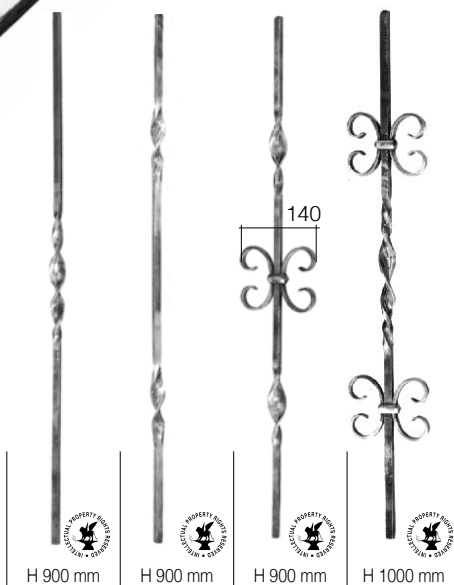

Sec.Sez.	Finish - Finitura	Art.	Art.
∅ 12 mm	Plain Liscio 	1730/7	1730/5
∅ 14 mm	Plain Liscio 	1730/8	1730/6



Sec.Sez.	Finish - Finitura	Art.	Art.	Art.	Art.
∅ 12 mm	Plain Liscio 	50/5	50/6	50/7	50/8
∅ 14 mm	Plain Liscio 	50/9	50/10	50/11	50/12
∅ 16 mm	Plain Liscio 	50/13	50/14	50/15	50/16

Newel Post - Caposaldo



Sec.Sez.	Finish - Finitura	Art.
∅ 20 mm	Plain Liscio 	113/5
∅ 30 mm	Plain Liscio 	113/6



Stamped pickets - Paletti conati



bush  
borchia

H 1000 mm H 1000 mm

Sec.Sez.	Finish - Finitura	Bush - Borchia	Art.	Art.
Φ 12 mm	Plain Liscio	1393/19	1746/1	1746/2
	Hammered Spigolato		1746/3	1746/4
	Bark effect Corteccia		1746/5	1746/6
	Plain Liscio	1391/21 cast steel bush borchia ferro fuso	1176/1/S	1176/2/S
	Bark effect Corteccia		1176/3/S	1176/4/S
Ø 12 mm	Plain Liscio	1466/4 1466/5 brass - ottone	1179/1	1179/2
	Plain Liscio	1466/14 lathed bush borchia tornita	GD275/1	GD275/7
	Plain Liscio	739/1	1177/1	1177/2
	Plain Liscio	1393/27/S	1177/5	1177/6
	Plain Liscio	1394/22 hollow sphere sfera vuota	1177/9	1177/10
Ø 14 mm	Plain Liscio	1466/14 lathed bush borchia tornita	GD275/1	GD275/7
	Plain Liscio	739/1	1177/3	1177/4
	Plain Liscio	1393/28/S	1177/7	1177/8
	Plain Liscio	1466/13 lathed bush borchia tornita	GD275/3	GD275/9
	Plain Liscio	1466/15 lathed bush borchia tornita	GD275/2	GD275/8
	Plain Liscio	1466/4 1466/5 brass - ottone	1179/3	1179/4

Newel Post - Caposaldo



Art. 64/I/1  
Φ 25 x 25 mm  
H 1200 mm

Newel Post - Caposaldo



hollow sphere  
sfera vuota  
1394/12/S

Art. 1205/2  
Ø 25 mm  
H 1200 mm

Newel Post - Caposaldo



128/C/5

Art. 1205/1  
Ø 25 mm  
H 1200 mm



**PLAIN PICKETS - PALETTI LISCI**  
**TUBE-TUBO Ø 30 mm THICKN. - SPESS. 1,5 mm**



Art. 148/2  
 Ø 30 mm  
 H 900 mm



Art. 148/1  
 Ø 30 mm  
 H 900 mm



Art. 149/1  
 Ø 30 mm  
 H 900 mm



Art. 149/2  
 Ø 30 mm  
 H 900 mm



Art. 537/8  
 Ø 30 mm  
 H 1000 mm



Art. 537/9  
 Ø 30 mm  
 H 1000 mm



**GROOVED PICKETS - PALETTI RIGATI**  
**TUBE-TUBO Ø 30 mm THICKN. - SPESS. 1,5 mm**



Art. 1231/1  
 Ø 30 mm  
 H 1000 mm



Art. 1229/1  
 Ø 30 mm  
 H 1000 mm



Art. 1231/2  
 Ø 30 mm  
 H 1000 mm



Art. 1229/2  
 Ø 30 mm  
 H 1000 mm



Art. 1229/4  
 Ø 30 mm  
 H 1000 mm



Art. 1229/5  
 Ø 30 mm  
 H 1000 mm



Some Arteferro tubular pickets appear in the film "007 GoldenEye" (1995) directed by Martin Campbell

Alcuni paletti in tubo Arteferro appaiono nel film "007 GoldenEye" (1995) diretto da Martin Campbell



Art. 1794/10  
 Ø 30 x 1,5 mm  
 L 3000 mm

Art. 1794/10/6000  
 Ø 30 x 1,5 mm  
 L 6000 mm

PLAIN PICKETS - PALETTI LISCI

Tube pickets - Paletti in tubo

TUBE - TUBO Ø 30 mm THICKN. - SPESS. 1,5 mm

TUBE - TUBO Ø 40 mm THICKN. - SPESS. 2 mm



Art. 537/2  
Ø 30 mm  
H 1000 mm

Art. 537/1  
Ø 30 mm  
H 1000 mm

Art. 537/3  
Ø 30 mm  
H 1000 mm

Art. 146/1  
Ø 40 mm  
H 900 mm

Art. 146/4  
Ø 40 mm  
H 900 mm

Art. 145/3  
Ø 40 mm  
H 1000 mm

Art. 145/4  
Ø 40 mm  
H 1200 mm

GROOVED PICKETS - PALETTI RIGATI

TUBE-TUBO Ø 30 mm  
THICKN. - SPESS. 1,5 mm

TUBE-TUBO Ø 40 mm  
THICKN. - SPESS. 2 mm



Art. 1230/2  
Ø 30 mm  
H 1000 mm

Art. 1230/4  
Ø 30 mm  
H 1000 mm

Art. 1229/3  
Ø 30 mm  
H 1000 mm

Art. 1794/3  
Ø 40 mm  
H 1000 mm

Art. 1794/4  
Ø 40 mm  
H 1000 mm

Art. 1794/5  
Ø 40 mm  
H 1000 mm

Art. 1794/6  
Ø 40 mm  
H 1200 mm

Art. 1794/9  
Ø 40 x 2 mm  
L 3000 mm  
Art. 1794/9/6000  
Ø 40 x 2 mm  
L 6000 mm

Pickets with twisting - Paletti con torciglione

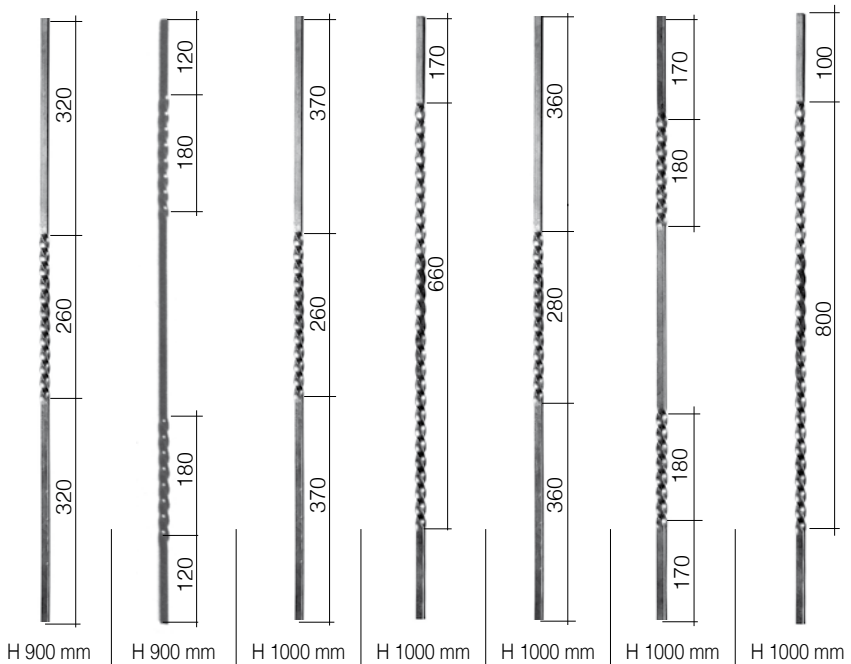

Sec.Sez.	Finish - Finitura	Art.	Art.	Art.	Art.	Art.	Art.	Art.
Φ 12 mm	Plain Liscio	65/8	53/3	-	1148/2	1148/5	1148/8	-
	Bark effect Corteccia	-	-	-	1148/11	1148/14	1148/17	-
	Grooved Rigato	118/H/2	118/H/1	118/H/30	1151/7	1151/5	1151/6	1723/3
Φ 14 mm	Plain Liscio	70/D/3	70/D/2	-	1148/3	1148/6	1148/9	-
	Bark effect Corteccia	-	-	-	1148/12	1148/15	1148/18	-
	Grooved Rigato	-	-	-	-	-	-	1723/4

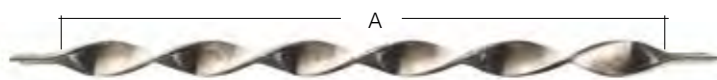

Section Sezione	Finish - Finitura	H 720 mm A = 520 mm	H 820 mm A = 620 mm	H 900 mm A = 700 mm	H 1200 mm A = 900 mm
		Art.	Art.	Art.	Art.
16 x 4 mm	Plain Liscio	119/4	119/11	119/18	-
20 x 4 mm		119/5	119/12	119/19	-
20 x 6 mm		119/6	119/13	119/20	-
30 x 8 mm		-	-	118/H/3	118/H/4

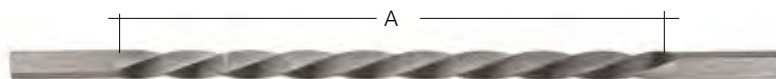

Section Sezione	Finish - Finitura	H 720 mm A = 520 mm	H 820 mm A = 620 mm	H 900 mm A = 700 mm
		Art.	Art.	Art.
Φ 12 x 12 mm	Plain - Plain	119/9	119/16	119/23
Φ 14 x 14 mm		119/10	119/17	119/24



**TWISTS WITH TRIPLE TWISTING  
TORCIGLIONI CON TRIPLA ATTORCIGLIATURA**













**i** Arteferro products can be manufactured as well as customised.  
I prodotti Arteferro sono realizzabili anche su misura.

Sec.Sez.	Finish - Finitura	Art.	H 900 mm Art.	H 1000 mm Art.	H 1200 mm Art.
Ø 12 mm	Plain Liscio 	GD106/1	GD106/4	GD106/7	
	Four-leaf clover Quadrifoglio 	GD106/10	GD106/13	GD106/16	
	Grooved Rigato 	GD106/19	GD106/22	GD106/25	
Ø 14 mm	Plain Liscio 	GD106/2	GD106/5	GD106/8	
	Four-leaf clover Quadrifoglio 	GD106/11	GD106/14	GD106/17	
	Grooved Rigato 	GD106/20	GD106/23	GD106/26	
Ø 16 mm	Plain Liscio 	GD106/3	GD106/6	GD106/9	
	Four-leaf clover Quadrifoglio 	GD106/12	GD106/15	GD106/18	
	Grooved Rigato 	GD106/21	GD106/24	GD106/27	



Newel Post - Caposaldo

						
		H 1200 mm	H 1200 mm	H 1200 mm	H 1200 mm	H 1000 mm
Sezione	Finish - Finitura	Art.	Art.	Art.	Art.	Art.
Ø 20 mm	Plain Liscio 	-	113/7	-	119/25	1751/5
Ø 25 mm	Beveled Smussato 	112/3	-	-	-	-
Ø 30 mm	Beveled Smussato 	112/4	-	-	-	-
Ø 25 mm	Plain Liscio 	-		GD22/6/S	119/26	-
Ø 30 mm	Plain Liscio 	-	113/8	GD22/6	119/27	-

Pickets with twisting - Paletti con torciglione

Plain - Liscio

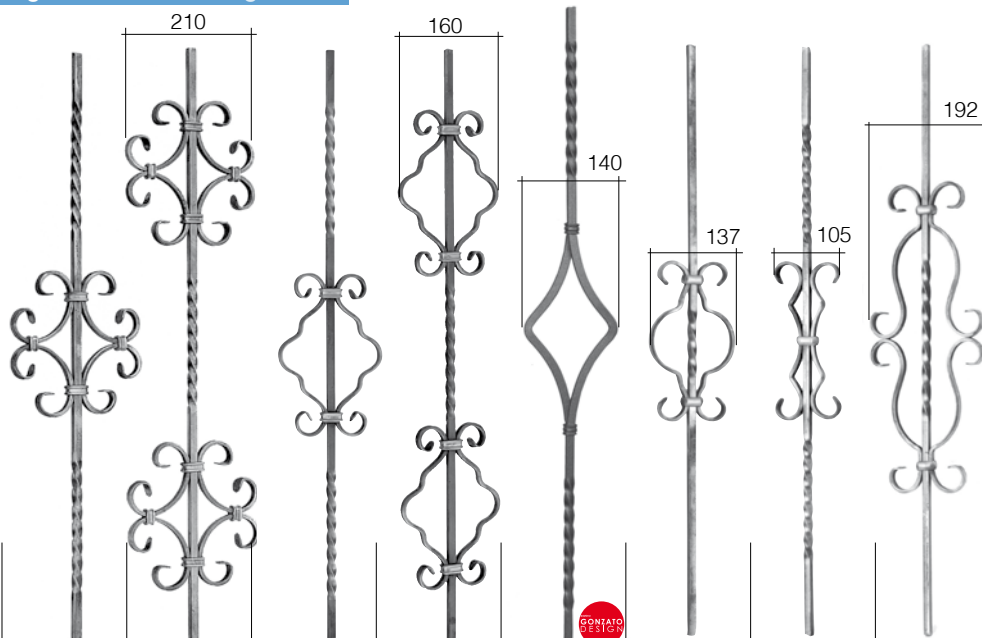

Sec.Sez.	Finish - Finitura	Art.	Art.	Art.	Art.	Art.	Art.	Art.	Art.
∅ 12 mm	Plain Liscio	584/1	584/2	1127/1	1127/2	GD275/5	64/E/1	64/E/2	64/E/3



Pag. 36

Large choice of twisted bars 3m long

Ampia scelta di barre attorcigliate 3 mt.

Plain - Liscio

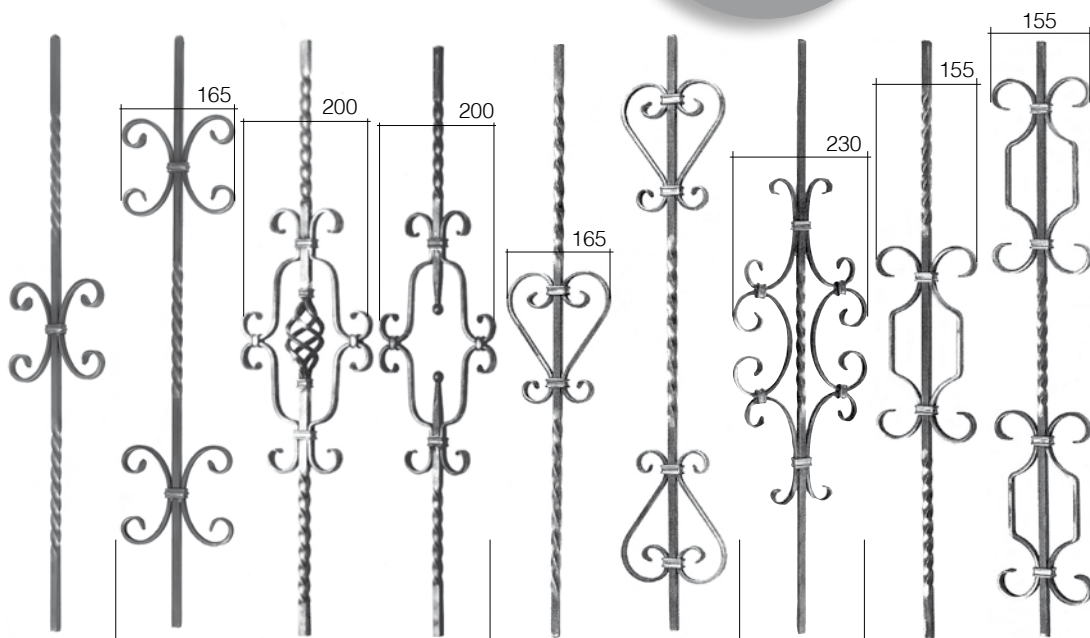

Sec.Sez.	Finish - Finitura	Art.	Art.	Art.	Art.	Art.	Art.	Art.	Art.	Art.
∅ 12 mm	Plain Liscio	584/4	584/5	64/B/2	64/A/3	584/B/2	584/B/1	584/A/6	584/A/5	584/A/4
∅ 14 mm	Plain Liscio	-	-	64/B/5	64/A/7	-	-	-	-	-

Pickets with twisting - Paletti con torciglione

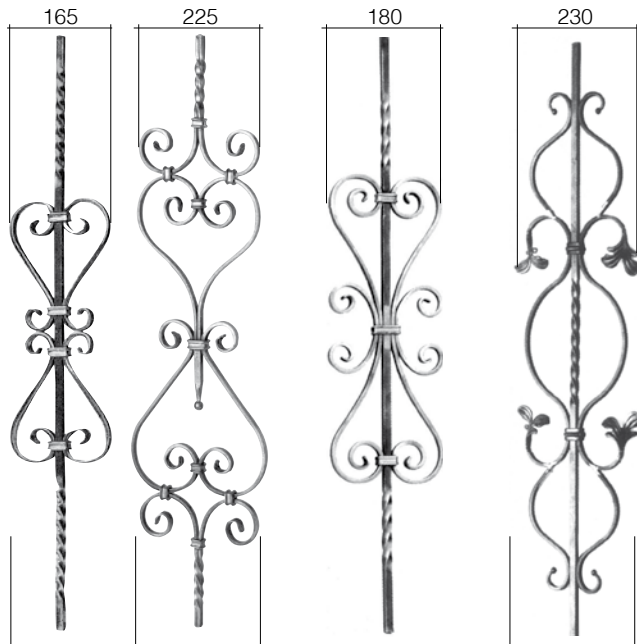

H 900 mm   H 1000 mm   H 900 mm   H 1000 mm   H 1000 mm

Sec.Sez.	Finish - Finitura	Art.	Art.	Art.	Art.	Art.
Φ 12 mm	Plain Liscio 	584/B/3	1124/1	49/3	1753/1	52/A/2

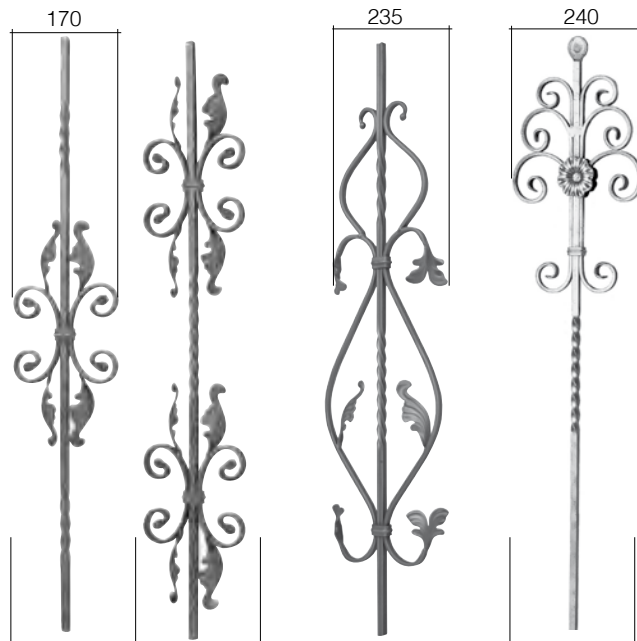

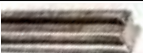

H 900 mm   H 900 mm   H 900 mm   H 1000 mm   H 1000 mm

Sec.Sez.	Finish - Finitura	Art.	Art.	Art.	Art.	Art.
Φ 12 mm	Plain Liscio 	52/A/3	52/A/5	-	-	1124/2
Φ 12 mm	Grooved Rigato 	-	-	52/2	1753/7	-

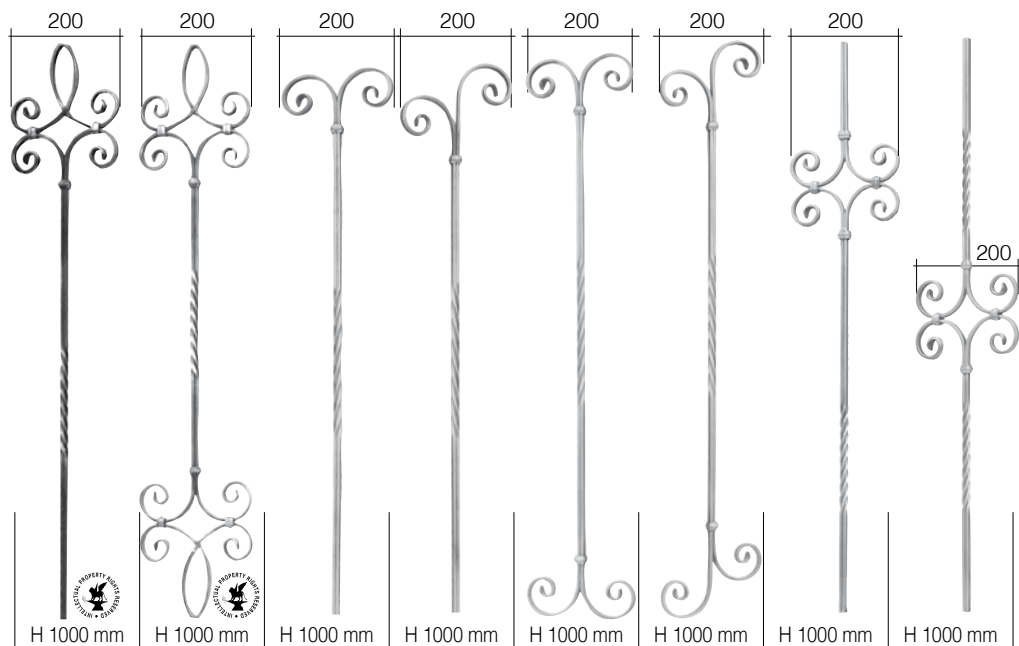

Grooved - Rigato



Sec.Sez.	Finish - Finitura	Art.	Art.	Art.	Art.	Art.	Art.	Art.	Art.
Φ 12 mm	Grooved Rigato 	1688/4	1688/3	1695/1	1695/2	1695/3	1695/4	1695/5	1695/6



Pickets with twisting - Paletti con torciglione

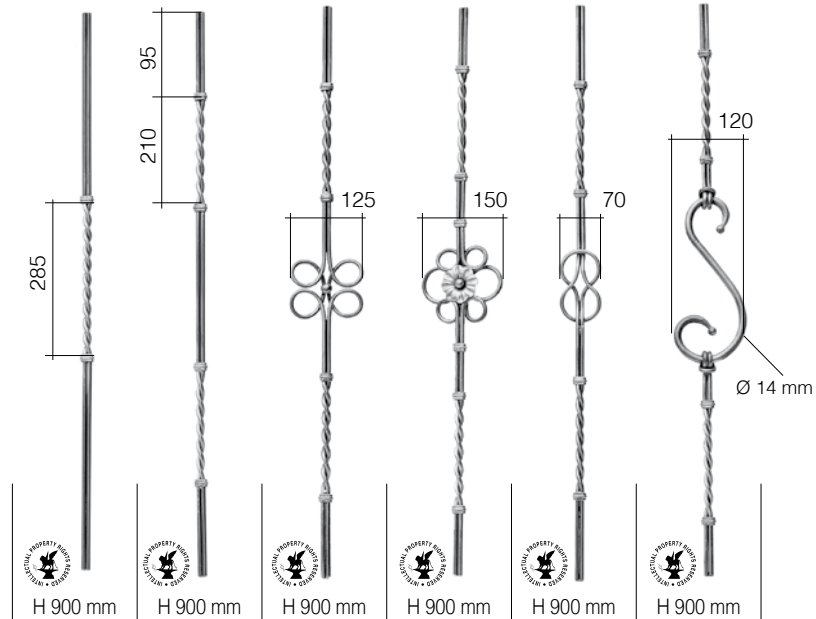
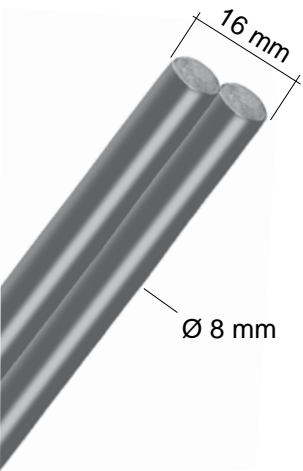

Sec.Sez.	Finish - Finitura	Art.	Art.	Art.	Art.	Art.	Art.
Ø 8 mm	Plain Liscio	617/7	617/6	615/3	615/1	615/4	617/5

BEST PRICE

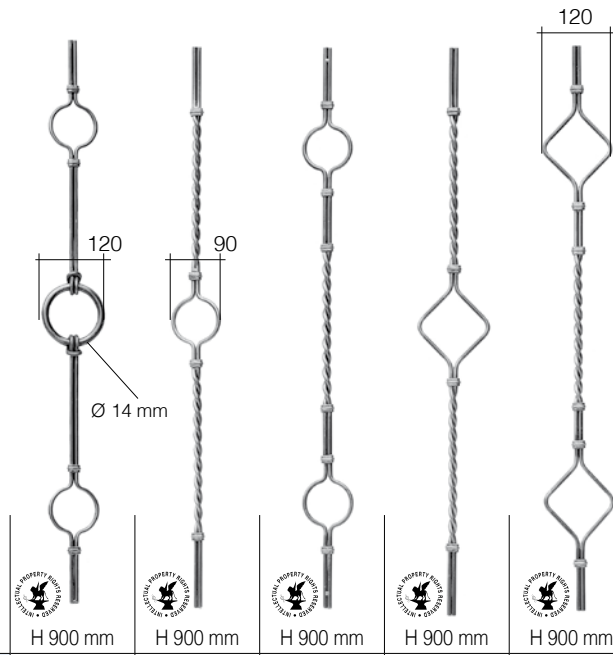
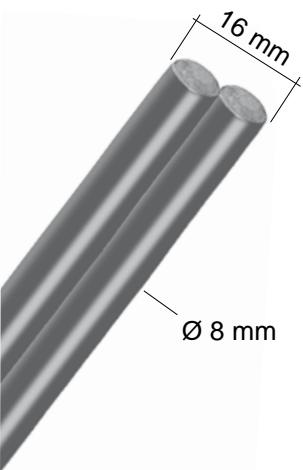

Sec.Sez.	Finish - Finitura	Art.	Art.	Art.	Art.	Art.
Ø 8 mm	Plain Liscio	615/2	617/1	617/2	617/3	617/4



Not all of the Arterferro items are available in Arterferro Quick, just a special selection. Find out about the entire range in the catalogue

In Arterferro Quick non sono presenti tutti gli articoli Arterferro, ma solo una speciale selezione. Scopri la gamma completa nel catalogo

*Compendium*

Pickets with big twisting - Paletti con torciglione grande

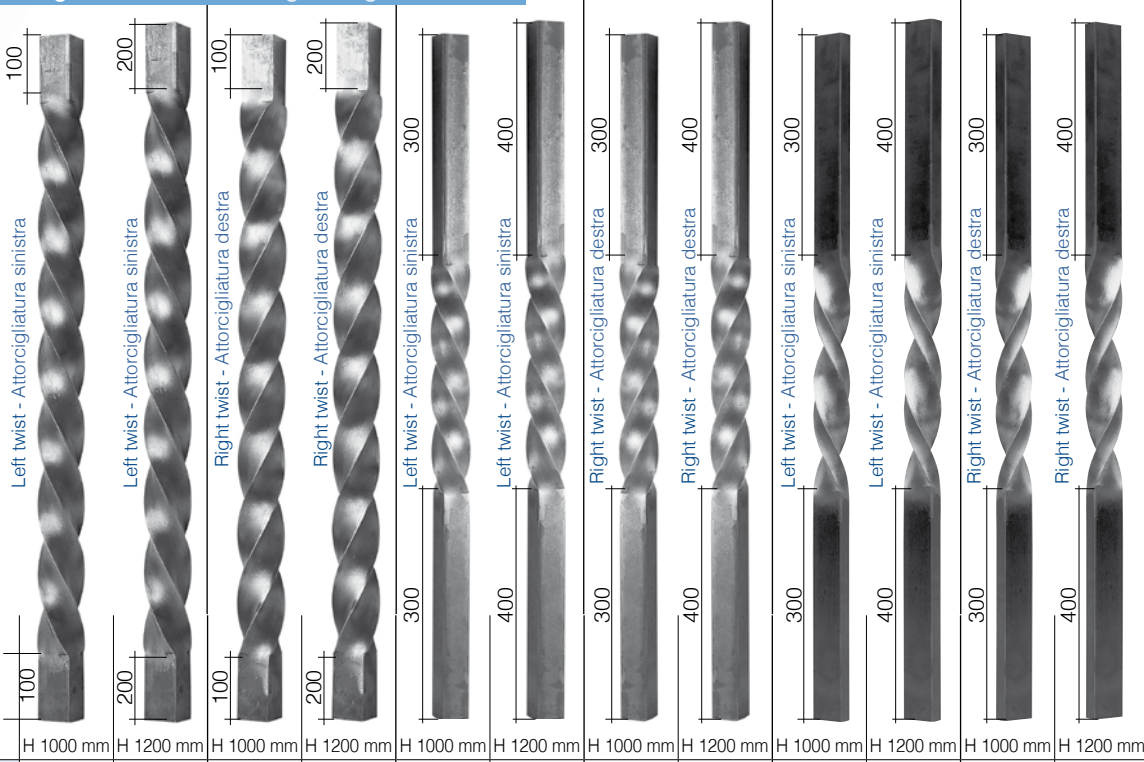

Sec.Sez.	Finish - Finitura	Art.	Art.	Art.	Art.	Art.	Art.	Art.	Art.	Art.	Art.	Art.	Art.
Ø 30 mm	Plain Liscio	119/27	1724/20	1724/25	1724/26	1724/31	1724/32	1724/37	1724/38	-	-	-	-
	Multiline Multiriga	1725/5	1725/6	1725/11	1725/12	1725/17	1725/18	1725/23	1725/24	-	-	-	-
	Grooved Rigato	1724/43	1724/44	1724/49	1724/50	1724/55	1724/56	1724/61	1724/62	-	-	-	-
Ø 40 mm	Plain Liscio	119/28	1724/19	1724/23	1724/24	1724/29	1724/30	1724/35	1724/36	-	-	-	-
	Multiline Multiriga	1725/3	1725/4	1725/9	1725/10	1725/15	1725/16	1725/21	1725/22	-	-	-	-
	Grooved Rigato	1724/41	1724/42	1724/47	1724/48	1724/53	1724/54	1724/59	1724/60	-	-	-	-
Ø 50 mm	Plain Liscio	1724/17	1724/18	1724/21	1724/22	1724/27	1724/28	1724/33	1724/34	-	-	-	-
	Multiline Multiriga	1725/1	1725/2	1725/7	1725/8	1725/13	1725/14	1725/19	1725/20	-	-	-	-
	Grooved Rigato	1724/39	1724/40	1724/45	1724/46	1724/51	1724/52	1724/57	1724/58	-	-	-	-
Ø 50 x 25 mm	Plain Liscio	1724/3	1724/4	1724/7	1724/8	-	-	-	-	1724/11	1724/12	1724/15	1724/16
Ø 60 x 30 mm	Plain Liscio	1724/1	1724/2	1724/5	1724/6	-	-	-	-	1724/9	1724/10	1724/13	1724/14











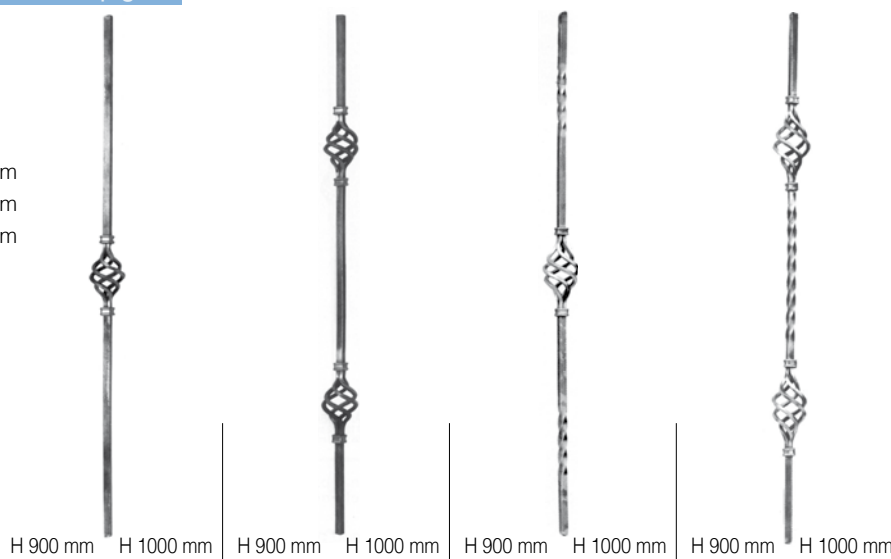

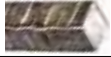

Pickets with baskets - Paletti con pigna

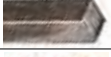

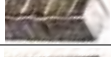
159/3  $\varnothing$  12 mm  
 159/4  $\varnothing$  14 mm  
 159/5  $\varnothing$  16 mm



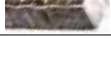

Sec.Sez.	Finish - Finitura	Art.	Art.	Art.	Art.	Art.	Art.	Art.	Art.
$\varnothing$ 12 mm	Plain Liscio 	48/A/2	-	48/A/1	-	48/2	-	48/1	-
	Hammered Spigolato 	48/4	-	48/3	-	-	-	-	-
	Hammered Martellato 	48/A/4	-	48/A/3	-	-	-	-	-
	Grooved Rigato 	-	1151/3	-	1151/4	-	1151/1	-	1151/2
	Bark effect Corteccia 	-	1733/18	-	1733/17	-	-	-	-
$\varnothing$ 14 mm	Plain Liscio 	-	-	48/A/5	-	48/7	-	48/6	-
	Hammered Spigolato 	48/9	-	48/8	-	-	-	-	-
	Hammered Martellato 	48/A/8	-	48/A/7	-	-	-	-	-
	Bark effect Corteccia 	-	1733/20	-	1733/19	-	-	-	-
$\varnothing$ 16 mm	Plain Liscio 	-	-	48/A/9	-	48/12	-	48/11	-
	Hammered Spigolato 	48/14	-	48/13	-	-	-	-	-
	Hammered Martellato 	48/A/12	-	48/A/11	-	-	-	-	-

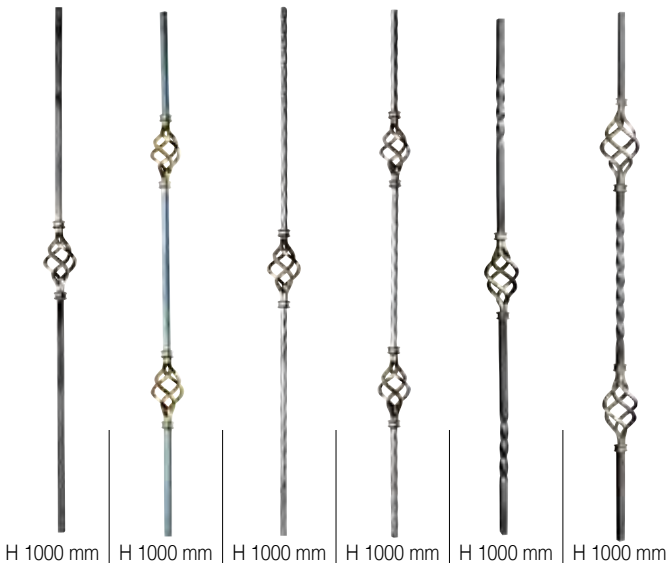

1466/12

brass-ottone

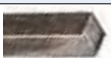



Sec.Sez.	Finish - Finitura	Art.	Art.	Art.	Art.	Art.	Art.
$\varnothing$ 12 mm	Plain Liscio 	1149/1	1149/2	-	-	1149/5	1149/6
	Hammered Spigolato 	-	-	1149/3	1149/4	-	-

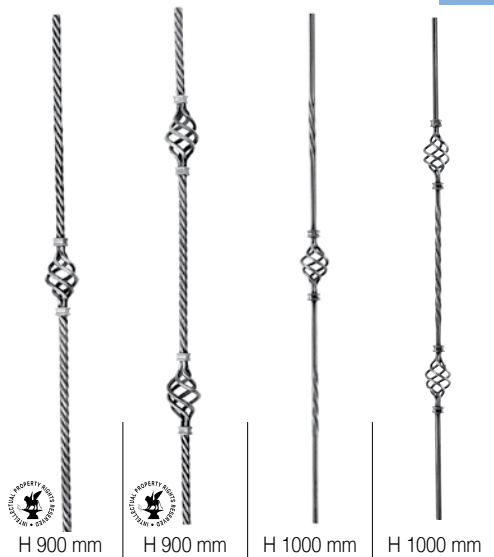

Pickets with baskets - Paletti con pigna



Sec.Sez.	Finish - Finitura	Art.	Art.	Art.	Art.
∅ 12 mm	Bark effect Corteccia 	462/1	462/2	1150/3	1150/4
∅ 14 mm	Bark effect Corteccia 	-	-	1150/7	1150/8

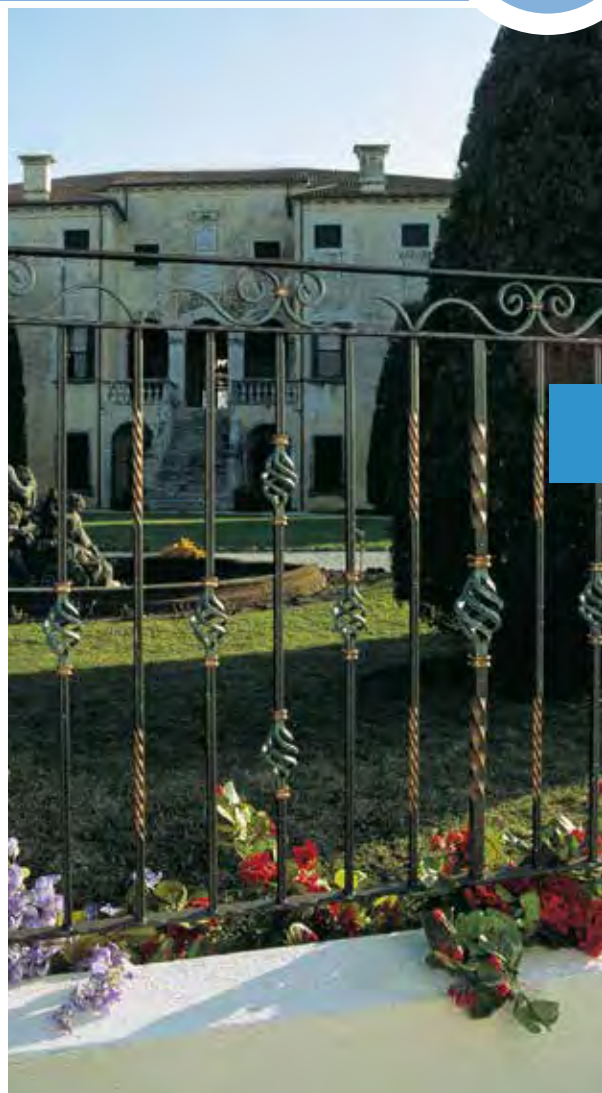





Pag. 229

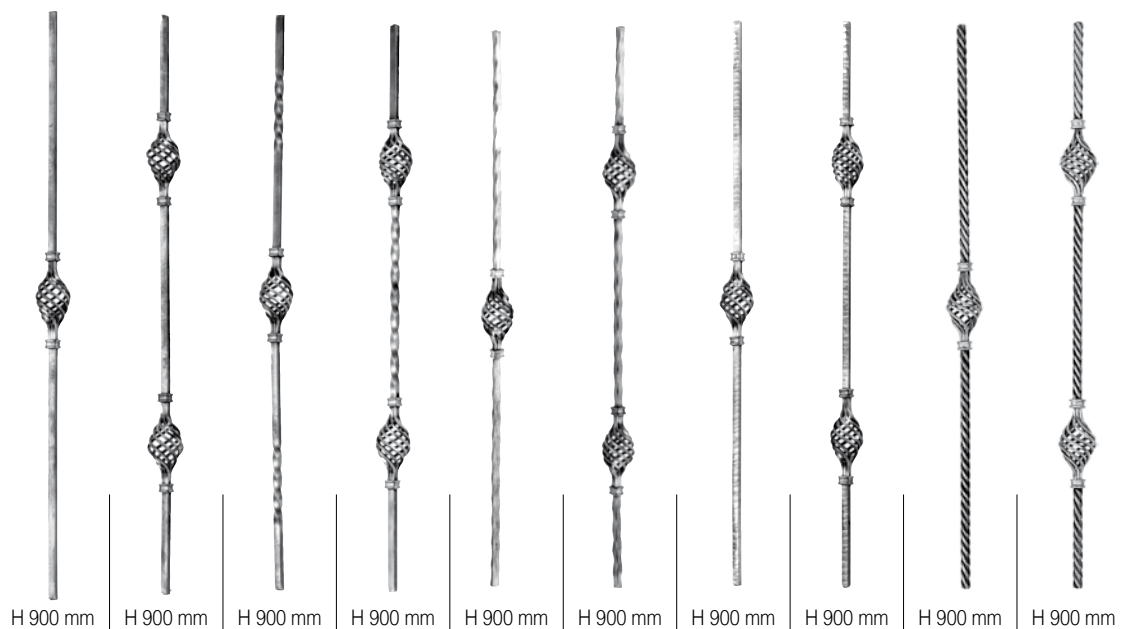
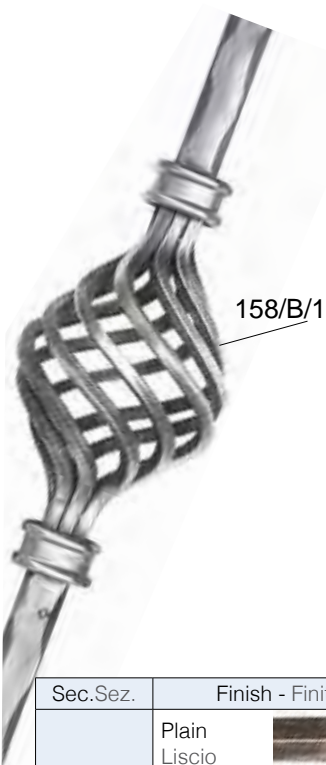





See also the Basket section

Vedi anche il capitolo Pigna







Sec.Sez.	Finish - Finitura	Art.	Art.	Art.	Art.	Art.	Art.	Art.	Art.	Art.	Art.
∅ 12 mm	Plain Liscio 	48/B/6	48/B/5	48/B/4	48/B/3	-	-	-	-	-	-
	Hammered Spigolato 	-	-	-	-	48/B/2	48/B/1	-	-	-	-
	Hammered Martellato 	-	-	-	-	-	-	48/B/8	48/B/7	-	-
	Bark effect Corteccia 	-	-	-	-	-	-	-	-	-	462/3

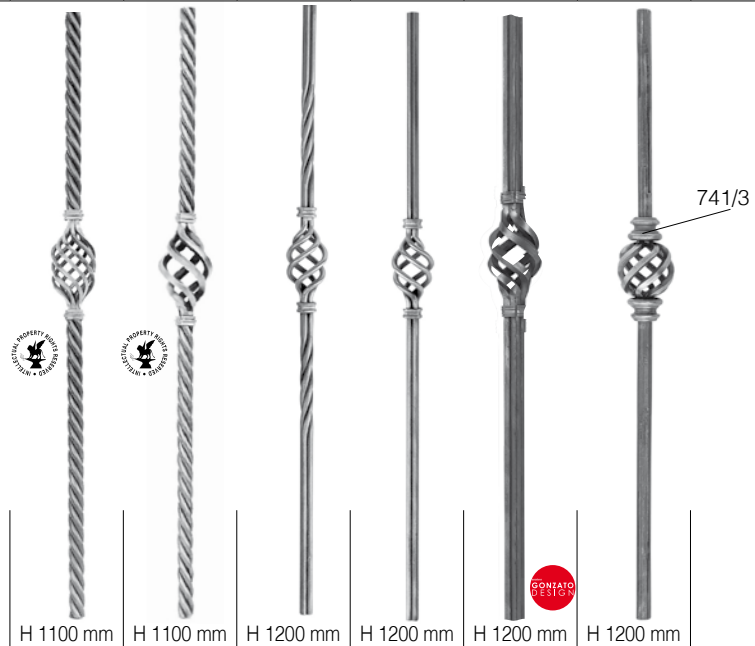

Sec.Sez.	Finish - Finitura	Art.	Art.	Art.	Art.	Art.	Art.	Art.	Art.
Ø 20 mm	Plain Liscio 	113/1	112/B/15	112/B/9	-	-	-	1149/7	-
	Hammered Spigolato 	-	-	-	-	113/3	112/B/13	-	1149/8
	Hammered Martellato 	-	-	-	112/B/11	-	-	-	-
Ø 30 mm	Plain Liscio 	113/2	112/B/16	112/B/10	-	-	-	-	-
	Hammered Spigolato 	-	-	-	-	113/4	112/B/14	-	-
	Hammered Martellato 	-	-	-	112/B/12	-	-	-	-

**i** Arterferro products can be manufactured as well as customised.  
I prodotti Arterferro sono realizzabili anche su misura.



Sezione	Finish - Finitura	Art.	Art.	Art.	Art.	Art.	Art.
Ø 30 mm	Grooved Rigato 	-	-	-	-	GD13/1	-
Ø 24 mm	Four-leaf clover Quadrifoglio 	-	-	1203/2	1203/1	-	-
Ø 30 mm	Four-leaf clover rope Quadrifoglio fune 	801/3	801/4	-	-	-	-
Ø 30 mm	Power hamm. Magliato 	-	-	-	-	-	1204/1

Scrolls with forged ends - Riccioli con terminali fucinati

"S" shaped panels - Pannelli ad "S"



Art. 24/F/1  
 Ø 12 x 12 mm  
 300 x 560 mm



Art. 1050/4  
 Ø 12 mm  
 265 x 640 mm



Art. 1050/3  
 Ø 14 x 14 mm  
 265 x 720 mm



Art. 540/2  
 Ø 12 mm  
 250 x 720 mm



Art. 62/1  
 20 x 6 mm  
 235 x 720 mm  
 Art. 1050/1  
 20 x 6 mm  
 235 x 720 mm

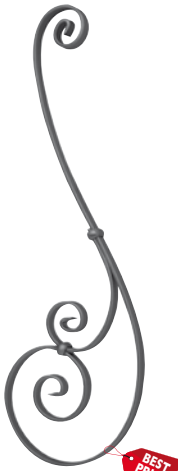

Art. 62/2  
 20 x 6 mm  
 235 x 720 mm



Art. 63/4  
 20 x 6 mm  
 235 x 820 mm



Art. 1045/7  
 Ø 12 x 12 mm  
 250 x 770 mm



Art. 1045/8  
 Ø 12 x 12 mm  
 250 x 770 mm



Art. 1045/5  
 Ø 12 x 12 mm  
 250 x 770 mm



Art. 1045/6  
 Ø 12 x 12 mm  
 250 x 770 mm



Art. 1046/1  
 Ø 12 x 12 mm  
 250 x 900 mm



Art. 1046/2  
 Ø 12 x 12 mm  
 200 x 900 mm

"S" shaped panels - Pannelli ad "S"



Art. 1051/4  
 ∅ 12 x 6 mm  
 150 x 400 mm  
 Plain - Liscio



Art. 1671/6  
 ∅ 12 x 6 mm  
 190 x 435 mm  
 Plain - Liscio



Art. 1051/5  
 ∅ 12 x 6 mm  
 185 x 600 mm  
 Plain - Liscio



Art. 52/1  
 ∅ 12 x 6 mm  
 350 x 870 mm  
 Plain - Liscio

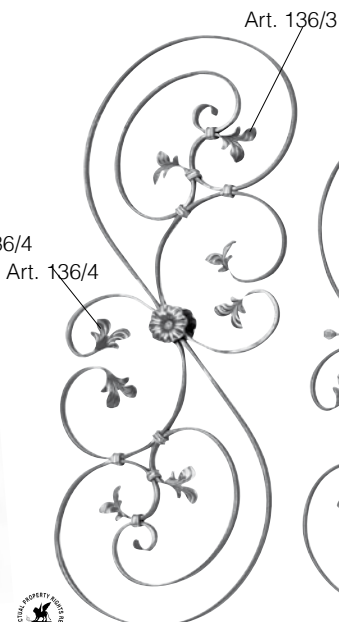

\* Art. 1670/1  
 ∅ 12 x 6 mm  
 360 x 1000 mm  
 Plain - Liscio



\* Art. 1670/2  
 ∅ 12 x 6 mm  
 350 x 870 mm  
 Plain - Liscio

\*Rosettes 116/A/4 on both sides

\*Rosette 116/A/4 sui 2 lati



Pag. 233

Do you need wrought iron leaves? Go to section 15 Flowers and Rosettes

Hai bisogno di foglie in ferro battuto? Vai al capitolo 15 Fiori e Rosette

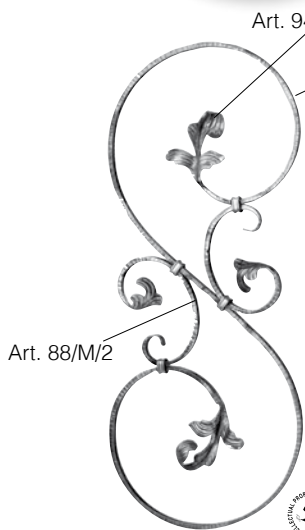

Art. 52/G/1  
 ∅ 16 x 8 mm  
 370 x 870 mm  
 Notched  
 Tacchettato

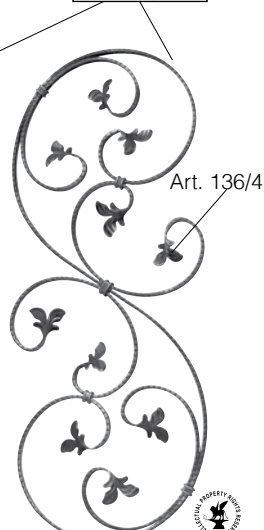

Art. 1671/3  
 ∅ 12 x 6 mm  
 350 x 870 mm  
 Notched  
 Tacchettato



Art. 1671/4  
 ∅ 12 x 6 mm  
 350 x 870 mm  
 Hammered  
 Spigolato



Art. 541/1  
 ∅ 12 x 12 mm  
 370 x 900 mm  
 Hammered  
 Spigolato



Art. 1671/1  
 ∅ 12 x 12 mm  
 350 x 900 mm  
 Hammered  
 Spigolato

Art. 541/2  
 ∅ 14 mm  
 340 x 900 mm  
 Plain  
 Liscio

Art. 1671/2  
 ∅ 12 mm  
 350 x 900 mm  
 Plain  
 Liscio

Hot forged end scrolls - Riccioli terminali fucinati a caldo

"S" shaped panels - Pannelli ad "S"



Art. 681/2  
 □ 16 x 8 mm  
 270 x 600 mm



Art. 681/1  
 □ 16 x 8 mm  
 270 x 600 mm



Art. 685/4  
 Ø 12 mm  
 240 x 590 mm



Art. 685/3  
 Ø 12 mm  
 240 x 590 mm



Art. 685/2  
 Ø 12 mm  
 320 x 740 mm



Art. 685/1  
 Ø 12 mm  
 320 x 740 mm



Art. 681/3  
 □ 16 x 8 mm  
 320 x 740 mm



Art. 681/4  
 □ 16 x 8 mm  
 320 x 740 mm



Art. 685/6  
 Ø 12 mm  
 360 x 810 mm



Art. 685/5  
 Ø 12 mm  
 360 x 810 mm

"S" shaped panels - Pannelli ad "S"

**i** Arterferro products can be manufactured as well as customised. I prodotti Arterferro sono realizzabili anche su misura.

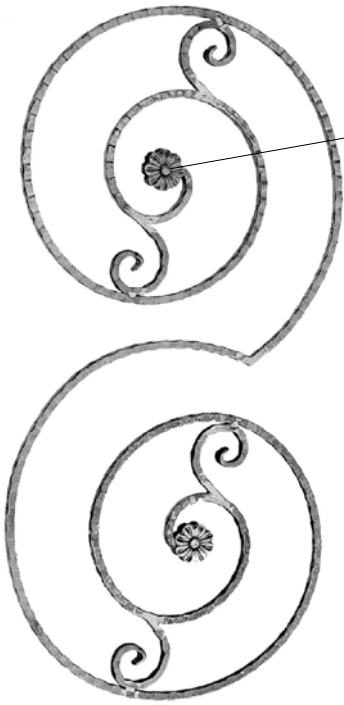

Art. 697/4 on both sides  
Art. 697/4 su entrambi i lati

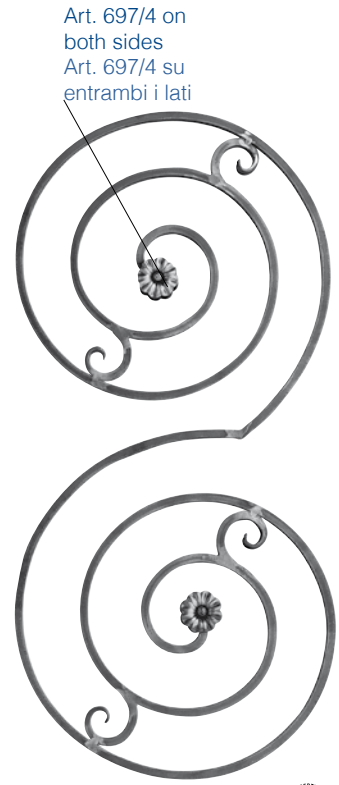

Art. 697/4 on both sides  
Art. 697/4 su entrambi i lati

Art. 483/1  
Φ 14 x 14 mm  
540 x 1100 mm  
power hammered  
magliato

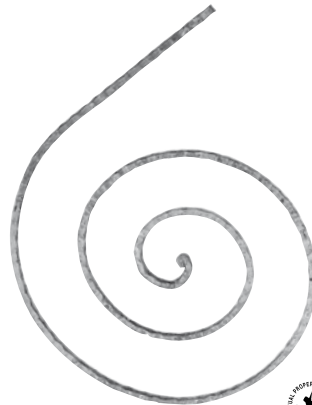

Art. 483/2  
Φ 14 x 14 mm  
550 x 700 mm  
power hammered  
magliato

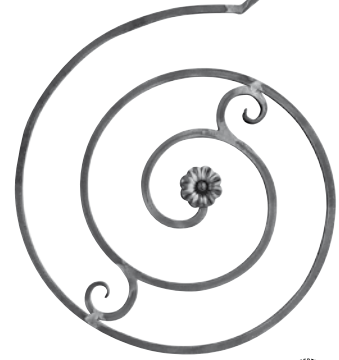

Art. 1038/1  
Φ 14 x 14 mm  
510 x 1080 mm  
plain - liscio

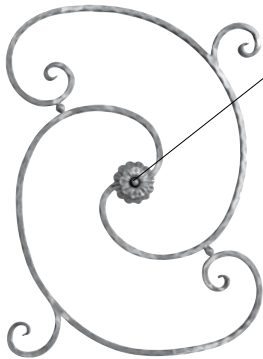

Art. 697/3 on both sides  
Art. 697/3 su entrambi i lati

Art. 1040/1  
Φ 14 x 14 mm  
570 x 760 mm  
hammered - spigolato



Art. 1039/1  
Φ 14 x 14 mm  
570 x 760 mm  
hammered - spigolato

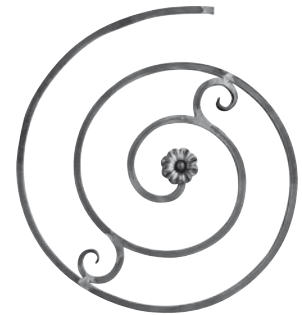

Art. 1038/2  
Φ 14 x 14 mm  
510 x 560 mm  
plain - liscio



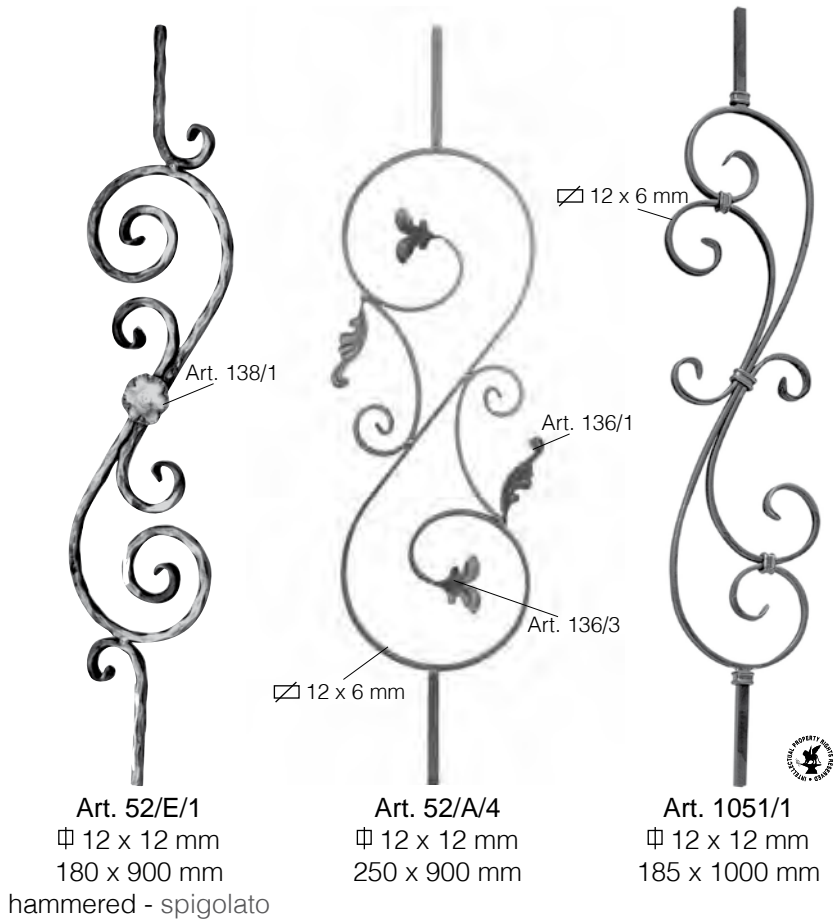
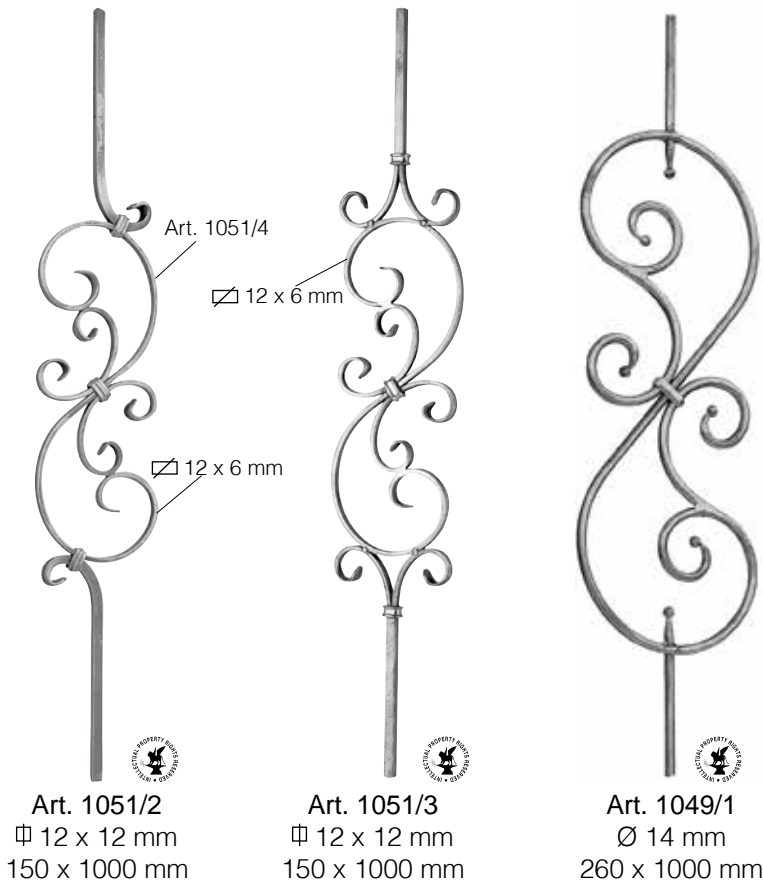



Art. 510/1  
 Ø 12 x 12 mm  
 250 x 900 mm



Art. 511/1  
 Ø 12 x 12 mm  
 125 x 900 mm

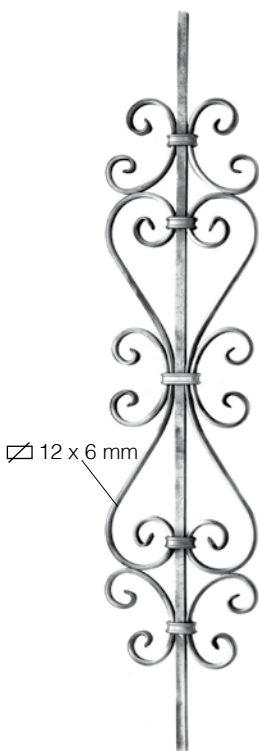

Art. 52/E/2  
 Ø 12 x 12 mm  
 185 x 900 mm



Art. 59/1  
 Ø 20 x 4 mm  
 170 x 830 mm



Art. 58/3  
 Ø 8 x 8 mm  
 160 x 900 mm

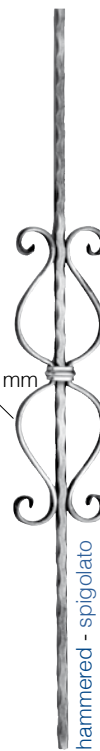

Art. 102/4  
 Ø 12 x 12 mm  
 110 x 900 mm

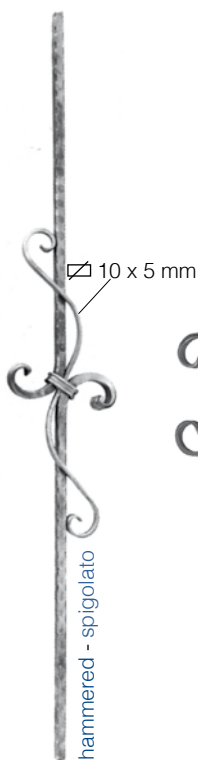

Art. 49/4  
 Ø 12 x 12 mm  
 125 x 900 mm  
 Art. 1753/2  
 Ø 12 x 12 mm  
 125 x 1000 mm



Art. 584/6  
 Ø 12 x 12 mm  
 165 x 900 mm

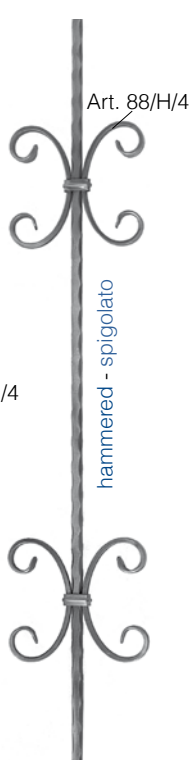

Art. 584/7  
 Ø 12 x 12 mm  
 165 x 900 mm



Art. 134/G/1  
 Ø 12 x 12 mm  
 140 x 900 mm

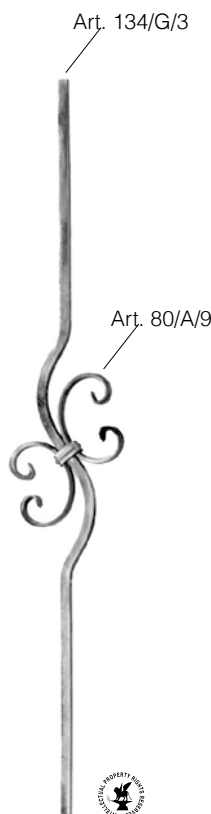

Art. 134/G/2  
 Ø 12 x 12 mm  
 140 x 900 mm



Art. 97/2  
 Ø 14 x 14 mm  
 130 x 830 mm



Art. 479/1  
 Ø 12 x 12 mm  
 110 x 900 mm  
 Art. 479/3  
 Ø 12 x 12 mm  
 110 x 1000 mm





Art. 70/E/8  
 Ø 14 x 14 mm  
 H 900 mm

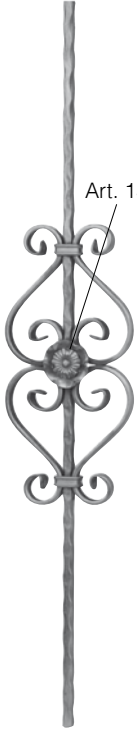

Art. 49/2  
 Ø 12 x 12 mm  
 165 x 900 mm  
 spigolato



Art. 53/2  
 Ø 12 x 12 mm  
 230 x 900 mm



Art. 539/2  
 Ø 12 x 12 mm  
 190 x 900 mm



Art. 487/1  
 Ø 16 x 8 mm  
 230 x 900 mm

676/2 on both sides - sui 2 lati



Art. 488/1  
 Ø 16 x 8 mm  
 190 x 900 mm



Rosette 116/A/4 on both sides - sui 2 lati

Art. 1678/2  
 Ø 14 x 8 mm  
 205 x 1000 mm

Hollow spheres - Sfere vuote  
 Ø 30 mm - Ø 40 mm



Art. 1064/1  
 Ø 12 mm  
 175 x 1000 mm



Art. 1064/2  
 Ø 12 mm  
 175 x 1000 mm



Art. 1064/3  
 Ø 12 mm  
 200 x 1000 mm



Art. 51/3  
 Ø 12 x 12 mm  
 300 x 900 mm

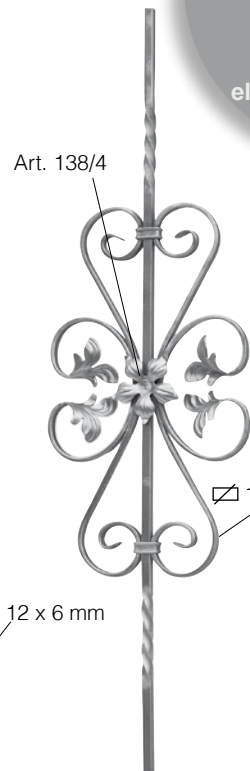

Art. 138/4

Ø 12 x 6 mm

Art. 1753/6  
 Ø 12 x 12 mm  
 260 x 1000 mm



Pag. 197

In section 11, scrolls and Snap-ons you'll find many items to match  
 Nel capitolo 11 Ricci e Snap-ons troverai tanti elementi da abbinare

Panels with scrolls - Pannelli con ricci

Rosette 116/A/4 on both sides - sui 2 lati



Art. 1647/3  
 12 x 6 mm  
 200 x 500 mm

Rosette 116/A/4 on both sides - sui 2 lati



Art. 473/1  
 12 x 12 mm  
 380 x 900 mm

Art. 1304/1



Art. 474/1  
 12 x 12 mm  
 380 x 755 mm

Art. 138/4 on both sides su 2 lati

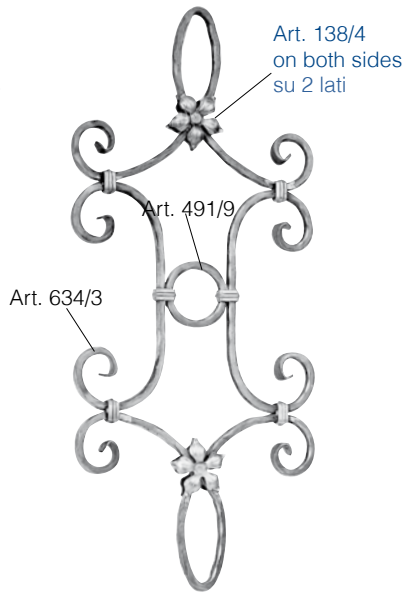

Art. 479/2  
 12 x 12 mm  
 385 x 900 mm

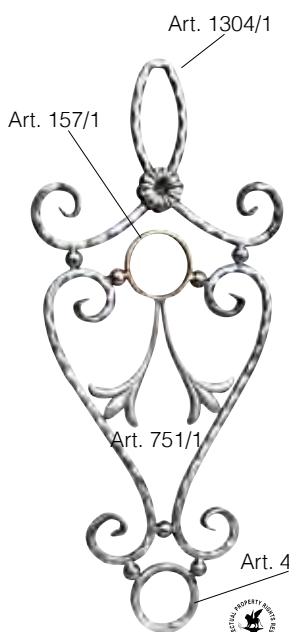

Art. 475/1  
 hammered - spigolato  
 12 x 12 mm  
 380 x 825 mm

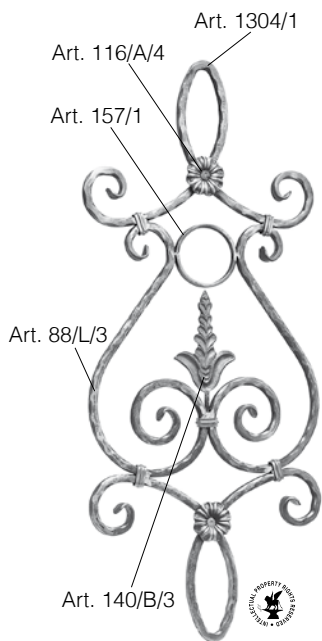

Art. 475/2  
 hammered - spigolato  
 12 x 12 mm  
 380 x 900 mm



Hot forged ends - Terminali fucinati a caldo

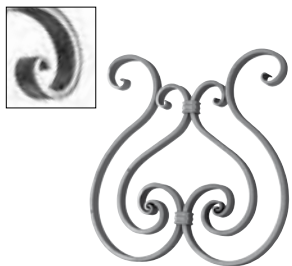

Art. NEW0011  
 16 x 6 mm  
 260 x 260 mm

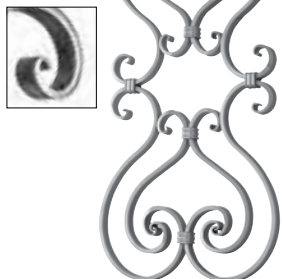

Art. NEW0009  
 16 x 6 mm  
 260 x 515 mm

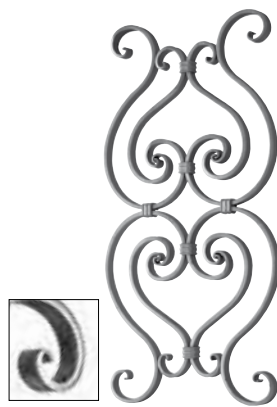

Art. GD270/5  
 16 x 6 mm  
 260 x 515 mm



Art. NEW0016  
 16 x 6 mm  
 175 x 510 mm



Arteferro pickets and panels are amongst the most important items in the composition of an infill of a balustrade or fence. The modern design of these new lines of items reinterprets in a contemporary way, the elegance and refinement of traditional materials like wrought iron.

I paletti e pannelli Arteferro sono tra gli elementi più importanti nella composizione del tamponamento di un parapetto o di una recinzione. Il design moderno di queste nuove linee di elementi reinterpreta in chiave contemporanea l'eleganza e la raffinatezza di un materiale tradizionale come il ferro battuto.

# PALETTI E PANNELLI MODERNI MODERN PICKETS AND PANELS

5. Modern pickets and Panels  
Paletti e Pannelli moderni



- A Geometric Style ..... pag.114
- B Linear Style ..... pag.120
- C Floreal Style ..... pag.129
- D Waves Style ..... pag.132
- E Impero Style ..... pag.135
- F Revolution Style ..... pag.137
- G New Classic Style ..... pag.141
- H New Liberty Style ..... pag.148

Most of the pickets and panels have been classified to make it easier for you to find the item you want quickly and easily. Starting with the central motif you can find your article with its finish and the matching decorations.

Molti paletti e pannelli sono stati classificati per dare la possibilità di trovare in modo veloce e pratico l'articolo desiderato. Parti dal motivo centrale troverai il tuo articolo con la lavorazione e i decori abbinabili.



Art. GD59/2  
 ∅ 12 x 12 mm  
 55 x 1000 mm  
 Art. GD59/2/Q14  
 ∅ 14 x 14 mm  
 55 x 1000 mm

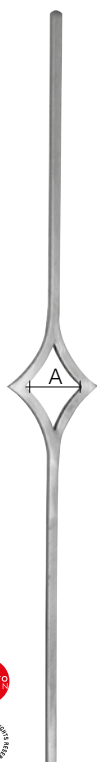

Art. GD23/1  
 ∅ 14 mm  
 120 x 1000 mm  
 A = 75 mm  
 Art. GD58/3 **BEST PRICE**  
 ∅ 12 mm  
 120 x 1000 mm  
 A = 80 mm

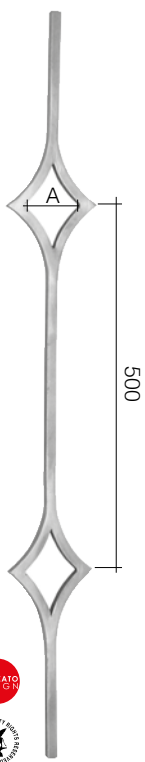

Art. GD25/1  
 ∅ 14 mm  
 120 x 1000 mm  
 A = 75 mm  
 Art. GD58/2  
 ∅ 12 mm  
 120 x 1000 mm  
 A = 80 mm



Art. GD19/1  
 ∅ 14 x 8 mm  
 100 x 1000 mm

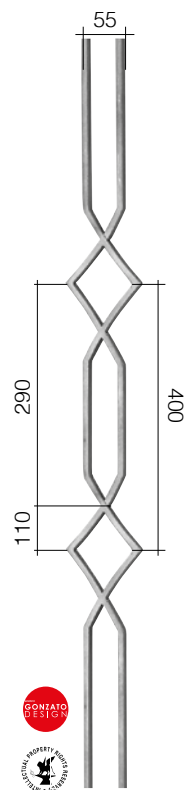

Art. GD19/2  
 ∅ 14 x 8 mm  
 100 x 1000 mm

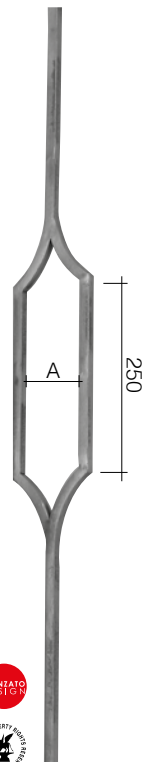

Art. GD25/3  
 ∅ 14 mm  
 110 x 1000 mm  
 A = 82 mm  
 Art. GD243/2  
 ∅ 12 mm  
 110 x 1000 mm  
 A = 86 mm

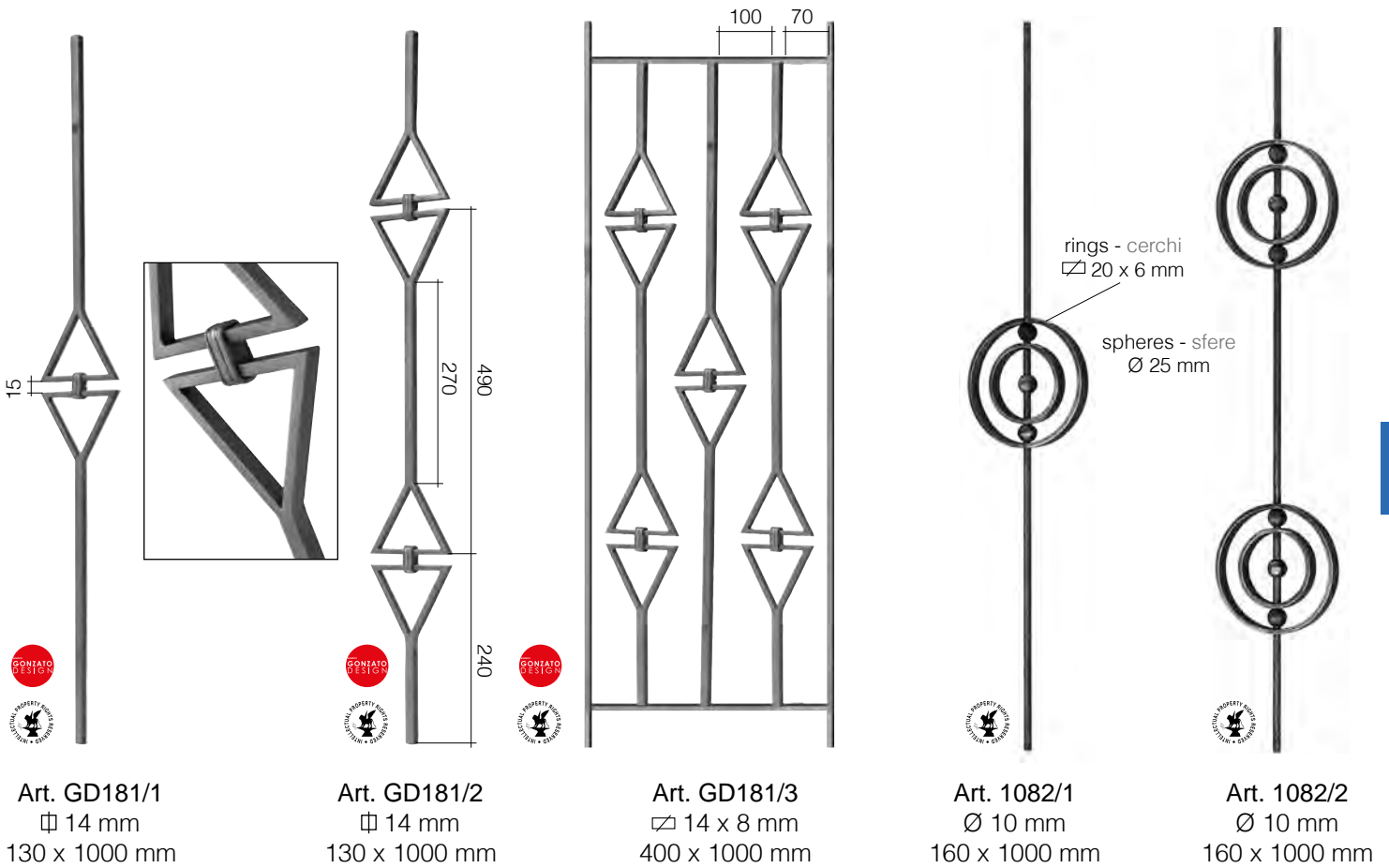

Ornaments - Ornamenti □ 14 x 8 mm

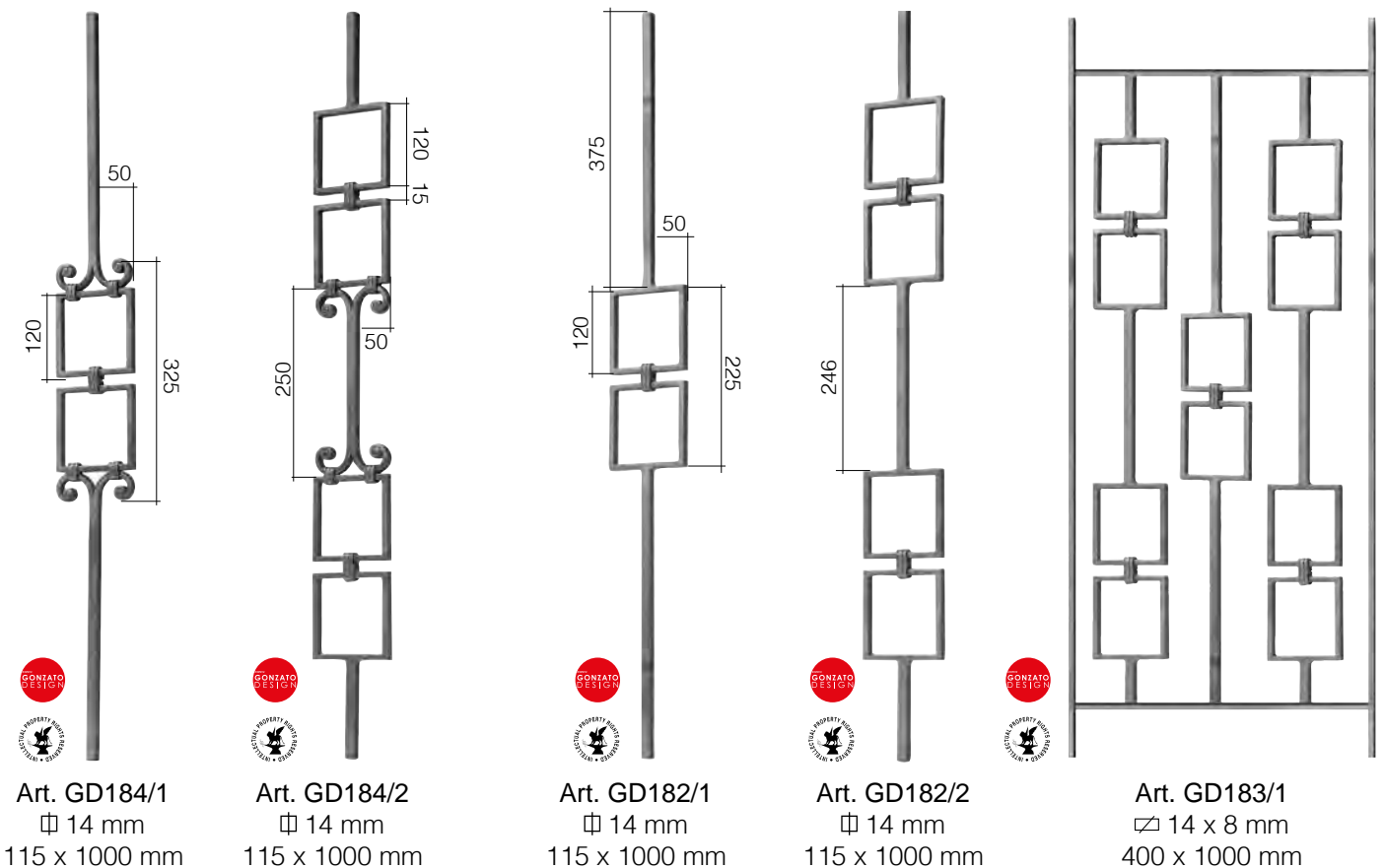

Geometric Style

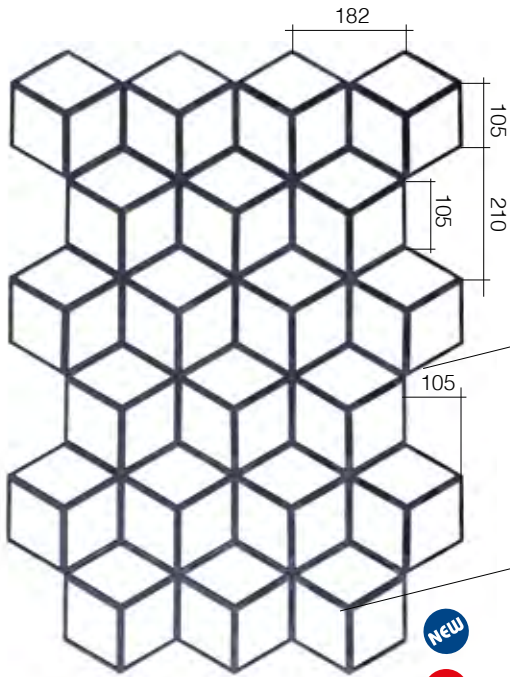

Art. GD287/1  
 $12 \times 6 \text{ mm} + \varnothing 12 \text{ mm}$   
 729 x 1000 mm

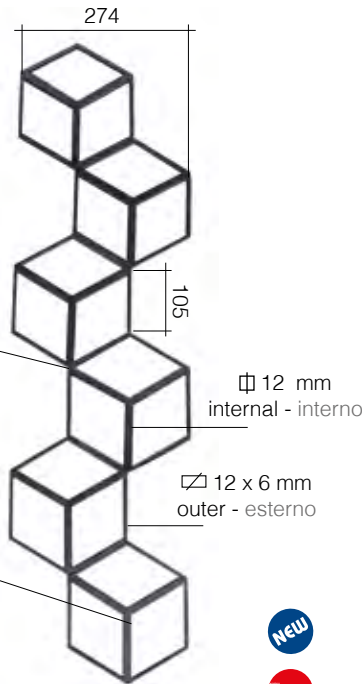

Art. GD287/2  
 $12 \times 6 \text{ mm} + \varnothing 12 \text{ mm}$   
 274 x 1000 mm

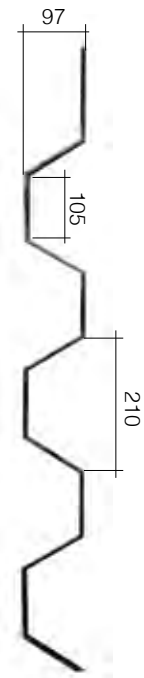

Art. GD287/3  
 $12 \times 6 \text{ mm}$   
 H 1000 mm

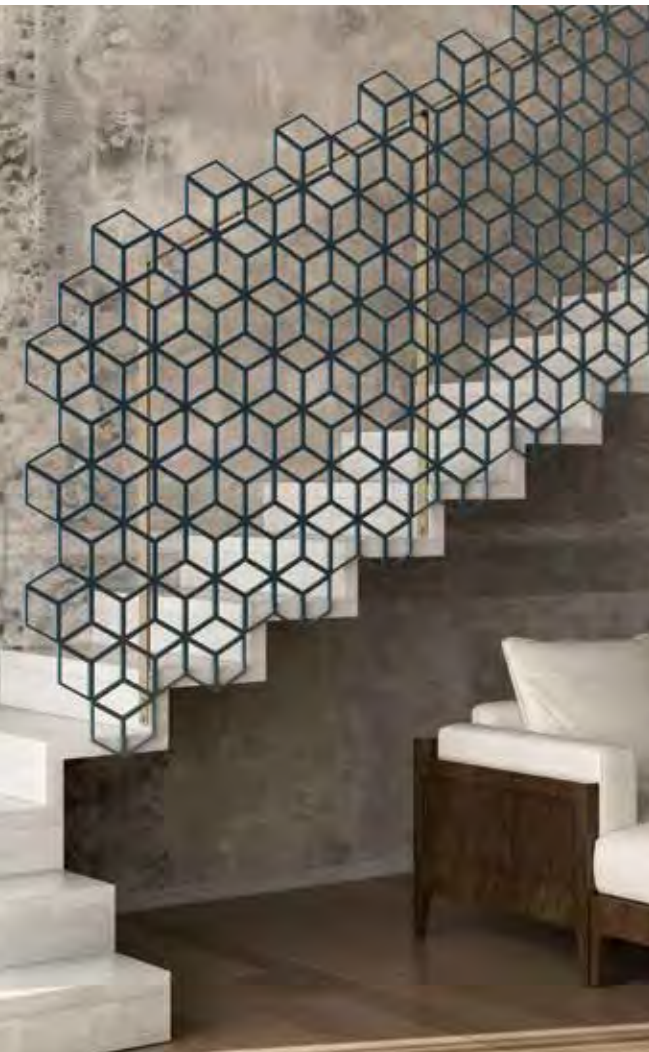

APPLICATION ON STAIRCASE  
 ESEMPIO DI MONTAGGIO SU SCALA

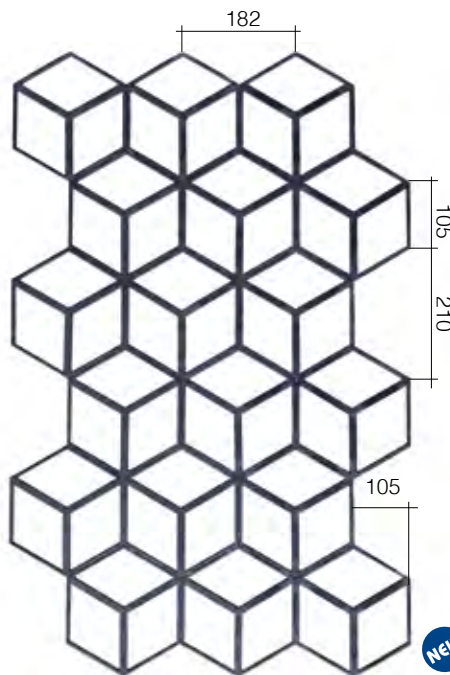

Art. GD287/4  
 $12 \times 6 \text{ mm} + \varnothing 12 \text{ mm}$   
 638 x 1000 mm

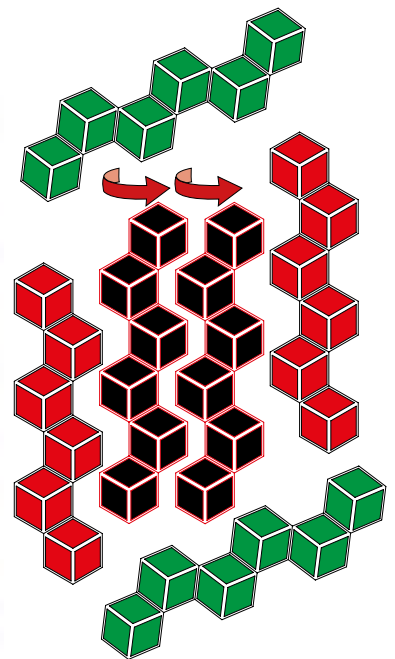

Geometric Style

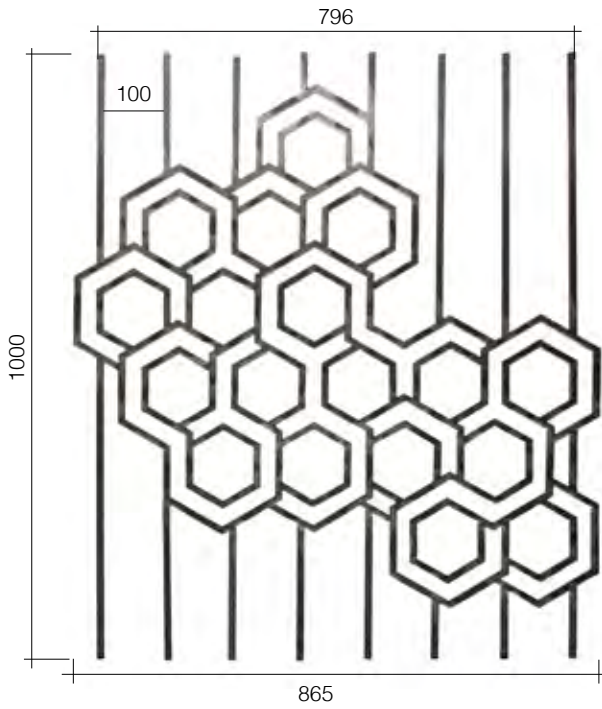

Art. GD301/1  
 Ø 12 x 12 mm  
 865 x 1000 mm

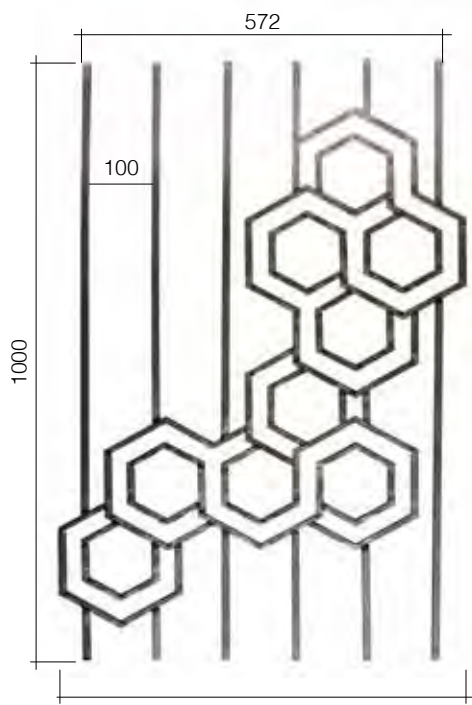
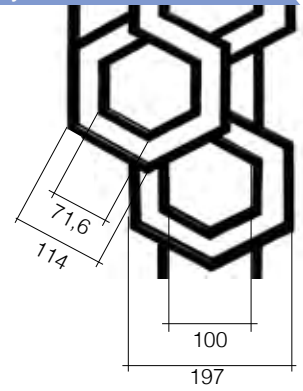

Art. GD301/2  
 Ø 12 x 12 mm  
 642 x 1000 mm

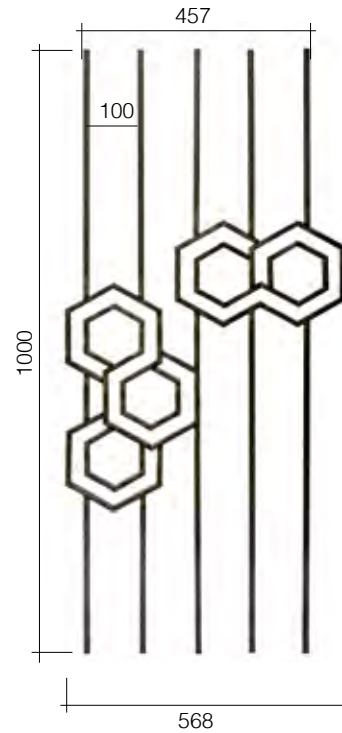

Art. GD301/3  
 Ø 12 x 12 mm  
 568 x 1000 mm

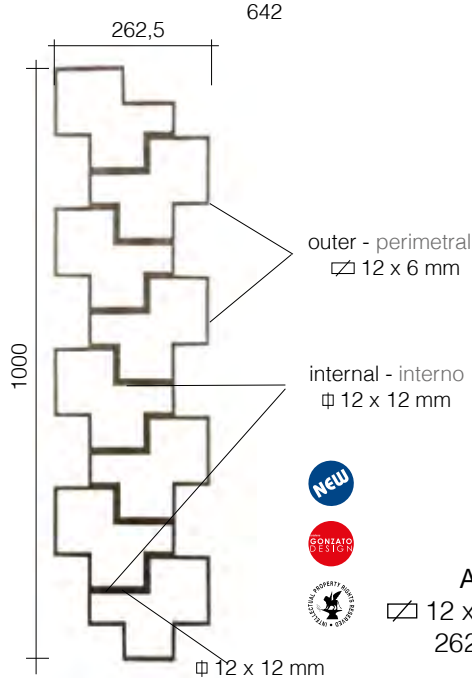

outer - perimetrale  
 12 x 6 mm

internal - interno  
 Ø 12 x 12 mm



Art. GD293/1  
 12 x 6 mm + Ø 12 mm  
 262,5 x 1000 mm



OVERLAPPED PANELS - PANNELLI SOVRAPPOSTI

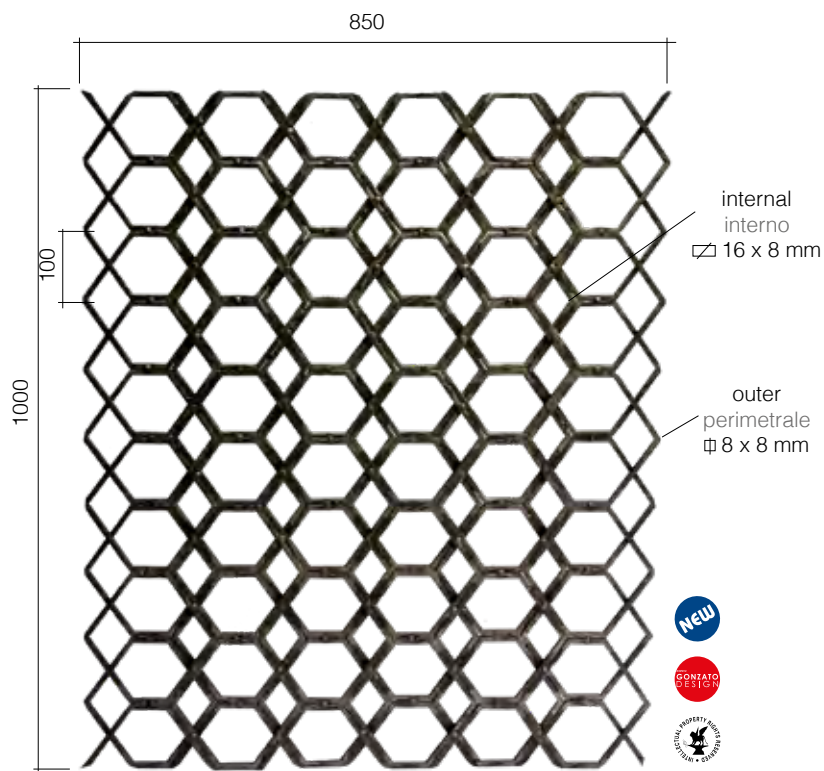

Art. GD299/1  
 $\Phi 8 \times 8 \text{ mm} + \square 16 \times 8 \text{ mm}$   
 850 x 1000 mm

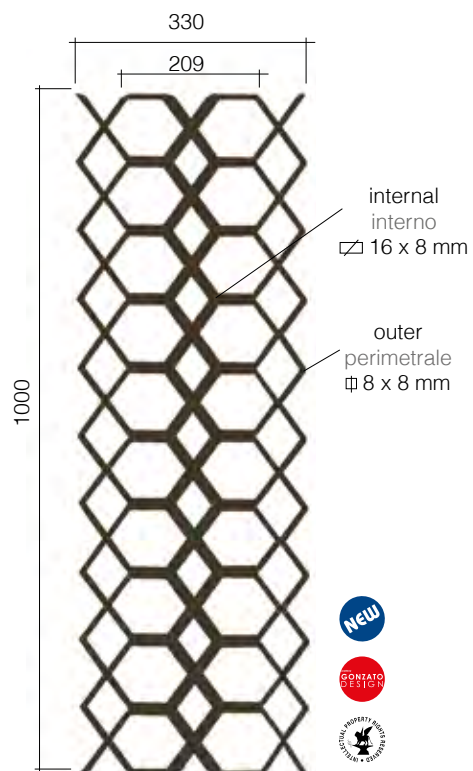

Art. GD299/2  
 $\Phi 8 \times 8 \text{ mm} + \square 16 \times 8 \text{ mm}$   
 330 x 1000 mm

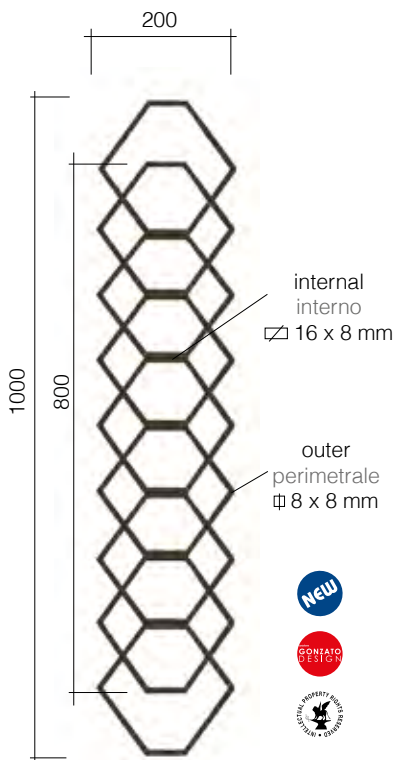

Art. GD299/3  
 $\Phi 8 \times 8 \text{ mm} + \square 16 \times 8 \text{ mm}$   
 200 x 1000 mm

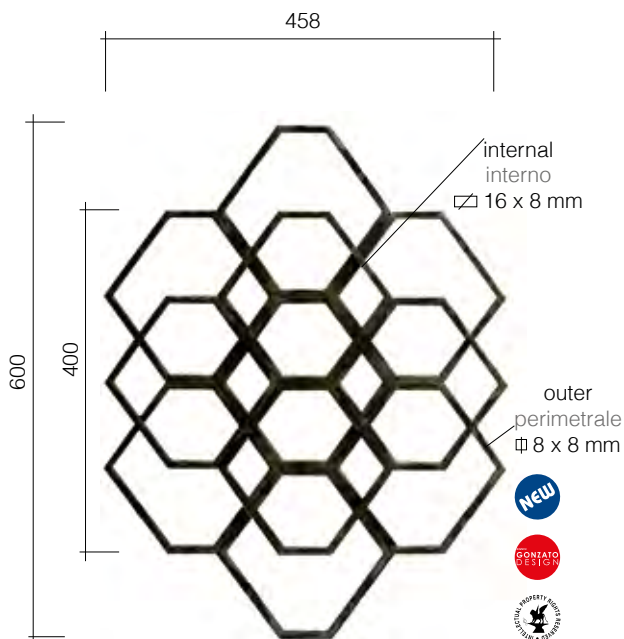

Art. GD299/4  
 $\Phi 8 \times 8 \text{ mm} + \square 16 \times 8 \text{ mm}$   
 458 x 600 mm





OVERLAPPED PANELS  
PANNELLI SOVRAPPOSTI



Panels with sheet metal, 1 mm thick woven between rods, 8 mm diameter

Pannelli con lamiera spessore 1 mm intrecciata tra tondini Ø 8 mm

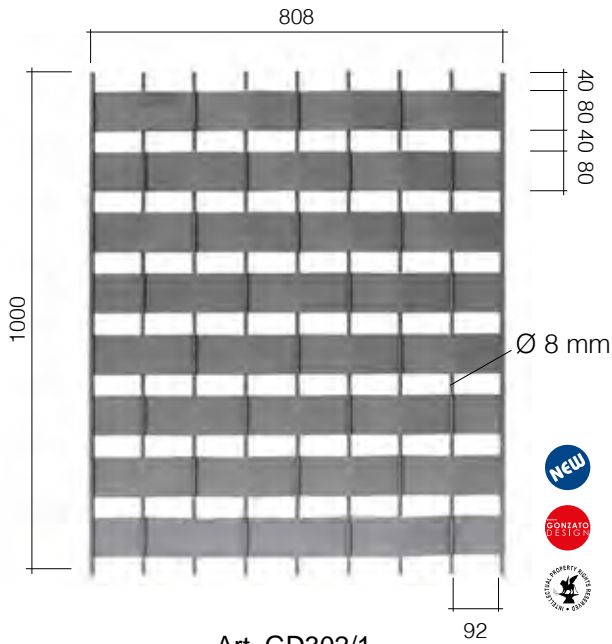

Art. GD302/1  
 □ 16 x 8 mm  
 808 x 1000 mm

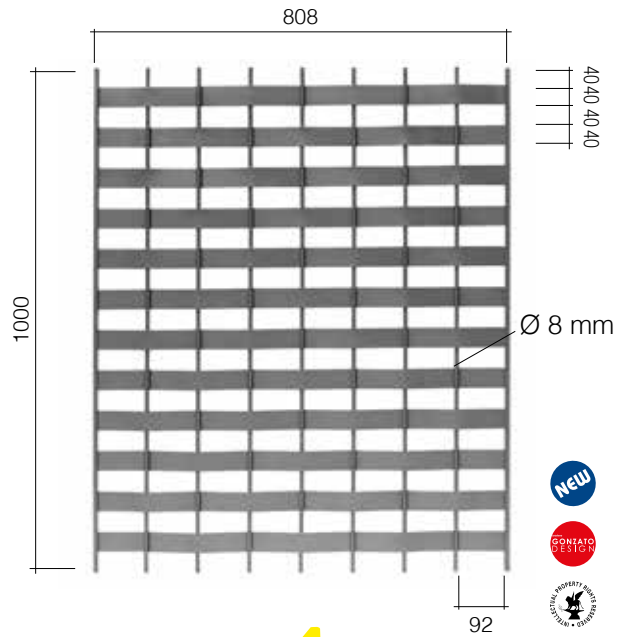

Art. GD302/2  
 □ 16 x 8 mm  
 808 x 1000 mm

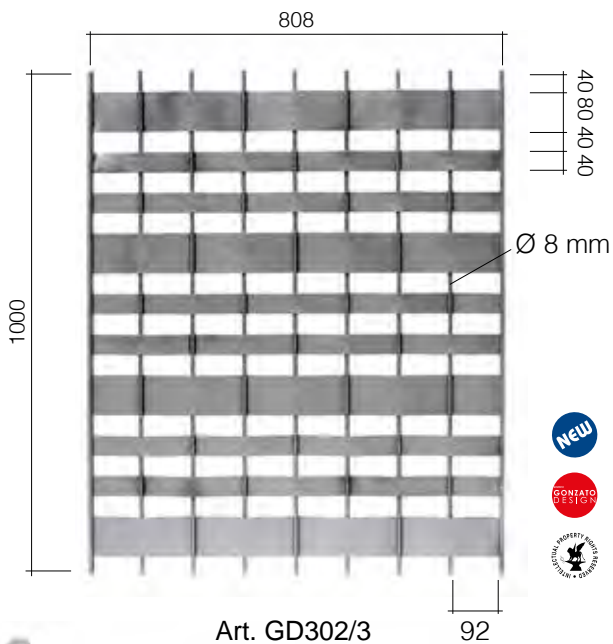

Art. GD302/3  
 □ 16 x 8 mm  
 808 x 1000 mm

**i** **ATTENZIONE:**  
 Viste le peculiarità del prodotto, questo articolo è solo zincabile a freddo. Una zincatura a caldo potrebbe comprometterne l'estetica

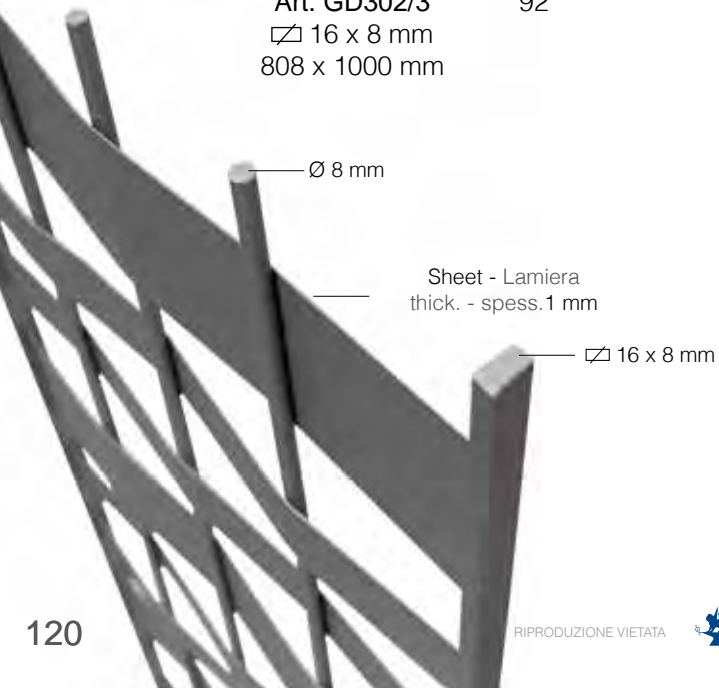

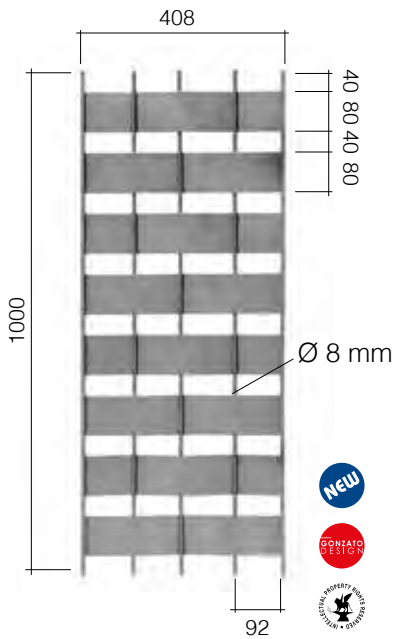

Art. GD303/1  
 ▧ 16 x 8 mm  
 408 x 1000 mm

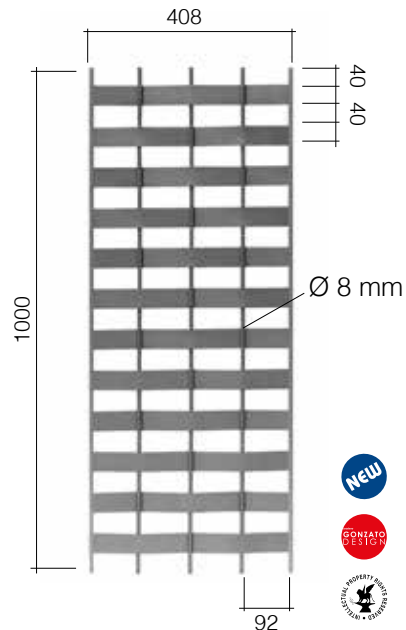

Art. GD303/2  
 ▧ 16 x 8 mm  
 408 x 1000 mm

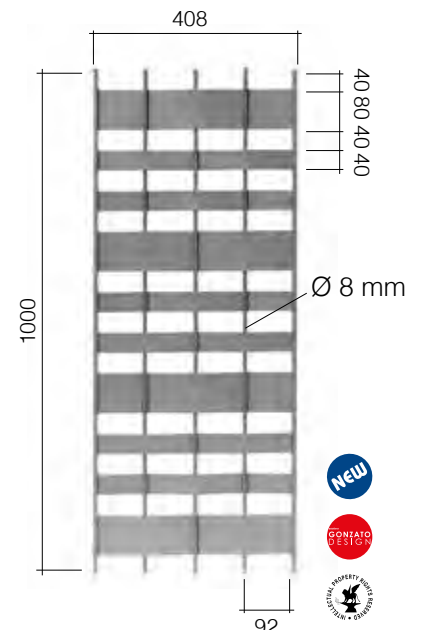

Art. GD303/3  
 ▧ 16 x 8 mm  
 408 x 1000 mm



**i** CAUTION:  
 Considering the peculiarities of this item only **cold galvanizing** is recommended. Hot dip galvanizing would compromise its shape.

Linear Style

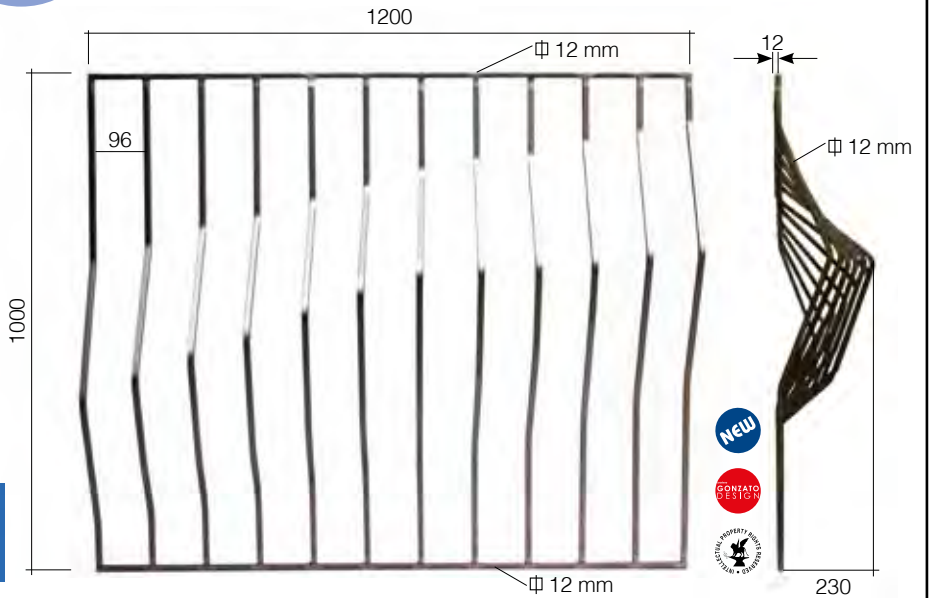

left - sinistro  
**Art. GD289/2**  
 12 x 12 mm  
 1200 x 1000 mm

right - destro  
**Art. GD289/2/S**  
 12 x 12 mm  
 1200 x 1000 mm

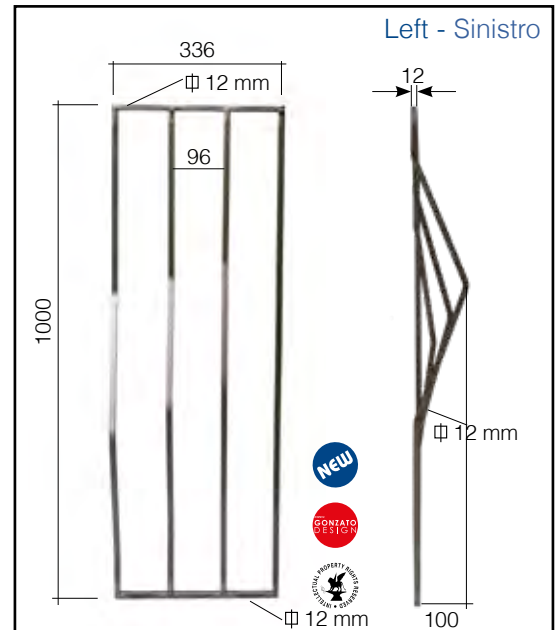

left - sinistro  
**Art. GD293/3**  
 12 x 12 mm  
 336 x 1000 mm

right - destro  
**Art. GD293/3/S**  
 12 x 12 mm  
 336 x 1000 mm

Elements to lead the buffing waves at level zero

Elementi per portare l'onda di tamponatura a livello zero

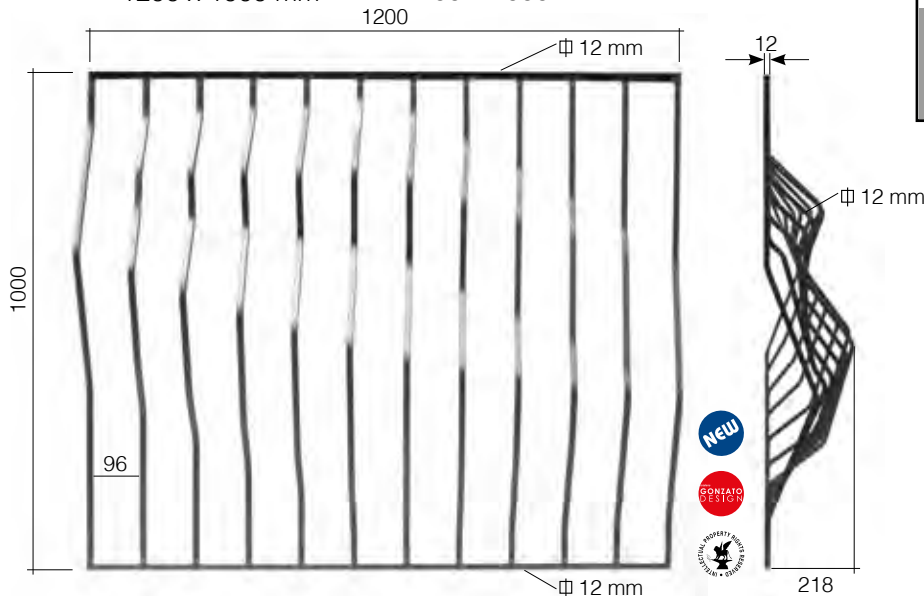

left - sinistro  
**Art. GD289/1**  
 12 x 12 mm  
 1200 x 1000 mm

right - destro  
**Art. GD289/1/S**  
 12 x 12 mm  
 1200 x 1000 mm

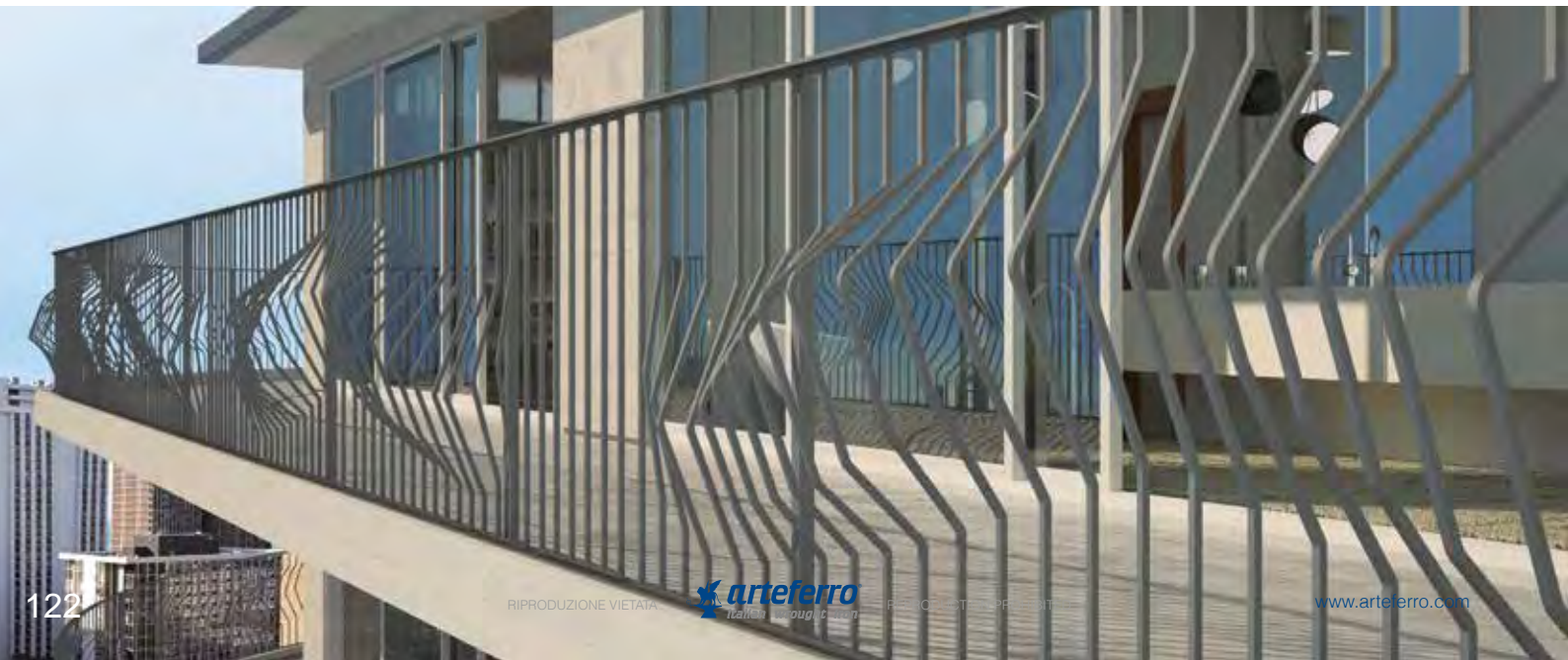

vertical elements Ø 12 mm  
horizontal elements  $\varnothing$  12 mm

elementi verticali Ø 12 mm  
elementi orizzontali  $\varnothing$  12 mm

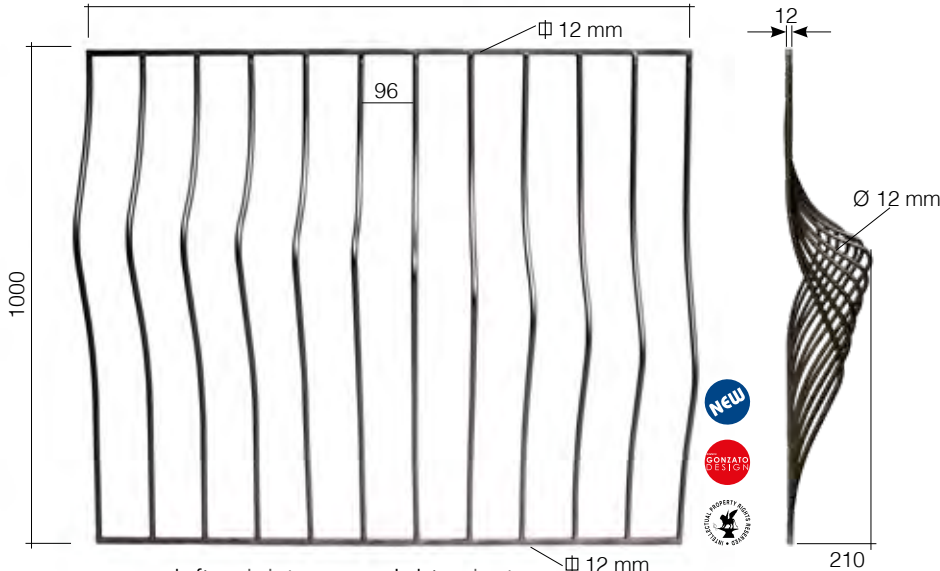

left - sinistro Art. GD294/1  
Ø 12 mm  
1200 x 1000 mm

right - destro Art. GD294/1/S  
Ø 12 mm  
1200 x 1000 mm

Linear Style

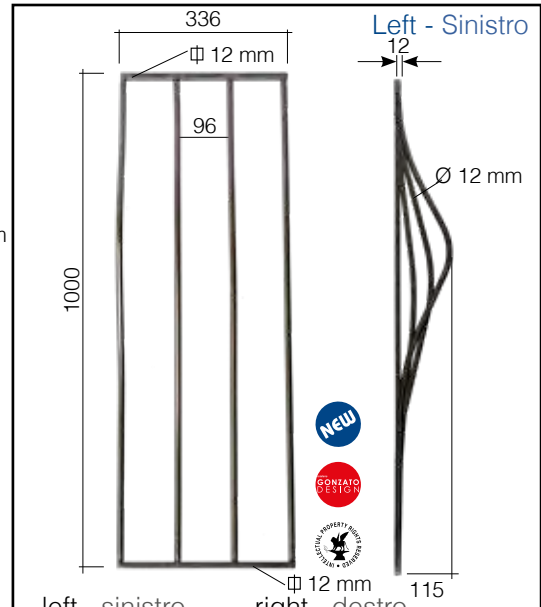

left - sinistro Art. GD294/3  
Ø 12 mm  
336 x 1000 mm

right - destro Art. GD294/3/S  
Ø 12 mm  
336 x 1000 mm

Elements to lead the buffing waves at level zero

Elementi per portare l'onda di tamponatura a livello zero

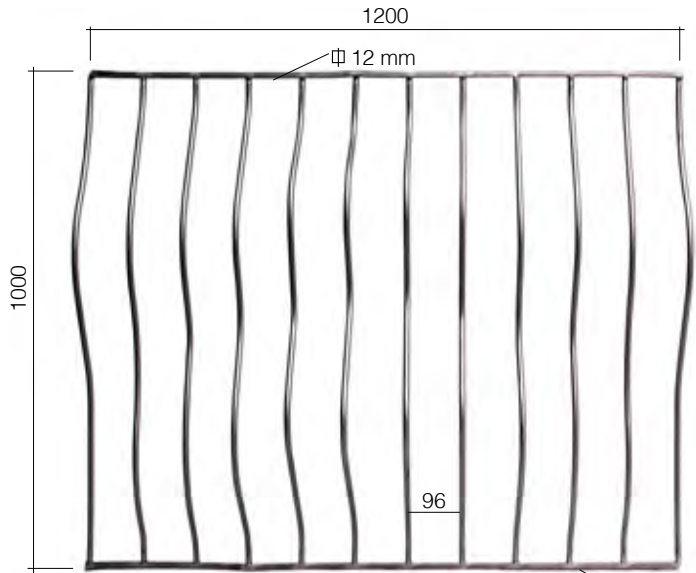

left - sinistro Art. GD294/2  
Ø 12 mm  
1200 x 1000 mm

right - destro Art. GD294/2/S  
Ø 12 mm  
1200 x 1000 mm

vertical elements Ø 12 mm  
horizontal elements  $\varnothing$  12 mm

elementi verticali Ø 12 mm  
elementi orizzontali  $\varnothing$  12 mm

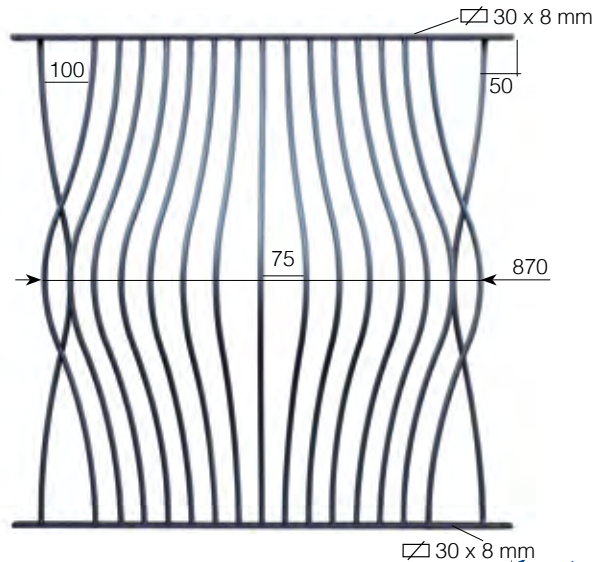

Art. GD288/1  
Ø 12 mm  
1000 x 1000 mm

vertical elements Ø 12 mm  
horizontal elements  $\varnothing$  30 x 8 mm

elementi verticali Ø 12 mm  
elementi orizzontali  $\varnothing$  30 x 8 mm



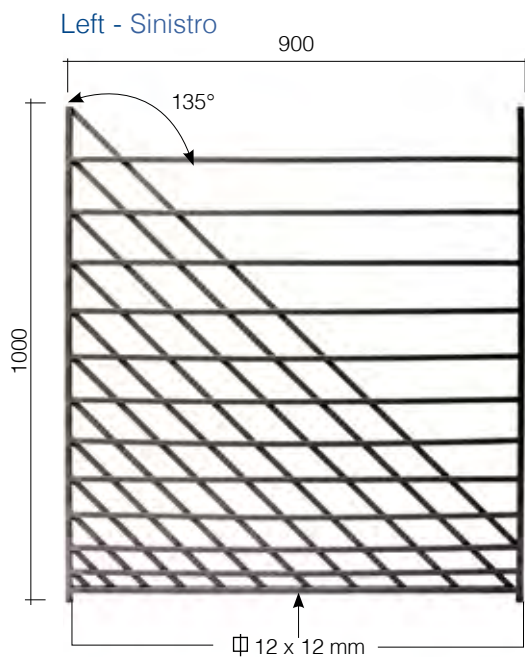

left - sinistro  
**Art. GD297/1**  
 □ 12 x 6 mm + Ø 12 mm  
 L 900 mm  
 H 1000 mm



right - destro  
**Art. GD297/2**  
 □ 12 x 6 mm + Ø 12 mm  
 L 900 mm  
 H 1000 mm

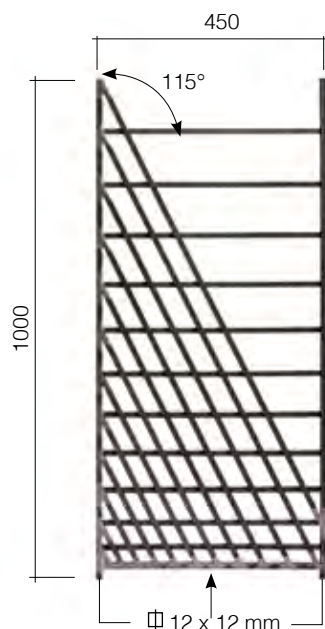

left - sinistro  
**Art. GD298/1**  
 □ 12 x 6 mm + Ø 12 mm  
 L 450 mm  
 H 1000 mm



right - destro  
**Art. GD298/2**  
 □ 12 x 6 mm + Ø 12 mm  
 L 450 mm  
 H 1000 mm



Linear Style

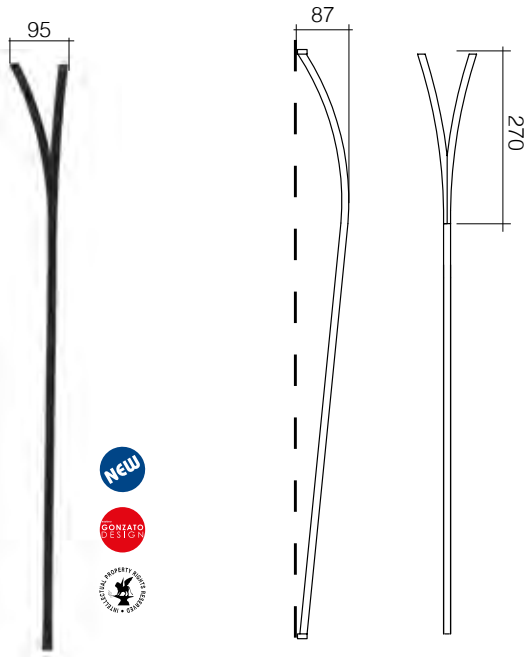

NEW

GONIAIO DESIGN



Art. GD290/2  
 Ø 12 mm  
 H 1000 mm

BEST PRICE

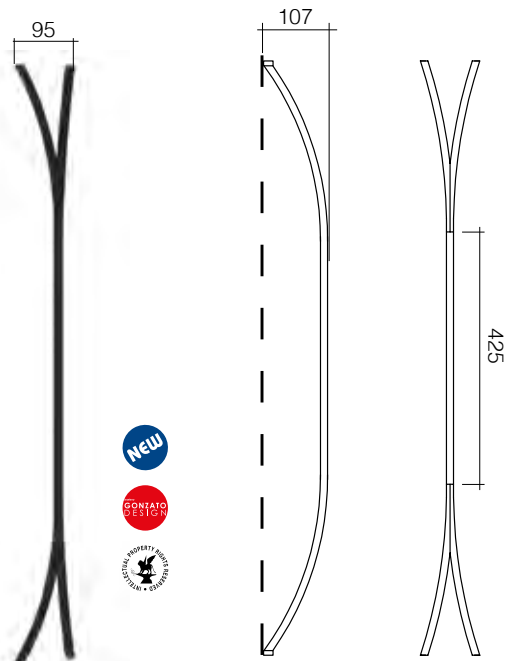

NEW

GONIAIO DESIGN



Art. GD290/1  
 Ø 12 mm  
 H 1000 mm



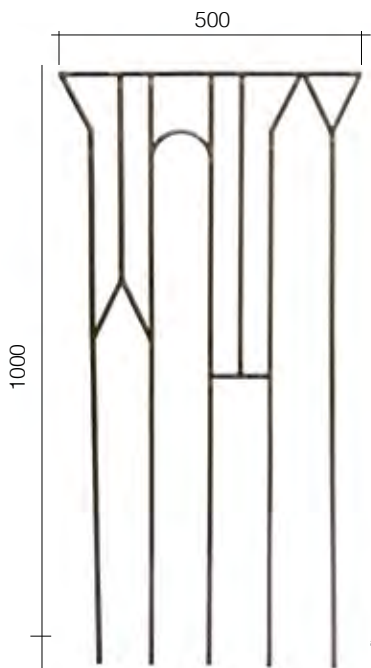

NEW

GIORGIO ARTEFERRO DESIGN



Art. GD295/1  
 □ 14 x 8 mm  
 500 x 1000 mm

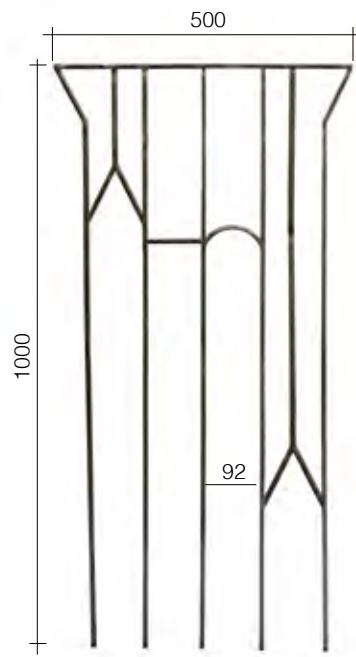

Art. GD295/2  
 □ 14 x 8 mm  
 500 x 1000 mm



Not all of the Arteferro items are available in Arteferro Quick, just a special selection. Find out about the entire range in the catalogue

In Arteferro Quick non sono presenti tutti gli articoli Arteferro, ma solo una speciale selezione. Scopri la gamma completa nel catalogo

*Compendium*





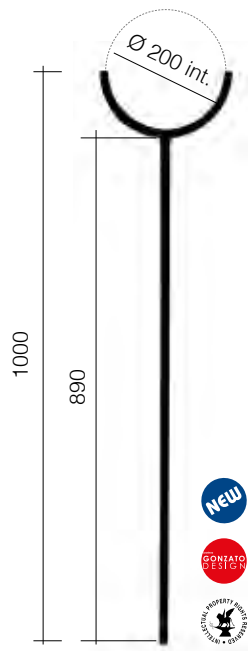

Art. GD296/1  
 Ø 12 x 12 mm  
 Ø 224 x 1000 mm

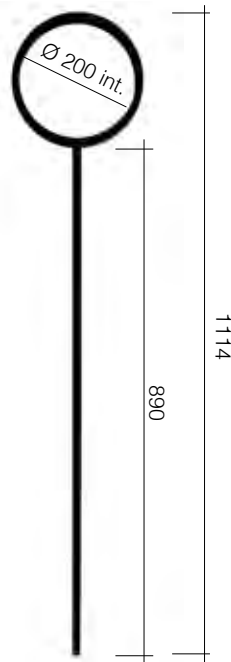

Art. GD296/2  
 Ø 12 x 12 mm  
 Ø 224 x 1114 mm

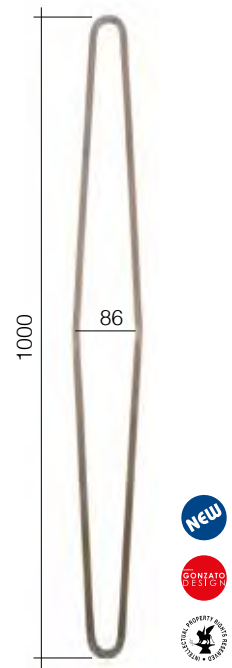

Art. GD293/2  
 Ø 12 x 12 mm  
 110 x 1000 mm





Spheres - Sfere Ø 30 mm

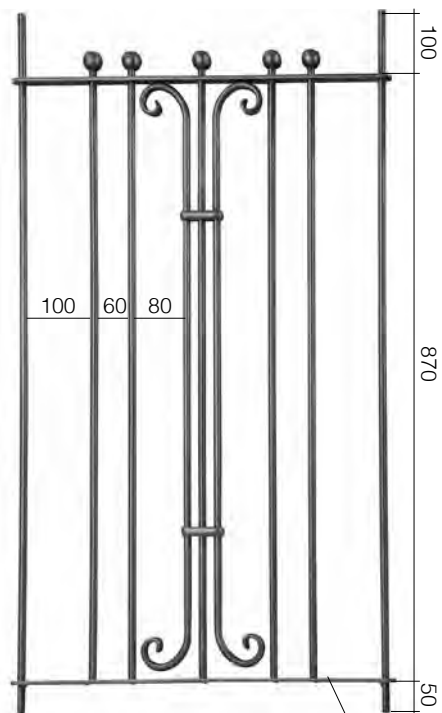

Art. GD45/1  
 Ø 12 mm  
 H 1000 mm  
 L 610 mm



25 x 6 mm

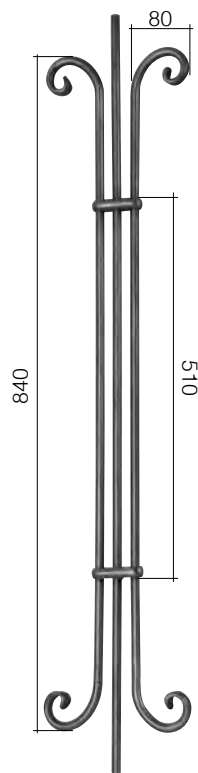

Art. GD45/2  
 Ø 12 mm  
 H 1000 mm  
 L 200 mm

Art. 116/F/3  
 Ø 30 mm



Art. GD43/1  
 Ø 12 mm  
 H 1000 mm

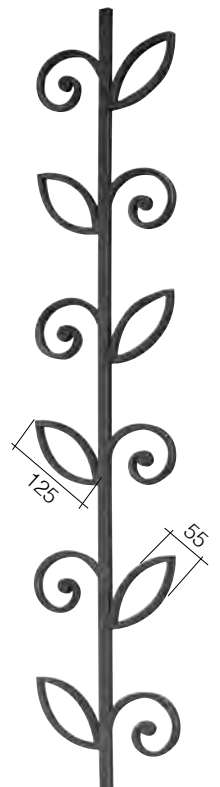
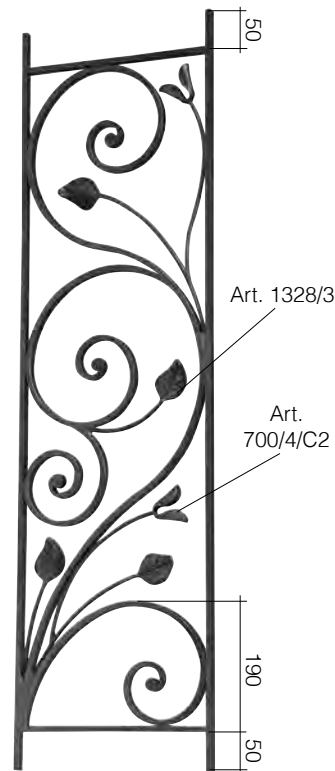

**Art. GD222/1**  
 □ 14 x 8 mm  
 H 1000 mm  
 L 500 mm

**Art. GD222/2**  
 □ 14 x 8 mm  
 H 1000 mm  
 L 500 mm

**Art. GD223/1**  
 □ 14 x 8 mm  
 H 1000 mm  
 L 275 mm

**Art. GD176/3**  
 Φ 14 x 14 mm  
 200 x 1000 mm

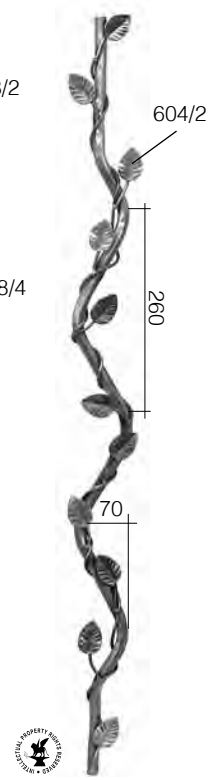

**Art. 1170/1**  
 Ø 12 mm  
 130 x 1000 mm

**Art. 1170/5**  
 Ø 12 mm  
 70 x 1000 mm

**Art. 1170/6**  
 Ø 12 mm  
 70 x 1000 mm

**Art. 1170/2**  
 Ø 12 mm  
 130 x 1000 mm

**Art. 1171/1**  
 Ø 12 mm  
 120 x 1000 mm

**Art. 604/6**  
 Ø 12 mm  
 H 1000 mm

BEST PRICE

spheres - sfere 116/F/4 Ø 40 mm



Art. 1166/1  
Ø 12 mm  
H 900 mm

Art. 1166/2  
Ø 12 mm  
H 900 mm

Art. 1166/3  
Ø 12 mm  
H 900 mm

Art. 1166/4  
Ø 12 mm  
H 900 mm

Art. 1167/3  
Ø 12 mm  
H 1000 mm

Art. 1167/4  
Ø 12 mm  
H 1000 mm

Art. 1167/1  
Ø 12 mm  
H 1000 mm

Art. 1167/2  
Ø 12 mm  
H 1000 mm

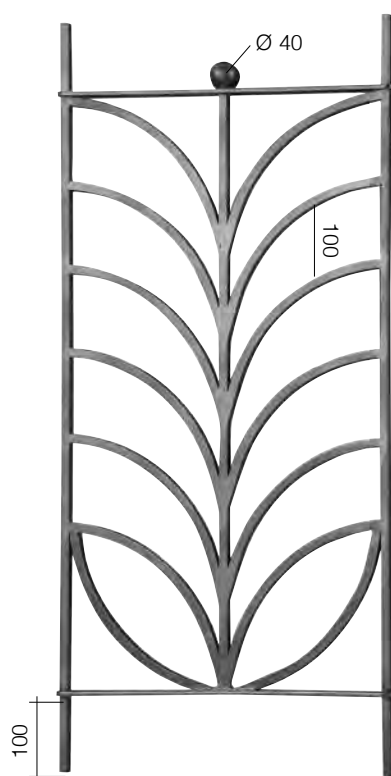

Art. GD73/1  
Ø 12 x 12 mm  
455 x 1000 mm

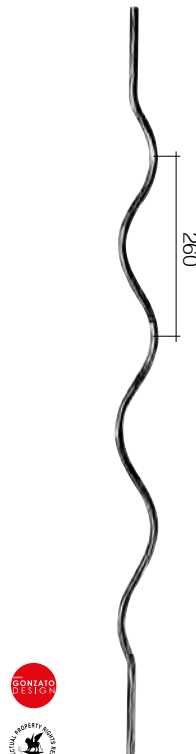

Art. 1171/2  
Ø 12 mm  
60 x 1000 mm



Art. GD92/3  
Ø 12 mm  
100 x 1000 mm



Art. GD92/2  
Ø 12 mm  
130 x 1000 mm

Floreal Style



Art. 715/1  
Ø 12 mm  
580 x H 880 mm  
left - sinistro



left - sinistro

Art. 715/2  
Ø 12 mm  
580 x H 880 mm  
right - destro

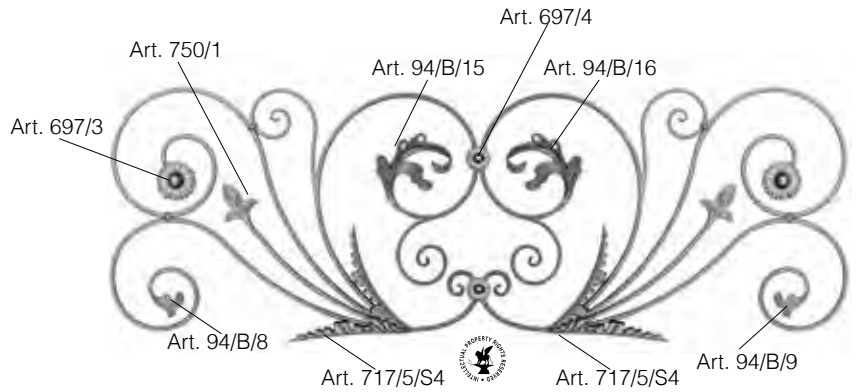

Art. 713/2  
Ø 12 mm  
1780 x H 580 mm



Art. 716/1  
Ø 12 mm  
920 x H 1280 mm  
left - sinistro



left - sinistro

Art. 716/2  
Ø 12 mm  
920 x H 1280 mm  
right - destro

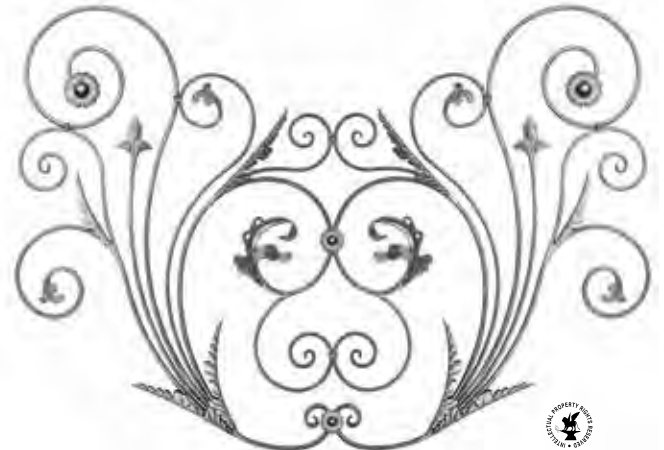

Art. 714/1  
Ø 12 mm  
1600 x H 1150 mm



Art. 716/3  
Ø 12 mm  
760 x H 890 mm  
right - destro



left - sinistro

Art. 716/4  
Ø 12 mm  
760 x H 890 mm  
left - sinistro



Art. 713/1  
Ø 12 mm  
1780 x H 760 mm

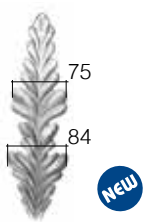

Art. 717/5/S1  
H 285 mm  
Ø 2 mm

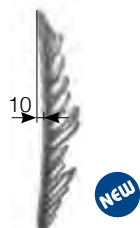

Art. 717/5/S3  
L 25 x H 290 mm  
Ø 2 mm



Art. 717/5/S4  
L 25 x H 285 mm  
Ø 2 mm



Art. 696/3  
H 430 x L 400 mm

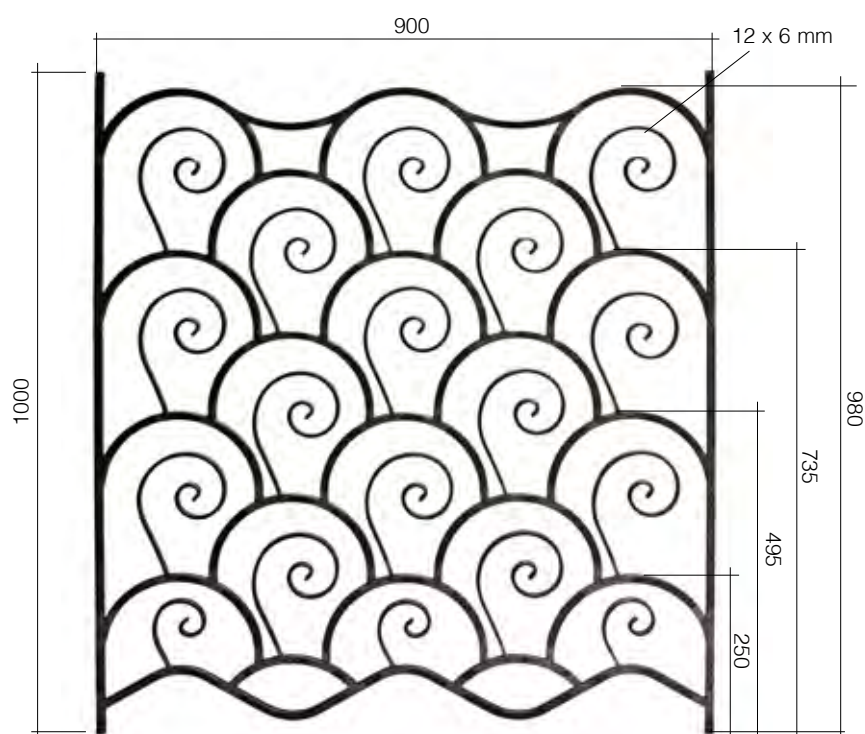

Art. GD291/2  
 ∅ 12 x 12 mm  
 900 x 1000 mm



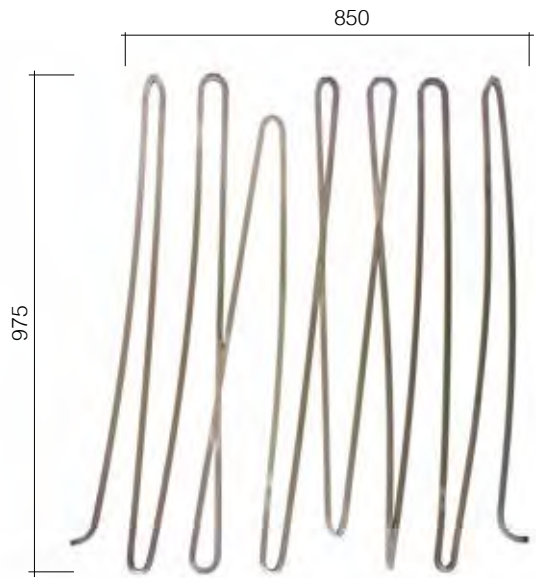

Art. GD300/1  
 ∅ 12 x 12 mm  
 850 x 975 mm

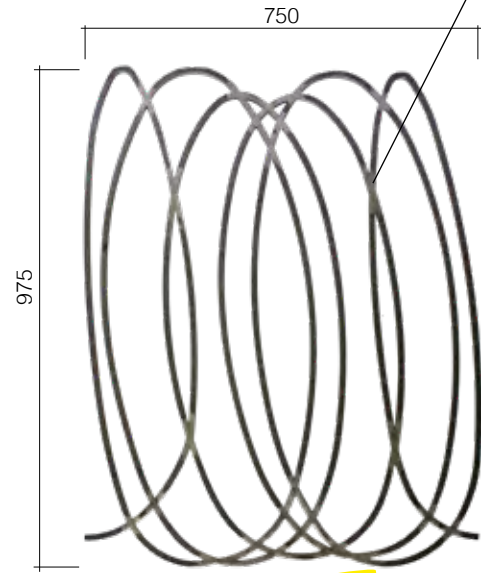

Art. GD300/2  
 ∅ 12 x 12 mm  
 750 x 975 mm

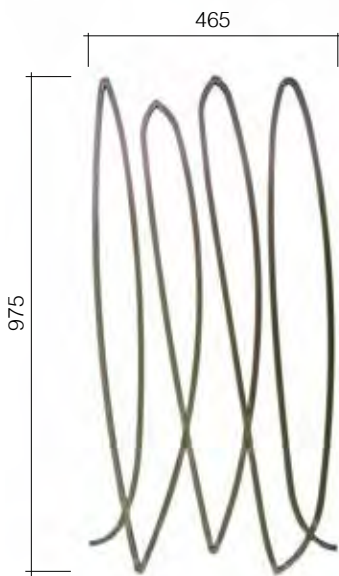

Art. GD300/3  
 ∅ 12 x 12 mm  
 465 x 975 mm



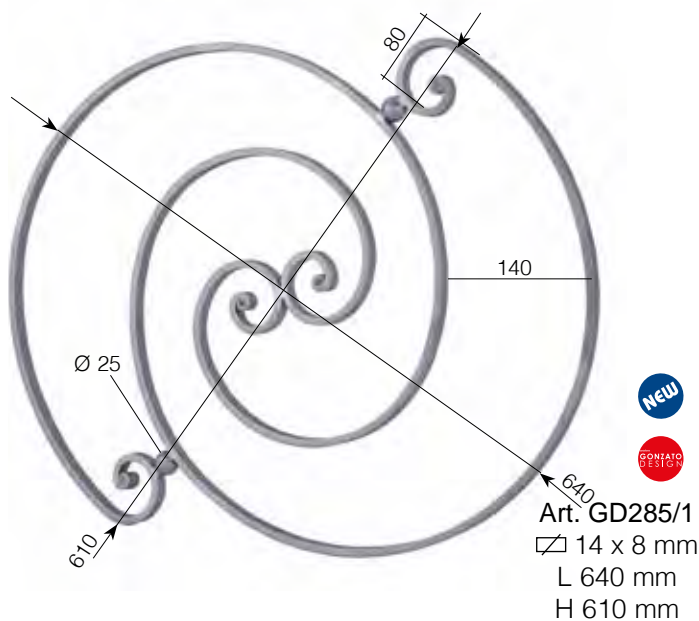

NEW

GONFATO DESIGN

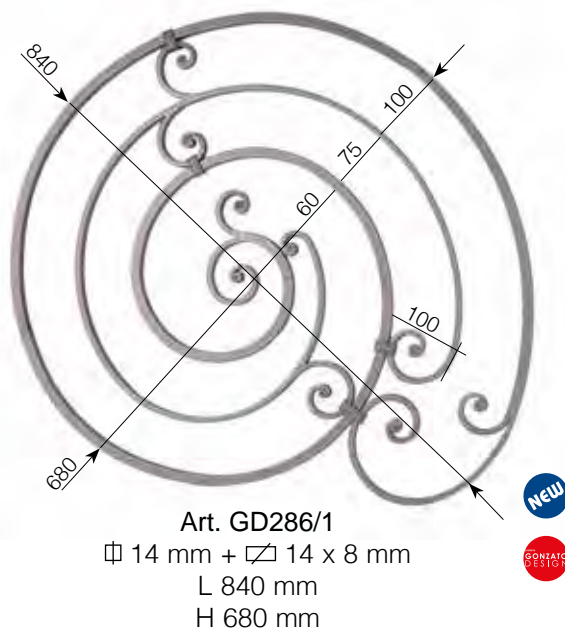

NEW

GONFATO DESIGN

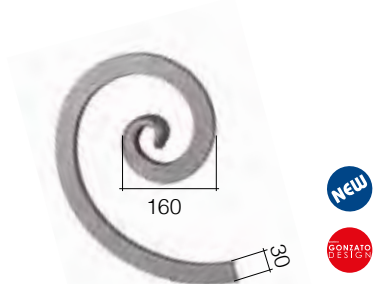

NEW

GONFATO DESIGN

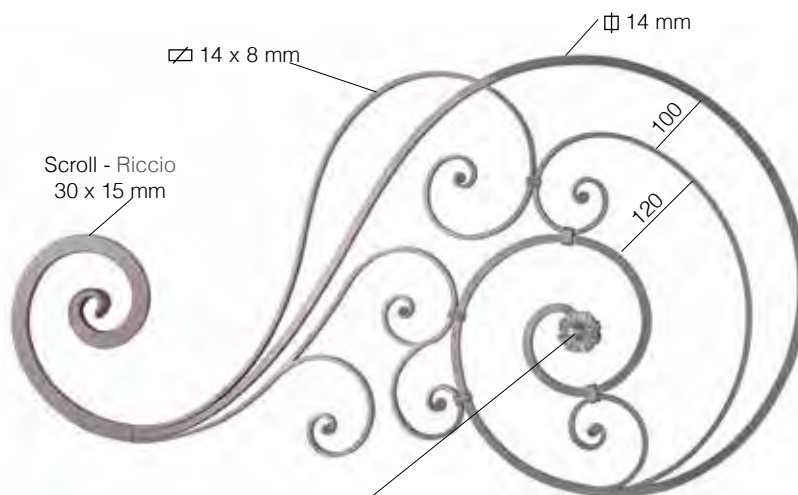
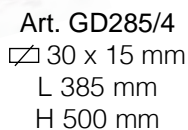

NEW

GONFATO DESIGN

art. 116/A/4  
 on both sides  
 sui due lati

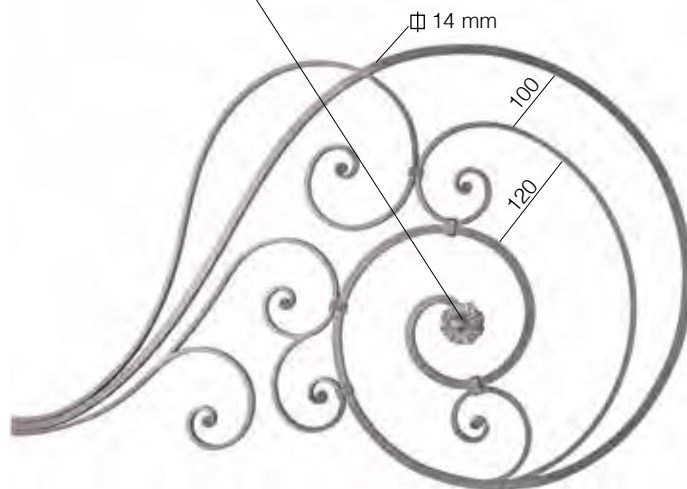

NEW

GONFATO DESIGN





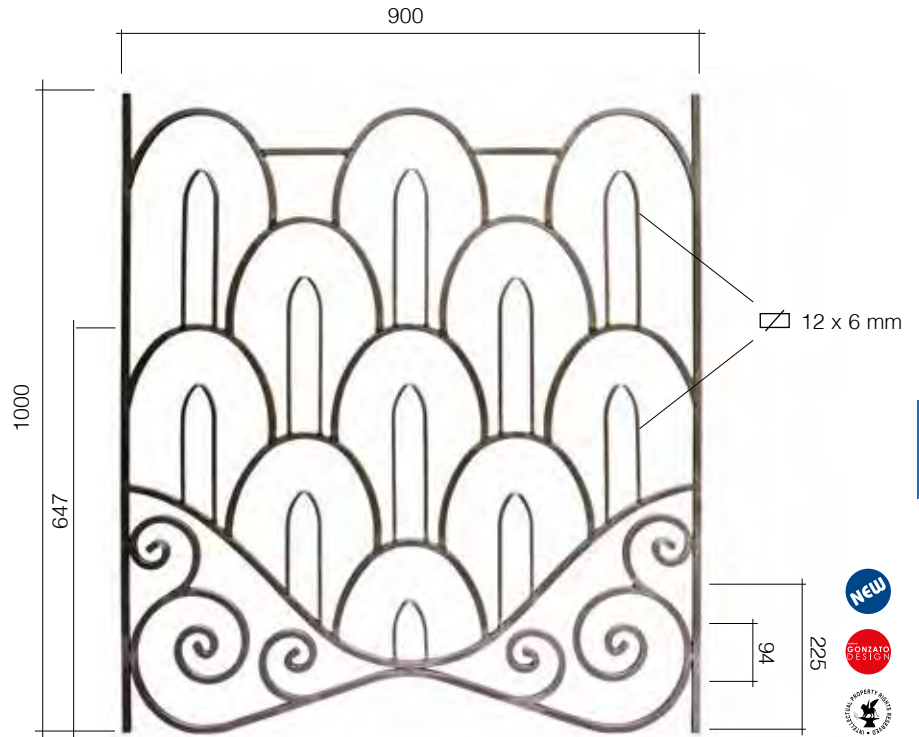

Art. GD291/1  
 $\square$  12 x 12 mm +  $\square$  12 x 6 mm  
 900 x 1000 mm

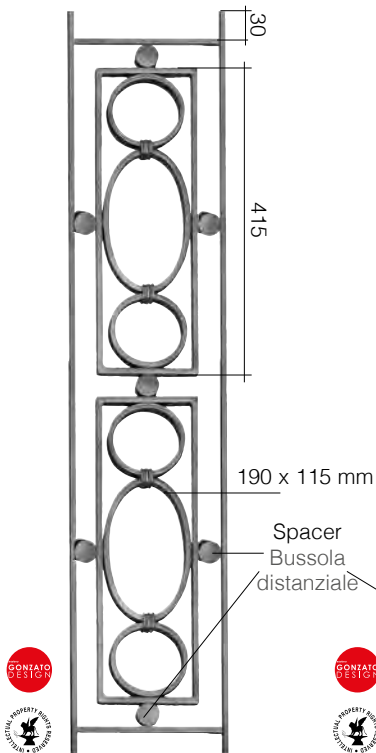

Art. GD205/2  
 $\square$  14 x 8 mm  
 210 x 1000 mm

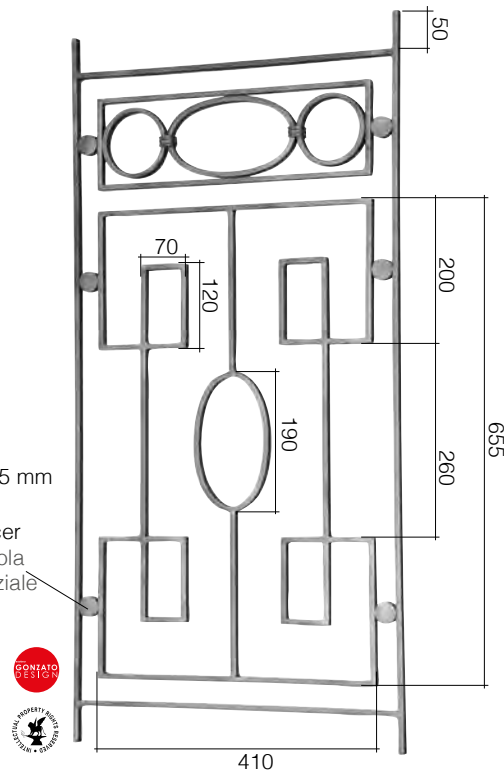

Art. GD205/1  
 $\square$  14 x 8 mm  
 495 x 1000 mm

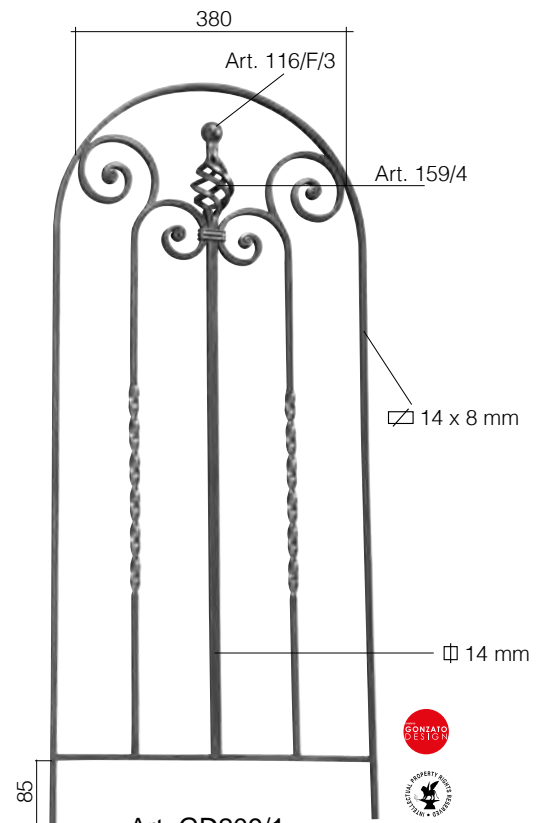

Art. GD209/1  
 $\square$  14 x 8 mm  
 440 x 1000 mm

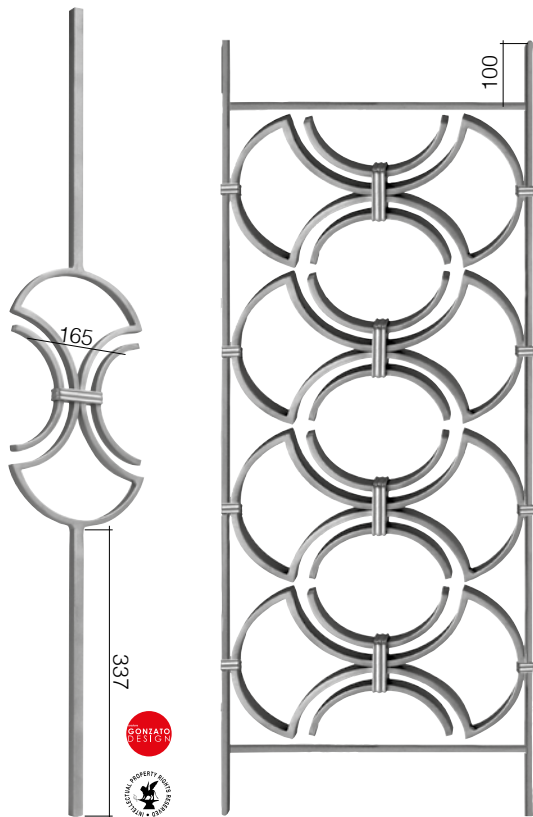

Art. GD187/1  
 Ø 14 mm  
 190 x 1000 mm  
**BEST PRICE**

Art. GD189/2  
 14 x 8 mm  
 340 x 1000 mm

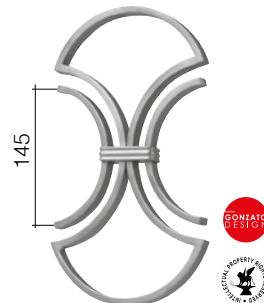

Art. GD187/2  
 14 x 8 mm  
 190 x 325 mm

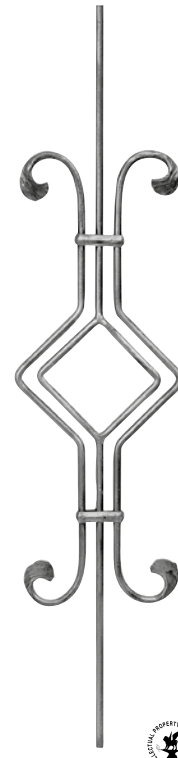

Art. 1074/1  
 Ø 10 mm  
 205 x 1000 mm

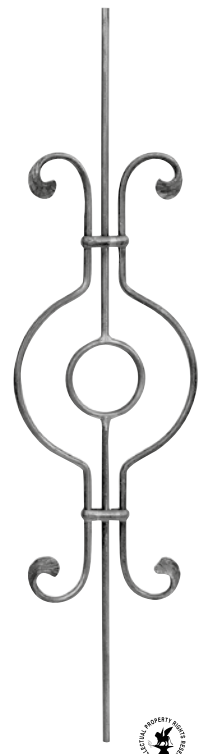

Art. 1074/2  
 Ø 10 mm  
 230 x 1000 mm

Tubular steel frame Ø 25 x 25 mm - Insert iron solid Ø 12 x 12 mm  
 Struttura-telaio tubo Ø 25 x 25 mm - Inserti Ø 12 x 12 mm

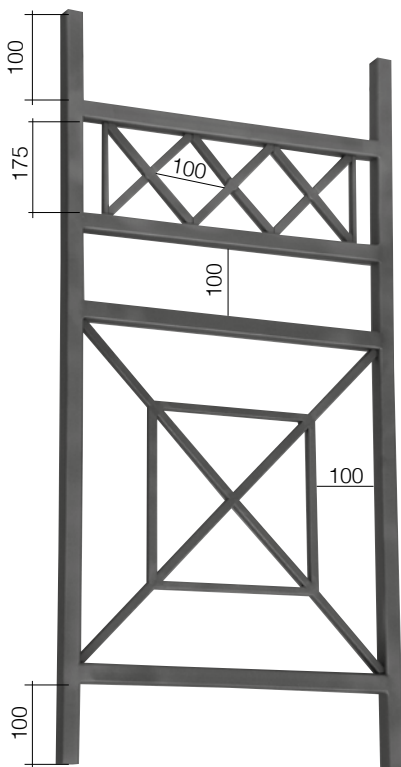

Art. GD76/1  
 H 1000 mm  
 L 500 mm

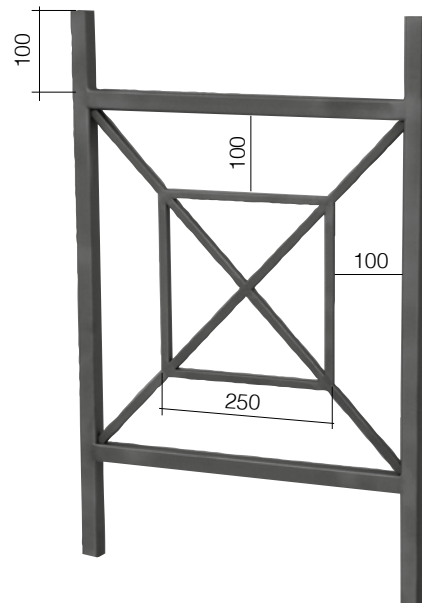

Art. GD76/2  
 H 700 mm  
 L 500 mm

Rosettes 116/A/4 on both sides - Rosette 116/A/4 sui 2 lati

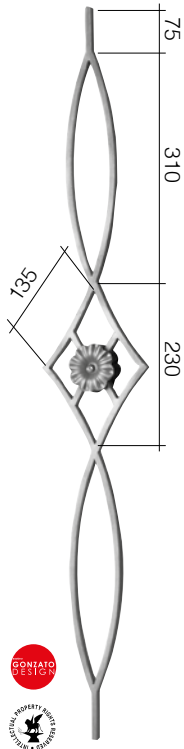

Art. GD16/2  
 □ 14 x 8 mm  
 160 x 1000 mm

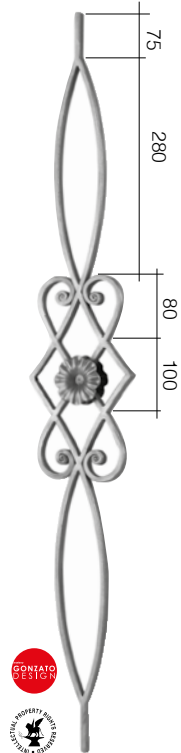

Art. GD16/1  
 □ 14 x 8 mm  
 160 x 1000 mm

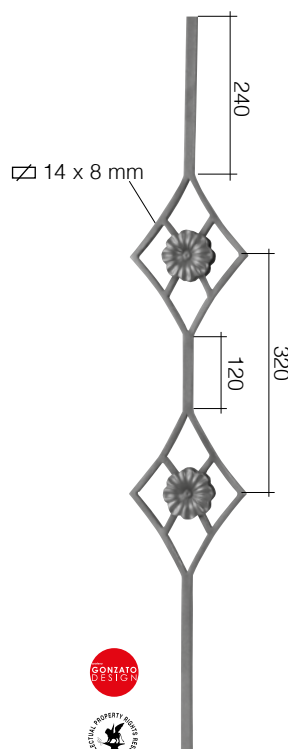

Art. GD18/1  
 □ 14 x 8 mm  
 160 x 1000 mm

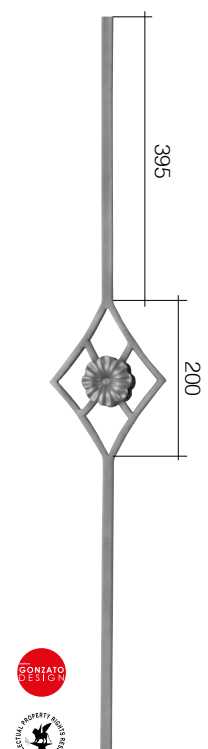

Art. GD18/2  
 □ 14 mm  
 160 x 1000 mm

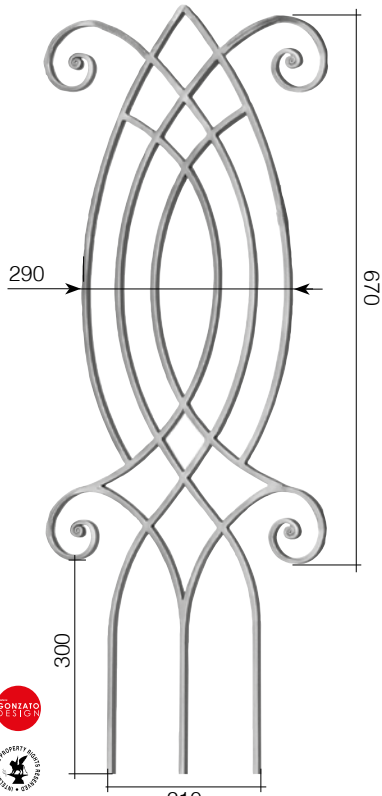

Art. GD234/1  
 □ 14 x 8 mm  
 380 x 1000 mm

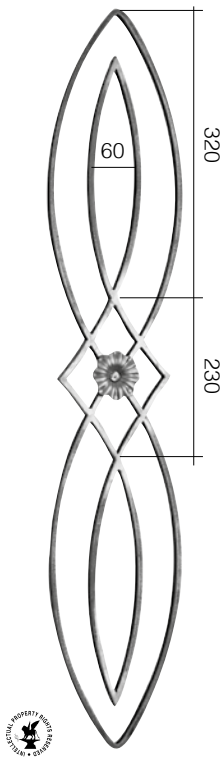

Art. 1680/2  
 □ 14 x 8 mm  
 190 x 1000 mm

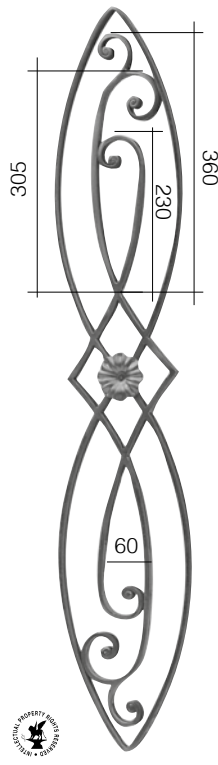

Art. 1681/1  
 □ 14 x 8 mm  
 190 x 1000 mm

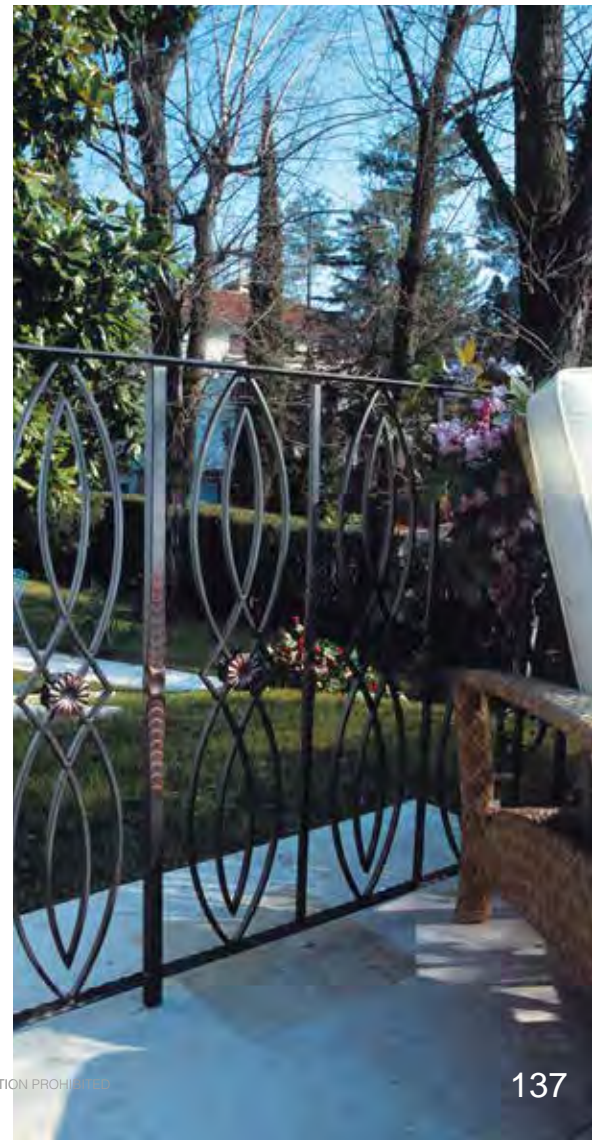

Ornaments - Ornamenti  $\varnothing$  12 x 6 mm

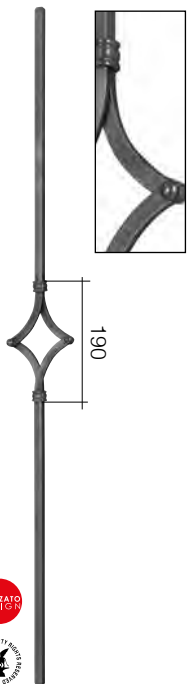

Art. GD20/1 **BEST PRICE**  
 $\varnothing$  12 mm  
 110 x 1000 mm

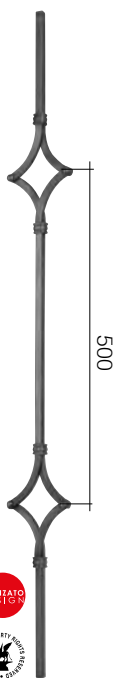

Art. GD20/2  
 $\varnothing$  12 mm  
 110 x 1000 mm

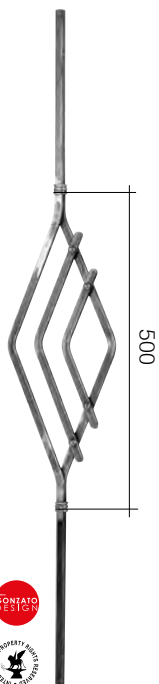

Art. GD20/3  
 $\varnothing$  12 mm  
 180 x 1000 mm



Art. GD20/4  
 $\varnothing$  12 mm  
 200 x 1000 mm

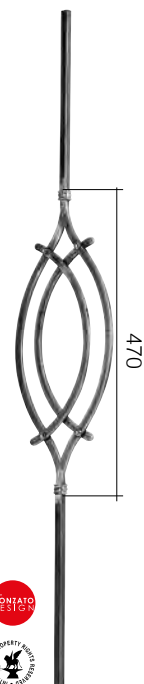

Art. GD20/5  
 $\varnothing$  12 mm  
 180 x 1000 mm

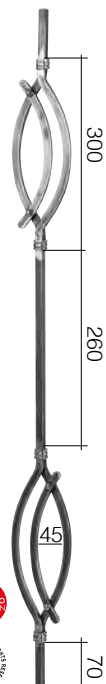

Art. GD20/6  
 $\varnothing$  12 mm  
 100 x 1000 mm

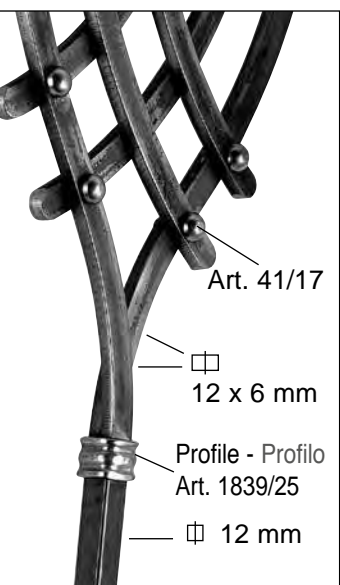

Art. GD20/7  
 $\varnothing$  12 mm  
 100 x 1000 mm

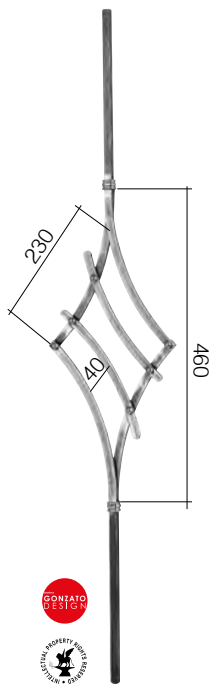

Art. GD20/8  
 $\varnothing$  12 mm  
 200 x 1000 mm



Ornaments - Ornamenti  $\square$  12 x 6 mm

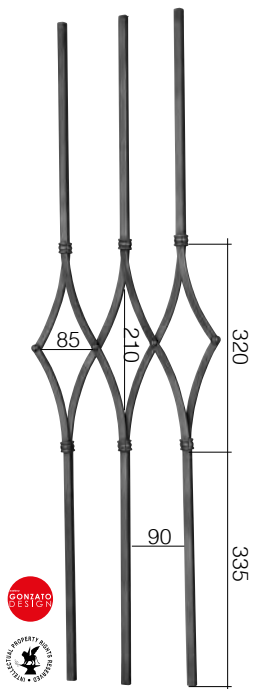

Art. GD21/1  
 $\square$  12 mm  
 315 x 1000 mm

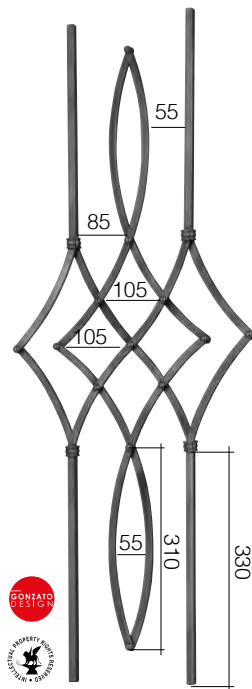

Art. GD21/2  
 $\square$  12 mm  
 415 x 1000 mm

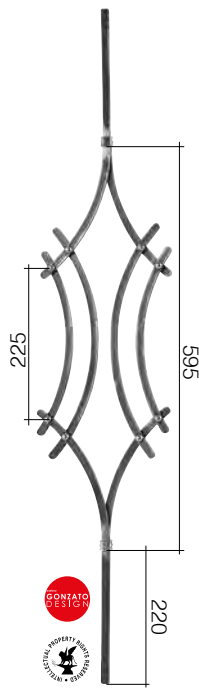

Art. GD21/3  
 $\square$  12 mm  
 200 x 1000 mm

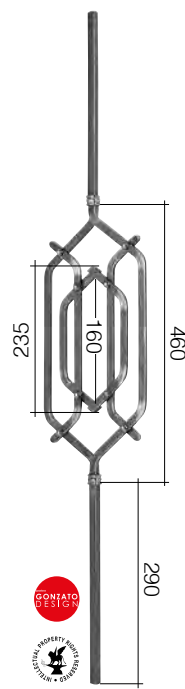

Art. GD21/4  
 $\square$  12 mm  
 180 x 1000 mm

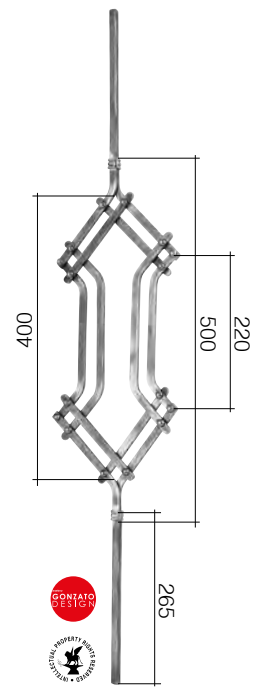

Art. GD21/5  
 $\square$  12 mm  
 200 x 1000 mm

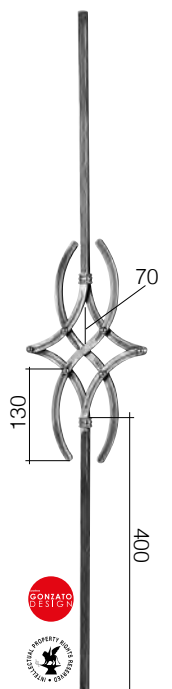

Art. GD21/6  
 $\square$  12 mm  
 200 x 1000 mm



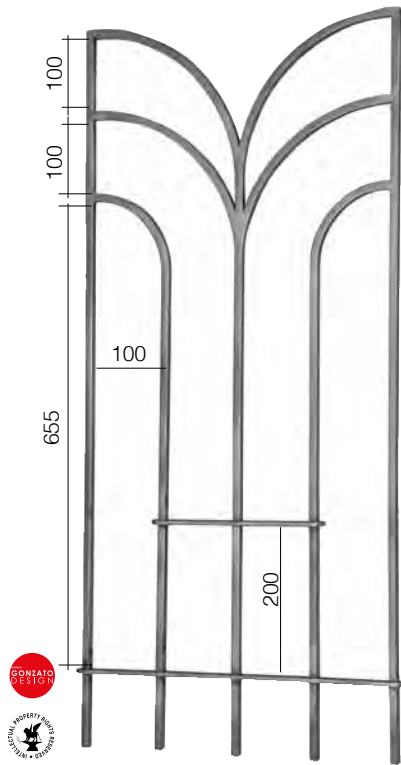

Art. GD68/1  
 □ 12 x 12 mm  
 480 x 1000 mm

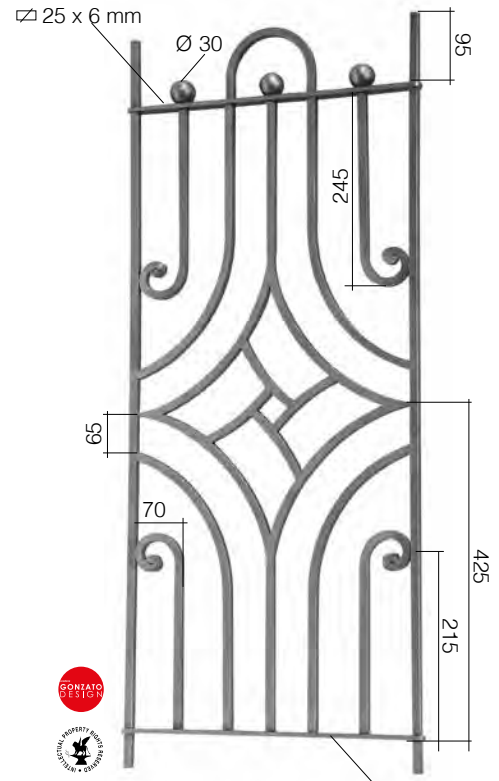

Art. GD212/1 □ 25 x 6 mm  
 □ 12 x 12 mm  
 420 x 1000 mm

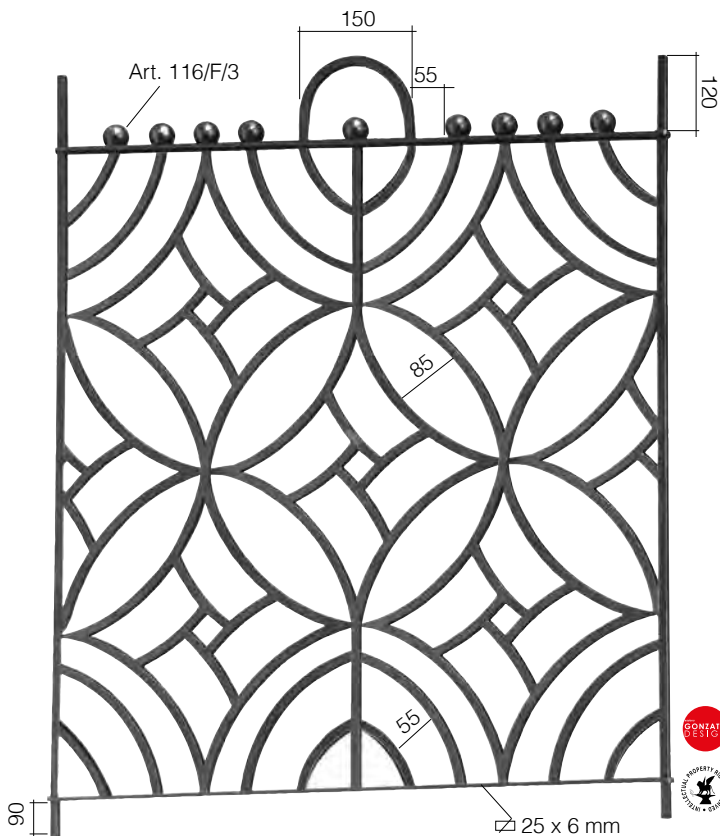

Art. GD211/1  
 □ 12 x 12 mm  
 830 x 1000 mm

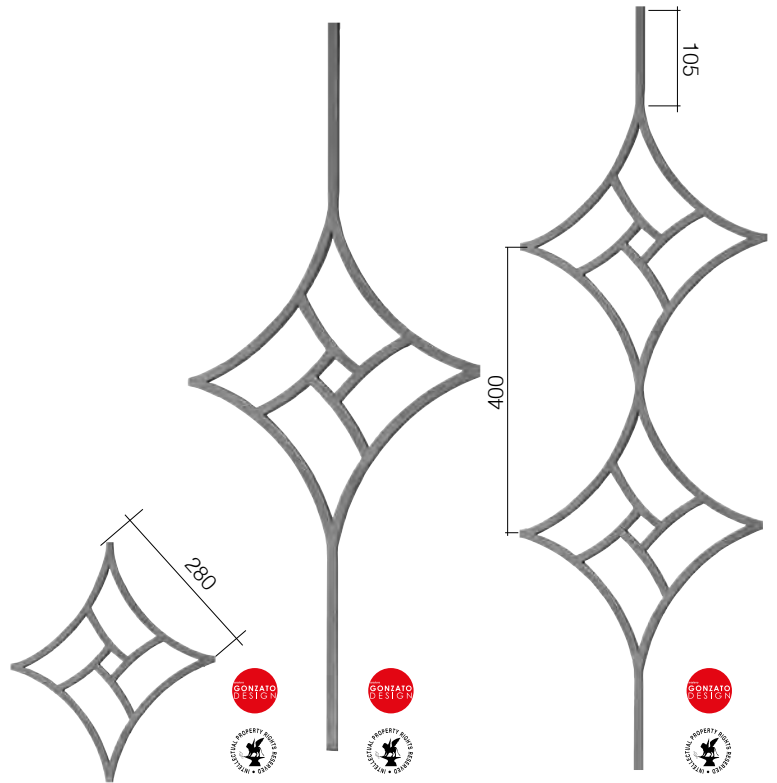

Art. GD211/2  
 □ 12 mm  
 395 x 395 mm



Art. GD211/3  
 □ 12 mm  
 395 x 1000 mm

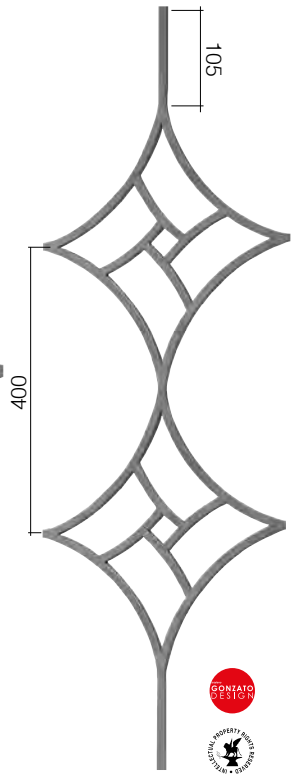

Art. GD211/4  
 □ 12 mm  
 395 x 1000 mm

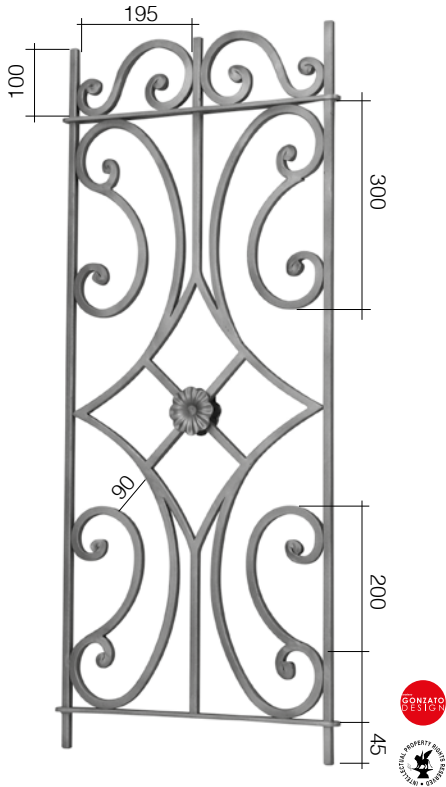

Art. GD61/1  
 Ø 12 x 12 mm  
 430 x 1000 mm

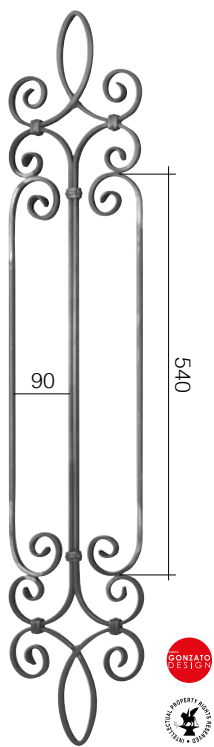

Art. GD35/2  
 Ø 12 x 6 mm  
 200 x 1000 mm

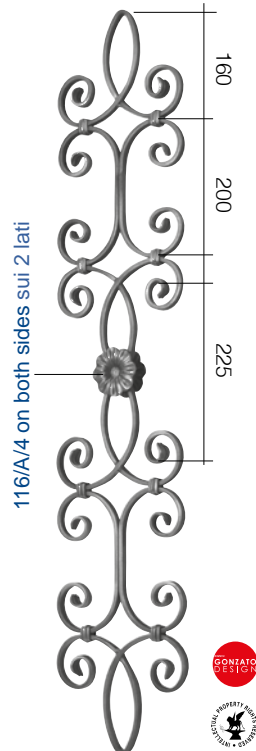

Art. GD35/1  
 Ø 12 x 6 mm  
 200 x 1000 mm

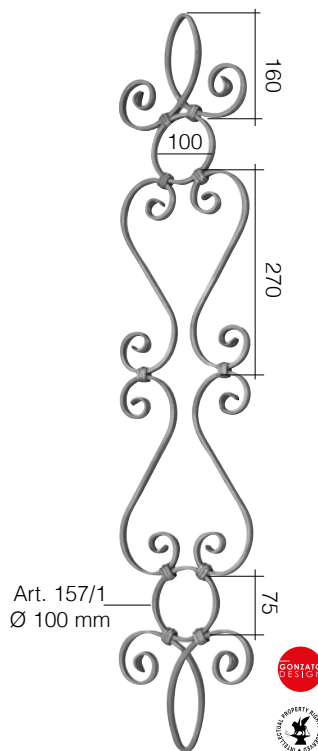

Art. GD35/3  
 Ø 12 x 6 mm  
 200 x 1000 mm

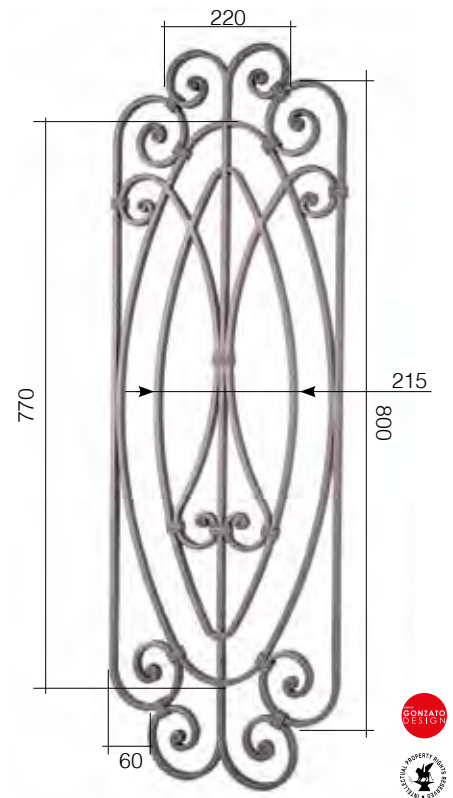

Art. GD284/1  
 Ø 14 x 8 mm  
 350 x 1000 mm

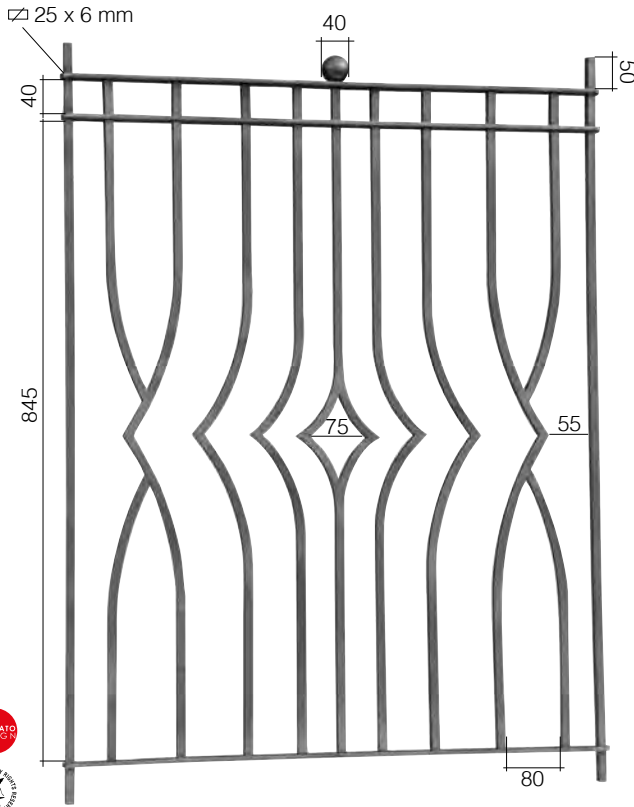

Art. GD232/1  
 ⌀ 12 x 12 mm  
 740 x 1000 mm

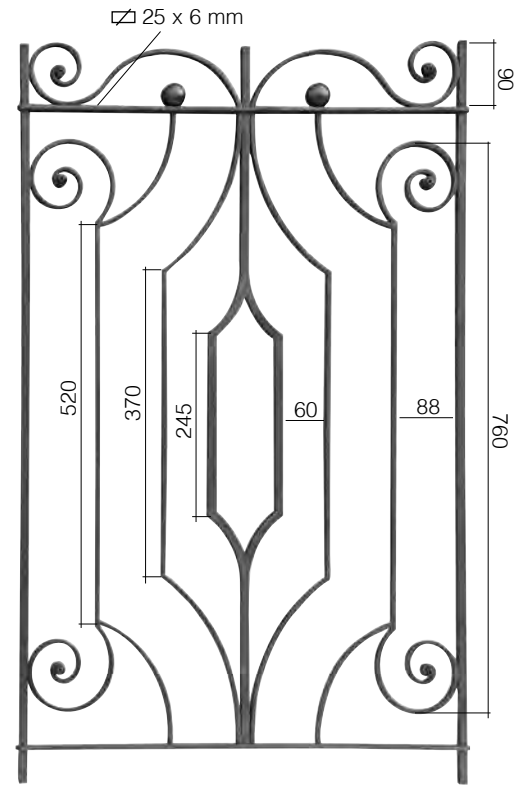

Art. GD242/1  
 ⌀ 12 x 12 mm  
 640 x 1000 mm



116/A/4 on both sides sui 2 lati

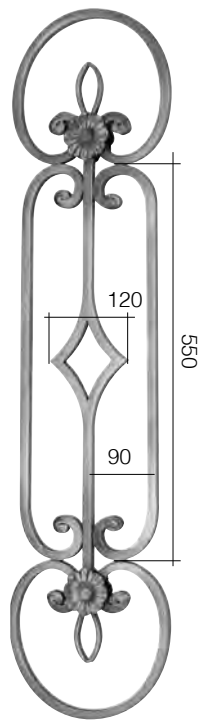

Art. GD31/1  
 ⌀ 14 x 14 mm  
 245 x 1000 mm

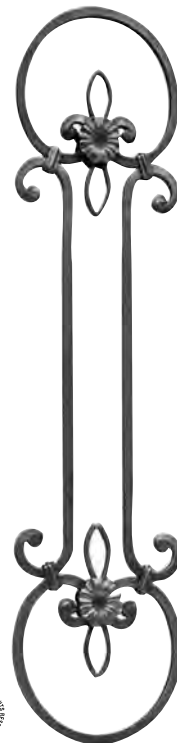

Art. 1682/1  
 ⌀ 14 x 14 mm  
 245 x 1000 mm

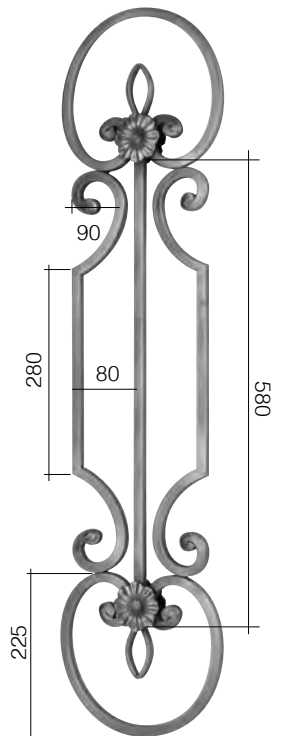

Art. GD31/2  
 ⌀ 14 x 14 mm  
 245 x 1000 mm



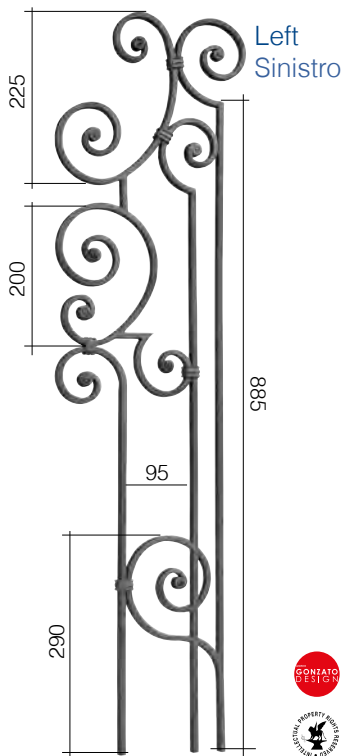

Left  
Sinistro

left - sinistro  
Art. GD163/2  
□ 14 x 8 mm  
L 280 mm  
H 1000 mm

right - destro  
Art. GD163/1  
□ 14 x 8 mm  
L 280 mm  
H 1000 mm

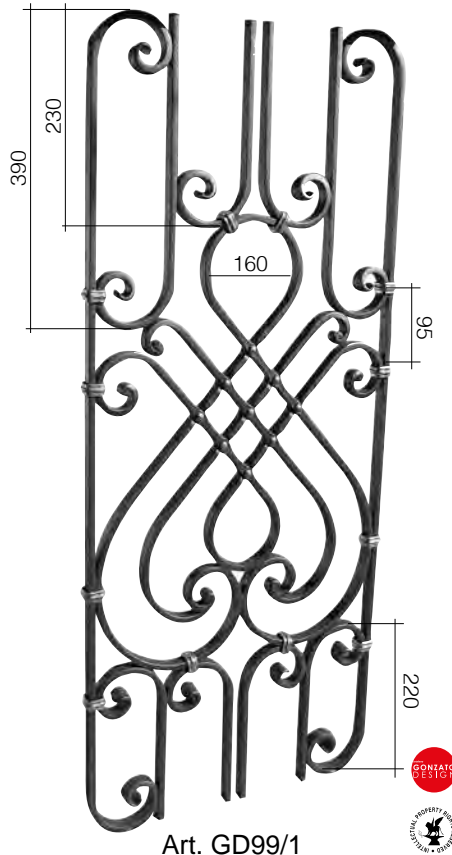

Art. GD99/1  
□ 16 x 8 mm  
420 x 1000 mm

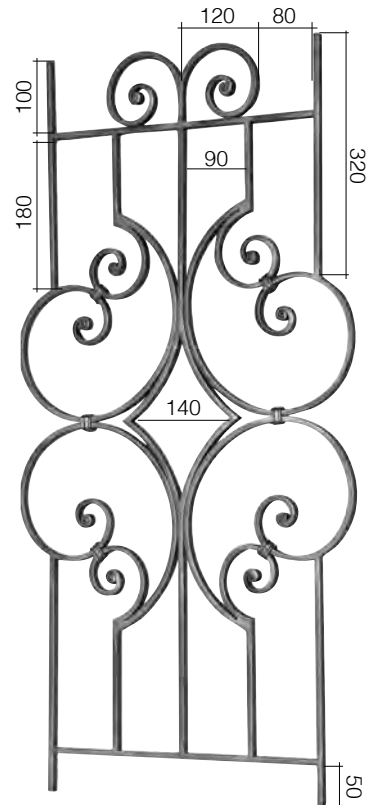

Art. GD219/1  
□ 14 x 8 mm  
500 x 1000 mm



Art. GD236/1  
 □ 14 x 8 mm  
 970 x 1000 mm

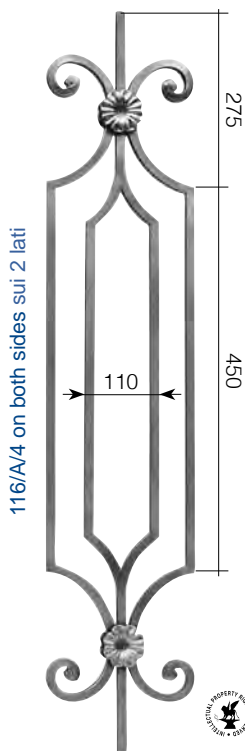

Art. 1685/3  
 □ 14 x 14 mm  
 230 x 1000 mm

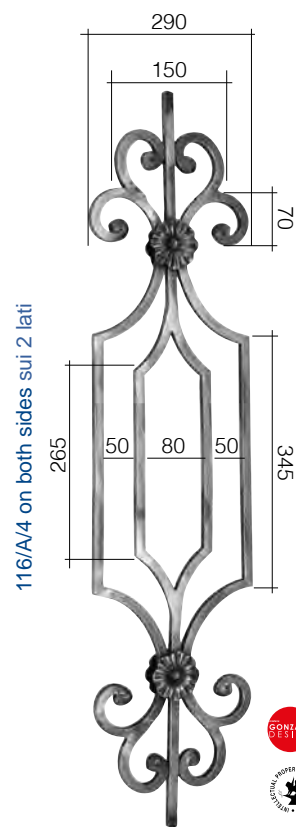

Art. GD22/1  
 □ 14 x 14 mm  
 230 x 1000 mm

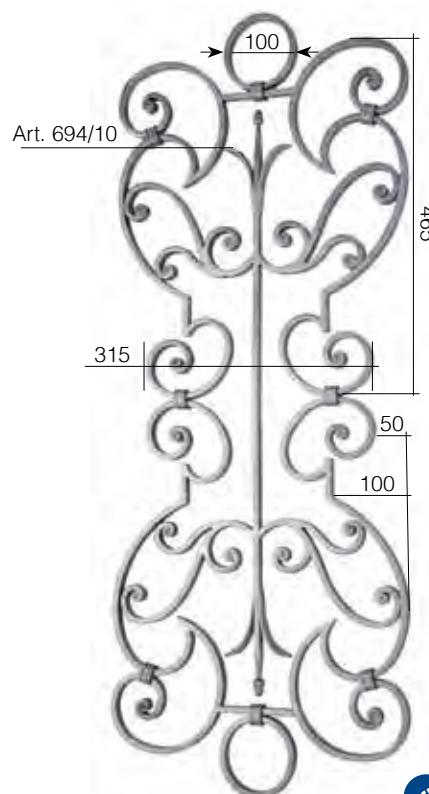

Art. GD282/2  
 □ 14 x 8 mm  
 405 x 1010 mm

NEW



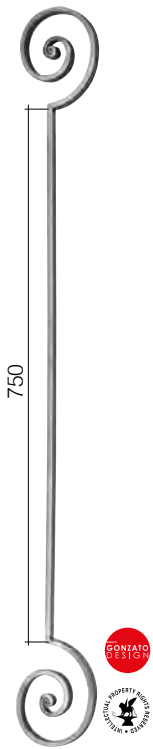

Art. GD175/1  
 □ 14 x 8 mm  
 H 1000 mm  
 L 115 mm

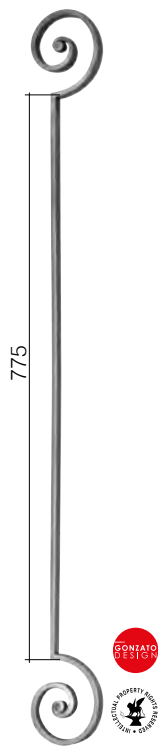

Art. GD175/2  
 □ 14 x 8 mm  
 H 1000 mm  
 L 105 mm

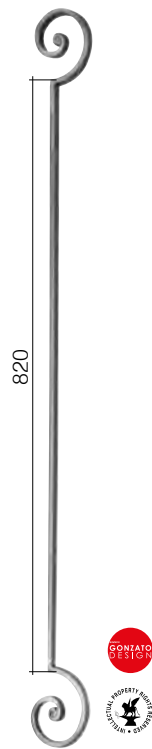

Art. GD175/3  
 □ 14 x 8 mm  
 H 1000 mm  
 L 80 mm

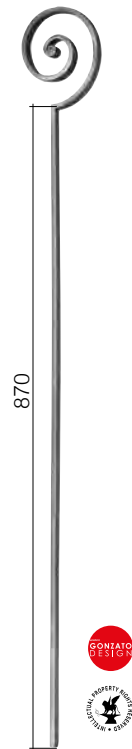

Art. GD175/4  
 □ 14 x 8 mm  
 H 1000 mm  
 L 115 mm

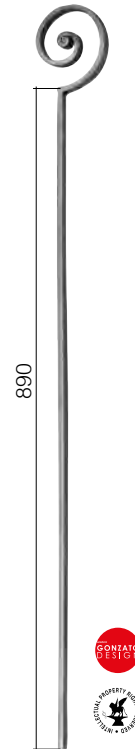

Art. GD175/5  
 □ 14 x 8 mm  
 H 1000 mm  
 L 105 mm

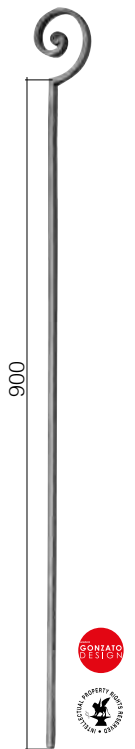

Art. GD175/6  
 □ 14 x 8 mm  
 H 1000 mm  
 L 85 mm

BEST PRICE

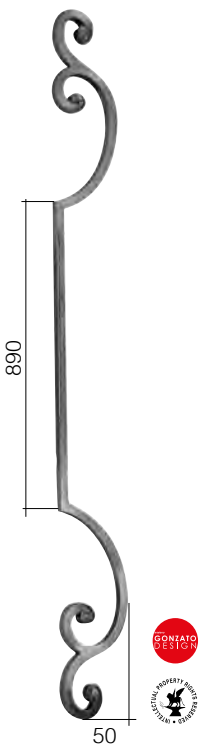

Art. GD22/3  
 Φ 14 x 14 mm  
 110 x 1000 mm



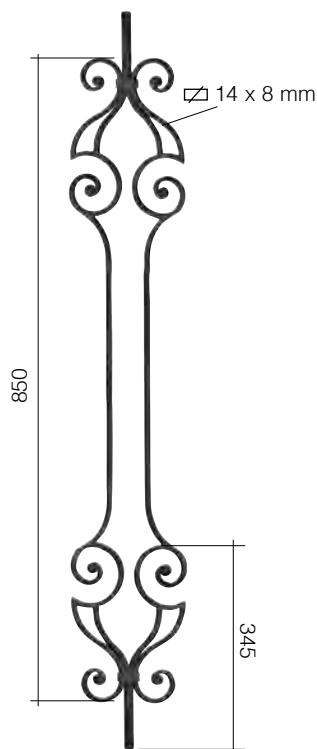

Art. GD150/2  
 Ø 14 x 14 mm  
 205 x 1000 mm

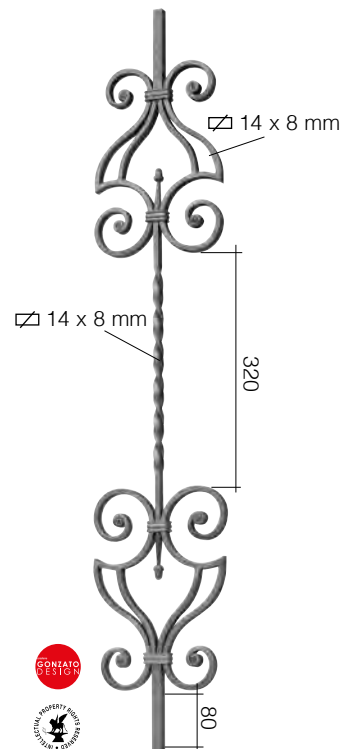

Art. GD150/3  
 Ø 14 x 14 mm  
 205 x 1000 mm

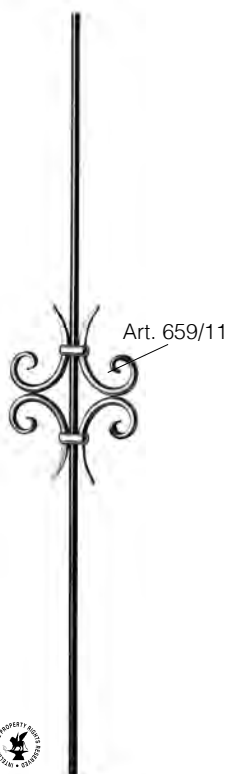

Art. 1066/5  
 Ø 12 mm  
 180 x 1000 mm



Art. 1066/4  
 Ø 12 mm  
 180 x 1000 mm



Art. GD151/1  
 Ø 14 x 14 mm  
 205 x 1000 mm

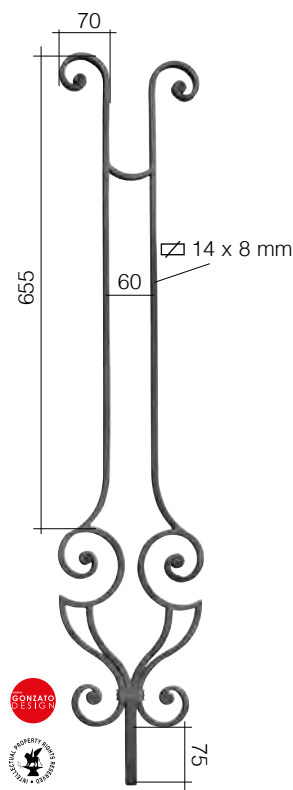

Art. GD148/1  
 Ø 14 x 14 mm  
 205 x 1000 mm

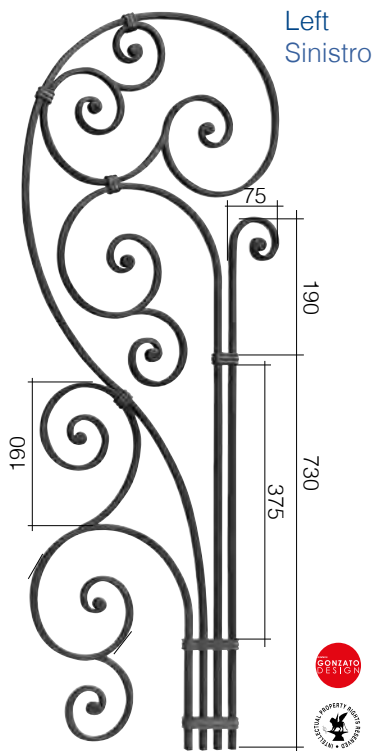

left - sinistro  
Art. GD164/1  
Ø 14 x 8 mm  
L 380 mm  
H 1000 mm

right - destro  
Art. GD164/2  
Ø 14 x 8 mm  
L 380 mm  
H 1000 mm

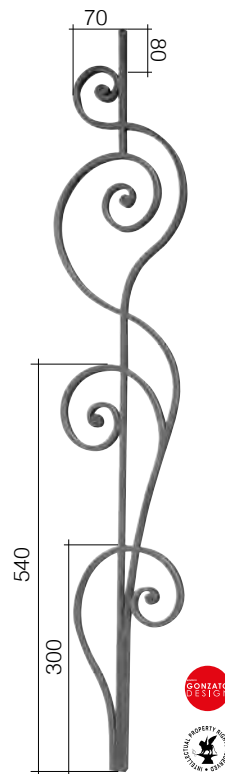

Art. GD228/2  
Ø 14 x 8 mm  
190 x 1000 mm

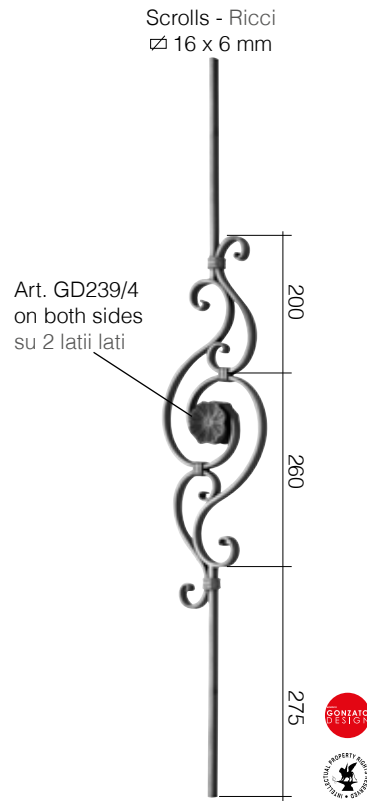

Art. GD271/5  
Ø 16 x 8 mm  
175 x 1000 mm

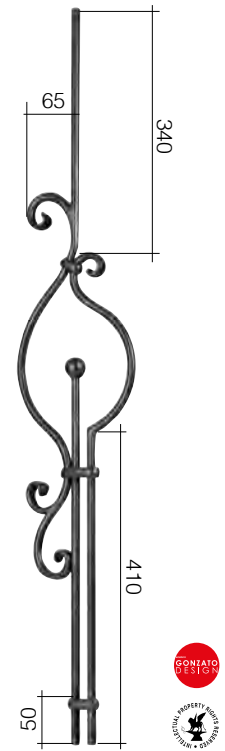

Art. GD39/3  
Ø 12 mm  
190 x 1000 mm

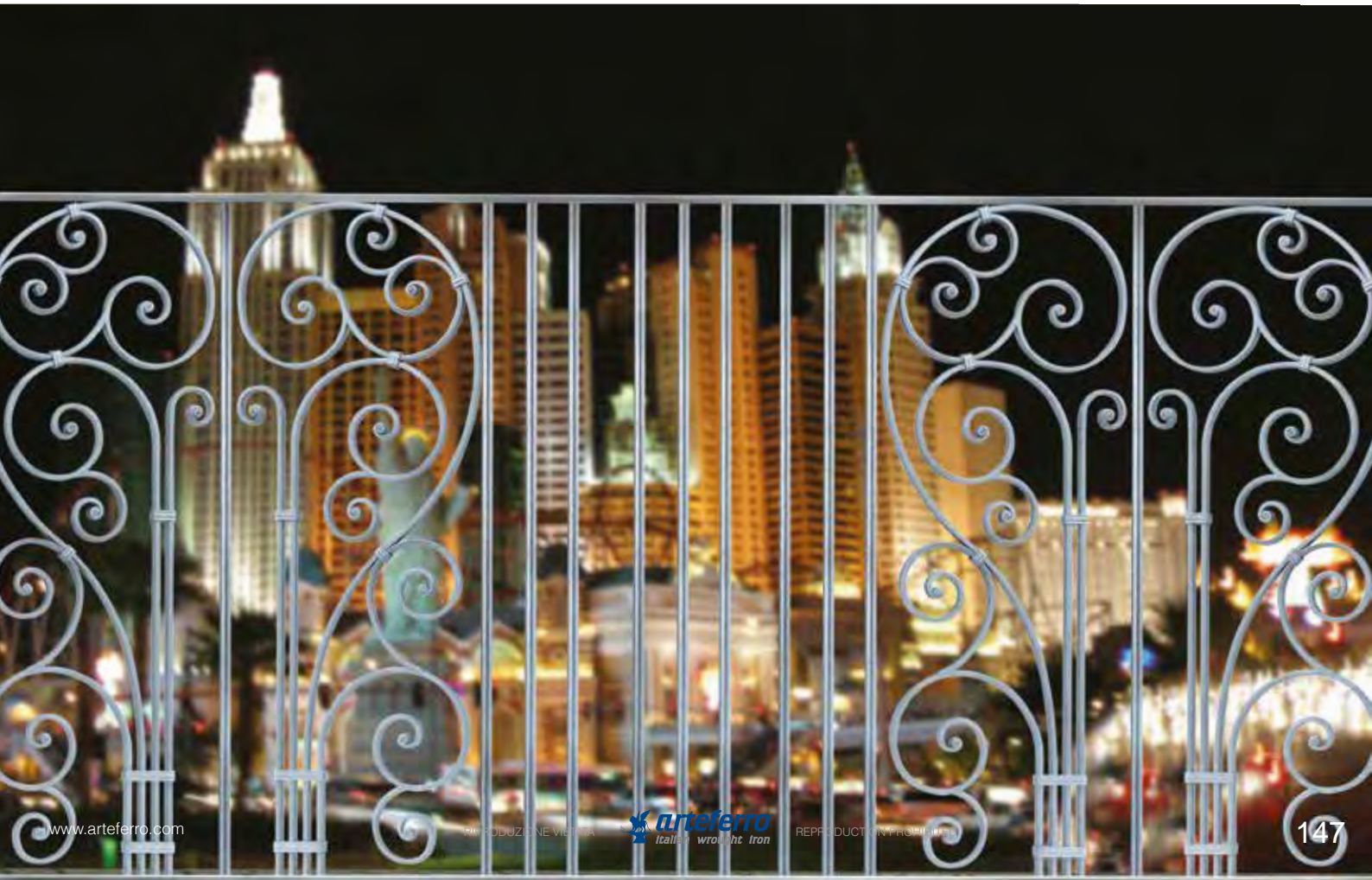

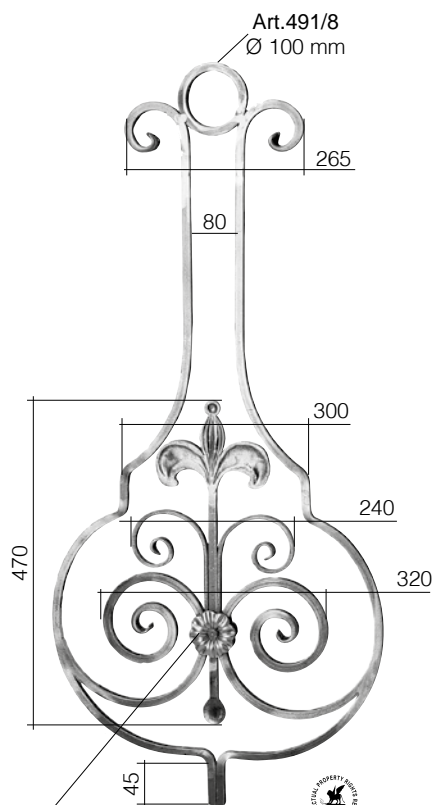

Art. 116/A/4  
on the two sides  
sui due lati

Art. 1043/2  
Ø 12 x 12 mm  
490 x 1030 mm

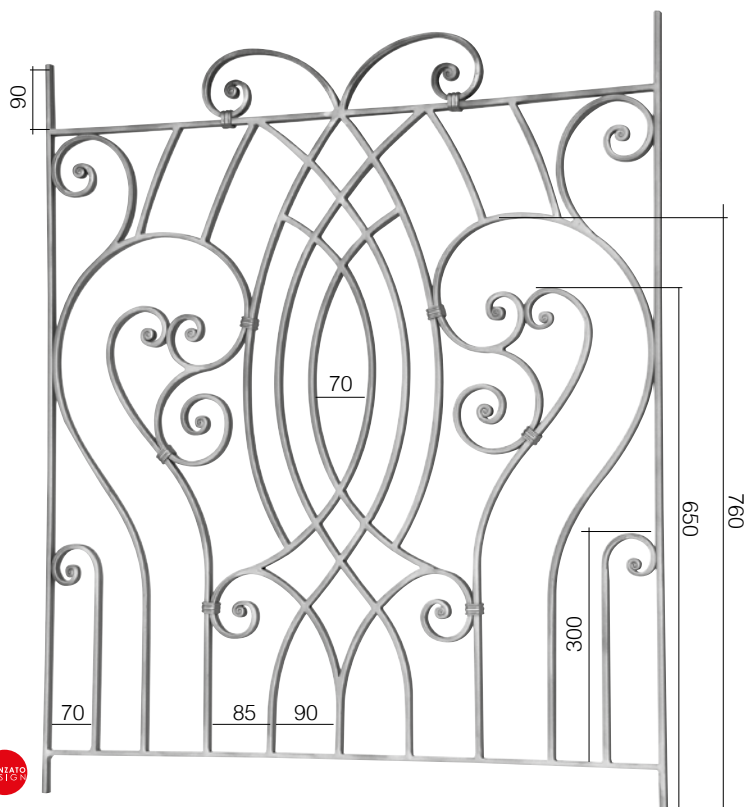

Art. GD235/1  
Ø 14 x 8 mm  
890 x 1000 mm

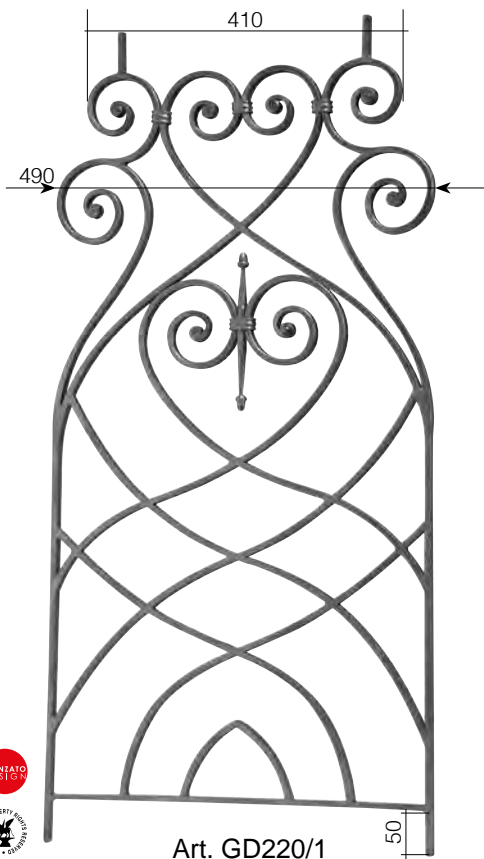

Art. GD220/1  
 Ø 14 x 8 mm  
 500 x 1000 mm

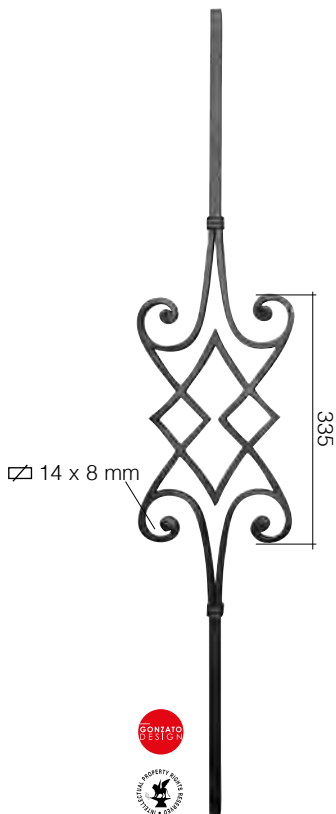

Art. GD154/3  
 Ø 14 mm  
 190 x 1000 mm





Art. 700/4/C/2

Art. GD158/1  
 ∅ 14 x 8 mm  
 160 x 1000 mm

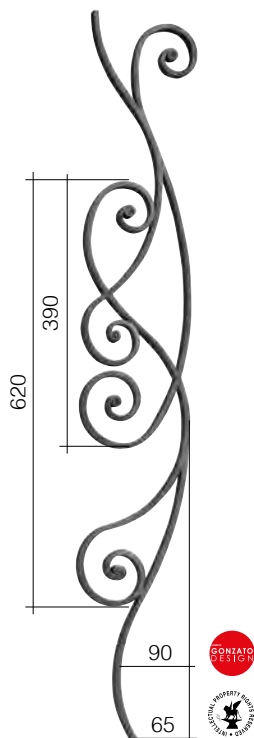

Art. GD158/2  
 ∅ 14 x 8 mm  
 160 x 1000 mm

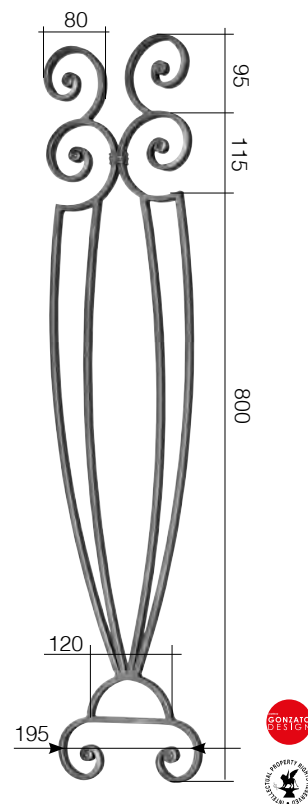

Art. GD175/7  
 ∅ 14 x 8 mm  
 200 x 1000 mm







Arteferro bowed pickets are elegant elements that allow you to create railings, fences or curved balustraded. Also made with patterns that reflect those of the pickets and panels, they can therefore be combined with each other to create compositions of refined elegance.

I pancioni Arteferro sono degli eleganti elementi che consentono di creare inferriate, recinzioni o parapetti bombati. Realizzati anche con motivi che riprendono quelli dei paletti e dei pannelli, possono quindi essere abbinati tra loro per realizzare composizioni dalla ricercata eleganza.

**BOWED PICKETS**

**PANCIONI**



Pag. 72

See also forged pickets

Vedi anche i paletti forgiati



## FORGED - FORGIATI



Art. 1783/1  
 $\varnothing$  14 x 14 mm  
 H 1000 mm



Art. 1783/2  
 $\varnothing$  14 x 14 mm  
 H 1000 mm

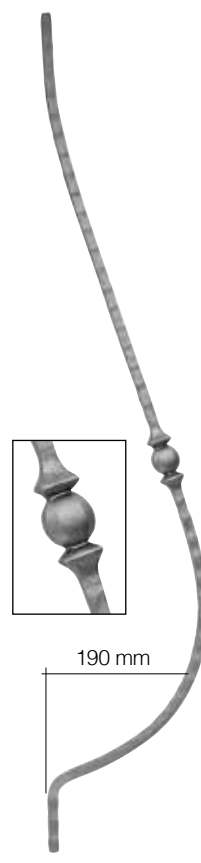

Art. 1783/5  
 $\varnothing$  12 x 12 mm  
 H 1000 mm

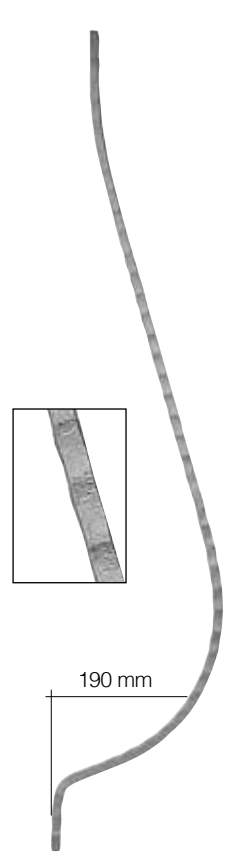

Art. 1783/6  
 $\varnothing$  12 x 12 mm  
 H 1000 mm

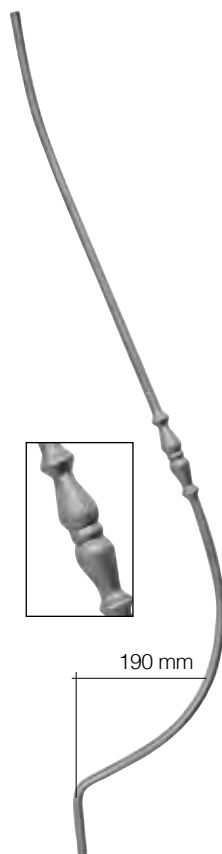

Art. 1783/3  
 $\varnothing$  12 mm  
 H 1000 mm

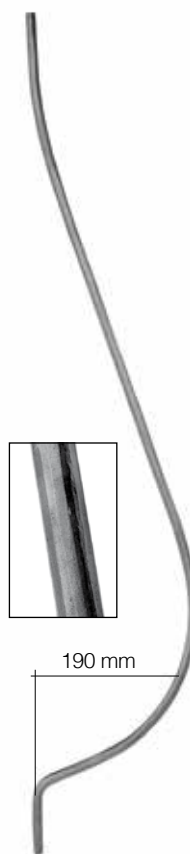

Art. 1783/4  
 $\varnothing$  12 mm  
 H 1000 mm



Art. 1783/7  
 $\varnothing$  12 mm  
 H 1000 mm

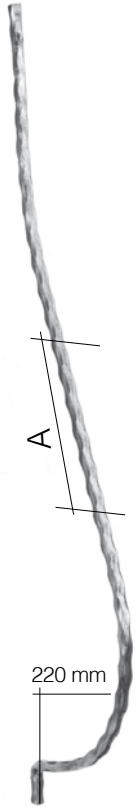
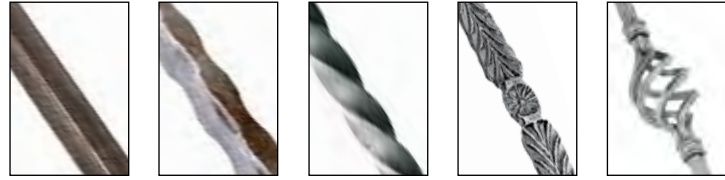

Height Altezza	Section Sezione	Art.	Art.	Plain Liscio	Hammered Spigolato	A Central twists Attorcigliat. centrale	A Hammered with one stamp Spigolato con schiacciata	A Hammered with basket Spigolato con pigna
				Art.	Art.	Art.	Art.	Art.
H 900 mm	Φ 12 x 12 mm	47/15	47/6	47/3	572/5	47/5		
	Φ 14 x 14 mm	47/16	47/12	47/9	572/7	47/11		
	Ø 12 mm	47/25	-	-	-	-		
	Ø 14 mm	47/26	-	-	-	-		
	Ø 16 mm	47/27	-	-	-	-	-	
H 1000 mm	Φ 12 x 12 mm	47/17	47/14	47/3/1000	-	47/13		
	Φ 14 x 14 mm	47/18	47/20	47/22	-	47/23		
	Ø 12 mm	47/28	-	-	-	-		
	Ø 14 mm	47/19	-	-	-	-		
	Ø 16 mm	-	-	-	-	-	-	
H 1200 mm	Φ 12 x 12 mm	47/29	47/24	47/35	572/6	-		
	Φ 14 x 14 mm	-	1158/5	-	572/8	1158/6		
	Ø 12 mm	-	-	-	-	-		
	Ø 14 mm	47/30	-	-	-	-		
	Ø 16 mm	47/31	-	-	-	-	-	
H 1500 mm	Φ 12 x 12 mm	47/32	-	47/36	-	-		
	Φ 14 x 14 mm	-	-	-	-	-		
	Ø 12 mm	-	-	-	-	-		
	Ø 14 mm	47/33	-	-	-	-		
	Ø 16 mm	47/34	-	-	-	-	-	



Infill elements  
for bowed  
pickets  
Elementi di  
tamponamento  
per pancioni



Hot forged ends  
Terminali fucinati  
a caldo

Section Sezione	L 150 mm H 350 mm Art.	L 150 mm H 350 mm Art.	L 180 mm H 360 mm Art.	L 180 mm H 360 mm Art.
Φ 12 x 12 mm	1308/12	-	1308/1	1308/3
Φ 14 x 14 mm	1308/13	-	1308/2	1308/4
Ø 14 mm	-	1308/8	1308/11	-
Ø 16 mm	-	1308/9	1308/7	-

\*Stamped like  
Stampata  
Art. 134/2

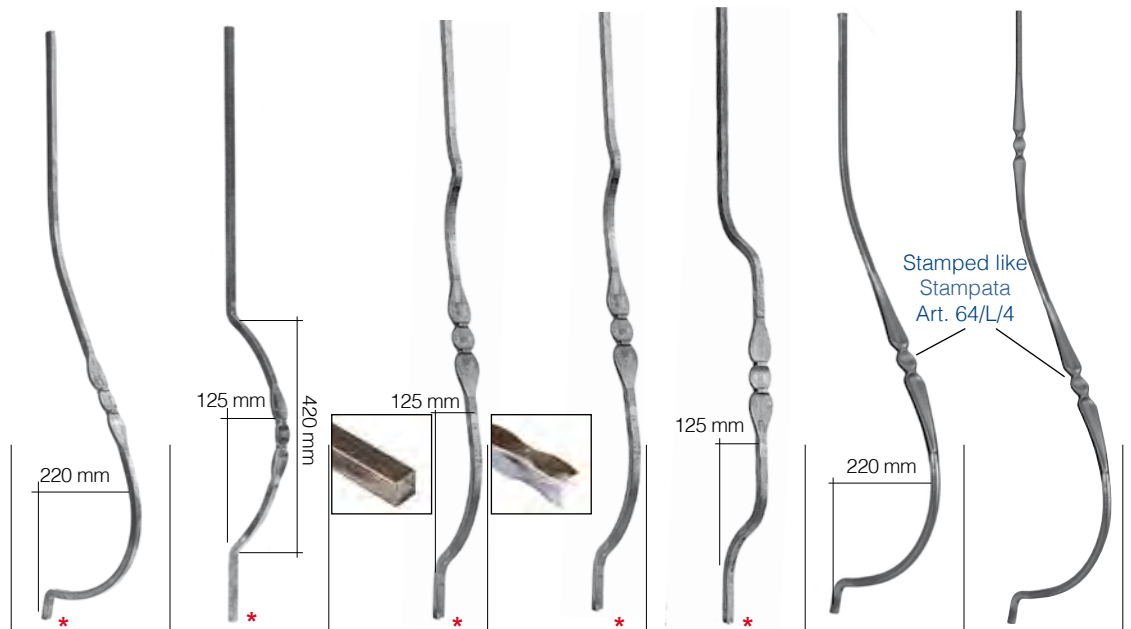

Height Altezza	Section Sezione	Art.	Art.	Art.	Art.	Art.	Art.	Art.
H 830 mm	Φ 12 x 12 mm	-	-	-	-	-	-	-
	Φ 14 x 14 mm	-	-	-	587/13	-	-	-
H 900 mm	Φ 12 x 12 mm	-	-	-	-	-	-	-
	Φ 14 x 14 mm	586/15	-	-	-	-	-	-
H 1000 mm	Φ 12 x 12 mm	586/6	586/8	587/12	-	-	-	-
	Φ 14 x 14 mm	586/7	586/9	-	-	587/24	-	-
H 1500 mm	Φ 12 x 12 mm	-	-	-	-	-	-	-
	Φ 14 x 14 mm	-	586/9/1500	-	-	-	-	-
H 1000 mm	Ø 12 mm	586/12	586/10	-	-	-	-	-
	Ø 14 mm	586/13	586/11	-	-	-	586/16	586/17



Pag.  
80

Take a look  
at our stamped  
pickets

Vai a vedere i  
paletti con  
schiacciata

Section Sezione	H 510 mm	H 1000 mm	H 1000 mm	H 1200 mm	H 1000 mm
Art.	Art.	Art.	Art.	Art.	Art.
Φ 12 x 12 mm	1264/5	1270/29	-	-	-
Φ 14 x 14 mm	-	-	1782/1	1158/8	1782/9

Section Sezione	H 820 mm	H 900 mm	H 1000 mm	H 910 mm	H 1000 mm	H 1200 mm	H 1500 mm
Art.	Art.	Art.	Art.	Art.	Art.	Art.	Art.
Φ 12 x 12 mm	-	-	-	-	-	-	-
Φ 14 x 14 mm	70/D/4	70/D/5	70/D/9	1784/1	1784/2	1784/3	1784/4
▧ 25 x 8 mm	-	1782/2	1782/4	-	-	-	-
▧ 30 x 8 mm	-	1782/3	1782/5	-	-	-	-

Height Altezza	Section Sezione	Art.
H 810 mm	Φ 12 x 12 mm	-
	Φ 14 x 14 mm	1784/5
H 910 mm	Φ 12 x 12 mm	-
	Φ 14 x 14 mm	1784/6
H 1000 mm	Φ 12 x 12 mm	1784/7/S
	Φ 14 x 14 mm	-
H 1500 mm	Φ 12 x 12 mm	-
	Φ 14 x 14 mm	1784/9

**i** Arteferro products can be manufactured as well as customised.

I prodotti Arteferro sono realizzabili anche su misura.



170 mm

125 mm



Plain  
Liscio



Hammered  
Spigolato



Bark effect  
Corteccia



Height Altezza	Section Sezione	Art.	Art.	Art.	Art.	Art.
H 1000 mm	Φ 12 x 12 mm	1701/13	1702/13	1705/13	GD273/9	GD274/9
	Φ 14 x 14 mm	1701/14	1702/14	1705/14	GD273/10	GD274/11
	Ø 12 mm	1779/13	1779/11	1779/9	-	-
	Ø 14 mm	1779/14	1779/12	1779/10	-	-

H 1000 mm	Φ 12 x 12 mm	1780/5	1780/3	1780/1	-	-
	Φ 14 x 14 mm	1780/6	1780/4	1780/2	-	-

H 1000 mm	Φ 12 x 12 mm	1780/13	1780/11	1780/9	-	-
	Φ 14 x 14 mm	1780/14	1780/12	1780/10	-	-

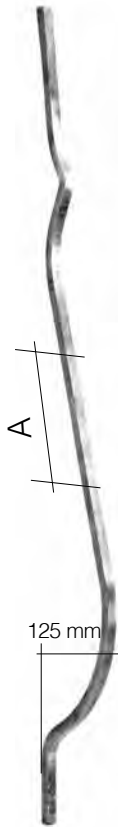

Height Altezza	Section Sezione	Art.	Art.	Art.	Art.	Art.
H 900 mm	Φ 12 x 12 mm	64/D/4	-	-	-	64/D/3
	Φ 14 x 14 mm	64/D/9 <b>BEST PRICE</b>	-	-	-	64/D/8
	Ø 12 mm	64/D/5	-	-	-	-
	Ø 14 mm	64/D/6	-	-	-	-
H 1000 mm	Φ 12 x 12 mm	1779/7	1780/7	1137/11	1780/15	64/D/7
	Φ 14 x 14 mm	1779/8	1780/8	1137/12	1780/16	64/D/10
	Ø 12 mm	1779/15	-	-	-	-
	Ø 14 mm	1779/16	-	-	-	-
H 1200 mm	Φ 12 x 12 mm	-	-	1137/13	-	-
	Φ 14 x 14 mm	-	-	1137/14	-	-

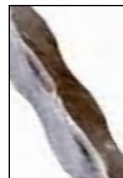

Height Altezza	Section Sezione	Art.	Art.	Art.	Art.	Art.
H 900 mm	Φ 12 x 12 mm	-	64/H/9	-	-	578/17
	Φ 14 x 14 mm	-	64/H/10	-	-	578/19
	Ø 12 mm	572/1	-	-	578/13	-
	Ø 14 mm	572/3	-	-	578/15	-
H 1000 mm	Φ 12 x 12 mm	-	64/H/9/S	1137/7	-	578/18/S1
	Φ 14 x 14 mm	-	64/H/10/S	1137/8	-	-
H 1200 mm	Φ 12 x 12 mm	-	64/H/19	1137/9	-	578/18
	Φ 14 x 14 mm	-	64/H/20	1137/10	-	578/20
	Ø 12 mm	572/2	-	-	578/14	-
	Ø 14 mm	572/4	-	-	578/16	-

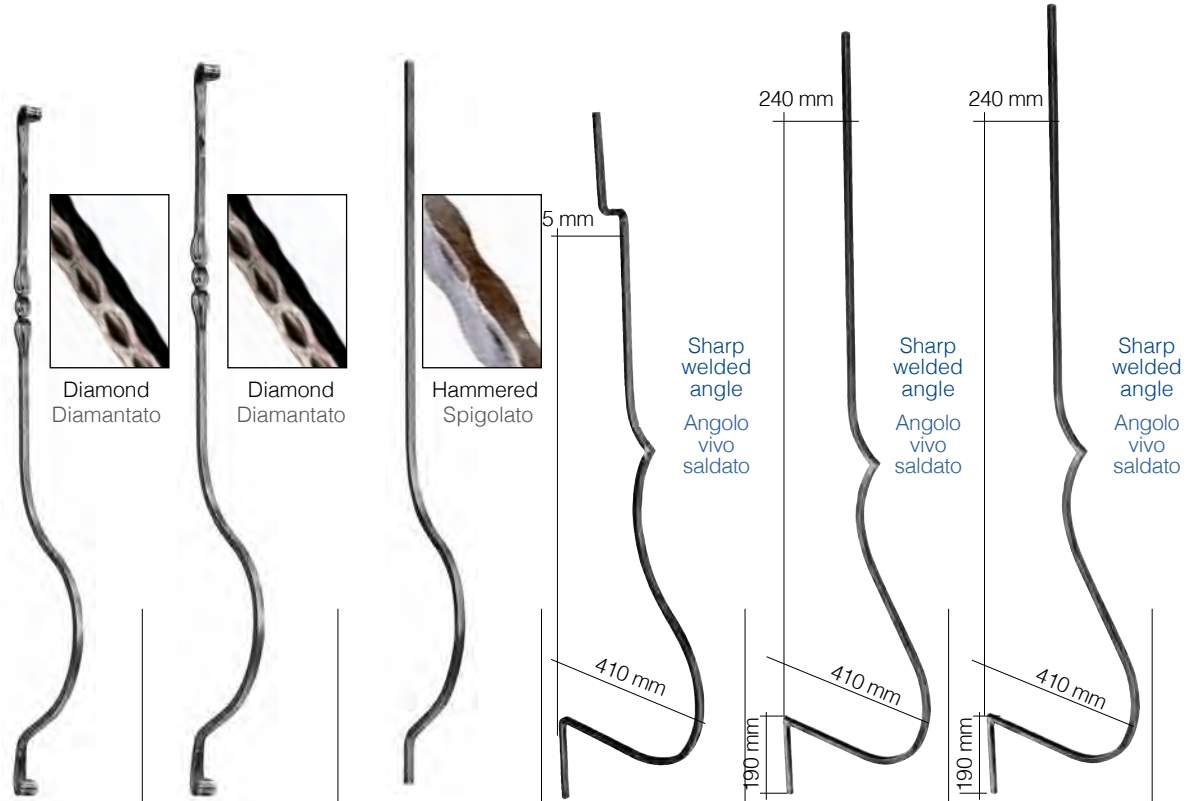

	H 1200 mm	H 1500 mm	H 1500 mm	H 1200 mm	H 1600 mm	H 1800 mm
Section Sezione	Art.	Art.	Art.	Art.	Art.	Art.
Φ 14 x 14 mm	1268/52	1268/53	1267/9	1271/5	1271/3	1271/4





**i** Arteferro products can be manufactured as well as customised.  
I prodotti Arteferro sono realizzabili anche su misura.

Bowed on the belly  
Bombati sulla pancia

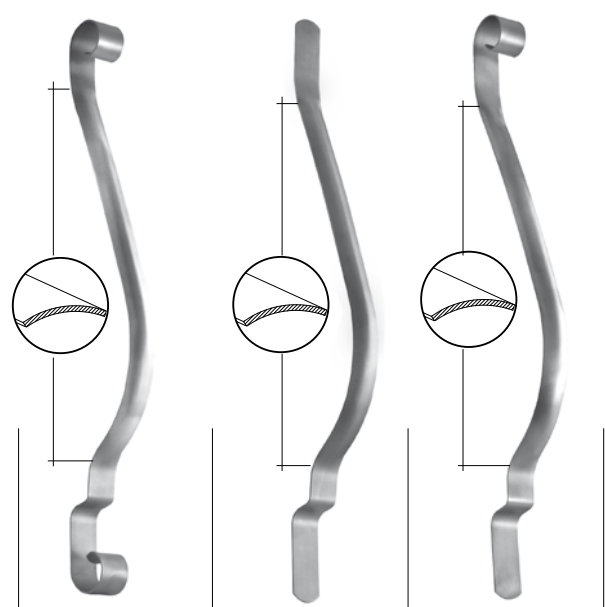

	Art.	Art.	Art.
	H 870 mm	H 900 mm	H 900 mm
Section Sezione	Art.	Art.	Art.
∅ 50 x 3 mm	46/10	46/11	46/12

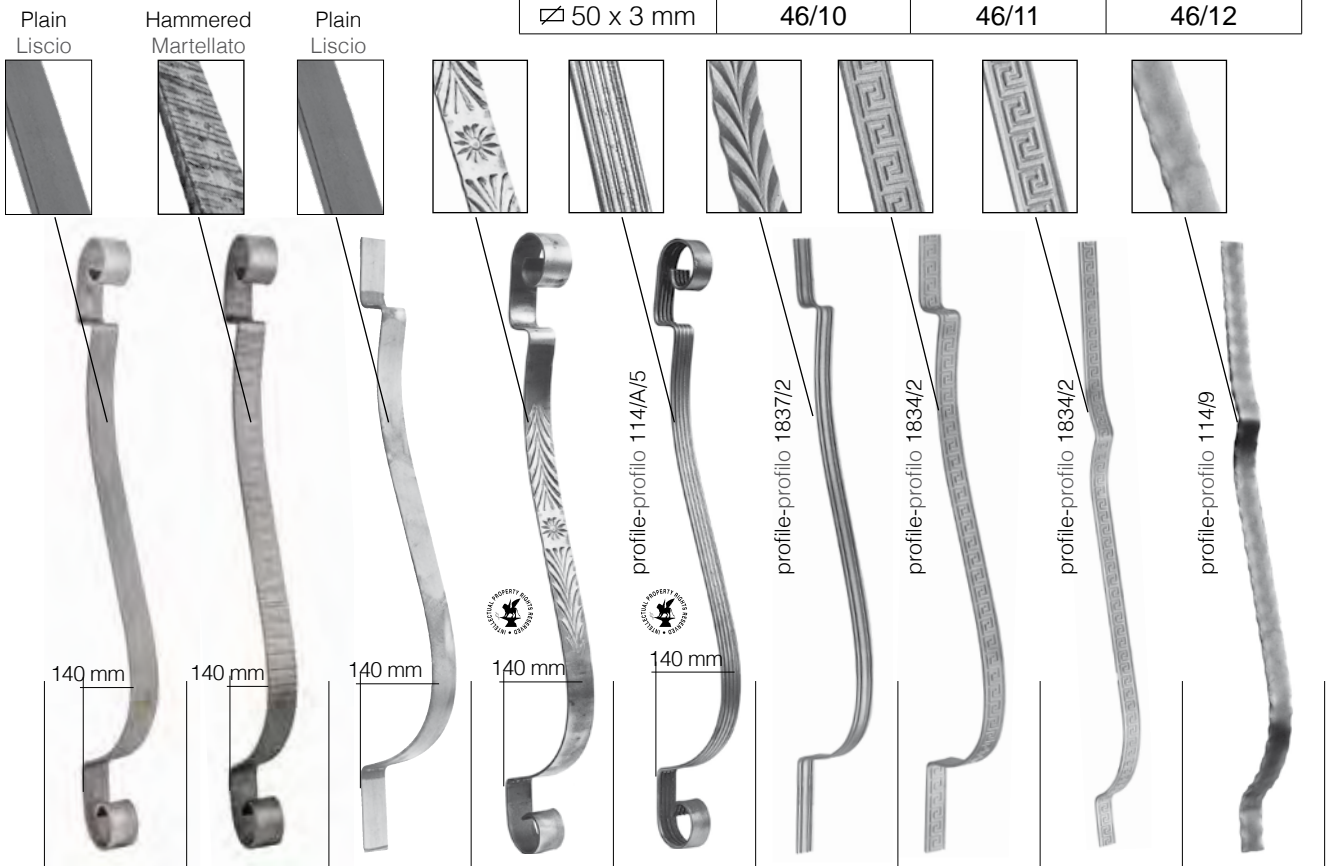

	H 800 mm	H 800 mm	H 800 mm	H 800 mm	H 800 mm	H 800 mm	H 800 mm	H 1000 mm	H 1000 mm
Section Sezione	Art.	Art.	Art.	Art.	Art.	Art.	Art.	Art.	Art.
∅ 25 x 4 mm	46/3	46/4	-	-	-	-	-	-	-
∅ 27 x 5 mm	-	-	-	-	-	1789/3	-	-	-
∅ 30 x 5 mm	-	-	-	-	1276/1	-	-	-	-
∅ 30 x 8 mm	-	-	-	-	-	-	-	-	1787/9
∅ 31 x 5 mm	-	-	-	-	-	-	1789/4	1787/4	-
∅ 40 x 4 mm	46/5	46/6	589/4	589/5	-	-	-	-	-

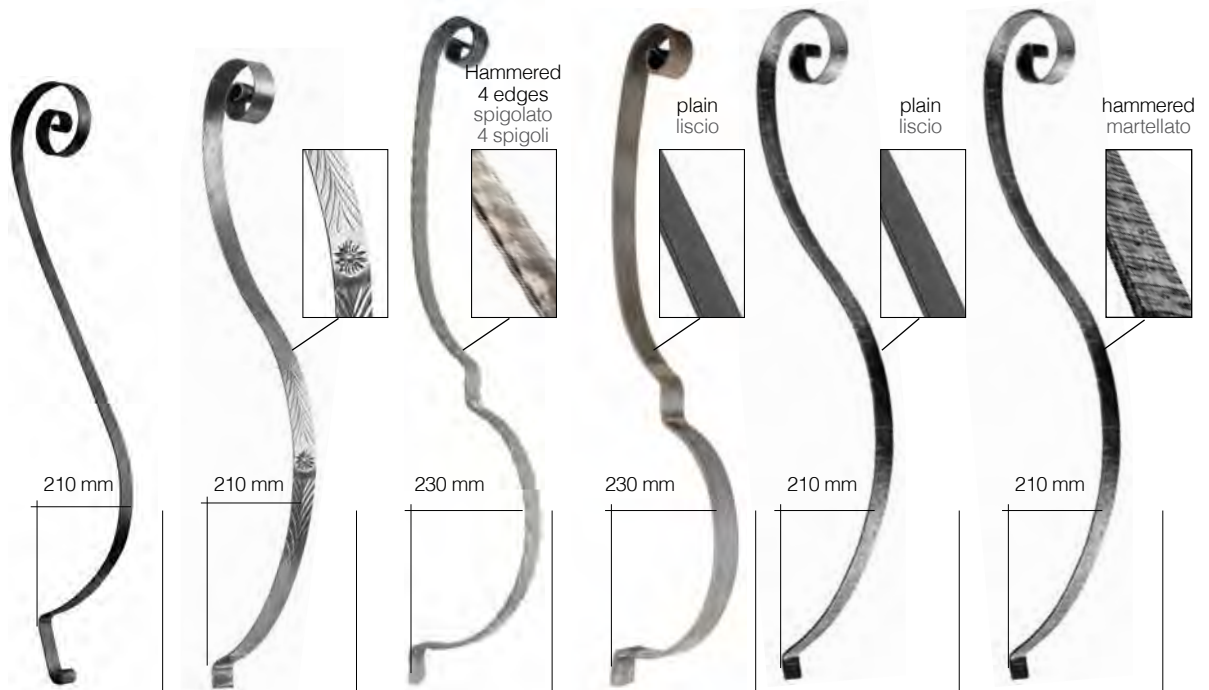

	Art.	Art.	Art.	Art.	Art.	Art.
Section Sezione	H 900 mm	H 910 mm	H 1000 mm	H 1000 mm	H 1000 mm	H 1000 mm
∅ 30 x 4 mm	1785/1	-	-	-	-	-
∅ 30 x 8 mm	-	-	44/11	44/13	-	-
∅ 40 x 4 mm	-	1785/5	-	-	45/19	45/20
∅ 40 x 8 mm	-	-	44/12	44/14	-	-
∅ 50 x 4 mm	-	-	-	-	45/21	45/22

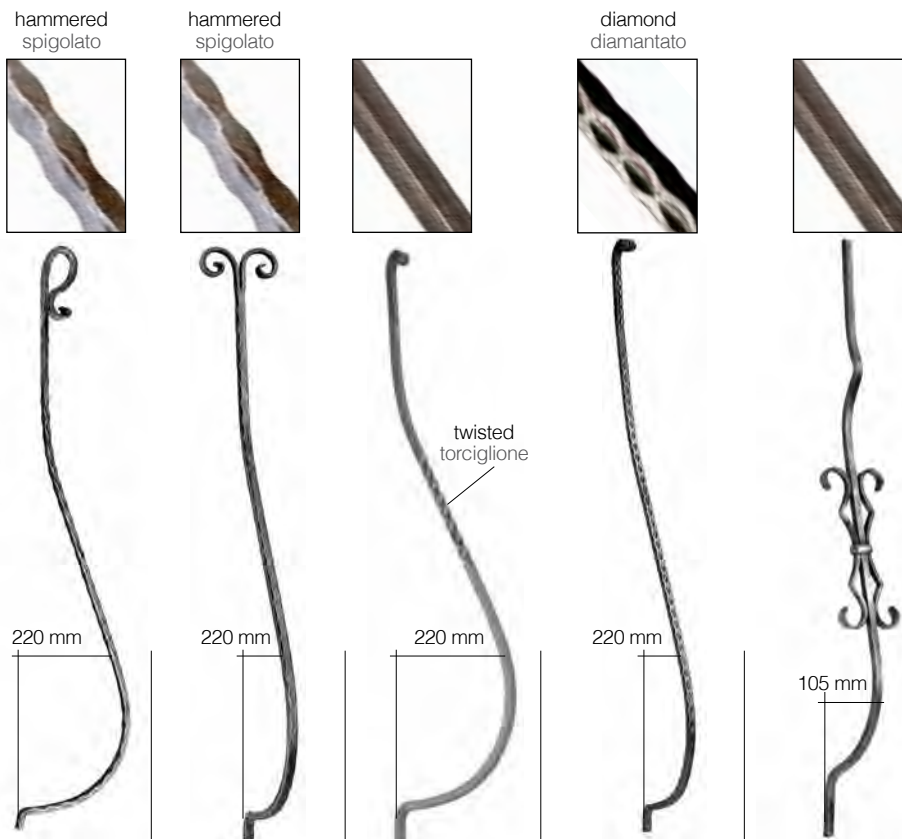

	Art.	Art.	Art.	Art.	Art.
Section Sezione	H 900 mm	H 900 mm	H 900 mm	H 900 mm	H 1000 mm
∅ 12 x 12 mm	591/3	591/1	47/4	1269/7	64/D/1
∅ 14 x 14 mm	591/4	591/2	47/10	1269/11	-



Arteferro pickets are a convenient solution for building a fence. Made with different sections, round or square, they are available in an infinite number of processes and finishes, and can be embellished with other items, like baskets, studs, scrolls, leaves or knots. Just block them with horizontal supporting elements and you're done.

I paletti per recinzione Arteferro rappresentano una comoda soluzione per la composizione di una recinzione. Realizzati con diverse sezioni, tonde o quadrate, sono disponibili in un'infinità di lavorazioni e finiture e possono essere abbelliti con altri elementi quali pigne, borchie, ricci, foglie o nodi. Basterà bloccarli con degli elementi orizzontali a sostegno ed il gioco è fatto.

# PALETTI PER RECINZIONE PICKETS FOR FENCING

7.

Pickets for fencing  
Paletti per recinzione

7.A Stamped pickets .....pag.162  
Paletti coniati

7.B Electrowelded pickets pag.171  
Paletti elettrosaldati



CHOOSE YOUR FINISH - SCEGLI LA TUA FINITURA

In a way that matches the manufacturing possibilities, Arteferro products can be customized with the following finishes

Compatibilmente con le possibilità produttive, i prodotti Arteferro si possono personalizzare con le seguenti finiture



Plain finish  
Finitura  
Liscia



Bark effect finish  
Finitura  
Corteccia



Grooved finish  
Finitura  
Rigata



Hammered finish  
Finitura  
Spigolata



Four-leaf clover finish  
Finitura  
Quadrifoglio

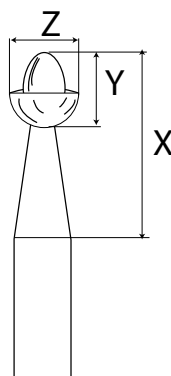
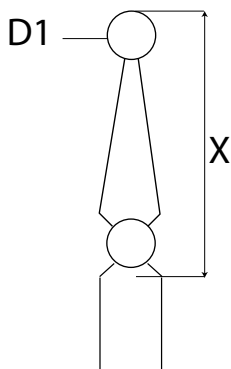

Section - Sezione	Finish - Finitura	H	Art.	Art.	Art.
$\varnothing$ 10 x 10 mm X = 68 mm D1 = $\varnothing$ 13 mm		150 mm	1758/22	-	-
		1000 mm	1758/23	1758/26	1758/29
		1200 mm	1758/24	1758/27	1758/30
		1500 mm	1758/25	1758/28	1758/31
$\varnothing$ 12 x 12 mm X = 80 mm y = $\varnothing$ 16 mm		150 mm	1758/32	-	-
		1000 mm	1758/33	1758/36	1758/39
		1200 mm	1758/34	1758/37	1758/40
		1500 mm	1758/35	1758/38	1758/41
$\varnothing$ 12 mm X = 68 mm D1 = $\varnothing$ 13 mm		150 mm	1758/1	-	-
		1000 mm	1758/2	1758/5	-
		1200 mm	1758/3	1758/6	-
		1500 mm	1758/4	1758/7	-
$\varnothing$ 14 x 14 mm X = 91 mm D1 = $\varnothing$ 18 mm		150 mm	1758/42	-	-
		1000 mm	1758/43	1758/46	1758/49
		1200 mm	1758/44	1758/47	1758/50
		1500 mm	1758/45	1758/48	1758/51
$\varnothing$ 14 mm X = 80 mm D1 = $\varnothing$ 16 mm		150 mm	1758/8	-	-
		1000 mm	1758/9	1758/12	-
		1200 mm	1758/10	1758/13	-
		1500 mm	1758/11	1758/14	-
$\varnothing$ 16 mm X = 91 mm D1 = $\varnothing$ 18 mm		150 mm	1758/15	-	-
		1000 mm	1758/16	1758/19	-
		1200 mm	1758/17	1758/20	-
		1500 mm	1758/18	1758/21	-
$\nabla$ 14 x 8 mm X = 68 mm D1 = $\varnothing$ 13 mm		150 mm	1758/52	-	-
		1000 mm	1758/53	1758/56	1758/59
		1200 mm	1758/54	1758/57	1758/60
		1500 mm	1758/55	1758/58	1758/61

Section - Sezione	Finish - Finitura	H	Art.	Art.	Art.
$\varnothing$ 10 x 10 mm X = 66 mm Y = $\varnothing$ 21 mm Z = $\varnothing$ 14 mm		150 mm	1757/29	-	-
		1000 mm	1757/30	1757/33	1757/36
		1200 mm	1757/31	1757/34	1757/37
		1500 mm	1757/32	1757/35	1757/38
$\varnothing$ 12 x 12 mm X = 55 mm Y = $\varnothing$ 23 mm Z = $\varnothing$ 16 mm		150 mm	1757/39	-	-
		1000 mm	1757/40	1757/43	1757/46
		1200 mm	1757/41	1757/44	1757/47
		1500 mm	1757/42	1757/45	1757/48
$\varnothing$ 12 mm X = 66 mm Y = $\varnothing$ 21 mm Z = $\varnothing$ 15 mm		150 mm	1757/1	-	-
		1000 mm	1757/2	1757/5	-
		1200 mm	1757/3	1757/6	-
		1500 mm	1757/4	1757/7	-
$\varnothing$ 14 x 14 mm X = 55 mm Y = $\varnothing$ 24 mm Z = $\varnothing$ 18 mm		150 mm	1757/49	-	-
		1000 mm	1757/50	1757/53	1757/56
		1200 mm	1757/51	1757/54	1757/57
		1500 mm	1757/52	1757/55	1757/58
$\varnothing$ 14 mm X = 55 mm Y = $\varnothing$ 23 mm Z = $\varnothing$ 16 mm		150 mm	1757/8	-	-
		1000 mm	1757/9	1757/12	-
		1200 mm	1757/10	1757/13	-
		1500 mm	1757/11	1757/14	-
$\varnothing$ 16 x 16 mm X = 60 mm Y = $\varnothing$ 29 mm Z = $\varnothing$ 20 mm		150 mm	1757/59	-	-
		1000 mm	1757/60	1757/63	1757/66
		1200 mm	1757/61	1757/64	1757/67
		1500 mm	1757/62	1757/65	1757/68
$\varnothing$ 16 mm X = 55 mm Y = $\varnothing$ 24 mm Z = $\varnothing$ 18 mm		150 mm	1757/15	-	-
		1000 mm	1757/16	1757/19	-
		1200 mm	1757/17	1757/20	-
		1500 mm	1757/18	1757/21	-
$\varnothing$ 18 mm X = 60 mm Y = $\varnothing$ 29 mm Z = $\varnothing$ 20 mm		150 mm	1757/22	-	-
		1000 mm	1757/23	1757/26	-
		1200 mm	1757/24	1757/27	-
		1500 mm	1757/25	1757/28	-
$\nabla$ 14 x 8 mm X = 66 mm Y = $\varnothing$ 21 mm Z = $\varnothing$ 15 mm		150 mm	1757/69	-	-
		1000 mm	1757/70	1757/73	1757/76
		1200 mm	1757/71	1757/74	1757/77
		1500 mm	1757/72	1757/75	1757/78

**i** Arterferro products can be manufactured as well as customised.  
I prodotti Arterferro sono realizzabili anche su misura.

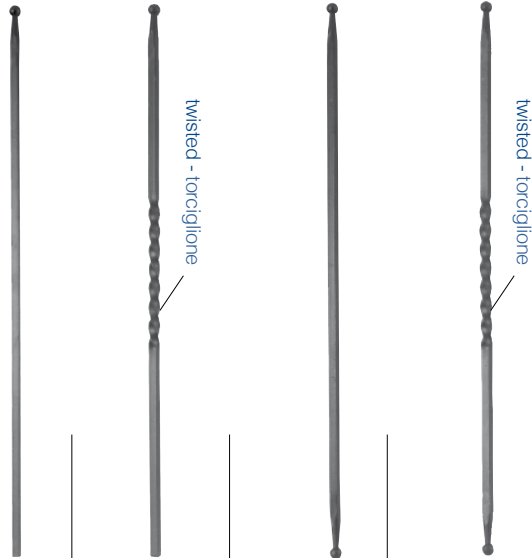
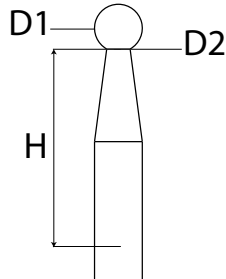

Section - Sezione	Finish - Finitura	H	Art.	Art.	Art.	Art.
$\Phi$ 12 x 12 mm H = 31 mm D1 = 16 mm D2 = 7,6 mm	Plain - Liscio 	200 mm	118/C/63	-	-	-
		700 mm	118/C/9	118/C/5	118/C/21	118/C/14
		900 mm	118/C/10	118/C/6	118/C/22	118/C/15
		1000 mm	118/C/33	118/C/28	118/C/23	118/C/16
		1200 mm	118/C/53	118/C/28/1200	118/C/23/1200	118/C/16/1200
		1500 mm	118/C/54	-	-	-
$\Phi$ 12 mm H = 28 mm D1 = 12 mm D2 = 6,1 mm	Plain - Liscio 	200 mm	118/C/66	-	-	-
		700 mm	118/C/45	-	118/C/37	-
		900 mm	118/C/46	-	118/C/38	-
		1000 mm	118/C/47	-	118/C/39	-
		1200 mm	118/C/58	-	118/C/39/1200	-
$\Phi$ 14 x 14 mm H = 37 mm D1 = 18 mm D2 = 9,8 mm	Plain - Liscio 	200 mm	118/C/64	-	-	-
		700 mm	118/C/11	118/C/7	118/C/3	118/C/1
		900 mm	118/C/12	118/C/8	118/C/4	118/C/2
		1000 mm	118/C/32	118/C/27	118/C/20	118/C/13
		1200 mm	118/C/55	118/C/27/1200	118/C/20/1200	118/C/13/1200
$\Phi$ 14 mm H = 28 mm D1 = 16 mm D2 = 6,9 mm	Plain - Liscio 	200 mm	118/C/67	-	-	-
		700 mm	118/C/48	-	118/C/40	-
		900 mm	118/C/49	-	118/C/41	-
		1000 mm	118/C/50	-	118/C/42	-
		1200 mm	118/C/60	-	118/C/42/1200	-
$\Phi$ 16 x 16 mm H = 45 mm D1 = 20 mm D2 = 6,1 mm	Plain - Liscio 	200 mm	118/C/65	-	-	-
		700 mm	118/C/72	118/C/7/Q16	118/C/106	118/C/1/Q16
		900 mm	118/C/34	118/C/29	118/C/24	118/C/17
		1000 mm	118/C/35	118/C/30	118/C/25	118/C/18
		1200 mm	118/C/36	118/C/31	118/C/26	118/C/19
$\Phi$ 16 mm H = 25,6 mm D1 = 18 mm D2 = 9,7 mm	Plain - Liscio 	200 mm	118/C/68	-	-	-
		700 mm	118/C/96	-	118/C/40/T16	-
		900 mm	118/C/97	-	118/C/43	-
		1000 mm	118/C/51	-	118/C/44	-
		1200 mm	118/C/52	-	118/C/44/1200	-
1500 mm	118/C/62	-	-	-		

Diam.	H	Plain	Hammered	Sec.- Sez.	H	Art.
		Liscio	Spigolato			
$\Phi$ 25 x 25 mm	200 mm	1382/2	1382/6	$\Phi$ 25 mm	200 mm	1382/4
	1000 mm	42/B/5	-		1000 mm	-
	1200 mm	42/B/6	-		1200 mm	-
$\Phi$ 30 x 30 mm	200 mm	1382/3	1382/7	$\Phi$ 30 mm	200 mm	1382/5
	1000 mm	42/B/7	-		1000 mm	-
	1200 mm	42/B/8	-		1200 mm	-
$\Phi$ 40 x 40 mm	200 mm	1382/1	1382/8	$\Phi$ 40 mm	200 mm	-
	1000 mm	-	-		1000 mm	-
	1200 mm	-	-		1200 mm	-

Newel Post - Caposaldo



pyramid spear point - punta piramidale



conic spear point - punta conica

Plain  
Liscio Hammered  
Spigolato Plain  
Liscio 

H	Section Sezione	Art.	Art.	Art.
300 mm	12 mm	132/C/12	-	132/C/18
	14 mm	132/C/13	-	132/C/19
	16 mm	132/C/14	-	132/C/20
	18 mm	-	-	-
	20 mm	132/C/15	-	132/C/21
	22 mm	-	-	-
	25 mm	132/C/16	-	132/C/22
	30 mm	132/C/17	-	132/C/23
900 mm	12 mm	132/B/37	132/B/46	132/C/1
	14 mm	132/B/40	132/B/49	132/C/4
	16 mm	132/B/43	132/B/52	132/C/7
	18 mm	-	-	-
	20 mm	-	-	-
	22 mm	-	-	-
	25 mm	-	-	-
	30 mm	-	-	-
1000 mm	12 mm	-	-	132/C/32
	14 mm	132/D/1	-	132/D/11
	16 mm	132/D/3	-	132/D/13
	18 mm	132/D/5	-	132/D/15
	20 mm	132/D/8	-	132/D/18
	22 mm	-	-	-
	25 mm	-	-	-
	30 mm	-	-	-
1200 mm	12 mm	132/B/38	132/B/47	132/C/2
	14 mm	132/B/41	132/B/50	132/C/5
	16 mm	132/B/44	132/B/53	132/C/8
	18 mm	-	-	-
	20 mm	-	-	-
	22 mm	-	-	-
	25 mm	-	-	-
	30 mm	-	-	-
1500 mm	12 mm	132/B/39	132/B/48	132/C/3
	14 mm	132/B/42	132/B/51	132/C/6
	16 mm	132/B/45	132/B/54	132/C/9
	18 mm	132/D/6	-	132/D/16
	20 mm	132/D/9	-	132/D/19
	22 mm	-	-	132/C/28
	25 mm	-	-	132/C/10
	30 mm	-	-	-
2000 mm	12 mm	-	-	-
	14 mm	132/D/2	-	132/D/12
	16 mm	132/D/4	-	132/D/14
	18 mm	132/D/7	132/B/83	132/D/17
	20 mm	132/D/10	132/B/84	132/D/20
	22 mm	-	-	132/C/29
	25 mm	-	-	-
	30 mm	-	-	-



pyramid spear point - punta piramidale



Arteferro products can be manufactured as well as customised.

I prodotti Arteferro sono realizzabili anche su misura.







H	Section Sezione	Art.	Art.
900 mm	12 mm	132/B/55	132/B/64
	14 mm	132/B/58	132/B/67
	16 mm	132/B/61	132/B/70
1200 mm	12 mm	132/B/56	132/B/65
	14 mm	132/B/59	132/B/68
	16 mm	132/B/62	132/B/71
1500 mm	12 mm	132/B/57	132/B/66
	14 mm	132/B/60	132/B/69
	16 mm	132/B/63	132/B/72
2000 mm	18 mm	132/B/85	132/B/87
	20 mm	132/B/86	132/B/88



Arteferro products can be manufactured as well as customised.

I prodotti Arteferro sono realizzabili anche su misura.



Section - Sezione	Finish - Finitura	H	Art.	Art.	Art.
Ø 12 x 12 mm	 Plain Liscio	100 mm	129/6	-	-
		200 mm	-	129/2	129/4
		800 mm	130/51	130/21	130/11
		900 mm	130/52	130/22	130/12
		1000 mm	130/53	130/23	130/13
		1200 mm	130/54	130/24	130/14
		1500 mm	130/55	130/25	130/15
Ø 12 mm	 Plain Liscio	100 mm	-	-	-
		200 mm	1080/9/200	-	-
		800 mm	1080/9/S3	-	-
		900 mm	1080/9/S8	-	-
		1000 mm	1080/9	-	-
		1200 mm	1080/9/S1	-	-
		1500 mm	1080/9/S9	-	-
Ø 14 x 14 mm	 Plain Liscio	100 mm	129/5	-	-
		200 mm	-	129/1	129/3
		800 mm	130/56	130/26	130/16
		900 mm	130/57	130/27	130/17
		1000 mm	130/58	130/8	130/18
		1200 mm	130/59	130/29	130/19
		1500 mm	130/60	130/30	130/20
Ø 14 mm	 Plain Liscio	100 mm	-	-	-
		200 mm	1080/9/S14	-	-
		800 mm	1080/9/S10	-	-
		900 mm	1080/9/S11	-	-
		1000 mm	1080/9/S12	-	-
		1200 mm	1080/9/S13	-	-
		1500 mm	1080/9/S4	-	-



⌀ 20 mm  
⌀ 30 mm

Top for post  
Punta per caposaldo

Sec.-Sez.	Art.	H	H1	L1
⌀ 20 mm	129/17	250 mm	147 mm	60 mm
⌀ 30 mm	129/18	250 mm	165 mm	72 mm

Sec.-Sez.	A		B		
	H1	L1	H1	L1	D=Ø
⌀ 12 mm	115 mm	43 mm	132 mm	43 mm	16 mm
Ø 12 mm	115 mm	40 mm	125 mm	40 mm	14 mm
⌀ 14 mm	128 mm	50 mm	143 mm	50 mm	16 mm
Ø 14 mm	125 mm	45 mm	140 mm	45 mm	16 mm

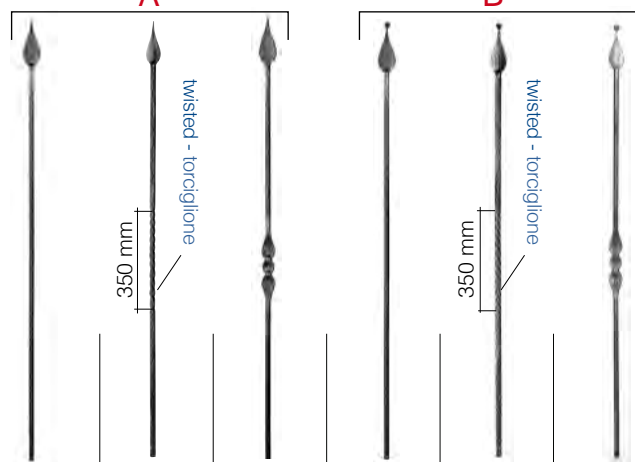

Section - Sezione	Finish - Finitura	H	Art.	Art.	Art.	Art.	Art.	Art.
⌀ 12 x 12 mm	Plain - Liscio	200 mm	129/10	-	-	722/5	-	-
		800 mm	130/31	-	-	-	-	-
		900 mm	130/32	-	-	-	-	-
		1000 mm	130/33	-	1263/27	1263/13	-	1263/19
		1200 mm	130/34	-	1263/29	1263/15	-	1263/21
	Bark effect - Corteccia	1500 mm	130/35	-	1263/31	1263/17	-	1263/23
		1000 mm	1261/31	1261/25	1261/19	1260/31	1260/25	1260/19
		1200 mm	1261/33	1261/27	1261/21	1260/33	1260/27	1260/21
		1500 mm	1261/35	1261/29	1261/23	1260/35	1260/29	1260/23
Four-leaf clover - Quadrifoglio	1000 mm	-	-	-	-	-	-	
	1200 mm	-	-	-	-	-	-	
	1500 mm	-	-	-	-	-	-	
Ø 12 mm	Plain - Liscio	200 mm	1385/7	-	-	1385/13	-	-
		1000 mm	1262/37	-	1262/43	1262/13	-	1262/19
		1200 mm	1262/39	-	1262/45	1262/15	-	1262/21
		1500 mm	1262/41	-	1262/47	1262/17	-	1262/23
⌀ 14 x 14 mm	Plain - Liscio	200 mm	129/9	-	-	722/6	-	-
		800 mm	130/36	-	-	-	-	-
		900 mm	130/37	-	-	-	-	-
		1000 mm	130/38	-	1263/28	1263/14	-	1263/20
		1200 mm	130/39	-	1263/30	1263/16	-	1263/22
	Four-leaf clover - Quadrifoglio	1500 mm	130/40	-	1263/32	1263/18	-	1263/24
		1000 mm	1261/32	1261/26	1261/20	1260/32	1260/26	1260/20
Ø 14 mm	Plain - Liscio	1200 mm	1261/34	1261/28	1261/22	1260/34	1260/28	1260/22
		1500 mm	1261/36	1261/30	1261/24	1260/36	1260/30	1260/24
		200 mm	1385/8	-	-	1385/14	-	-
		1000 mm	1262/38	-	1262/44	1262/14	-	1262/20
		1200 mm	1262/40	-	1262/46	1262/16	-	1262/22
		1500 mm	1262/42	-	1262/48	1262/18	-	1262/24



Sec.-Sez.	C		D		
	H1	L1	H1	L1	D=Ø
∅ 12 mm	145 mm	43 mm	132 mm	43 mm	16 mm
∅ 12 mm	145 mm	40 mm	150 mm	40 mm	14 mm
∅ 14 mm	156 mm	50 mm	143 mm	50 mm	16 mm
∅ 14 mm	145 mm	45 mm	163 mm	45 mm </td <td>16 mm</td>	16 mm

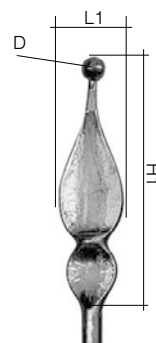

**i** Arterferro products can be manufactured as well as customised.  
I prodotti Arterferro sono realizzabili anche su misura.

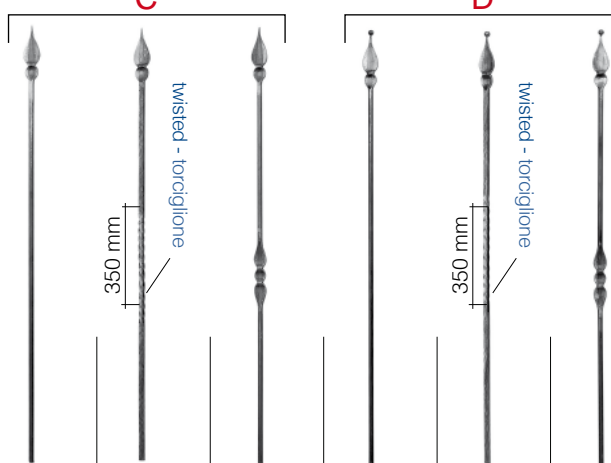

Section - Sezione	Finish - Finitura	H	Art.	Art.	Art.	Art.	Art.	Art.
∅ 12 x 12 mm	Plain - Liscio	200 mm	129/8	-	-	722/3	-	-
		800 mm	130/1	-	134/17	-	-	-
		900 mm	130/2	-	-	-	-	-
		1000 mm	130/3	-	134/18	1263/1	-	1263/7
		1200 mm	130/4	-	134/19	1263/3	-	1263/9
	Bark effect - Corteccia	1500 mm	130/5	-	1263/25	1263/5	-	1263/11
		1000 mm	1261/49	1261/43	1261/37	1260/49	1260/43	1260/37
		1200 mm	1261/51	1261/45	1261/3	1260/51	1260/45	1260/39
		1500 mm	1261/53	1261/47	1261/41	1260/53	1260/47	1260/41
Four-leaf clover - Quadrifoglio	1000 mm	1261/67	1261/61	1261/55	1260/67	1260/61	1260/55	
	1200 mm	1261/69	1261/63	1261/57	1260/69	1260/63	1260/57	
	1500 mm	1261/71	1261/65	1261/59	1260/71	1260/65	1260/59	
∅ 12 mm	Plain - Liscio	200 mm	1385/4	-	-	1385/10	-	-
		1000 mm	1262/25	-	1262/31	1262/1	-	1262/7
		1200 mm	1262/27	-	1262/33	1262/3	-	1262/9
		1500 mm	1262/29	-	1262/35	1262/5	-	1262/11
∅ 14 x 14 mm	Plain - Liscio	200 mm	129/7	-	-	722/4	-	-
		800 mm	130/6	-	134/20	-	-	-
		900 mm	130/7	-	-	-	-	-
		1000 mm	130/8	-	134/21	1263/2	-	1263/8
		1200 mm	130/9	-	134/22	1263/4	-	1263/10
	Four-leaf clover - Quadrifoglio	1500 mm	130/10	-	1263/26	1263/6	-	1263/12
		1000 mm	1261/50	1261/44	1261/38	1260/50	1260/44	1260/38
		1200 mm	1261/52	1261/46	1261/40	1260/52	1260/46	1260/40
		1500 mm	1261/54	1261/48	1261/42	1260/54	1260/48	1260/42
∅ 14 mm	Plain - Liscio	200 mm	1385/5	-	-	1385/11	-	-
		1000 mm	1262/26	-	1262/32	1262/2	-	1262/8
		1200 mm	1262/28	-	1262/34	1262/4	-	1262/10
		1500 mm	1262/30	-	1262/36	1262/6	-	1262/12

A

Sec.-Sez.	H1	H2	L1	L2
∅ 12 mm	165 mm	105 mm	46 mm	98 mm
∅ 14 mm	185 mm	125 mm	52 mm	104 mm

B

H1	H2	L1	L2	D=∅
180 mm	120 mm	46 mm	98 mm	16 mm
200 mm	145 mm	52 mm	104 mm	16 mm



Arteferro products can be manufactured as well as customised.

I prodotti Arteferro sono realizzabili anche su misura.

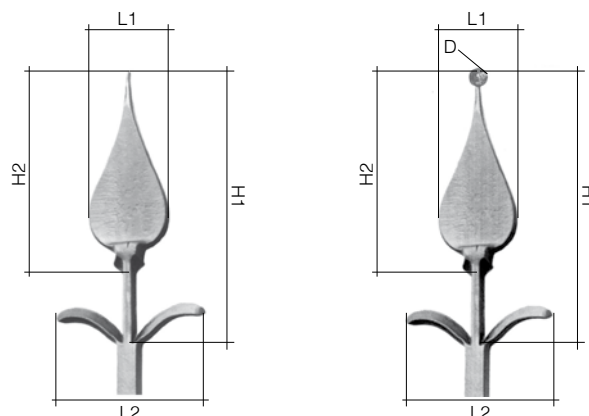

A

B

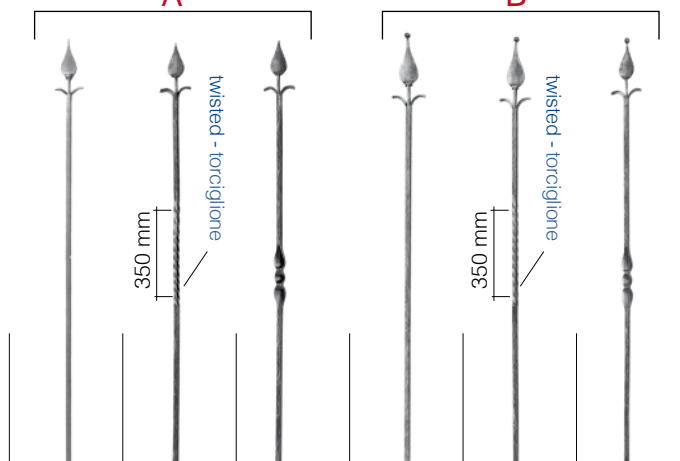

Section - Sezione	Finish - Finitura	H	Art.	Art.	Art.	Art.	Art.	Art.
∅ 12 x 12 mm	Plain - Liscio 	200 mm	129/12	-	-	722/1	-	-
		230 mm	-	-	-	-	-	-
		800 mm	130/41	-	-	-	-	-
		900 mm	130/42	-	-	-	-	-
		1000 mm	130/43	-	-	-	-	-
		1200 mm	130/44	-	-	-	-	-
	1500 mm	130/45	-	-	-	-	-	
	Bark effect - Corteccia 	1000 mm	1261/13	1261/7	1261/1	1260/13	1260/7	1260/1
		1200 mm	1261/15	1261/9	1261/3	1260/15	1260/9	1260/3
1500 mm		1261/17	1261/11	1261/5	1260/17	1260/11	1260/5	
∅ 14 x 14 mm	Plain - Liscio 	200 mm	-	-	-	-	-	-
		230 mm	129/11	-	-	722/2	-	-
		800 mm	130/46	-	-	-	-	-
		900 mm	130/47	-	-	-	-	-
		1000 mm	130/48	-	-	-	-	-
		1200 mm	130/49	-	-	-	-	-
	1500 mm	130/50	-	-	-	-	-	
	Bark effect - Corteccia 	1000 mm	1261/14	1261/8	1261/2	1260/14	1260/8	1260/2
		1200 mm	1261/16	1261/10	1261/4	1260/16	1260/10	1260/4
1500 mm		1261/18	1261/12	1261/6	1260/18	1260/12	1260/6	

**i** Arterferro products can be manufactured as well as customised.  
I prodotti Arterferro sono realizzabili anche su misura.

**A**

Sec.-Sez.	H1	L1
⌀ 12 mm	75 mm	35 mm
Ø 12 mm	77 mm	33 mm
⌀ 14 mm	87 mm	41 mm
Ø 14 mm	86 mm	38 mm
⌀ 16 mm	95 mm	46 mm
Ø 16 mm	92 mm	43 mm

**B**

H1	L1	D1=Ø	D2=Ø
85 mm	35 mm	14 mm	6 mm
80 mm	35 mm	14 mm	6 mm
85 mm	39 mm	18 mm	7 mm
85 mm	37 mm	16 mm	7 mm
105 mm	46 mm	21 mm	7 mm
100 mm	42 mm	18 mm	7 mm

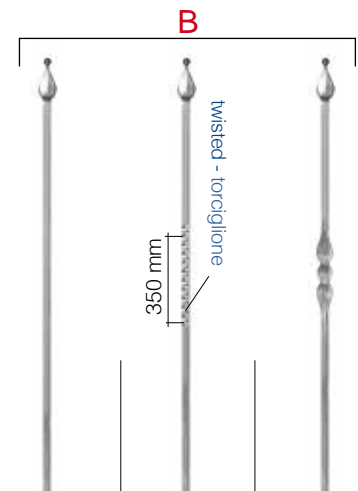
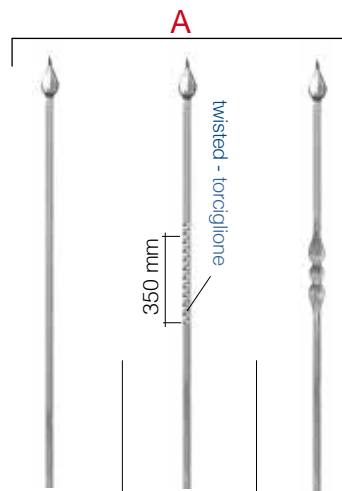
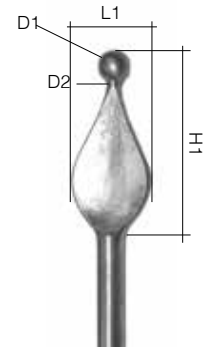

Section - Sezione	Finish - Finitura	H	Art.	Art.	Art.	Art.	Art.	Art.
⌀ 12 x 12 mm		150 mm	1764/73	-	-	1764/43	-	-
		1000 mm	1764/76	1764/94	1764/85	1764/46	1764/64	1764/55
		1200 mm	1764/79	1764/97	1764/88	1764/49	1764/67	1764/58
		1500 mm	1764/82	1764/100	1764/91	1764/52	1764/70	1764/61
Ø 12 mm		150 mm	1764/22	-	1764/34	1764/1	-	-
		1000 mm	1764/25	-	1764/37	1764/4	-	1764/13
		1200 mm	1764/28	-	1764/40	1764/7	-	1764/16
		1500 mm	1764/31	-	-	1764/10	-	1764/19
⌀ 14 x 14 mm		150 mm	1764/74	-	-	1764/44	-	-
		1000 mm	1764/77	1764/95	1764/86	1764/47	1764/65	1764/56
		1200 mm	1764/80	1764/98	1764/89	1764/50	1764/68	1764/59
		1500 mm	1764/83	1764/101	1764/92	1764/53	1764/71	1764/62
Ø 14 mm		150 mm	1764/23	-	-	1764/2	-	-
		1000 mm	1764/26	-	1764/35	1764/5	-	1764/14
		1200 mm	1764/29	-	1764/38	1764/8	-	1764/17
		1500 mm	1764/32	-	1764/41	1764/11	-	1764/20
⌀ 16 x 16 mm		150 mm	1764/75	-	-	1764/45	-	-
		1000 mm	1764/78	1764/96	1764/87	1764/48	1764/66	1764/57
		1200 mm	1764/81	1764/99	1764/90	1764/51	1764/69	1764/60
		1500 mm	1764/84	1764/102	1764/93	1764/54	1764/72	1764/63
Ø 16 mm		150 mm	1764/24	-	-	1764/3	-	-
		1000 mm	1764/27	-	1764/36	1764/6	-	1764/15
		1200 mm	1764/30	-	1764/39	1764/9	-	1764/18
		1500 mm	1764/33	-	1764/42	1764/12	-	1764/21

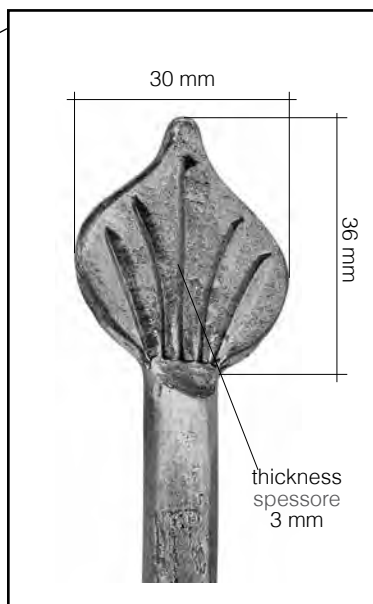

Section - Sezione	Finish - Finitura	H	Art.
Ø 10 mm	Plain - Liscio 	150 mm	1722/1
		800 mm	1722/2
		1000 mm	1722/3
		1200 mm	1722/4



Electrowelded pickets - Paletti elettrosaldati

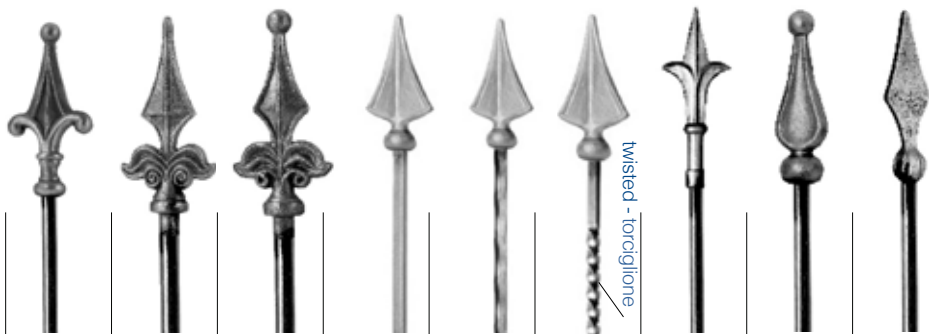

Sec. - Sez.	Finish - Finitura	H	Art.	Art.	Art.	Art.	Art.	Art.	Art.	Art.	Art.
Ø 12 x 12 mm	Plain - Liscio	1000 mm	-	-	-	727/24	-	727/26	-	-	-
		1200 mm	-	-	-	727/27	-	727/29	-	-	-
	Hammered - Spigolato	1000 mm	-	-	-	-	727/25	-	-	-	-
		1200 mm	-	-	-	-	727/28	-	-	-	-
Ø 12 mm	Plain - Liscio	1000 mm	1855/11	1855/23	1855/25	-	-	-	124/11	727/34	726/20
		1200 mm	1855/13	1855/24	1855/26	-	-	-	124/13	727/36	726/22
Ø 14 x 14 mm	Plain - Liscio	1000 mm	-	-	-	727/18	-	727/20	-	-	-
		1200 mm	-	-	-	727/21	-	727/23	-	-	-
	Hammered - Spigolato	1000 mm	-	-	-	-	727/19	-	-	-	-
		1200 mm	-	-	-	-	727/22	-	-	-	-
Ø 14 mm	Plain - Liscio	1000 mm	1855/12	-	-	-	-	-	124/12	727/35	726/21
		1200 mm	1855/14	-	-	-	-	-	124/14	727/37	726/23
Ø 16 x 16 mm	Plain - Liscio	1000 mm	-	-	-	727/12	-	727/14	-	-	-
		1200 mm	-	-	-	727/15	-	727/17	-	-	-
	Hammered - Spigolato	1000 mm	-	-	-	-	727/13	-	-	-	-
		1200 mm	-	-	-	-	727/16	-	-	-	-
Ø 16 mm	Plain - Liscio	1000 mm	1855/17	-	-	-	-	-	-	-	-
		1200 mm	1855/18	-	-	-	-	-	-	-	-
Ø 18 mm	Plain - Liscio	1000 mm	1855/19	-	-	-	-	-	-	727/30	-
		1200 mm	1855/21	-	-	-	-	-	-	727/32	-
Ø 20 mm	Plain - Liscio	1000 mm	1855/20	-	-	-	-	-	-	727/31	-
		1200 mm	1855/22	-	-	-	-	-	-	727/33	-

**NEW**



Spear point  
Lancia  
Art. 126/A/2



Spear points are electrowelded to the picket: electrical energy is used to obtain the union between metal parts, the junction between the components is precise and clean.

Le lance sono elettrosaldate ai paletti: sfruttando l'energia elettrica, per ottenere l'unione tra parti metalliche, la giunzione tra i componenti risulta precisa e pulita.

Sec. - Sez.	Finish - Finitura	H	Art.
Ø 12 mm	Plain - Liscio	1000 mm	126/A/5
		1200 mm	126/A/6
	Bark effect-Corteccia	1000 mm	126/A/3
		1200 mm	126/A/4
Ø 14 mm	Plain - Liscio	1000 mm	126/A/9
		1200 mm	126/A/10
	Bark effect-Corteccia	1000 mm	126/A/7
		1200 mm	126/A/8



Picket section Sezione paletto	L1	L2	H
Ø 12 mm	Ø 18 mm	43 mm	100 mm
Ø 14 mm	Ø 18 mm	43 mm	100 mm



# TECHNICAL SUPPORT ASSISTENZA TECNICA

Our technicians are available for a specialist consultation, and can develop made to customized projects. With our Gonzato Contract division, we can also supply turnkey solutions, from engineering to installation.

I nostri tecnici sono a disposizione per consulenze specializzate e sono in grado di sviluppare progetti su misura. Con la nostra divisione Gonzato Contract possiamo fornire anche soluzioni chiavi in mano, dalla progettazione all'installazione.

**+39 0445 580 580**

from Monday to Friday  
dal Lunedì al Venerdì  
**08.00 -18.00 (GMT+1)**

**info@arteferro.com**

**www.arteferro.com**

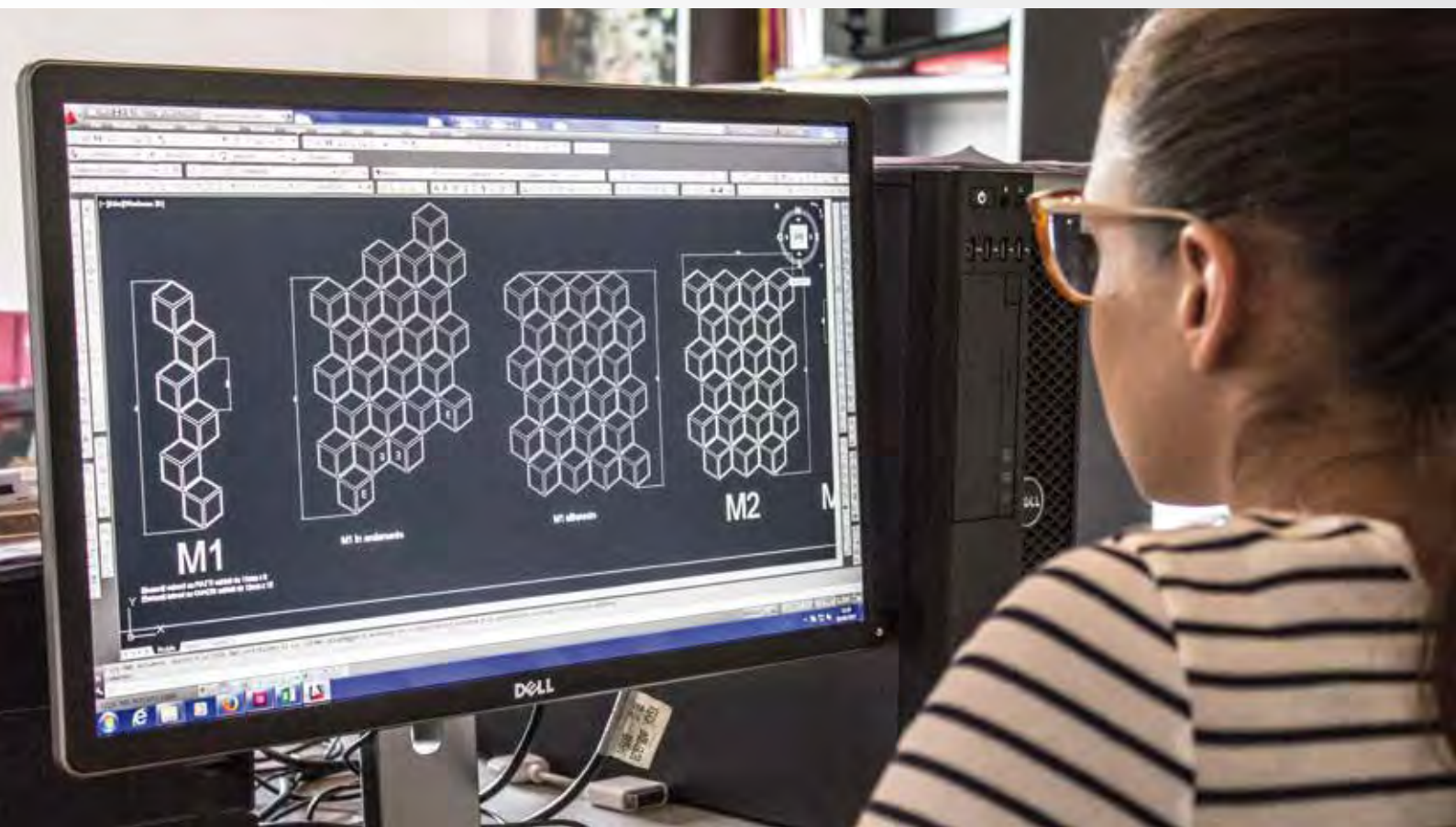



Arteferro spear points and tops reveal the nature of the buildings they protect. A historic symbol of protection for the most prestigious dwellings, you can embellish the pickets, posts and the columns of your fence. Designed to be positioned at the ends of the iron columns, these items reinforce and strengthen any wrought iron artefact.

Le lance ed i pomoli Arteferro rivelano la natura dell'edificio che proteggono. Simbolo storico di protezione delle dimore più prestigiose abbelliscono i paletti, i caposaldi e le colonne della tua recinzione. Ideati per essere posti alle estremità delle colonne in ferro, questi elementi conferiscono slancio e vigore ad ogni manufatto in ferro battuto.

# LANCE, POMOLI E TERMINALI COLONNA SPEAR POINT AND POST TOPS



8.

Spear points and Post tops - Lance Terminali e Pomoli

A	Spear points	A	Lance terminali .....	pag.174
B	Tops	B	Pomoli .....	pag.181
C	Post tops	C	Terminali a colonna .....	pag.183

HAND FORGED SPEAR POINTS  
LANCE FORGIATE A MANO



Art. 120/1  
Ø 40 mm  
H 220 mm



Art. 120/2  
Ø 35 mm  
H 200 mm



Art. 120/3  
Ø 30 mm  
H 170 mm



Art. 1854/7  
Ø 28 mm  
H 160 mm



Art. 1854/10  
Ø 30 mm  
H 180 mm



Art. 1854/8  
Ø 30 mm  
H 160 mm



Art. 1854/9  
Ø 32 mm  
H 180 mm



Art. 121/5  
Ø 25 x 25 mm  
H 160 mm



Art. 121/6  
Ø 30 x 30 mm  
H 186 mm



Art. 121/8  
Ø 30 x 30 mm  
H 153 mm



Art. 167/15  
Ø 30 x 30 mm  
H 62 mm



Art. 129/15  
Ø 32 mm  
H 140 mm



Art. 121/4  
Ø 33 mm  
H 130 mm



Art. 723/5  
Ø 28 mm  
H 160 mm

Art. 121/7  
Ø 40 x 40 mm  
H 186 mm

Art. 121/9  
Ø 40 x 40 mm  
H 153 mm

Art. 167/16  
Ø 40 x 40 mm  
H 68 mm



Art. 121/10  
Ø 50 x 50 mm  
H 290 mm

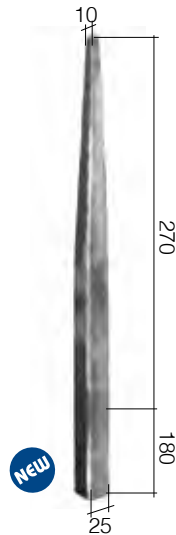

Art. 121/11  
Ø 25 x 25 mm  
H 450 mm





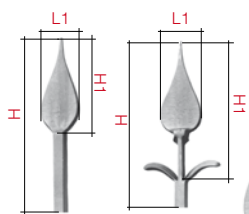

L1 x H1 x H  
Hot forged  
Fucinate a caldo



Sec- Sez.	Art.	Art.	Art.	Art.	Art.	Art.	Art.	Art.
∅ 12 x 12 mm	129/10 43 x 115 x 165 mm	722/5 43 x 132 x 150 mm	1764/73 35 x 75 x 150 mm	1764/43 35 x 85 x 150 mm	129/8 43 x 145 x 200 mm	722/3 43 x 132 x 200 mm	129/12 46 x 165 x 200 mm	722/1 46 x 180 x 200 mm
∅ 14 x 14 mm	129/9 50 x 128 x 180 mm	722/6 50 x 143 x 170 mm	1764/74 41 x 87 x 150 mm	1764/44 39 x 85 x 150 mm	129/7 50 x 156 x 200 mm	722/4 50 x 143 x 220 mm	129/11 52 x 185 x 230 mm	722/2 52 x 200 x 230 mm
∅ 16 x 16 mm	129/16 54 x 135 x 170 mm	722/7 53 x 145 x 210 mm	1764/75 46 x 95 x 150 mm	1764/45 46 x 105 x 150 mm	129/19 53 x 170 x 220 mm	128/D/9 53 x 170 x 240 mm	129/20 H 230 mm	722/8 H 240 mm
∅ 12 mm	1385/7 40 x 115 x 200 mm	1385/13 40 x 125 x 200 mm	1764/22 33 x 77 x 150 mm	1764/1 35 x 80 x 150 mm	1385/4 40 x 145 x 200 mm	1385/10 40 x 150 x 200 mm	-	-
∅ 14 mm	1385/8 45 x 125 x 200 mm	1385/14 45 x 140 x 200 mm	1764/23 38 x 86 x 150 mm	1764/2 37 x 85 x 150 mm	1385/5 45 x 145 x 200 mm	1385/11 45 x 163 x 200 mm	-	-
∅ 16 mm	1385/9 52 x 135 x 200 mm	1385/15 51 x 140 x 200 mm	1764/24 43 x 92 x 150 mm	1764/3 42 x 100 x 150 mm	1385/6 50 x 160 x 200 mm	1385/12 50 x 175 x 200 mm	-	-

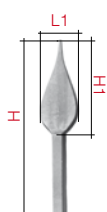

Hot forged  
Fucinate a caldo

hammered  
spigolato



Sec- Sez.	Art.	Art.	Art.	Art.	Art.	Art.	Art.
∅ 12 x 12 mm	1385/1 35 x 75 x 150 mm	-	-	-	-	129/4 34 x 140 x 180 mm	129/2 30 x 132 x 190 mm
∅ 14 x 14 mm	1385/2 40 x 90 x 150 mm	-	-	-	-	129/3 38 x 148 x 190 mm	129/1 40 x 147 x 200 mm
∅ 16 x 16 mm	1385/3 42 x 100 x 140 mm	-	-	-	-	-	-
∅ 20 x 20 mm	1385/16 51 x 125 x 250 mm	129/17 60 x 147 x 250 mm	-	-	-	-	-
∅ 30 x 30 mm	1385/17 80 x 200 x 300 mm	129/18 72 x 165 x 250 mm	-	-	-	-	-
∇ 20 x 6 mm	-	-	1765/4 32 x 90 x 200 mm	-	-	-	-
∇ 30 x 8 mm	-	-	-	1765/2 51 x 135 x 250 mm	1765/3 53 x 165 x 250 mm	-	-

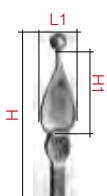

Cold stamped  
Stampate a freddo



Sec- Sez.	Art.	Art.	Art.
∅ 12 x 12 mm	1765/11 31 x 130 x 200 mm	1765/26 31 x 130 x 200 mm	1765/41 31 x 130 x 200 mm
∅ 14 x 14 mm	1765/16 37 x 130 x 200 mm	1765/31 37 x 130 x 200 mm	1765/46 37 x 130 x 200 mm
∅ 16 x 16 mm	1765/21 40 x 130 x 200 mm	1765/36 40 x 130 x 200 mm	1765/51 40 x 130 x 200 mm



Spear points - Lance terminali

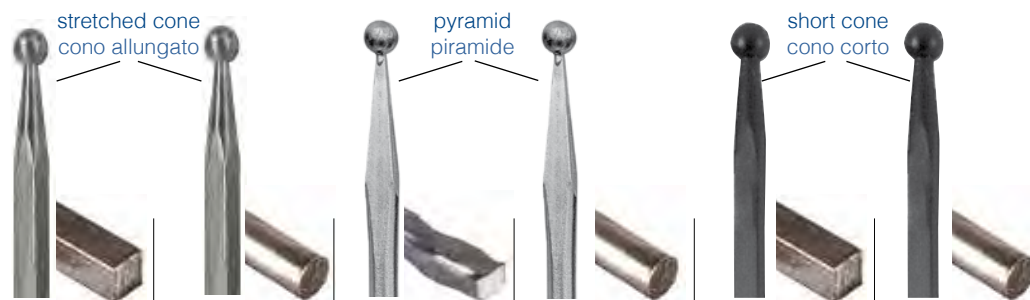

Section Sezione	Height Altezza	Art.	Art.	Art.	Art.	Art.	Art.
12 x 12 mm	200 mm	1759/45	-	1382/19	1382/13	118/C/63	118/C/66
	250 mm	-	-	-	-	-	-
14 x 14 mm	200 mm	1759/46	-	1382/20	1382/14	118/C/64	118/C/67
	250 mm	-	-	-	-	-	-
16 x 16 mm	200 mm	1759/47	-	-	-	118/C/65	118/C/68
	250 mm	-	-	-	-	-	-
25 x 25 mm	200 mm	1382/2	-	-	-	-	-
	250 mm	-	-	-	-	-	-
30 x 30 mm	200 mm	1382/3	-	-	-	-	-
	250 mm	-	1382/4	-	-	-	-
40 x 40 mm	200 mm	1382/1	-	-	-	-	-
	250 mm	-	1382/5	-	-	-	-

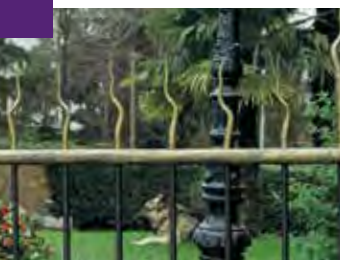

Section Sezione	Height Altezza	Art.	Art.	Art.	Art.	Art.
12 x 12 mm	250 mm	-	-	-	-	-
	300 mm	132/C/12	132/C/18	1381/1	1381/7	-
14 x 14 mm	250 mm	-	-	-	-	1380/2
	300 mm	132/C/13	132/C/19	1381/2	1381/8	-
16 x 16 mm	250 mm	-	-	-	-	-
	300 mm	132/C/13	132/C/20	1381/3	1381/9	-
20 x 20 mm	250 mm	-	-	-	-	1380/1
	300 mm	132/C/15	132/C/21	-	-	-

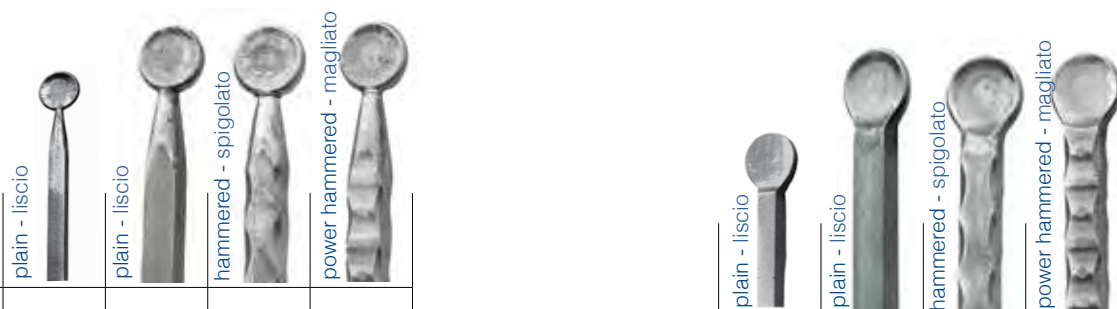

Section Sezione	Height Altezza	Art.	Art.	Art.	Art.
12 x 12 mm	200 mm	1754/45	-	-	-
14 x 14 mm	200 mm	1754/46	-	-	-
16 x 16 mm	200 mm	1754/47	-	-	-
25 x 25 mm	300 mm	-	1766/33	1766/35	1766/37
30 x 30 mm	300 mm	-	1766/34	1766/36	1766/38

Section Sezione	Height Altezza	Art.	Art.	Art.	Art.
12 x 12 mm	100 mm	129/6	-	-	-
14 x 14 mm	110 mm	129/5	-	-	-
25 x 25 mm	300 mm	-	1766/39	1766/41	1766/43
30 x 30 mm	300 mm	-	1766/40	1766/42	1766/44

## STAMPED SPEAR POINTS - LANCE STAMPATE

Spear points - Lance terminali



New



18

Art. 126/A/2

H 100 mm

L 43 mm

base Ø 18 mm

BEST PRICE



10.000.000

are the spear points that are shipped from our factories every year, and go on to adorn the most beautiful villas in the world

sono le lance che escono ogni anno dai nostri stabilimenti e vanno ad ornare le più belle ville del mondo



Not all of the Arteferro items are available in **Arteferro Quick**, just a special selection. Find out about the entire range in the catalogue

In **Arteferro Quick** non sono presenti tutti gli articoli Arteferro, ma solo una speciale selezione. Scopri la gamma completa nel catalogo

*Compendium*





Art. 726/4  
Ø 24 mm  
H 125 mm  
Art. 126/9  
Ø 20 mm  
H 90 mm



Art. 726/3  
Ø 30 mm  
H 180 mm



Art. 126/6  
Ø 34 mm  
H 190 mm  
Art. 126/19  
Ø 25 mm  
H 140 mm  
Art. 126/20  
Ø 30 mm  
H 160 mm



Art. 122/A/1  
Ø 35 mm  
H 200 mm

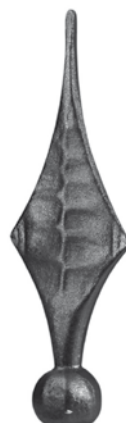

Art. 1855/10  
Ø 30 mm  
H 170 mm



Art. 1855/9  
Ø 35 mm  
H 200 mm

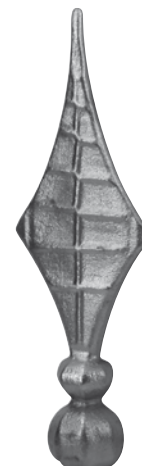

Art. 1855/8  
Ø 40 mm  
H 220 mm



Art. 125/1  
Ø 35 mm  
H 125 mm



Art. 125/2  
Ø 14 x 14 mm  
H 135 mm



Art. 1386/12  
Ø 32 mm  
60 x 125 mm  
Art. 1386/13  
Ø 25 mm  
55 x 110 mm



Art. 727/1  
Ø 32 mm  
70 x 140 mm  
Art. 727/2  
Ø 30 mm  
65 x 125 mm  
Art. 727/3  
Ø 25 mm  
55 x 110 mm



Art. 1386/11  
Ø 16 mm  
650 x 150 mm



Art. 124/6  
Ø 15 mm  
H 155 mm



Art. 725/1  
Ø 30 mm  
H 165 mm



Art. 727/6  
Ø 24 mm  
60 x 160 mm  
Art. 727/5  
Ø 27 mm  
70 x 185 mm  
Art. 727/4  
Ø 30 mm  
80 x 210 mm



Art. 127/1  
Ø 10 x 10 mm  
H 70 mm  
Art. 127/2  
Ø 12 x 12 mm  
H 70 mm

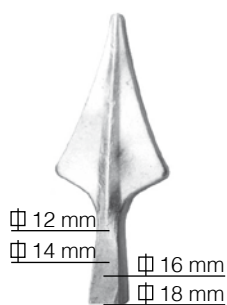

Ø 12 mm  
Ø 14 mm  
Ø 16 mm  
Ø 18 mm

Art. 126/D/1  
Ø 18 x 18 mm  
60 x 155 mm



Art. 123/6  
Ø 35 mm  
H 180 mm



Art. 726/1  
Ø 12 x 12 mm  
H 185 mm



Art. 726/2  
Ø 12 x 12 mm  
H 165 mm



Art. 1386/6  
Ø 12 x 12 mm  
H 120 mm  
Art. 1386/5  
Ø 14 x 14 mm  
H 140 mm

## STAMPED SPEAR POINTS - LANCE STAMPATE

## Spear points - Lance terminali



Art. 1386/10  
Ø 21,5 mm  
60 x 115 mm



Art. 126/8  
Ø 20 mm  
H 112 mm  
Art. 126/21  
Ø 25 mm  
H 135 mm



Art. 1855/5  
Ø 12 mm  
60 x 135 mm



Art. 1855/4  
Ø 12 mm  
60 x 135 mm



Art. 726/6  
Ø 22 mm  
H 120 mm  
Art. 726/7  
Ø 26 mm  
H 135 mm



Art. 1855/1  
Ø 24 mm  
65 x 128 mm  
Art. 1855/2  
Ø 25 mm  
70 x 140 mm  
Art. 1855/3  
Ø 32 mm  
86 x 170 mm



Art. 1386/7  
Ø 16 mm  
70 x 155 mm  
Art. 1386/8  
Ø 12 mm  
60 x 130 mm



Art. 124/1  
Ø 12 mm  
H 125 mm  
Art. 124/2  
Ø 15 mm  
H 160 mm  
Art. 124/9  
Ø 20 mm  
H 190 mm



Art. 124/7  
Ø 14 mm  
H 127 mm



Art. 124/3  
Ø 12 mm  
H 125 mm  
Art. 124/4  
Ø 15 mm  
H 160 mm  
Art. 124/5  
Ø 16,5 mm  
H 190 mm



Art. 126/B/1  
Ø 19 mm  
82 x 195 mm  
Art. 126/B/2  
Ø 16 mm  
68 x 160 mm  
Art. 126/B/3  
Ø 13 mm  
54 x 130 mm



Art. 124/8  
Ø 15 mm  
72 x 215 mm



Art. 126/13  
Ø 16 mm  
64 x 170 mm  
Art. 126/14  
Ø 16 mm  
55 x 140 mm



Art. 126/B/6  
Ø 20 mm  
45 x 80 mm  
Art. 126/B/7  
Ø 25 mm  
64 x 125 mm  
Art. 126/B/8  
Ø 38 mm  
80 x 140 mm



Art. 1387/1  
Ø 23 x 23 mm  
H 75 mm  
Art. 1387/2  
Ø 27 x 27 mm  
H 100 mm



Art. 1387/3  
Ø 20 x 20 mm  
H 133 mm



Art. 727/7  
Ø 40 x 40 mm  
120 x 200 mm  
Art. 727/8  
Ø 32 x 32 mm  
90 x 160 mm  
Art. 727/9  
Ø 25 x 25 mm  
70 x 120 mm





Art. 726/12  
Ø 18 mm  
H 110 mm



Art. 726/10  
H 100 mm  
base Ø 12 mm  
Art. 726/11  
H 125 mm  
base Ø 15 mm



Art. 126/E/1  
Ø 15 mm  
55 x 150 mm



Art. 126/A/1  
Ø 15 mm  
68 x 150 mm



Art. 126/B/9  
Ø 22 mm  
66 x 165 mm



Art. 726/9  
Ø 35 mm  
H 190 mm



Art. 725/2  
Ø 32 mm  
H 225 mm



Art. 724/1  
Ø 35 mm  
H 295 mm



Art. 126/18  
Ø 40 x 40 mm  
H 150 mm



Art. 123/5  
Ø 25 x 25 mm  
H 160 mm



Art. 123/3  
Ø 32 mm  
H 130 mm



Art. 1386/2  
Ø 32 x 32 mm  
H 135 mm



Art. 1386/1  
Ø 40 x 40 mm  
H 150 mm  
Art. 1386/2  
Ø 32 x 32 mm  
H 135 mm  
Art. 1386/3  
Ø 25 x 25 mm  
H 125 mm  
Art. 1386/4  
Ø 20 x 20 mm  
H 100 mm



Art. 126/2  
Ø 20 x 20 mm  
H 130 mm  
Art. 126/15  
Ø 30 x 30 mm  
H 160 mm  
Art. 126/16  
Ø 40 x 40 mm  
H 190 mm



Art. 126/1  
Ø 10 x 10 mm  
H 140 mm



Art. 727/10  
Ø 33 mm  
40 x 150 mm  
Art. 727/11  
Ø 30 mm  
35 x 120 mm



Art. 126/C/7  
Ø 18 mm  
H 125 mm  
Art. 126/C/8  
Ø 12 x 12 mm  
H 100 mm

## STAMPED TOPS - POMOLI STAMPATI

Tops - Pomoli

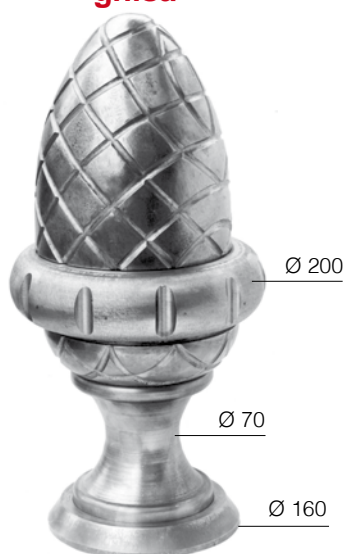
cast iron  
ghisa

Art. 128/C/2  
base Ø 160 mm  
H 405 mm



Art. 749/8  
base Ø 42 mm  
H 85 mm  
Art. 749/9  
base Ø 55 mm  
H 120 mm  
Art. 749/10  
base Ø 70 mm  
H 150 mm



Art.	Sphere diam. sfera	Diam. base diam.	H
1404/1	110 mm	90 mm	140 mm
1404/2	90 mm	70 mm	125 mm
1404/3	70 mm	55 mm	100 mm
1404/4	55 mm	45 mm	85 mm



Art.	Sphere diam. sfera	Diam. base diam.	H
1404/5	95 mm	100 x 100 mm	150 mm
1404/6	85 mm	80 x 80 mm	120 mm
1404/7	70 mm	60 x 60 mm	105 mm
1404/8	50 mm	40 x 40 mm	75 mm
1404/9	30 mm	25 x 25 mm	45 mm



Art. 749/13  
base Ø 43 mm  
H 85 mm  
Art. 749/14  
Base Ø 49 mm  
H 125 mm



Art. 749/18  
base  $\Phi$  40 x 40 mm  
H 85 mm  
Art. 749/19  
base  $\Phi$  60 x 60 mm  
H 125 mm



Art.	Sphere diam. sfera	Diam. base diam.	H
128/31	-	100 mm	180 mm
128/35	-	50 mm	90 mm

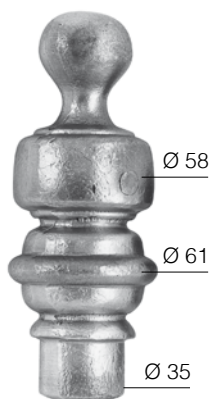

Art. 749/1  
base Ø 35 mm  
H 155 mm



Art. 749/2  
base Ø 22 mm  
H 95 mm



FORGED TOPS - POMOLI FORGIATI



Art. 749/22  
 Ø 70 mm  
 base Ø 51 mm



Art. 116/A/20  
 sfera Ø 55 mm  
 base Ø 38 mm



Art. 116/A/21  
 sfera Ø 40 mm  
 base Ø 26 mm



Art. 116/A/22  
 sfera Ø 30 mm  
 base Ø 22 mm

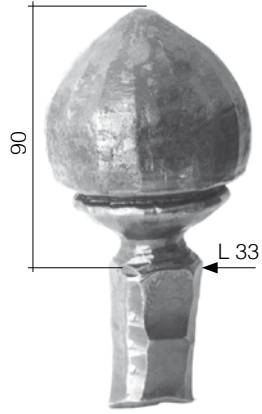

Art. 113/9  
 Ø 75 mm



Art. 113/10  
 Ø 70 mm

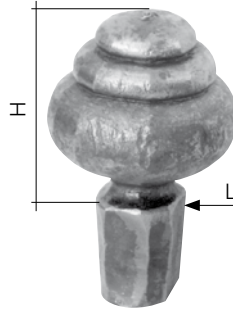

Art. 116/A/17  
 Ø 72 mm  
 L 40 x H 75 mm  
 Art. 116/A/19  
 Ø 55 mm  
 L 30 x H 65 mm

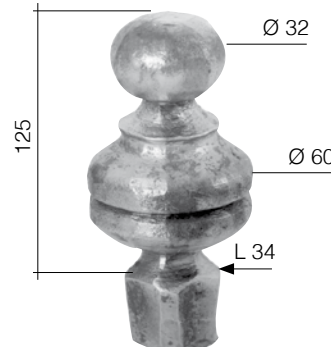

Art. 116/A/18  
 Ø 60 mm

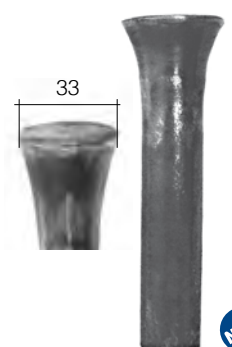

Art. 595/7/S  
 Ø 20 mm  
 H 150 mm

NEW

WELDED TOPS - POMOLI SALDATI



Art. 1400/2  
 H 130 mm  
 base Ø 30 mm  
 Ø 120 mm



Art. 1400/1  
 H 100 mm  
 base Ø 25 mm  
 Ø 160 mm



Art. 1398/1  
 H 75 mm  
 Ø 120 mm

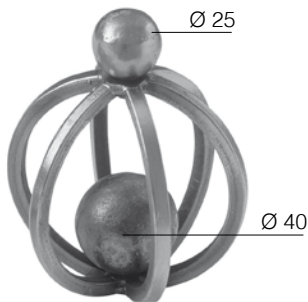

Art. 1398/2  
 Ø 6 x 6 mm  
 H 115 mm  
 Ø 90 mm



Art. 1399/1  
 H 140 mm  
 base Ø 25 mm  
 Ø 115 mm







Hollow sphere  
Sfera vuota  
Art. 1165/6

for tube - per tubo  
Ø 30 x 30 mm  
Ø 40 mm  
Art. 1165/5  
for tube - per tubo  
Ø 40 x 40 mm  
Ø 50 mm



Entirely welded sheet metal  
Lamiera saldata interamente

Art. 1858/1

for tube - per tubo  
Ø 50 x 50 mm  
H 70 mm

Art. 1858/2

for tube - per tubo  
Ø 60 x 60 mm  
H 84 mm

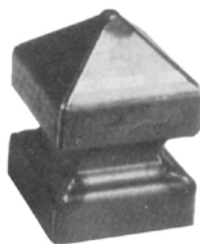

Steel sheet  
Lamiera puntata  
Art. 167/11

for tube - per tubo  
Ø 80 x 80 mm  
H 115 mm

Art. 167/14

for tube - per tubo  
Ø 150 x 150 mm  
H 192 mm



Hand forged  
Forgiato a mano

Art. 167/15  
Ø 30 x 30 mm  
H 62 mm

Art. 167/16  
Ø 40 x 40 mm  
H 68 mm

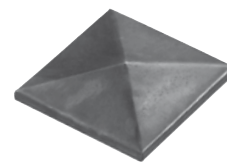

Art. 167/3

for tube - per tubo  
Ø 30 x 30 mm

Art. 167/4

for tube - per tubo  
Ø 40 x 40 mm

Art. 167/6

for tube - per tubo  
Ø 60 x 60 mm

Art. 167/8

for tube - per tubo  
Ø 100 x 100 mm



Hand forged  
Forgiato a mano

Art. 178/35

Ø 40 mm  
plain - liscio  
120 x 300 mm

Art. 178/36

Ø 30 mm  
120 x 300 mm  
plain - liscio



Hand forged  
Forgiato a mano

Art. 593/3/S1

Ø 40 mm  
spigolato - spigolato  
130 x 350 mm

Art. 593/3/S4

Ø 40 mm  
plain - liscio  
130 x 350 mm



BEST PRICE

Art. 593/10

Ø 50 x 6 mm  
plain - liscio  
70 x 300 mm

Art. 593/11

Ø 60 x 6 mm  
plain - liscio  
70 x 300 mm



NEW

Art. 6112/4/S

Ø 25 mm  
L 150 x 250 mm



NEW

Art. 596/4/S3

Ø 25 mm  
L 150 x H 300 mm



plain

liscio

Art. 178/20

Ø 30 x 30 mm  
H 300 mm

Art. 178/29

Ø 40 x 40 mm  
H 300 mm



power  
hammered

magliato

Art. 178/24

Ø 30 x 30 mm  
H 300 mm

Art. 178/31

Ø 40 x 40 mm  
H 300 mm



hammered

spigolato

Art. 178/22

Ø 30 x 30 mm  
H 300 mm

Art. 178/30

Ø 40 x 40 mm  
H 300 mm

# GONZATO

C O N T R A C T

## We forge your dreams

Gonzato Contract is a division of Ind.i.a. that deals with special supplies in wrought iron, stainless steel or any other metal, for prestigious private homes, public buildings, hotels, community centres and for all types of commissions that demand a custom made approach, from design to installation.

Mission: to meet the needs of designers, contractors and private individuals who are looking for a single supplier who can provide them with high quality metal products and a high level of service.

Gonzato Contract si occupa di forniture speciali, in ferro battuto, in acciaio inox o in qualsiasi altro metallo, per prestigiose proprietà private, edifici pubblici, alberghi, spazi comunitari e per ogni tipo di commissione che richieda un approccio custom made, dalla progettazione all'installazione.

Mission: rispondere alle esigenze di progettisti, contractors e privati alla ricerca di un unico interlocutore che fornisca loro prodotti in metallo di elevata qualità e un servizio di alto livello.



[www.gonzatocontract.com](http://www.gonzatocontract.com)



GONZATO GROUP

Gonzato Contract is a division of Ind.i.a. spa (Gonzato Group)  
Via Vicenza, 6/14 (SP46) – 36034 Malo (Vicenza) Italy  
Tel. +39 0445 580 580 • Fax +39 0445 580 874  
[info@gonzatocontract.com](mailto:info@gonzatocontract.com) • [www.gonzatocontract.com](http://www.gonzatocontract.com)

 **ind.i.a.**





Arteferro rosaces are particularly elaborate decorative elements that can be used to embellish external and internal environments like gates and grilles, balustrades, stairs, walls and skylights too.

I rosoni Arteferro sono elementi decorativi particolarmente elaborati che possono essere impiegato per abbellire ambienti esterni ed interni come cancelli ed inferriate ma anche parapetti, scale, pareti e lucernari.













ROSACES

ROSONI

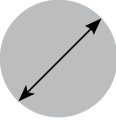











The rosaces have been listed by diameter: after identifying this dimension, it is enough to choose the section and then the art type

I rosioni sono stati catalogati per diametro: identificata tale dimensione, basterà scegliere la sezione e quindi la tipologia artistica.

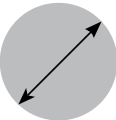











from-da Ø 112 mm to-a Ø 250 mm

	plain liscio	notched tacchettato	notched tacchettato	notched tacchettato	notched tacchettato	notched tacchettato
						
	stamped stampato	without collars senza fascette	without collars senza fascette	without collars senza fascette	without collars senza fascette	without collars senza fascette
						
Section-Sezione	Ø 112 mm	Ø 153 mm	Ø 160 mm	Ø 225 mm	Ø 250 mm	Ø 250 mm
	Art.	Art.	Art.	Art.	Art.	Art.
Φ 6 x 6 mm	-	30/4	-	-	-	-
Φ 8 x 8 mm	-	-	-	22/A/2	20/5	20/6
Φ 14 x 14 mm	1393/2	-	-	-	-	-
∇ 10 x 5 mm	-	-	30/7	-	-	-

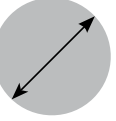
Ø 250 mm

	notched tacchettato	notched tacchettato	notched tacchettato	notched tacchettato	notched tacchettato	notched tacchettato
						
	with collars con fascette	without collars senza fascette	without collars senza fascette	without collars senza fascette	without collars senza fascette	without collars senza fascette
						
Section-Sezione	Ø 250 mm	Ø 250 mm	Ø 250 mm	Ø 250 mm	Ø 250 mm	Ø 250 mm
	Art.	Art.	Art.	Art.	Art.	Art.
Φ 6 x 6 mm	-	-	-	-	-	-
Φ 8 x 8 mm	-	-	-	18/A/1	18/1	18/2
∇ 10 x 5 mm	23/1	-	-	-	-	-
∇ 20 x 4 mm	-	23/3	23/2	-	-	-

from-da Ø 250 mm to-a Ø 260 mm

	notched tacchettato	notched tacchettato	notched tacchettato	plain liscio	plain liscio	notched tacchettato
						
	without collars senza fascette	without collars senza fascette	without collars senza fascette	without collars senza fascette	without collars senza fascette	without collars senza fascette
						
Section-Sezione	Ø 250 mm	Ø 250 mm	Ø 250 mm	Ø 250 mm	250 x 250 mm	Ø 260 mm
	Art.	Art.	Art.	Art.	Art.	Art.
Φ 8 x 8 mm	17/1	17/2	16/3	21/4	-	-
∇ 10 x 5 mm	-	-	-	-	-	-
∇ 12 x 6 mm	-	-	-	-	33/2	-
∇ 16 x 4 mm	-	-	-	-	33/3	-
Ø 8 mm	-	-	-	-	-	26/2
Ø 10 mm	-	-	-	-	-	26/1

from-da Ø 260 mm  
to-a Ø 290 mm











	plain liscio with collars con fascette	plain liscio without collars senza fascette	plain liscio with collars con fascette	plain liscio with collars con fascette	plain liscio with collars con fascette	plain liscio with collars con fascette
Section-Sezione	Ø 260 mm	Ø 260 mm	Ø 270 mm	Ø 270 mm	Ø 275 mm	Ø 290 mm
Art.	Art.	Art.	Art.	Art.	Art.	Art.
Ø 8 x 8 mm	16/1	16/2	-	-	-	-
Ø 12 x 12 mm	-	-	1014/1	-	-	-
Ø 10 x 5 mm	-	-	-	-	-	22/3
Ø 14 x 8 mm	-	-	-	-	21/5	-
Ø 12 mm	-	-	1014/2	1014/3	-	-

from-da Ø 295 mm  
to-a Ø 380 mm



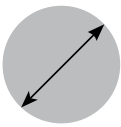

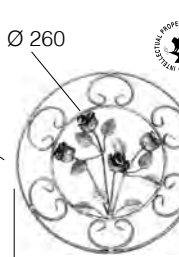

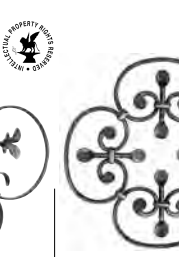
	plain liscio Rosettes 116/A/4 on both sides Rosette 116/A/4 sui 2 lati	notched tacchettato with collars con fascette	notched tacchettato without collars senza fascette	plain liscio with collars con fascette	plain liscio
Section-Sezione	Ø 295 mm	Ø 300 mm	Ø 300 mm	320 x 320 mm	Ø 380 mm
Art.	Art.	Art.	Art.	Art.	Art.
Ø 8 x 8 mm	-	18/3	18/4	-	-
Ø 12 x 12 mm	1013/2	-	-	-	-
Ø 10 x 5 mm	-	-	-	-	24/C/2
Ø 12 x 6 mm	-	-	-	GD270/2	-
Ø 12 mm	<b>1013/1</b>	-	-	-	-







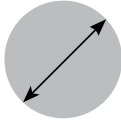

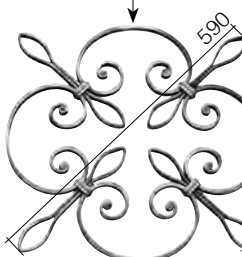
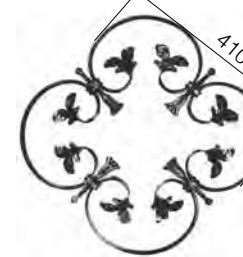
from-da Ø 360 mm  
to-a Ø 380 mm

	plain liscio without collars senza fascette	plain liscio without collars senza fascette	notched tacchettato without collars senza fascette	notched tacchettato with collars con fascette	notched tacchettato with collars con fascette
Section-Sezione	Ø 360 mm	Ø 370 mm	Ø 380 mm	Ø 380 mm	Ø 380 mm
Art.	Art.	Art.	Art.	Art.	Art.
Ø 8 x 8 mm	-	-	-	-	-
Ø 12 x 12 mm	-	-	-	-	-
Ø 10 x 5 mm	-	-	454/3	24/1	24/2
Ø 12 x 6 mm	1009/1	1009/2	-	-	-
Ø 12 mm	-	-	-	-	-

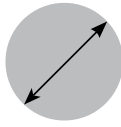

	plain liscio	plain liscio	diamond diamantato	plain liscio	plain liscio	plain liscio
						
	190		Ø 260			
from-da Ø 325 mm to-a Ø 440 mm						
Section-Sezione	Ø 325 mm	Ø 395 mm	Ø 415 mm	Ø 420 mm	Ø 440 mm	Ø 440 mm
	Art.	Art.	Art.	Art.	Art.	Art.
Ø 12 x 12 mm	-	GD211/2	-	-	-	-
Ø 14 x 14 mm	-	-	-	-	-	1659/1
Ø 12 x 6 mm	-	-	720/2	450/1	-	-
Ø 14 x 8 mm	GD187/2	-	-	-	-	-
Ø 10 mm	-	-	-	-	1011/1	-

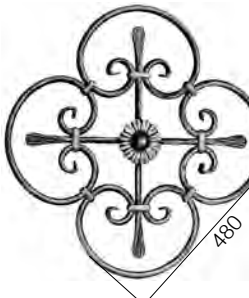
Rosettes 116/A/3 on both sides  
Rosette 116/A/3 sui 2 lati

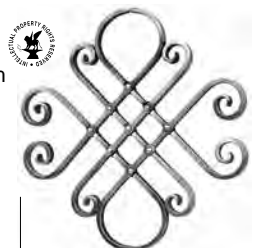

	plain liscio	plain liscio	plain liscio	plain liscio
				
		455		470
from-da Ø 450 mm to-a Ø 470 mm				
Section-Sezione	Ø 450 mm	Ø 455 mm	Ø 460 mm	Ø 470 mm
	Art.	Art.	Art.	Art.
Ø 12 x 6 mm	-	-	24/B/1	-
Ø 14 x 8 mm	-	1667/1	-	1667/2
Ø 12 mm	455/2	-	-	-

	plain liscio	plain liscio	martellato hammered	plain liscio
				
inner circle cerchio interno Ø 450 mm				
from-da Ø 500 mm to-a Ø 610 mm				
Section-Sezione	Ø 500 mm	Ø 565 mm	Ø 600 mm	Ø 610 mm
	Art.	Art.	Art.	Art.
Ø 12 x 12 mm	-	-	24/3	-
Ø 14 x 14 mm	-	-	-	452/1
Ø 14 x 8 mm	GD268/1	-	-	-
Ø 14 mm	-	446/4	-	-

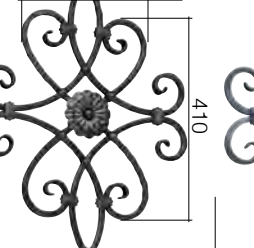
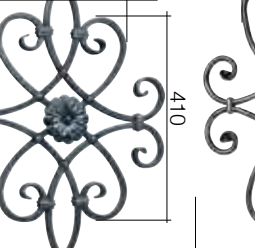
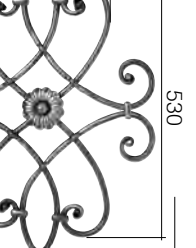
Rosettes 116/A/3 on both sides  
Rosette 116/A/3 sui 2 lati

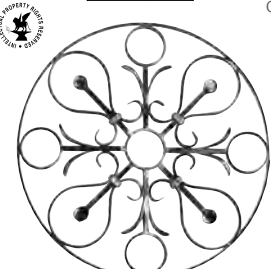
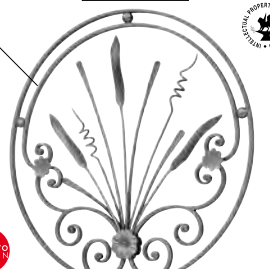
	plain liscio	plain liscio	hammered spigolato	plain liscio	plain liscio
from-da L 400 mm to-a L 610 mm					
Section-Sezione	L 410 x H 400 mm	L 400 x H 575 mm	L 430 x H 530 mm	L 430 x H 530 mm	L 475 x H 610 mm
	Art.	Art.	Art.	Art.	Art.
∅ 12 x 12 mm	-	-	26/C/1	1641/2	-
∅ 14 x 14 mm	-	-	1641/6	1641/5	-
∅ 16 x 8 mm	1657/1	1657/4	-	-	-
∅ 14 mm	-	-	-	-	1641/1

	power hammered magliato	plain liscio	plain liscio
from-da ∅ 610 mm to-a ∅ 620 mm			
Section-Sezione	∅ 610 mm	∅ 615 mm	∅ 620 mm
	Art.	Art.	Art.
∅ 14 x 14 mm	459/1	-	-
∅ 12 x 6 mm	-	1024/1	-
∅ 14 x 8 mm	-	-	GD268/2

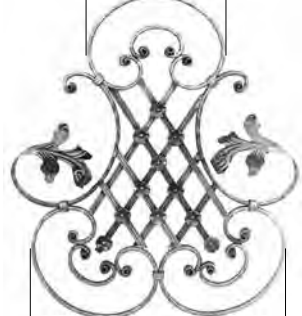
	hammered spigolato	hammered spigolato	hammered spigolato
from-da L 515 mm to-a L 710 mm			
Section-Sezione	L 515 x H 670 mm	L 515 x H 690 mm	L 640 x H 710 mm
	Art.	Art.	Art.
∅ 14 x 14 mm	720/1	719/1	-
∅ 16 x 8 mm	-	-	719/2
∅ 14 mm	-	-	-

plain  
liscio



plain  
liscio



plain  
liscio



from-da Ø 470 mm  
to-a Ø 840 mm

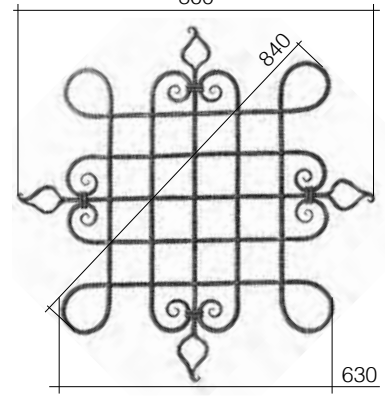
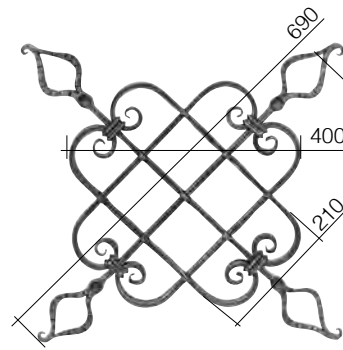
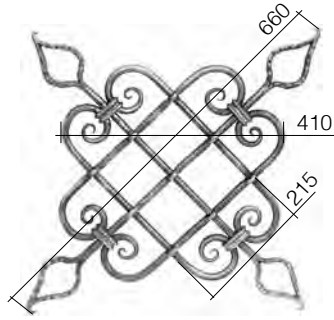
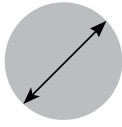

Section-Sezione	Ø 660 mm	Ø 690 mm	Ø 840 mm
	Art.	Art.	Art.
⊘ 16 x 8 mm	-	680/1	-
Ø 12 mm	679/1	-	679/2
Ø 14 mm	-	-	-

plain  
liscio



plain  
liscio



plain  
liscio



plain  
liscio



hammered  
spigolato



NEW

CONTEAR

ARTEFERRO

from-da Ø 600 mm  
to-a Ø 910 mm

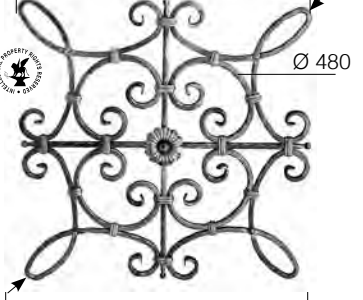
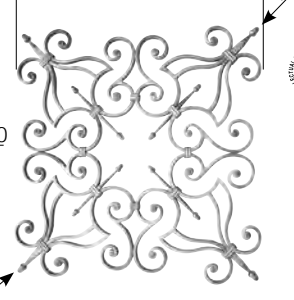
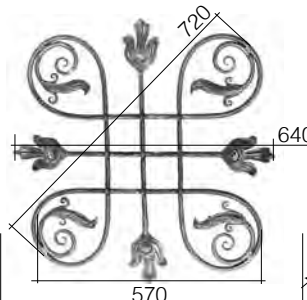
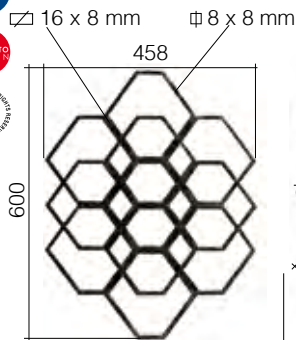
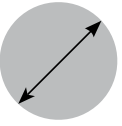

Section-Sezione	Ø 600 mm	Ø 720 mm	Ø 770 mm	Ø 920 mm
	Art.	Art.	Art.	Art.
⊘ 8 x 8 mm	GD299/4	-	-	-
⊘ 12 x 12 mm	-	-	-	480/1
⊘ 14 x 8 mm	-	-	GD151/2	-
Ø 12 mm	-	679/3	-	-

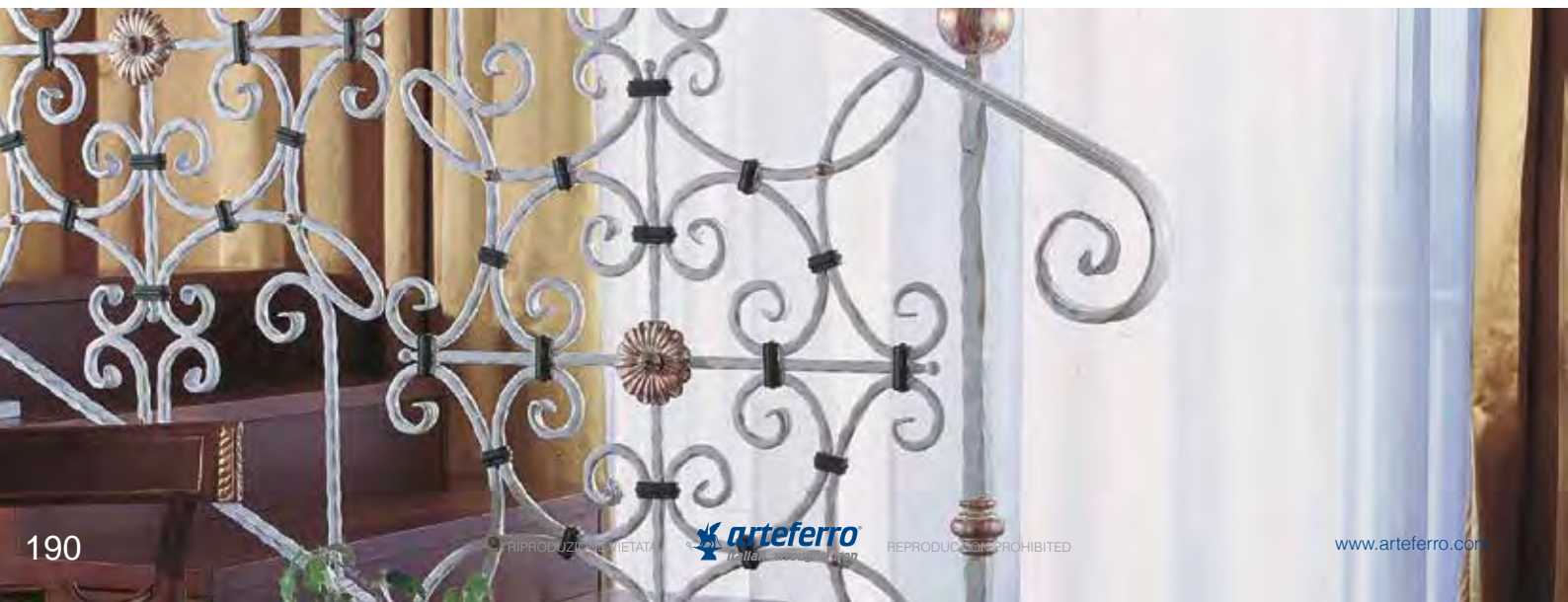





In 1972  
the first rosace  
was sold as item no. 31,  
today on sale as  
art.no.18/2

Nel 1972  
fu venduto  
il primo rosone  
art. 31 oggi in vendita  
come art. 18/2



**EXTENSIBLE ROSACES**  
"ARTICULATED"  
**ROSONI ESTENSIBILI**  
"SNODATI"

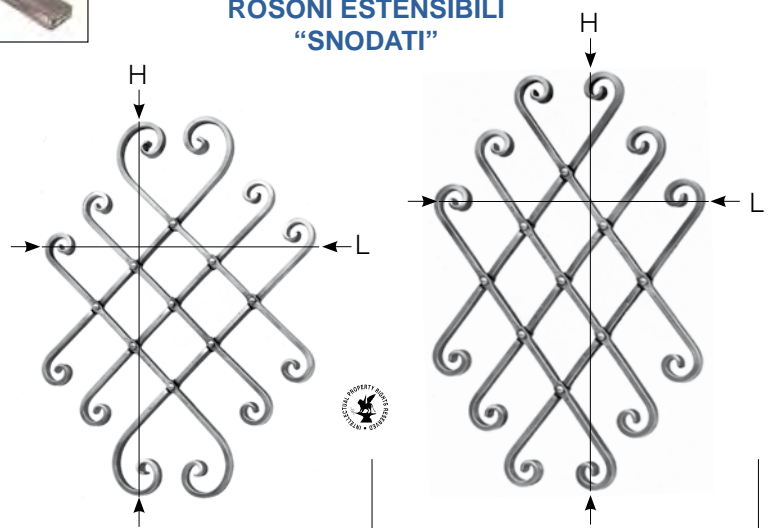

Section-Sezione	from-da L. 440 x H. 580 mm to-a L. 380 x H. 620 mm	from-da L. 440 x H. 490 mm to-a L. 360 x H. 550 mm
	Art.	Art.
∅ 16 x 8 mm	* 1658/1	* 1658/2

\*articles not saleable in Spain  
\*articoli non vendibili in Spagna

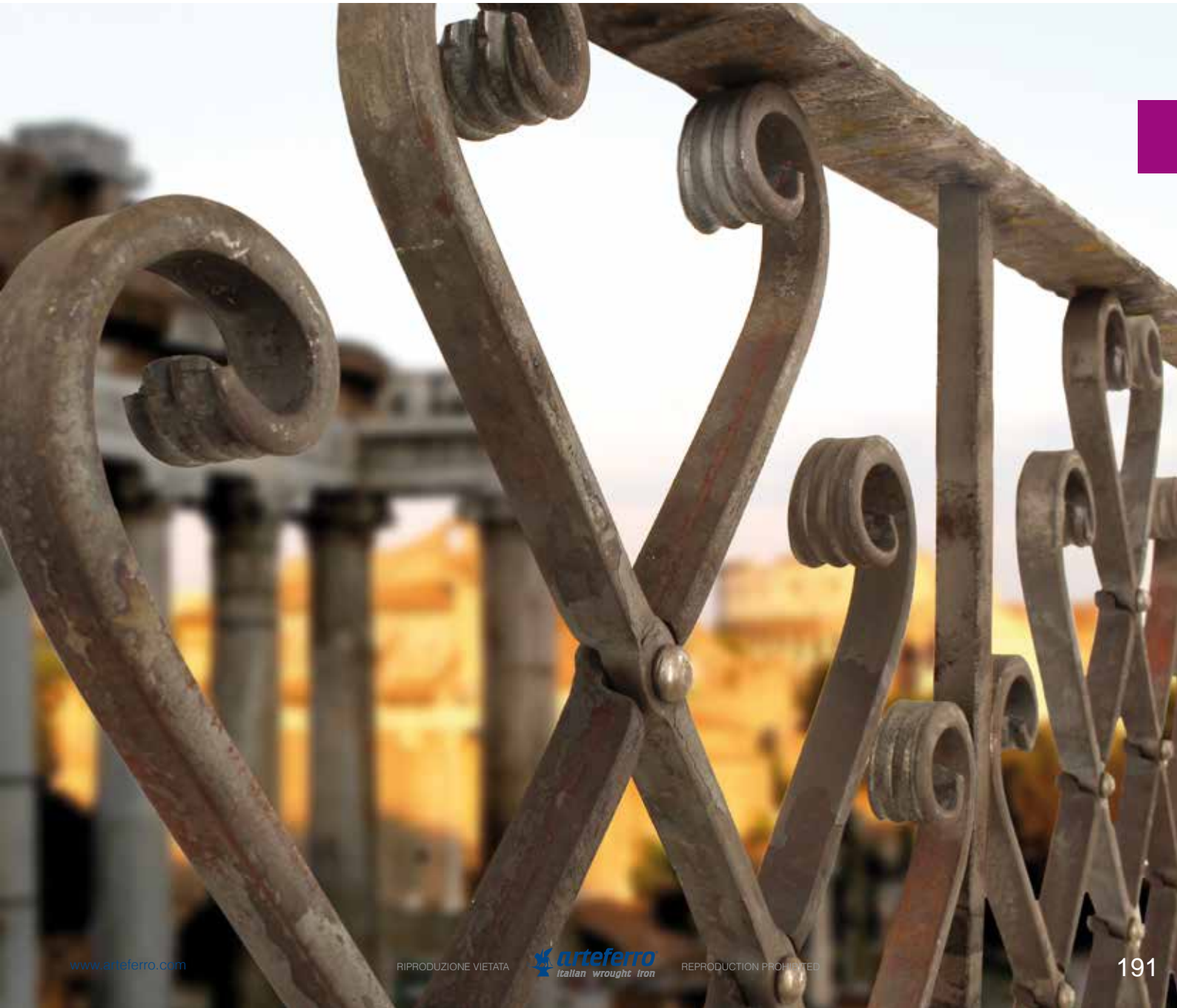



# LOGISTIC SUPPORT ASSISTENZA LOGISTICA

With branches spread across the continents, we have the largest stock of articles in the branch worldwide, and, thanks to our agreements with major carriers, we can guarantee prompt deliveries in any country.

Con le nostre filiali sparse in tutti i continenti, disponiamo del più grande stock mondiale di articoli del settore e, grazie ai nostri accordi con i più importanti spedizionieri, possiamo garantire consegne celeri in qualsiasi paese.

**+39 0445 580 580**

from Monday to Friday  
dal Lunedì al Venerdì  
08.00 -18.00 (GMT+1)

**info@arteferro.com**

**www.arteferro.com**





RINGS

Arteferro circles, with their simple, discreet shape, are items that can complete any wrought iron composition. Since they can be used as decorations and joints, they even help to support items of great structural complexity. They are available with various types of section: rounded, half rounded, square with hot pressed ends and various types of finishes.

I cerchi Arteferro, con la loro forma semplice e discreta, sono elementi in grado di completare qualsiasi composizione in ferro battuto. Utilizzabili come decoro e congiunzione, aiutano a sostenere i manufatti anche di grande complessità strutturale. Sono disponibili in varie sezioni: tondo, mezzo tondo, quadre con estremità stampate a caldo e lavorazioni di vario tipo.

CERCHI



Arteferro products  
can be manufactured  
as well as customised.

I prodotti Arteferro  
sono realizzabili  
anche su misura.

### PLAIN RINGS CERCHI LISCI



Section Sezione	Ø 10 mm	Ø 12 mm	Ø 14 mm	Ø 16 mm	Φ 12 x 12 mm	Φ 14 x 14 mm	Φ 16 x 16 mm	Φ 18 x 18 mm	Φ 20 x 20 mm	Φ 25 x 25 mm	Φ 30 x 30 mm
	Art.	Art.	Art.	Art.	Art.	Art.	Art.	Art.	Art.	Art.	Art.
Ø 89 mm	-	-	-	-	491/8/D89	-	-	-	-	-	-
Ø 100 mm	1317/6	1317/9	1803/4	-	491/8	491/16	491/17	-	-	-	-
Ø 105 mm	-	1317/28	-	-	1802/64	1802/65	1802/114	-	-	-	-
Ø 110 mm	-	1317/27	1803/7	-	1802/68	1802/69	1802/70	-	-	-	-
Ø 115 mm	1317/7	1317/10	1803/5	-	1317/1	1802/73	1802/74	-	-	-	-
Ø 120 mm	1317/24	1317/25	-	-	1802/77	1802/78	1802/79	-	-	-	-
Ø 127 mm	-	-	-	-	491/8/D127	-	-	-	-	-	-
Ø 130 mm	1317/8	1317/11	1803/6	-	1317/2	1802/82	1802/83	1802/84	1802/85	-	-
Ø 133 mm	-	-	-	-	491/8/D133	-	-	-	-	-	-
Ø 135 mm	-	-	-	1803/8	-	-	1802/115	-	-	-	-
Ø 140 mm	-	-	-	-	491/8/D140	-	-	-	-	-	-
Ø 160 mm	-	-	-	-	1802/88	1802/89	1802/90	1802/91	1802/92	1802/93	-
Ø 180 mm	-	-	-	-	1802/96	1802/97	1802/98	1802/99	1802/100	1802/101	1802/102
Ø 190 mm	-	-	-	-	-	-	-	-	-	-	-
Ø 200 mm	-	-	-	-	1802/105	1802/106	1802/107	1802/108	1802/109	1802/110	1802/111

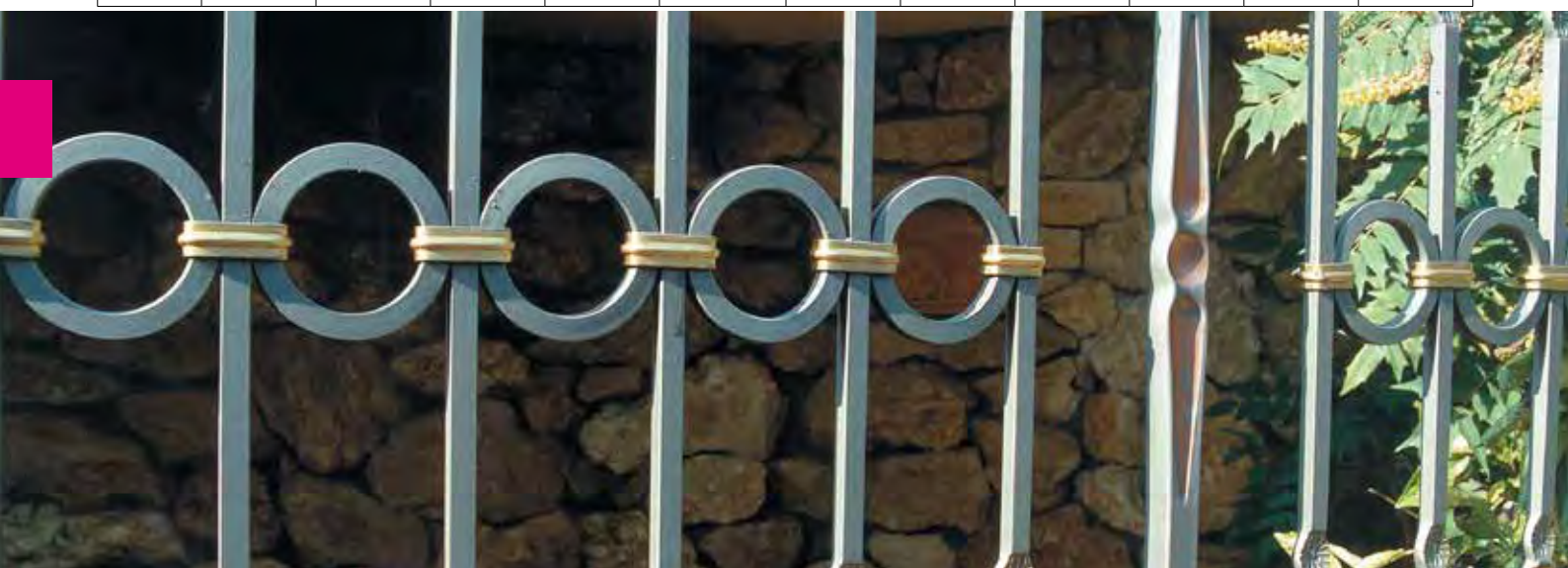

Section Sezione	12 x 6 mm	14 x 6 mm	14 x 8 mm	16 x 4 mm	16 x 6 mm	16 x 8 mm	20 x 4 mm	20 x 6 mm	20 x 8 mm	25 x 4 mm	30 x 8 mm	40 x 8 mm
	Art.	Art.	Art.	Art.	Art.	Art.	Art.	Art.	Art.	Art.	Art.	Art.
Ø 100 mm	157/1	1320/7	1320/10	1320/1	1802/1	1802/2	157/6	1320/4	1802/3	157/11	1802/112	1802/113
Ø 105 mm	1802/4	1802/5	1802/6	1802/7	1802/8	1802/9	1802/10	1802/11	1802/12	-	1802/62	1802/63
Ø 110 mm	1802/13	1802/14	1802/15	1802/16	1802/17	1802/18	1802/19	1802/20	1802/21	-	1802/66	1802/67
Ø 115 mm	157/2	1320/8	1320/11	1320/2	1802/22	1802/23	157/7	1320/5	1802/24	157/12	1802/71	1802/72
Ø 120 mm	1802/25	1802/26	1802/27	1802/28	1802/29	1802/30	1802/31	1802/32	1802/33	-	1802/75	1802/76
Ø 130 mm	157/3	1320/9	1320/12	1320/3	1802/34	1802/35	157/8	1320/6	1802/36	157/13	1802/80	1802/81
Ø 160 mm	157/4	1802/37	1802/38	1802/39	1802/40	1802/41	157/9	1802/42	1802/43	157/14	1802/86	1802/87
Ø 180 mm	1802/44	1802/45	1802/46	1802/47	1802/48	1802/49	1802/50	1802/51	1802/52	-	1802/94	1802/95
Ø 190 mm	157/5	-	-	-	-	-	157/10	-	-	157/15	-	-
Ø 200 mm	1802/53	1802/54	1802/55	1802/56	1802/57	1802/58	1802/59	1802/60	1802/61	-	1802/103	1802/104

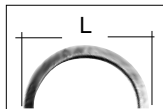

Section - Sezione  
∅ 12 x 12 mm



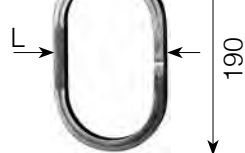

	Art.	Art.
plain liscio	L 100 mm 491/8	1317/3
	L 115 mm 1317/1	1317/4
	L 130 mm 1317/2	1317/5
Bark effect corteccia	L 100 mm 1317/18	1317/21
	L 115 mm 1317/19	1317/22
	L 130 mm 1317/20	1317/23
diamond diamantato	L 100 mm 1318/1	1318/4
	L 115 mm 1318/2	1318/5
	L 130 mm 1318/3	1318/6
hammered spigolato	L 100 mm 491/9	1318/9
	L 115 mm 1318/7	1318/10
	L 130 mm 1318/8	1318/11
rigato grooved	L 100 mm 1318/12	1318/15
	L 115 mm 1318/13	1318/16
	L 130 mm 1318/14	1318/17
four-leaf clover quadrifoglio	L 100 mm 1319/2	-
	L 115 mm 1319/3	-
	L 130 mm 1319/3	1319/6



OVAL RINGS - CERCHI OVALI

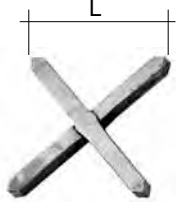

H x L mm	∅ 10 mm	∅ 12 mm	∅ 12 x 12 mm	12 x 6 mm	14 x 6 mm	14 x 8 mm	16 x 4 mm	20 x 4 mm	20 x 6 mm
190 x 100 mm	Art. 1317/12	1317/15	1317/3	1320/22	1320/19	1320/28	1320/13	1320/25	1320/16
190 x 115 mm	1317/13	1317/16	1317/4	1320/23	1320/20	1320/29	1320/14	1320/26	1320/17
190 x 130 mm	1317/14	1317/17	1317/5	1320/24	1320/21	1320/30	1320/15	1320/27	1320/18

					
plain - liscio Art. 156/1 ∅ 12 x 12 mm 117 x 165 mm	with 4 stamps con 4 stampate Art. 156/2 ∅ 12 x 12 mm 125 x 175 mm	with 8 stamps con 8 stampate Art. 156/3 ∅ 12 x 12 mm 130 x 170 mm	Art. 1321/9 ∅ 12 x 12 mm L 100 x 100 mm Art. 1321/11 ∅ 14 x 14 mm L 100 x 100 mm	hammered spigolato Art. 1803/1 ∅ 12 x 6 mm ∅ 100 mm Art. 1803/2 ∅ 12 x 6 mm ∅ 115 mm Art. 1803/3 ∅ 12 x 6 mm ∅ 130 mm	plain liscio ∅ 12 x 6 mm Art. 1299/5 ∅ 100 mm Art. 1299/6 ∅ 130 mm  ∅ 14 x 6 mm Art. 1299/7 ∅ 100 mm Art. 1299/8 ∅ 130 mm
Art. 156/4 ∅ 14 x 14 mm 170 x 240 mm	Art. 156/5 ∅ 14 x 14 mm 176 x 249 mm	Art. 156/6 ∅ 14 x 14 mm 192 x 273 mm			





Arteferro scrolls and snap-ons have been designed to embellish even the simplest wrought iron composition. Like the other Arteferro decorative elements, they can be used in many different projects, from gates to the railings, as well as on stairways and balconies. Even a fence or a balustrade with vertical posts made of plain iron can be embellished at a later time by these useful decorative items.

I ricci e gli snap-ons Arteferro sono stati ideati per impreziosire anche la più semplice composizione in ferro battuto. Come gli altri elementi decorativi Arteferro, trovano applicazione in molteplici realizzazioni, dalla cancellate alle inferriate, così come nelle scale e nelle balconate. Anche una recinzione o un parapetto in paletti verticali di ferro liscio può essere arricchita in un secondo momento con l'utilizzo di questi utili elementi decorativi.

**RICCI E SNAP-ONS**

**SCROLLS AND SNAP-ONS**

11

Scrolls and Snap-ons  
Ricci e Snap-ons



11.A Scrolls ..... pag.198

Ricci

11.B Snap-ons ..... pag.215

This section will give you an overview of Arteferro scrolls. The main characteristic element of a scroll is the end. We have organised the items upon this, in accordance with their style or the manufacturing used. Once you've chosen the end, you can find your scroll.

Questo capitolo vi darà una panoramica dei ricci Arteferro. Principale elemento caratterizzante di un riccio è il terminale. Su questo abbiamo organizzato gli articoli, in base allo stile o alla lavorazione. Scelto il terminale, trovi il tuo riccio.

Cold cut ends  
Terminali tranciati  
a freddo

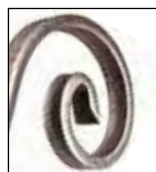

Section Sezione	L 120 mm H 360 mm Art.	L 120 mm H 360 mm Art.	L 120 mm H 290 mm Art.	L 108 mm H 220 mm Art.	L 60 mm H 115 mm Art.	L 90 mm H 180 mm Art.
ϕ 8 x 8 mm	74/6	74/12	74/18	74/24	78/6	78/12
ϕ 10 x 5 mm	74/1	74/7	74/13	74/19	78/1	78/7
ϕ 12 x 6 mm	74/2	74/8	74/14	74/20	78/2	78/8
ϕ 14 x 6 mm	74/25	74/27	74/26	74/28	78/14	78/13
ϕ 16 x 4 mm	74/3	74/9	74/15	74/21	78/3	78/9
ϕ 20 x 4 mm	74/4	74/10	74/16	74/22	78/4	78/10
ϕ 20 x 6 mm	74/5	74/11	74/17	74/23	78/5	78/11

Hot forged cut ends  
Terminali fucinati  
a caldo e tranciati

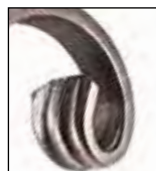

Section Sezione	L 75 mm H 120 mm Art.	L 75 mm H 160 mm Art.	L 75 mm H 130 mm Art.	L 75 mm H 150 mm Art.	L 65 mm H 150 mm Art.	L 70 mm H 190 mm Art.
ϕ 12 x 6 mm	80/B/8	88/H/4	88/H/3	88/H/2	80/A/11	80/A/12
ϕ 14 x 6 mm	-	-	-	-	80/A/26	80/A/27
ϕ 16 x 4 mm	80/B/3	-	-	-	80/A/19	80/A/20

Hot forged cut ends  
Terminali fucinati  
a caldo e tranciati



Section Sezione	L 68 mm H 110 mm Art.	L 70 mm H 105 mm Art.	L 70 mm H 100 mm Art.	L 95 mm H 140 mm Art.
ϕ 12 x 6 mm	80/A/31	80/A/9	80/A/32	80/A/10
ϕ 14 x 6 mm	-	80/A/24	-	80/A/25
ϕ 16 x 4 mm	-	80/A/17	-	80/A/18

Plain-Liscio

1368/2  
ϕ 8 x 8 mm

Plain-Liscio

- 1368/11
- ϕ 10 x 5 mm
- 1368/12
- ϕ 12 x 6 mm
- 1368/41
- ϕ 14 x 6 mm
- 1368/14
- ϕ 16 x 4 mm
- 1368/15
- ϕ 20 x 4 mm
- 1368/16
- ϕ 20 x 6 mm

Plain-Liscio

- 1368/12
- ϕ 12 x 6 mm
- 1368/41
- ϕ 14 x 6 mm
- 1368/14
- ϕ 16 x 4 mm

Plain-Liscio

- 1368/12
- ϕ 12 x 6 mm
- 1368/41
- ϕ 14 x 6 mm
- 1368/14
- ϕ 16 x 4 mm



Hot forged ends  
Terminali fucinati  
a caldo



Section Sezione	L 65 mm H 95 mm Art.	L 70 mm H 110 mm Art.	L 60 mm H 120 mm Art.	L 80 mm H 130 mm Art.	L 80 mm H 145 mm Art.	L 80 mm H 190 mm Art.	L 100 mm H 260 mm Art.
∅ 12 x 6 mm	80/C/8	80/C/7	80/C/9	80/C/10	80/C/11	80/C/14	80/C/13
∅ 14 x 6 mm	80/C/18	80/C/17	80/C/19	80/C/20	80/C/21	80/C/24	80/C/23

Plain  
Liscio

1368/12

∅ 12 x 6 mm

1368/41

∅ 14 x 6 mm

Hot forged cut ends  
Terminali fucinati  
a caldo e tranciati



Section Sezione	L 110 mm H 270 mm Art.	L 100 mm H 270 mm Art.	L 110 mm H 280 mm Art.	L 100 mm H 270 mm Art.
∅ 12 x 6 mm	80/A/1	80/A/2	80/A/5	80/A/4
∅ 14 x 6 mm	80/A/28	-	80/A/1/S8	-
∅ 16 x 4 mm	80/A/21	-	-	-
∅ 16 x 6 mm	80/A/14	-	-	-

Plain  
Liscio

1368/12

∅ 12 x 6 mm

1368/41

∅ 14 x 6 mm

1368/14

∅ 16 x 4 mm

1368/43

∅ 16 x 6 mm

Hot forged cut ends  
Terminali fucinati  
a caldo e tranciati



Section Sezione	L 60 mm H 100 mm Art.	L 60 mm H 110 mm Art.	L 60 mm H 115 mm Art.	L 75 mm H 125 mm Art.	L 110 mm H 150 mm Art.
∅ 12 x 6 mm	80/A/6	80/A/3	80/A/7	80/A/8	80/A/13
∅ 14 x 6 mm	-	80/A/29	-	-	80/A/30
∅ 16 x 4 mm	-	80/A/22	-	-	80/A/23
∅ 16 x 6 mm	-	80/A/15	-	-	80/A/16

Plain  
Liscio

1368/12

∅ 12 x 6 mm

1368/41

∅ 14 x 6 mm

1368/14

∅ 16 x 4 mm

1368/43

∅ 16 x 6 mm





Plain-Liscio  
1368/4  
Φ 12 x 12 mm  
1368/5  
Φ 14 x 14 mm



Hammered Spigolato  
118/1  
Φ 12 x 12 mm  
118/2  
Φ 14 x 14 mm



Plain-Liscio  
1368/4  
Φ 12 x 12 mm



Hammered Spigolato  
118/1  
Φ 12 x 12 mm

Hot forged scroll  
Venetian style  
Riccio fucinato  
a caldo "veneziana"



Section Sezione	L 90 mm H 145 mm Art.	L 95 mm H 150 mm Art.	L 105 mm H 220 mm Art.	L 105 mm H 220 mm Art.	L 105 mm H 300 mm Art.
Φ 12 x 12 mm	-	94/Q/5	94/P/1	94/Q/1	94/P/9
Φ 14 x 14 mm	88/I/3	94/Q/6	94/P/2	94/Q/2	94/P/10

Φ 12 x 12 mm	94/Q/3	94/Q/7	94/P/3	94/Q/3	94/P/11
Φ 14 x 14 mm	88/I/2	94/Q/8	94/P/4	94/Q/4	94/P/12

Hot forged scroll  
Venetian style  
Riccio fucinato  
a caldo "veneziana"



Section Sezione	L 65 mm H 105 mm Art.	L 110 mm H 160 mm Art.	L 185 mm H 160 mm Art.	L 180 mm H 445 mm Art.	L 240 mm H 455 mm Art.
Φ 12 x 12 mm	1046/7	1046/6	1046/4	1046/5	1046/3

Hot forged ends  
Terminali fucinati  
a caldo



Section Sezione	L 190 mm H 385 mm Art.	L 80 mm H 560 mm Art.
Φ 12 x 12 mm	88/L/3	88/L/4



Hot forged ends  
Baroque style  
Terminali fucinati  
a caldo "barocco"



Section Sezione	L 120 mm H 360 mm Art.	L 120 mm H 360 mm Art.	L 120 mm H 290 mm Art.	L 120 mm H 220 mm Art.	L 115 mm H 255 mm Art.	L 90 mm H 180 mm Art.	L 60 mm H 115 mm Art.
Ø 12 mm	1295/1	1295/2	1295/3	1295/4	1295/5	1295/6	1295/7

Plain-Liscio

1368/9  
Ø 12 mm

Hot forged ends  
Baroque style  
Terminali fucinati  
a caldo "barocco"



Section Sezione	L 120 mm H 260 mm Art.	L 95 mm H 260 mm Art.	L 100 mm H 260 mm Art.	L 90 mm H 135 mm Art.	L 70 mm H 110 mm Art.
Ø 12 mm	1296/9	1296/10	1296/11	1296/12	1296/13

Hammered  
Battuto

600/4  
Ø 12 mm

Hot forged ends  
Baroque style  
Terminali fucinati  
a caldo "barocco"



Section Sezione	L 60 mm H 115 mm Art.	L 70 mm H 115 mm Art.	L 90 mm H 140 mm Art.	L 90 mm H 180 mm Art.
Ø 12 x 6 mm	1296/6	1296/8	1296/7	1296/5

Diamond  
Diamantato

623/1  
Ø 12 x 6 mm

Hot forged ends  
Baroque style  
Terminali fucinati  
a caldo "barocco"



Section Sezione	L 120 mm H 220 mm Art.	L 120 mm H 290 mm Art.	L 120 mm H 360 mm Art.	L 120 mm H 360 mm Art.
Ø 12 x 6 mm	1296/4	1296/3	1296/2	1296/1

Diamond  
Diamantato

623/1  
Ø 12 x 6 mm

Hot forged ends  
"baroque cut"  
Terminali fucinati  
a caldo  
"barocco rifilato"

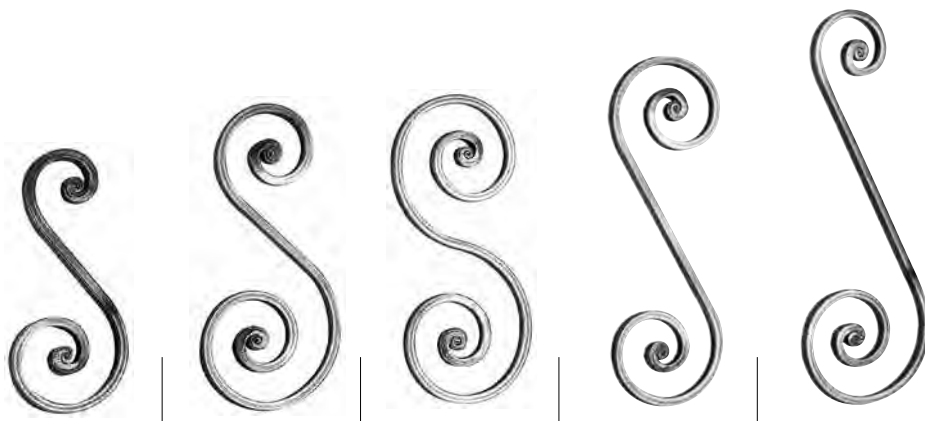

Section Sezione	L 100 mm H 220 mm Art.	L 120 mm H 280 mm Art.	L 120 mm H 280 mm Art.	L 120 mm H 330 mm Art.	L 120 mm H 390 mm Art.
∅ 14 x 8 mm	1301/5	1301/4	1301/3	1301/2	1301/1

Plain-Liscio  
1368/13  
∅ 14 x 8 mm

Hot forged ends  
"baroque cut"  
Terminali fucinati  
a caldo  
"barocco rifilato"

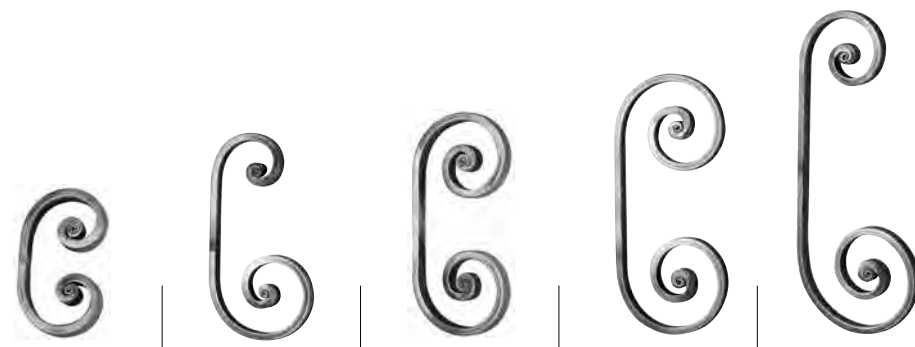

Section Sezione	L 70 mm H 130 mm Art.	L 100 mm H 160 mm Art.	L 100 mm H 210 mm Art.	L 120 mm H 260 mm Art.	L 120 mm H 325 mm Art.
∅ 14 x 8 mm	1301/10	1301/8	1301/9	1301/7	1301/6

Plain-Liscio  
1368/13  
∅ 14 x 8 mm





Plain-Liscio

- 1368/4
- Ø 12 x 12 mm
- 1368/5
- Ø 14 x 14 mm
- 1368/13
- Ø 14 x 8 mm

Hot forged ends  
Terminali fucinati  
a caldo



Section Sezione	L 80 mm H 130 mm Art.	L 80 mm H 160 mm Art.	L 130 mm H 290 mm Art.	L 110 mm H 220 mm Art.	L 110 mm H 220 mm Art.	L 110 mm H 300 mm Art.
Ø 12 x 12 mm	-	-	-	78/B/1	78/B/2	78/B/3
Ø 14 x 14 mm	-	-	-	78/B/4	78/B/5	78/B/6
Ø 14 x 8 mm	88/P/3	88/P/2	88/P/1	-	-	-



Plain-Liscio

- 1368/12
- Ø 12 x 6 mm

Cold stamped scrolls  
Ricci stampati  
a freddo



Section Sezione	L 70 mm H 110 mm Art.	L 73 mm H 123 mm Art.	L 80 mm H 130 mm Art.	L 80 mm H 150 mm Art.	L 90 mm H 160 mm Art.	L 95 mm H 210 mm Art.
Ø 12 x 6 mm	88/A/3	88/10	87/1	87/6	87/5	86/5



**i** Arteferro products can be manufactured as well as customised.  
I prodotti Arteferro sono realizzabili anche su misura.

Cold cut ends  
Terminali tranciati  
a freddo



Section Sezione	L 60 mm H 115 mm Art.	L 90 mm H 180 mm Art.	L 120 mm H 220 mm Art.	L 120 mm H 290 mm Art.	L 120 mm H 360 mm Art.	L 120 mm H 360 mm Art.
∅ 12 x 6 mm	641/3	641/4	641/5	641/6	641/7	641/8

Diamond  
Diamantato  
623/1  
∅ 12 x 6 mm

Hot forged  
scrolls  
Ricci fucinati  
a caldo



Section Sezione	L 70 mm H 105 mm Art.	L 70 mm H 130 mm Art.
∅ 12 x 6 mm	641/1	641/2

Diamond  
Diamantato  
623/1  
∅ 12 x 6 mm

Hot forged ends  
Terminali fucinati  
a caldo



Section Sezione	L 60 mm H 120 mm Art.	L 120 mm H 290 mm Art.	L 120 mm H 360 mm Art.
∅ 10 mm	1297/7	1297/3	1297/2



Notched  
Tacchettato  
622/1  
∅ 12 x 6 mm

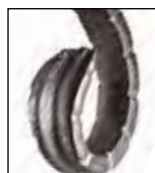

Art. 64/G/3 ∅ 12 x 6 mm 105 x 150 mm	Art. 64/G/6 ∅ 12 x 6 mm 50 x 230 mm	Art. 64/G/4 ∅ 12 x 6 mm 60 x 105 mm	Art. 64/G/5 ∅ 12 x 6 mm 60 x 105 mm
--	---	---	---

Hot forged ends  
Terminali fucinati a caldo



Scrolls - Ricci

Ends with sphere  
Terminali con pallina



Section Sezione	L 150 mm H 350 mm Art.	L 150 mm H 350 mm Art.
∅ 12 x 12 mm	1308/12	-
∅ 14 x 14 mm	1308/13	
∅ 12 mm	-	
∅ 14 mm	-	1308/8
∅ 16 mm	-	1308/9

Hot forged ends  
Terminali fucinati a caldo

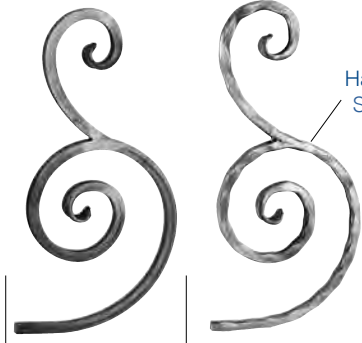
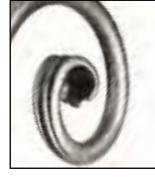

Hammered  
Spigolato

Section Sezione	L 180 mm H 360 mm Art.	L 180 mm H 360 mm Art.
∅ 12 x 12 mm	1308/1	1308/3
∅ 14 x 14 mm	1308/2	1308/4
∅ 12 mm	-	-
∅ 14 mm	1308/11	-
∅ 16 mm	1308/7	-

Hot forged ends  
Terminali fucinati a caldo

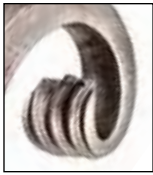

Section Sezione	L 65 mm H 130 mm Art.	L 80 mm H 130 mm Art.
∅ 12 x 12 mm	658/8	658/7
∅ 12 mm	659/11	659/10

Hot forged end  
Terminale fucinato a caldo



Notched  
Tacchettato  
622/1  
∅ 12 x 6 mm

Section Sezione	L 60 mm H 110 mm Art.	L 110 mm H 270 mm Art.
∅ 12 x 6 mm	88/N/6	88/N/3

Hot forged scroll  
Riccio battuti a caldo

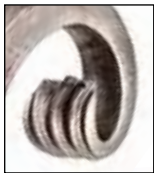

Hot forged scroll  
Venetian style  
Riccio fucinato a caldo "veneziana"



NEW

NEW

Art. 78/15  
∅ 30 x 8 mm  
60 x 130 mm

Art. 78/16  
∅ 30 x 8 mm  
60 x 130 mm





Notched - Tacchettato

622/1  
Ø 12 x 6 mm

Cold cut ends  
Terminali tranciati  
a freddo



Section Sezione	L 50 mm H 75 mm Art.	L 60 mm H 115 mm Art.	L 90 mm H 180 mm Art.	L 120 mm H 290 mm Art.	L 120 mm H 360 mm Art.
Ø 10 x 5 mm	88/N/7	-	-	-	-
Ø 12 x 6 mm	-	88/N/5	88/N/4	88/N/2	88/N/1



Plain - Liscio

1368/7  
Ø 8 mm  
1368/78  
Ø 10 mm

Cold stamped scrolls  
Ricci stampati  
a freddo



Section Sezione	L 85 mm H 115 mm Art.	L 73 mm H 122 mm Art.	L 73 mm H 122 mm Art.	L 73 mm H 122 mm Art.
Ø 8 x 8 mm	81/1	* 81/3	* 81/5	* 81/7
Ø 8 mm	-	-	-	82/3
Ø 10 mm	-	-	-	82/5



\*Notched - Tacchettato

622/2  
Ø 8 x 8 mm

Cold cut ends  
Terminali tranciati  
a freddo



Section Sezione	L 95 mm H 190 mm Art.	L 150 mm H 225 mm Art.	L 70 mm H 140 mm Art.	L 120 mm H 300 mm Art.
Ø 16 x 4 mm	-	-	84/6	84/5
Ø 20 x 6 mm	84/8	84/7	-	-



Plain - Liscio

1368/16  
Ø 20 x 6 mm

Cold cut ends  
Terminali tranciati  
a freddo



Section Sezione	L 75 mm H 120 mm Art.	L 90 mm H 240 mm Art.	L 125 mm H 270 mm Art.	L 120 mm H 305 mm Art.
Ø 16 x 4 mm	87/3	84/2	87/4	84/1



Plain - Liscio





1368/14  
Ø 16 x 4 mm

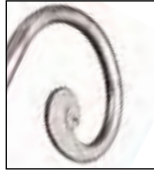

Cold stamped scrolls  
Ricci stampati  
a freddo

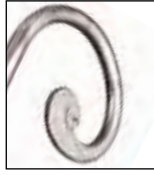



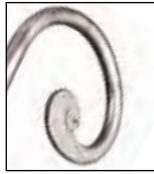

Plain - Liscio  
1368/8  
Ø 10 mm

				
Section Sezione	L 270 mm H 130 mm Art.	L 100 mm H 180 mm Art.	L 150 mm H 210 mm Art.	L 130 mm H 270 mm Art.
Ø 10 mm	642/3	1290/3	1291/3	1291/5

Cold stamped scrolls  
Ricci stampati  
a freddo

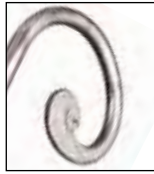

Plain - Liscio  
1368/8  
Ø 10 mm



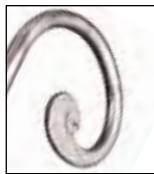

				
Section Sezione	L 110 mm H 230 mm Art.	L 110 mm H 300 mm Art.	L 400 mm H 180 mm Art.	L 210 mm H 280 mm Art.
Ø 10 mm	1290/2	1290/1	642/4	1291/4

**i** Arterferro products can be manufactured as well as customised.  
I prodotti Arterferro sono realizzabili anche su misura.

Cold stamped scrolls  
Ricci stampati  
a freddo

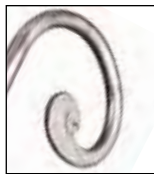

Plain - Liscio  
1368/8  
Ø 10 mm

				
Section Sezione	L 300 mm H 400 mm Art.	L 315 mm H 475 mm Art.	L 130 mm H 900 mm Art.	L 220 mm H 900 mm Art.
Ø 10 mm	1291/2	1291/1	642/1	642/2



Cold stamped scrolls  
Ricci stampati a freddo



Plain - Liscio  
1368/2  
Ø 8 x 8 mm



Art. 73/1  
Ø 8 x 8 mm  
110 x 300 mm



Art. 73/2  
Ø 8 x 8 mm  
110 x 230 mm



Art. 73/3  
Ø 8 x 8 mm  
80 x 180 mm



Hot forged ends  
Baroque style  
Terminali fucinati  
a caldo "barocco"



Section Sezione	L 70 mm H 120 mm Art.	L 100 mm H 160 mm Art.	L 200 mm H 300 mm Art.	L 200 mm H 320 mm Art.	L 200 mm H 320 mm Art.	L 110 mm H 690 mm Art.
Ø 16 x 8 mm	655/1	655/2	655/3	655/4	655/5	656/1

Hammered  
4 edges  
Spigolato  
4 spigoli  
1839/24  
Ø 16 x 8 mm



Plain - Liscio

- 1368/12
- Ø 12 x 6 mm
- 1368/14
- Ø 16 x 4 mm
- 1368/15
- Ø 20 x 4 mm

Cold cut ends  
Terminali tranciati  
a freddo



Section Sezione	L 90 mm H 130 mm Art.	L 80 mm H 320 mm Art.	L 100 mm H 320 mm Art.
Ø 12 x 6 mm	88/4	88/1	76/1
Ø 16 x 4 mm	88/5	88/2	76/2
Ø 20 x 4 mm	88/6	88/3	76/3

**i** Arterferro products can be manufactured as well as customised.  
I prodotti Arterferro sono realizzabili anche su misura.

Hot forged ends  
Terminali fucinati  
a caldo

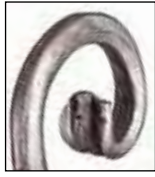

Sezione	L 90 mm H 180 mm Art.	L 120 mm H 220 mm Art.	L 80 mm H 245 mm Art.	L 120 mm H 290 mm Art.
Ø 8 mm	646/4	646/5	646/3	646/8

Hammered  
Battuto  
Art. 600/2  
Ø 8 mm

Hot forged ends  
Terminali fucinati  
a caldo



Sezione	L 120 mm H 360 mm Art.	L 120 mm H 360 mm Art.	L 100 mm H 900 mm Art.	L 250 mm H 900 mm Art.
Ø 8 mm	646/6	646/7	-	-
Ø 12 mm	-	-	646/1	646/2

Hammered  
Battuto  
Art. 600/2  
Ø 12 mm  
Art. 600/4  
Ø 12 mm

Cold cut ends  
Terminali tranciati  
a freddo



Sezione	L 125 mm H 350 mm Art.
Ø 10 x 5 mm	75/31
Ø 12 x 6 mm	75/32
Ø 8 x 8 mm	75/33

Plain  
Liscio  
1368/2  
Ø 8 x 8 mm  
1368/11  
Ø 10 x 5 mm  
1368/12  
Ø 12 x 6 mm



### Scrolls - Ricci

Hot forged scroll  
Venetian style  
Riccio fucinato  
a caldo "veneziana"



Section Sezione	L 100 mm H 120 mm Art.	L 80 mm H 130 mm Art.	L 120 mm H 190 mm Art.	L 115 mm H 260 mm Art.	L 125 mm H 310 mm Art.	L 80 mm H 320 mm Art.
∅ 20 x 10 mm	630/5	630/6	630/4	630/3	630/9	-
∅ 40 x 10 mm	-	-	-	-	-	630/2

Plain - Liscio  
1368/22  
∅ 20 x 20 mm

Plain - Liscio

1368/49  
∅ 20 x 10 mm  
1368/73  
∅ 40 x 10 mm

Hot forged scroll  
Venetian style  
Riccio fucinato  
a caldo "veneziana"



Section Sezione	L 125 mm H 330 mm Art.	L 112 mm H 339 mm Art.	L 205 mm H 360 mm Art.	L 210 mm H 400 mm Art.	L 200 mm H 470 mm Art.	L 240 mm H 470 mm Art.	L 190 mm H 580 mm Art.
∅ 20 x 10 mm	-	630/1	-	630/7	630/10	-	630/13
∅ 40 x 10 mm	630/12	-	630/11	-	-	-	-
∅ 20 x 20 mm	-	-	-	-	-	630/8	-

Plain - Liscio

1368/13  
∅ 14 x 8 mm

Hot forged ends  
"baroque cut"  
Terminali fucinati  
a caldo  
"barocco rifilato"

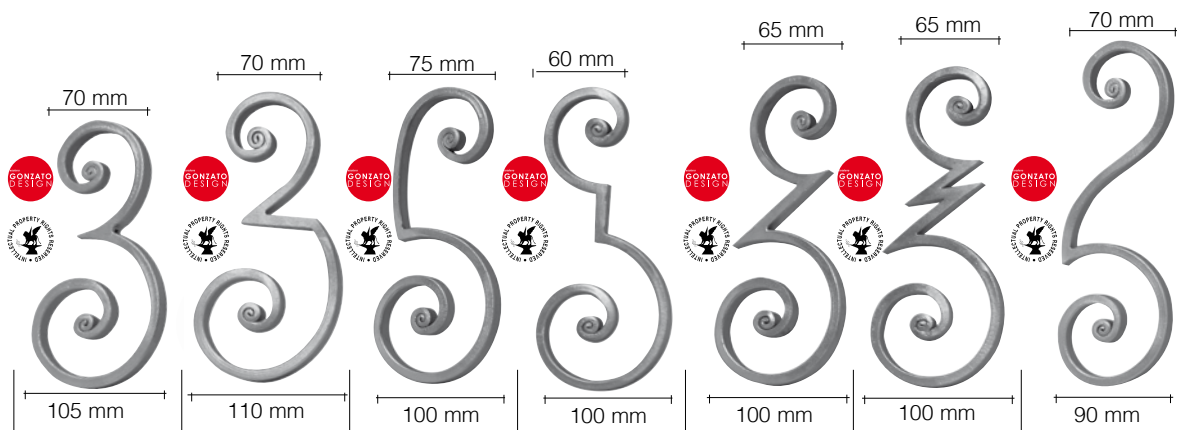

Sezione	L 105 mm H 200 mm Art.	L 110 mm H 215 mm Art.	L 100 mm H 220 mm Art.	L 100 mm H 220 mm Art.	L 100 mm H 230 mm Art.	L 100 mm H 237 mm Art.	L 95 mm H 270 mm Art.
∅ 14 x 8 mm	GD262/1	GD262/2	GD263/2	GD263/3	GD262/3	GD262/4	GD263/1

Hot forged cut ends  
Terminali fucinati  
a caldo rifilati



NEW



NEW



NEW



NEW



NEW



Plain - Liscio

- 1368/12
- ☒ 12 x 6 mm
- 1368/43
- ☒ 16 x 6 mm

Section Sezione	L 60 mm H 100 mm Art.	L 75 mm H 125 mm Art.	L 70 mm H 190 mm Art.	L 125 mm H 260 mm Art.	L 130 mm H 260 mm Art.	L 130 mm H 350 mm Art.
☒ 16 x 6 mm	1294/10	1294/11	1294/12	1294/13	1294/14	1294/15
☒ 12 x 6 mm	1294/16	1294/17	1294/18	1294/19	-	1294/20



Pag.  
112

In chapter 4  
you'll find the  
composite panels

Nel capitolo 4  
troverai i pannelli  
composti





Not all of the Arterferro items are available in **Arterferro Quick**, just a special selection. Find out about the entire range in the catalogue

In **Arterferro Quick** non sono presenti tutti gli articoli Arterferro, ma solo una speciale selezione. Scopri la gamma completa nel catalogo

*Compendium*

Hot forged plain ends  
Terminali fucinati a caldo lisci



Hot forged plain ends  
Terminali fucinati a caldo lisci



Section Sezione	L 180 mm H 180 mm Art.	L 190 mm H 190 mm Art.	L 210 mm H 210 mm Art.	L 210 mm H 210 mm Art.
Φ 14 x 14 mm	1665/10	* 1665/8	1665/14	* 1665/12
Φ 16 x 16 mm	1665/11	* 1665/9	1665/15	* 1665/13

\* articles not saleable in Spain

\* articoli non vendibili in Spagna

Plain - Liscio

1368/5

Φ 14 x 14 mm

1368/20

Φ 16 x 16 mm

Hot forged ends  
Venetian style  
Terminali fucinati a caldo con veneziana



Hot forged ends  
Venetian style  
Terminali fucinati a caldo con veneziana



Hot forged plain ends  
Terminali fucinati a caldo lisci



Section Sezione	L 85 mm H 110 mm Art.	L 100 mm H 340 mm Art.	L 100 mm H 340 mm Art.	L 200 mm H 340 mm Art.	L 200 mm H 390 mm Art.	L 180 mm H 380 mm Art.	L 180 mm H 380 mm Art.
Φ 14 x 14 mm	1665/1	1665/2	1665/3	1665/18	* 1665/16	1665/6	1665/4
Φ 16 x 16 mm	-	-	-	-	* 1665/17	1665/7	1665/5

\* articles not saleable in Spain

\* articoli non vendibili in Spagna



Art. 94/1  
 ∅ 12 x 6 mm  
 200 x 300 mm



Art. 94/2  
 ∅ 12 x 6 mm  
 150 x 200 mm



Art. 94/3  
 ∅ 12 x 6 mm  
 150 x 200 mm

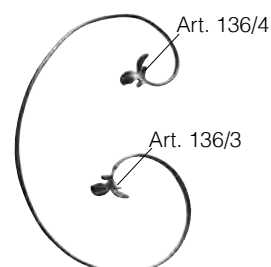

Art. 93/1  
 ∅ 12 x 6 mm  
 320 x 450 mm

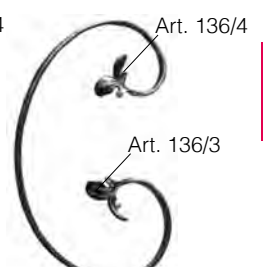

Art. 93/2  
 ∅ 12 x 6 mm  
 200 x 300 mm

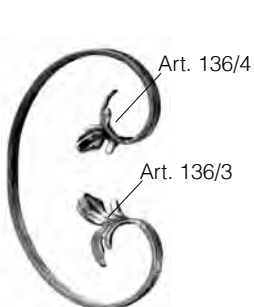

Art. 92/B/4  
 ∅ 12 x 6 mm  
 160 x 250 mm

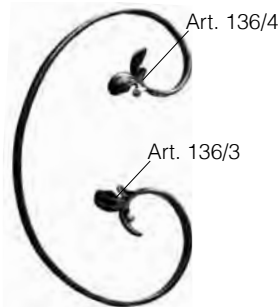

Art. 93/4  
 ∅ 12 x 6 mm  
 230 x 350 mm



Art. 92/B/3  
 ∅ 12 x 6 mm  
 80 x 350 mm



Art. 92/C/3  
 ∅ 12 x 6 mm  
 95 x 380 mm



Art. 93/3  
 ∅ 12 x 6 mm  
 200 x 450 mm



Arteferro scrolls from the 94 line adorn the balconies of the Chechen government headquarters in Grozny. I ricci Arteferro della linea 94 ornano i parapetti della sede del governo ceceno a Grozny.

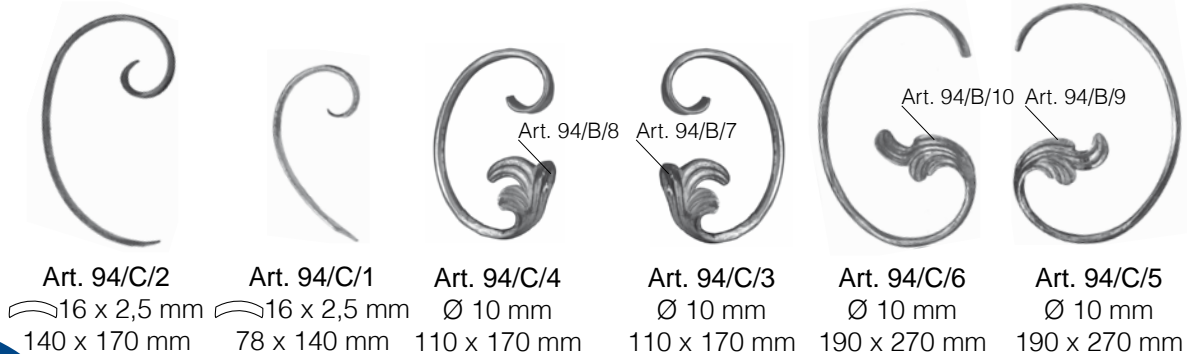

Art. 94/C/2 16 x 2,5 mm 140 x 170 mm  
 Art. 94/C/1 16 x 2,5 mm 78 x 140 mm  
 Art. 94/C/4 Ø 10 mm 110 x 170 mm  
 Art. 94/C/3 Ø 10 mm 110 x 170 mm  
 Art. 94/C/6 Ø 10 mm 190 x 270 mm  
 Art. 94/C/5 Ø 10 mm 190 x 270 mm

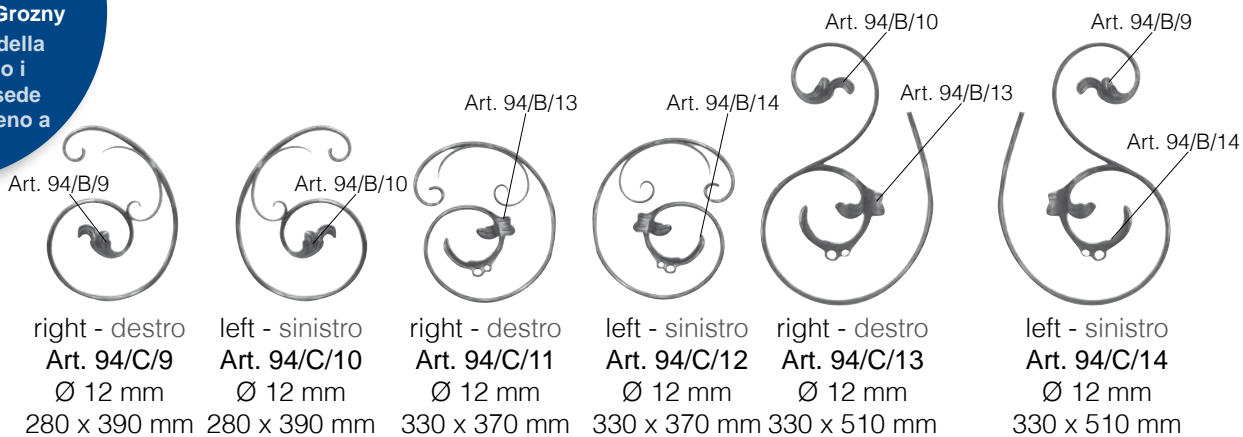

right - destro Art. 94/C/9 Ø 12 mm 280 x 390 mm  
 left - sinistro Art. 94/C/10 Ø 12 mm 280 x 390 mm  
 right - destro Art. 94/C/11 Ø 12 mm 330 x 370 mm  
 left - sinistro Art. 94/C/12 Ø 12 mm 330 x 370 mm  
 right - destro Art. 94/C/13 Ø 12 mm 330 x 510 mm  
 left - sinistro Art. 94/C/14 Ø 12 mm 330 x 510 mm

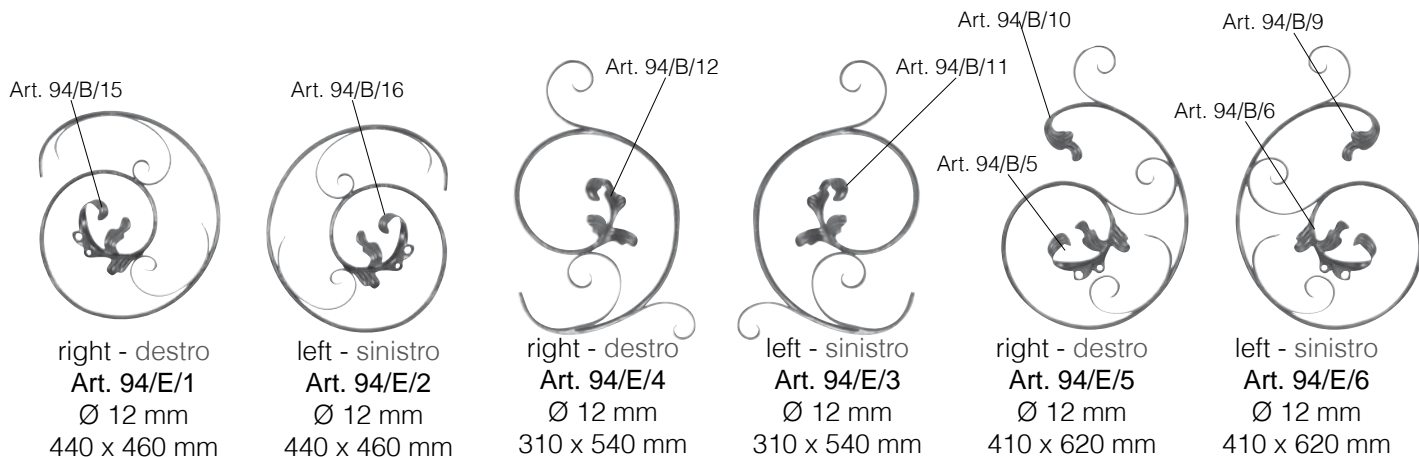

right - destro Art. 94/E/1 Ø 12 mm 440 x 460 mm  
 left - sinistro Art. 94/E/2 Ø 12 mm 440 x 460 mm  
 right - destro Art. 94/E/4 Ø 12 mm 310 x 540 mm  
 left - sinistro Art. 94/E/3 Ø 12 mm 310 x 540 mm  
 right - destro Art. 94/E/5 Ø 12 mm 410 x 620 mm  
 left - sinistro Art. 94/E/6 Ø 12 mm 410 x 620 mm

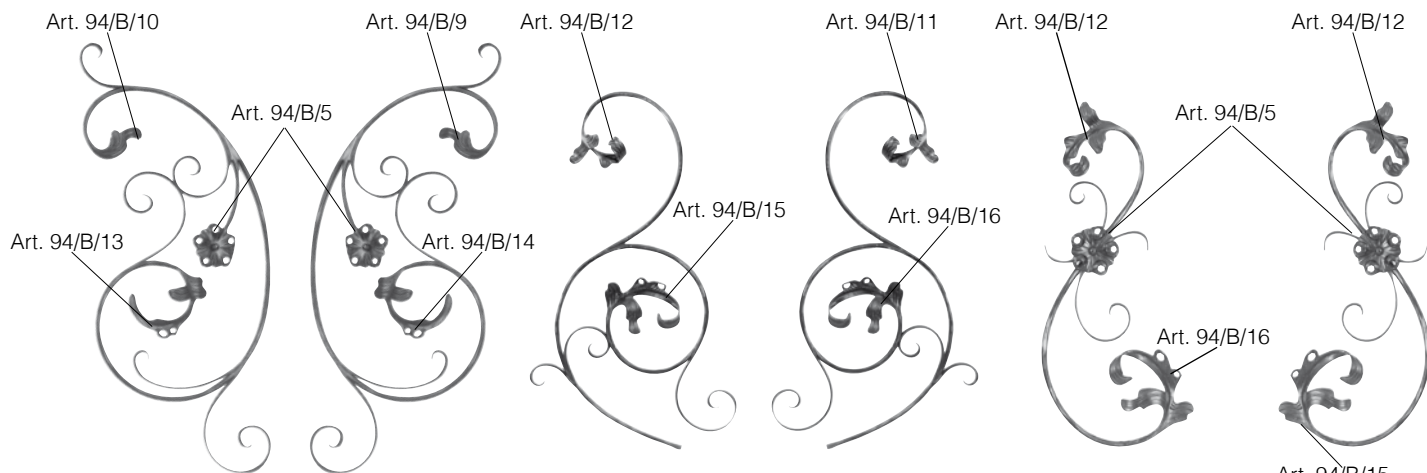

right - destro Art. 94/F/6 Ø 12 mm 420 x 970 mm  
 left - sinistro Art. 94/F/5 Ø 12 mm 420 x 970 mm  
 right - destro Art. 94/F/4 Ø 12 mm 490 x 800 mm  
 left - sinistro Art. 94/F/3 Ø 12 mm 490 x 800 mm  
 right - destro Art. 94/F/2 Ø 12 mm 320 x 690 mm  
 left - sinistro Art. 94/F/1 Ø 12 mm 320 x 690 mm



TO BE LAID OVERLAPPED ON  $\varnothing 12 \times 12 \text{ mm}$   
DA SOVRAPPORRE AL  $\varnothing 12 \times 12 \text{ mm}$



Art. 35/1  
 $\varnothing 12 \times 6 \text{ mm}$   
205 x 445 mm



Art. 582/1  
 $\varnothing 12 \times 6 \text{ mm}$   
175 x 350 mm



Art. 35/2  
 $\varnothing 12 \times 6 \text{ mm}$   
200 x 345 mm

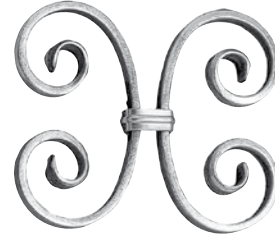

Art. 1300/2  
 $\varnothing 12 \times 6 \text{ mm}$   
145 x 175 mm



Art. 37/3  
 $\varnothing 12 \times 6 \text{ mm}$   
95 x 95 mm



A fence or a balcony made with pickets of simple plain iron, can be enhanced at a later time by the use of snap-ons

Una recinzione o un parapetto, realizzata con tamponatura in paletti di semplice ferro liscio, può essere arricchita in un secondo momento con l'utilizzo di snap-ons





**arteferro**  
italian wrought iron

# VERTICAL METALS

Si chiama Vertical Metals ed è la nuova linea di sistemi per facciate ornamentali marchiate Arteferro. Design brevettato, materiale green, può essere un rivestimento ma anche una struttura a sé stante, a copertura parziale o totale. Dalle epoche del Romanticismo e dell'Art Nouveau è la prima rielaborazione concettuale dell'utilizzo di un materiale classico come il ferro battuto che, pur mantenendo la tipica finitura artigianale, assume un design completamente nuovo dalle insolite tridimensionalità.

[arteferro.com/vertical\\_metals](http://arteferro.com/vertical_metals)

It's called Vertical Metals and is the new line for ornamental façades systems branded Arteferro. Patented design, green material, it can be a siding but also a stand-alone structure or a partial/total coverage. From the eras of Romanticism and Art Nouveau this is the first conceptual reworking of a classic material like wrought iron that, also maintaining the typical craftmade finishing, takes on a completely new design characterized by unusual tridimensionality.



[www.arteferro.com](http://www.arteferro.com)

Arteferro is a division of Ind.i.a. spa (Gonzato Group)  
Via Vicenza, 6/14 (SP46) – 36034 Malo (Vicenza) Italy  
Tel. +39 0445 580 580 • Fax +39 0445 580 874  
[info@arteferro.com](mailto:info@arteferro.com) • [www.arteferro.com](http://www.arteferro.com)

  
GONZATO GROUP

 **ind.i.a.**







Arteferro produces spheres with different finishes: plain, faceted, forged and hollow. The spheres are often combined with other wrought iron items, making it possible to create high quality decorative articles: they can be used as terminals for pickets or posts, as spacers, or as compositional elements for creating different organic shapes, like bunches of grapes.

Arteferro produce sfere con diverse finiture: lisce, diamantate, spicchiate e vuote. Le sfere vengono spesso abbinare ad altri elementi in ferro battuto, permettendo di realizzare manufatti decorativi di elevato pregio: possono essere utilizzate come terminali per paletti o caposaldi, come distanziali o come elementi compositivi per la realizzazione di diverse forme organiche come i grappoli d'uva.

					
Diameter Diametro	Hot stamped plain spheres Sfere lisce stampate a caldo	Handforged spheres Sfere forgiate a mano	Hollow spheres Sfere vuote	Welded hollow spheres 12.5 mm hole 2 mm thick Sfere vuote saldate foro 12,5 mm spess. 2 mm	hollow spheres not welded 3 mm thick Sfere vuote non saldate spessore 3 mm
	Art.	Art.	Art.	Art.	Art.
Ø 16 mm	117/1/L	 117/1	-	-	-
Ø 20 mm	116/F/1	117/2	-	-	-
Ø 22 mm	-	-	1394/2 Hole-Foro Ø 6 mm Thickn.-Spess. 2 mm	-	-
Ø 25 mm	116/F/2	117/3	1394/3 Hole-Foro Ø 6 mm Thickn.-Spess. 2 mm	1394/25	1395/5 hole-foro Ø 6 mm
Ø 30 mm	116/F/3	117/4	1394/4 Hole-Foro Ø 6 mm Thickn.-Spess. 2 mm	1394/24	1395/4 hole-foro Ø 6 mm
Ø 35 mm	123/1	117/5	-	-	1395/3 hole-foro Ø 12,5 mm
Ø 40 mm	116/F/4	117/6	1394/6 Hole-Foro Ø 7 mm Thickn.-Spess. 2 mm	1394/23	-
Ø 45 mm	-	-	1394/7 Hole-Foro Ø 8 mm Thickn.-Spess. 2 mm	-	-
Ø 50 mm	116/F/5	117/7	1394/8 Hole-Foro Ø 9 mm Thickn.-Spess. 2 mm	1394/22	1395/2 hole-foro Ø 16 mm
Ø 55 mm	-	-	1394/9 Hole-Foro Ø 9 mm Thickn.-Spess. 2 mm	-	-
Ø 60 mm	116/F/6	117/8	1394/10 Hole-Foro Ø 10 mm Thickn.-Spess. 2 mm	1394/21	-
Ø 70 mm	116/F/7	117/9	1394/11 Hole-Foro Ø 10 mm Thickn.-Spess. 2 mm	-	-
Ø 80 mm	116/F/8	113/12	1394/12 Hole-Foro Ø 11 mm Thickn.-Spess. 2 mm	-	1395/1 hole-foro Ø 35 mm
Ø 90 mm	116/F/9	-	1394/13 Without hole-Senza foro Thickn.-Spess. 2 mm	-	-
Ø 100 mm	116/F/10	113/11	1394/14 Without hole-Senza foro Thickn.-Spess. 2 mm	-	-
Ø 110 mm	-	-	1394/15 Without hole-Senza foro Thickn.-Spess. 2,5 mm	-	-
Ø 120 mm	116/F/17	117/15	1394/16 Without hole-Senza foro Thickn.-Spess. 2 mm	-	-
Ø 130 mm	-	-	1394/17 Without hole-Senza foro Thickn.-Spess. 2 mm	-	-
Ø 140 mm	-	-	1394/18 Without hole-Senza foro Thickn.-Spess. 2 mm	-	-
Ø 150 mm	116/F/19	117/16	1394/19 Without hole-Senza foro Thickn.-Spess. 2 mm	-	-
Ø 200 mm	-	-	1394/20 Without hole-Senza foro Thickn.-Spess. 1,5 mm	-	-

		
Diameter Diametro	Half hollow spheres hole 12.5 mm 2 mm thick Mezze sfere vuote foro 12,5 mm spess. 2 mm	Half full spheres Mezze sfere piene
	Art.	Art.
Ø 25 mm	1395/10	-
Ø 30 mm	1395/9	-
Ø 35 mm	-	819/14 H = 17,5 mm
Ø 40 mm	1395/8	819/13 H = 20 mm
Ø 50 mm	1395/7	819/12 H = 20 mm
Ø 55 mm	1395/6	-
Ø 60 mm	-	-
Ø 80 mm	-	-



	
Diameter Diametro	Pressed plain spheres Sfere lisce schiacciate
Ø 40 x H 25 mm	202/7
Ø 45 x H 28 mm	202/6
Ø 60 x H 35 mm	202/5
Ø 70 x H 40 mm	202/4
Ø 80 x H 51 mm	202/3
Ø 90 x H 57 mm	202/2
Ø 110 x H 67 mm	202/1

	
Diameter Diametro	Hot forged oval spheres Sfere forgiate ovali
Ø 28 x H 38 mm	1396/5
Ø 30 x H 50 mm	1396/4
Ø 40 x H 60 mm	1396/3
Ø 55 x H 75 mm	1396/2
Ø 65 x H 95 mm	1396/1

	
Diameter Diametro	Hot forged faceted spheres Sfere diamantate
Ø 20 mm	116/F/11
Ø 25 mm	116/F/12
Ø 30 mm	116/F/13
Ø 35 mm	116/F/14
Ø 40 mm	116/F/15
Ø 50 mm	116/F/16
Ø 60 mm	116/F/18



**BUSHES**

Arteferro bushes are compositional elements that are often used for the construction of wrought iron fences, railings, gates and balconies. Available in a range of versions, stamped, lathed, forged or tubular; with or without through holes, they can be fitted to pickets or posts and serve as a decorative element.

Le borchie Arteferro sono elementi compositivi spesso utilizzati per la realizzazione di recinzioni, inferriate, cancelli e balconate in ferro battuto. Disponibili in varie versioni, stampate, tornite, forgiate o in tubolare; con o senza foro passante, possono essere assemblate ai paletti o ai piantoni e fungono da elemento decorativo.

**BORCHIE**

HAND FORGED BUSHES - BORCHIE FORGIATE A MANO



Art. 1389/1  
33 x 200 mm  
□ 12 x 12 mm



Art. 1389/2  
53 x 200 mm  
□ 12 x 12 mm



Art. 1389/3  
53 x 200 mm  
Ø 12 mm



Art. 1389/4  
30 x 150 mm  
□ 12 x 12 mm



Art. 1389/5  
30 x 150 mm  
□ 12 x 12 mm



Art. 1389/6  
30 x 150 mm  
Ø 12 mm



Art. 738/1  
37 x 150 mm  
Ø 12 mm



Art. 738/2  
35 x 120 mm  
Ø 12 mm



Art. 738/3  
45 x 120 mm  
Ø 12 mm



Art. 738/4  
35 x 120 mm  
Ø 12 mm



Art. 738/5  
50 x 170 mm  
□ 14 x 14 mm



Art. 738/6  
50 x 170 mm  
□ 14 x 14 mm



Art. 738/7  
40 x 170 mm  
Ø 12 mm



Art. 738/8  
42 x 120 mm  
Ø 12 mm



Art. 738/9  
40 x 120 mm  
Ø 12 mm



Art. 738/10  
70 x 150 mm  
Ø 30 mm



Art. 738/11  
70 x 150 mm  
Ø 30 mm



H 40 mm  
Ø 45 mm

Art. 737/1  
hole - foro  
for/per Ø 16 mm

Art. 737/2  
hole - foro  
for/per Ø 18 mm

Art. 737/3  
hole - foro  
for/per Ø 20 mm



H 68 mm  
Ø 45 mm

Art. 737/4  
hole - foro  
for/per Ø 16 mm

Art. 737/5  
hole - foro  
for/per Ø 18 mm

Art. 737/6  
hole - foro  
for/per Ø 20 mm



Art. 737/7  
H 40 mm  
L 42 mm



Art. 737/8  
H 85 mm  
L 42 mm

**TUBE BUSHING**  
 Ø 30 mm thickness 1,5 mm

**BORCHIE IN TUBO**  
 Ø 30 mm spessore 1,5 mm



Art. 1243/1  
 H 180 mm  
 Ø 30 mm  
 hole for  
 foro per  
 Ø 12 mm



Art. 1243/2  
 H 140 mm  
 Ø 30 mm  
 hole for  
 foro per  
 Ø 12 mm



Art. 1243/3  
 H 60 mm  
 Ø 30 mm  
 hole for  
 foro per  
 Ø 12 mm



Art. 1243/4  
 H 150 mm  
 Ø 30 mm  
 hole for  
 foro per  
 Ø 12 mm



Art. 1243/5  
 H 330 mm  
 Ø 30 mm  
 hole for  
 foro per  
 Ø 12 mm



Art. 1243/6  
 H 185 mm  
 Ø 30 mm  
 hole for  
 foro per  
 Ø 12 mm



Art. 1243/7  
 H 100 mm  
 Ø 30 mm  
 hole for  
 foro per  
 Ø 12 mm



Art. 1243/8  
 H 70 mm  
 Ø 30 mm  
 hole for  
 foro per  
 Ø 12 mm



Art. 1243/9  
 H 155 mm  
 Ø 30 mm  
 hole for  
 foro per  
 Ø 12 mm



Art. 1243/10  
 H 145 mm  
 Ø 30 mm  
 hole for  
 foro per  
 Ø 12 mm



Art. 1243/11  
 H 155 mm  
 Ø 30 mm  
 hole for  
 foro per  
 Ø 12 mm



Art. 1243/12  
 H 90 mm  
 Ø 30 mm  
 hole for  
 foro per  
 Ø 12 mm



## TUBE BUSHING - BORCHIE IN TUBO

Ø 30 mm thickn.-spess. 1,5 mm - Ø 40 mm thickn.-spess. 2 mm - Ø 50 mm thickn.-spess. 2 mm



Art. 154/1  
H 120 mm  
Ø 30 mm

hole for - foro per dia.  
Ø 12 mm

## Art. 154/A/3

H 180 mm  
Ø 40 mm

hole for - foro per dia.  
Ø 16 mm



Art. 154/2  
H 150 mm  
Ø 30 mm

hole for - foro per dia.  
Ø 12 mm



Art. 154/3  
H 105 mm  
Ø 30 mm

hole for - foro per dia.  
Ø 12 mm



Art. 154/4  
H 140 mm  
Ø 30 mm

hole for - foro per dia.  
Ø 12 mm



Art. 154/5  
H 100 mm  
Ø 30 mm

hole for - foro per dia.  
Ø 12 mm



Art. 154/A/1  
H 105 mm  
Ø 40 mm

hole for - foro per dia.  
Ø 14 mm

## Art. 154/A/5

H 105 mm  
Ø 40 mm

hole for - foro per dia.  
Ø 16 mm

## Art. 154/B/1

H 105 mm  
Ø 40 mm

hole for - foro per dia.  
Ø 12 mm

## Art. 155/2

H 65 mm  
Ø 30 mm

hole for - foro per dia.  
Ø 12 mm



Art. 154/A/2  
H 75 mm  
Ø 40 mm

hole for - foro per dia.  
Ø 14 mm

## Art. 154/A/6

H 75 mm  
Ø 40 mm

hole for - foro per dia.  
Ø 16 mm

## Art. 154/B/2

H 75 mm  
Ø 40 mm

hole for - foro per dia.  
Ø 12 mm

## Art. 155/3

H 50 mm  
Ø 30 mm

hole for - foro per dia.  
Ø 12 mm



Art. 154/A/4  
H 120 mm  
Ø 40 mm

hole for - foro per dia.  
Ø 16 mm



Art. 155/1  
H 85 mm  
Ø 30 mm

hole for - foro per dia.  
Ø 12 mm



Art. 155/5  
H 85 mm  
Ø 30 mm

hole for - foro per dia.  
Ø 12 mm



Art. 155/6  
H 65 mm  
Ø 30 mm

hole for - foro per dia.  
Ø 12 mm



Art. 155/4  
H 20 mm  
Ø 30 mm

hole for - foro per dia.  
Ø 12 mm

## Art. 154/A/7

H 25 mm  
Ø 40 mm

hole for - foro per dia.  
Ø 16 mm



Art. 155/7  
H 30 mm  
Ø 30 mm

hole for - foro per dia.  
Ø 12 mm

## Art. 154/A/8

H 45 mm  
Ø 40 mm

hole for - foro per dia.  
Ø 16 mm



Art. 154/B/3  
H 120 mm  
Ø 40 mm

hole for - foro per dia.  
Ø 14 mm

## Art. 154/B/4

H 120 mm  
Ø 40 mm

hole for - foro per dia.  
Ø 16 mm



Art. 154/B/5  
H 95 mm  
Ø 40 mm

hole for - foro per dia.  
Ø 14 mm

## Art. 154/B/6

H 95 mm  
Ø 40 mm

hole for - foro per dia.  
Ø 16 mm



Art. 1793/7  
H 83 mm  
Ø 50 mm

hole for - foro per dia.  
Ø 22 mm



Art. 1793/8  
H 65 mm  
Ø 50 mm

hole for - foro per dia.  
Ø 22 mm



**TUBE BUSHING - BORCHIE IN TUBO**

hole for - foro per dia. 12 mm



Art. 742/3  
H 65 mm  
25 x 25 mm  
thickn.-spess.  
1,5 mm

Art. 742/4  
H 50 mm  
25 x 25 mm  
thickn.-spess.  
1,5 mm

hole for - foro per dia. 14 mm



Art. 742/1  
H 105 mm  
34 x 34 mm  
thickn.-spess.  
2 mm

Art. 742/2  
H 75 mm  
34 x 34 mm  
thickn.-spess.  
2 mm

hole for - foro per dia. 14 mm



Art. 742/5  
H 120 mm  
34 x 34 mm  
thickn.-spess.  
2 mm

Art. 742/6  
H 90 mm  
34 x 34 mm  
thickn.-spess.  
2 mm

**GROOVED STEEL TUBE BUSHING - BORCHIE IN TUBO RIGATO**

Hole for - Foro per dia. 12 mm thickn. - spess. 1,5 mm



Art. 1244/4  
H 150 mm  
Ø 30 mm



Art. 1244/1  
H 180 mm  
Ø 30 mm



Art. 1244/2  
H 140 mm  
Ø 30 mm



Art. 1244/3  
H 60 mm  
Ø 30 mm



Art. 1244/8  
H 70 mm  
Ø 30 mm



Art. 1244/7  
H 100 mm  
Ø 30 mm



Art. 1244/6  
H 185 mm  
Ø 30 mm



Art. 1244/5  
H 330 mm  
Ø 30 mm



Art. 1244/9  
H 140 mm  
Ø 30 mm



Art. 1244/10  
H 85 mm  
Ø 30 mm



Art. 1244/11  
H 100 mm  
Ø 30 mm



Art. 1244/12  
H 120 mm  
Ø 30 mm



Art. 1244/13  
H 85 mm  
Ø 30 mm



Art. 1244/14  
H 65 mm  
Ø 30 mm



Art. 1244/15  
H 30 mm  
Ø 30 mm



Art. 1244/16  
H 155 mm  
Ø 30 mm



Art. 1244/17  
H 145 mm  
Ø 30 mm



Art. 1244/18  
H 155 mm  
Ø 30 mm



Art. 1244/19  
H 90 mm  
Ø 30 mm



Art. 1244/20  
H 150 mm  
Ø 30 mm



Art. 1244/21  
H 105 mm  
Ø 30 mm







Art. 1244/22  
H 65 mm  
Ø 30 mm



Art. 1244/23  
H 50 mm  
Ø 30 mm

## STAMPED AND CAST BUSHES- BORCHIE STAMPATE E DI FUSIONE

	hole - foro 	 Stamped steel Ferro stampato	 Cast steel Ferro fuso	Hole - Foro 	 Stamped steel with insert Ferro stampato con inserto	 Cast steel Ferro fuso
Dimensions Dimensioni	Section Sezione	Art.	Art.	Section Sezione	Art.	Art.
H 63 mm Ø 38 mm	Without hole-Senza foro	128/3	-	-	-	-
	12 mm	128/6	747/18	12 x 12 mm	126/F/1	747/12
	14 mm	128/7	747/19	14 x 14 mm	-	-
	16 mm	128/8	747/20	16 x 16 mm	-	-
H 68 mm Ø 45 mm	Without hole-Senza foro	128/4	-	-	-	-
	12 mm	-	-	12 x 12 mm	126/F/2	1392/1
	14 mm	-	-	14 x 14 mm	126/F/3	747/13
	16 mm	128/9	-	16 x 16 mm	-	-
	18 mm	128/10	-	18 x 18 mm	-	-
	20 mm	128/11	-	20 x 20 mm	-	-
H 78 mm Ø 50 mm	Without hole-Senza foro	128/5	-	-	-	-
	12 mm	-	-	12 x 12 mm	-	-
	14 mm	-	-	14 x 14 mm	126/F/4	1392/2
	16 mm	128/12	-	16 x 16 mm	126/F/5	747/14
	18 mm	128/13	-	18 x 18 mm	-	-
	20 mm	128/14	-	20 x 20 mm	-	-
	22 mm	128/15	-	22 x 22 mm	-	-



STAMPED AND CAST BUSHES - BORCHIE STAMPATE E DI FUSIONE

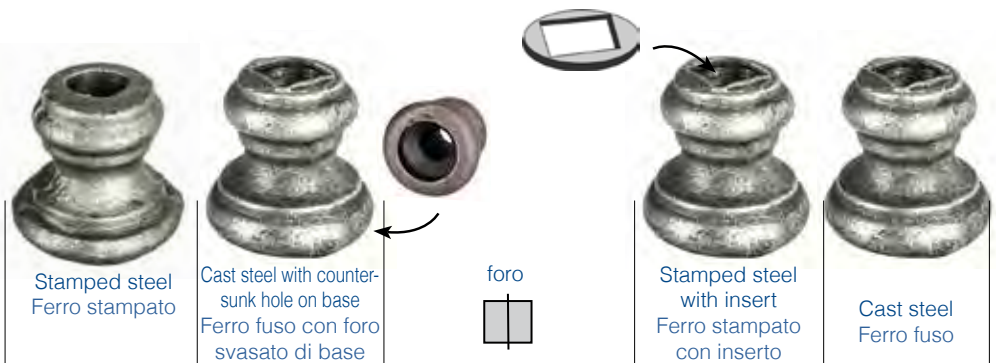

Dimensions Dimensioni	Section Sezione	Art.	Art.	Section Sezione	Art.	Art.
H 35 mm Ø 38 mm	Without hole-Senza foro	128/16	-	Without hole-Senza foro	-	-
	12 mm	128/17	747/21	12 x 12 mm	126/F/6	747/15
	14 mm	128/18	747/22	14 x 14 mm	-	-
	16 mm	128/19	747/23	16 x 16 mm	-	-
H 44 mm Ø 45 mm	Without hole-Senza foro	128/20	-	-	-	-
	12 mm	-	-	12 x 12 mm	126/F/7	1392/3
	14 mm	-	-	14 x 14 mm	126/F/8	747/16
	16 mm	128/21	-	16 x 16 mm	-	-
	18 mm	128/22	-	18 x 18 mm	-	-
	20 mm	128/23	-	20 x 20 mm	-	-
H 46 mm Ø 50 mm	Without hole-Senza foro	128/24	-	-	-	-
	12 mm	-	-	12 x 12 mm	-	-
	14 mm	-	-	14 x 14 mm	126/F/9	1392/4
	16 mm	128/25	-	16 x 16 mm	126/F/10	747/17
	18 mm	128/26	-	18 x 18 mm	-	-
	20 mm	128/27	-	20 x 20 mm	-	-
	22 mm	128/28	-	22 x 22 mm	-	-



Ø 40 mm - H 23 mm

hole - foro



Hole for section Foro per sezione	Art.
12 x 12 mm	128/38
14 x 14 mm	128/2
16 x 16 mm	128/39



Ø 40 mm - H 24 mm

hole - foro



Hole for section Foro per sezione	Art.
12 x 12 mm	1393/25
14 x 14 mm	1393/26



L 33 mm - H 22 mm

hole - foro



Hole for section Foro per sezione	Art.
12 x 12 mm	1393/19

L 55 mm - H 35 mm

hole - foro



Hole for section Foro per sezione	Art.
20 x 20 mm	1393/18

hole - foro



Hole for diameter Foro per diametro	Art.
Ø 12 mm	128/36
Ø 14 mm	128/1
Ø 16 mm	128/37

hole - foro



Hole for diameter Foro per diametro	Art.
Ø 12 mm	1393/27
Ø 14 mm	1393/28

## STAMPED BUSHES - BORCHIE STAMPATE



Hot stamped  
Stampata a caldo  
Ø 35 mm - H 63 mm



Hole for dia. - Foro per dia.	Art.
Without hole - Senza Foro	126/F/11
12 mm	739/4
14 mm	739/5
16 mm	739/6



Hot stamped  
Stampata a caldo  
Ø 35 mm - H 40 mm



Hole for dia. - Foro per dia.	Art.
12 mm	1854/1
14 mm	1854/2



Hot stamped with insert  
Stampata a caldo con inserto  
Ø 35 mm - H 40 mm



hole for sec. - foro per sez.	Art.
12 x 12 mm	1854/3



Hot stamped  
Stampata a caldo  
Ø 60 mm - H 65 mm



Hole for dia. - Foro per dia.	Art.
16 mm	1393/20
20 mm	1393/21
24 mm	1393/22



Cast steel  
Ferro fuso  
Ø 60 mm - H 65 mm



hole for sec. - foro per sez.	Art.
14 x 14 mm	1393/23
16 x 16 mm	1393/24



Not all of the Arteferro items are available in **Arteferro Quick**, just a special selection. Find out about the entire range in the catalogue

In **Arteferro Quick** non sono presenti tutti gli articoli Arteferro, ma solo una speciale selezione. Scopri la gamma completa nel catalogo

*Compendium*



Hot stamped with insert  
Stampata a caldo con inserto  
Ø 45 mm - H 54 mm



hole for sec. - foro per sez.	Art.
Without hole - Senza Foro	126/F/12
12 x 12 mm	126/F/13
14 x 14 mm	126/F/14



Cast steel  
Ferro fuso  
Ø 45 mm - H 54 mm



hole for sec. - foro per sez.	Art.
Without hole - Senza Foro	1392/5
12 x 12 mm	1392/6
14 x 14 mm	1392/7



Hot stamped  
Stampata a caldo  
Ø 45 mm - H 54 mm



Hole for dia. - Foro per dia.	Art.
12 mm	739/1
14 mm	739/2
16 mm	739/3

STAMPED BUSHES - BORCHIE STAMPATE



H 120 mm  
Ø 32 mm

H 63 mm  
Ø 32 mm

Hole for dia. - Foro per dia.	Art.	Art.
Without hole - Senza foro	-	128/C/15
Ø 12 mm	128/C/9	128/C/12
Ø 14 mm	128/C/10	128/C/13
Ø 16 mm	128/C/11	128/C/14



H 78 mm  
Ø 69 mm

H 50 mm  
Ø 69 mm

Hole for dia. - Foro per dia.	Art.	Art.
Without hole - Senza foro	128/C/3	741/6
Ø 20 mm	128/C/4	741/1
Ø 25 mm	128/C/5	741/2
Ø 30 mm	128/C/6	741/3
Ø 35 mm	128/C/7	741/4
Ø 40 mm	128/C/8	741/5



Cast steel  
Ferro fuso  
H 78 mm  
Ø 69 mm

hole for sec. - foro per sez.	Art.
25 x 25 mm	741/7
30 x 30 mm	741/8



Arteferro products are available in raw metal as well as sandblasted or galvanized on request.

I prodotti Arteferro sono disponibili in metallo grezzo e, su richiesta, anche sabbiati o zincati a freddo.



Dim.	Art.	Art.	Art.	Art.
H 55 mm Ø 35 mm	1393/14 hole for dia. - foro per dia. Ø 12 mm	1393/15 hole for dia. - foro per dia. Ø 14 mm	1393/16 hole for sec. - foro per sez. ⊓ 12 x 12 mm	-
H 75 mm Ø 50 mm	1393/10 hole for dia. - foro per dia. Ø 18 mm	1393/11 hole for dia. - foro per dia. Ø 20 mm	1393/12 hole for sec. - foro per sez. ⊓ 14 x 14 mm	1393/13 hole for sec. - foro per sez. ⊓ 16 x 16 mm



		Stamped steel with insert Ferro stampato con inserto	Cast steel Ferro fuso	Cast steel Ferro fuso	Cast steel Ferro fuso
Dim.	Hole for sec. - Foro per sez.	Art.	Art.	Art.	Art.
H 45 mm L 40 mm	12 x 12 mm	-	-	-	1391/21
	14 x 14 mm	-	-	-	1391/22
	16 x 16 mm	-	-	-	1391/23
H 65 mm L 40 mm	12 x 12 mm	-	-	1391/4	-
	14 x 14 mm	-	-	1391/5	-
	16 x 16 mm	-	-	1391/6	-
H 67 mm L 40 mm	Without hole-Senza foro	127/5	1391/18	-	-
	12 x 12 mm	127/7	1391/7	-	-
	14 x 14 mm	127/8	1391/8	-	-
	16 x 16 mm	127/9	1391/9	-	-
H 88 mm L 45 mm	Without hole-Senza foro	127/3	1391/17	-	-
	14 x 14 mm	127/10	1391/10	-	-
	16 x 16 mm	127/11	1391/11	-	-



Arteferro products are available in raw metal as well as sandblasted or galvanized on request.

I prodotti Arteferro sono disponibili in metallo grezzo e, su richiesta, anche sabbiati o zincati a freddo.



		Stamped steel with insert Ferro stampato con inserto	Cast steel Ferro fuso	Cast steel Ferro fuso
Dimens.	Hole for sec. - Foro per sez.	Art.	Art.	Art.
H 38 mm L 40 mm	Without hole - Senza Foro	127/6	1391/20	-
	12 x 12 mm	127/12	1391/12	-
	14 x 14 mm	127/13	1391/13	-
	16 x 16 mm	127/14	1391/14	-
H 40 mm L 40 mm	12 x 12 mm	-	-	1391/1
	14 x 14 mm	-	-	1391/2
	16 x 16 mm	-	-	1391/3
H 45 mm L 45 mm	Without hole - Senza Foro	127/4	1391/19	-
	14 x 14 mm	127/15	1391/15	-
	16 x 16 mm	127/16	1391/16	-





Arteferro baskets are central decorations, and are installed by welding the ends to the pickets they are inserted into. Their ornamental function confers an artistic dynamism to any structural element they are applied to, creating an elegant and sinuous wrought iron artefact.

Le pigne Arteferro sono decori centrali e vengono installate saldandone le estremità al paletto nel quale vengono inserite. La loro funzione ornamentale conferisce dinamicità artistica all'elemento strutturale al quale vien applicata, creando un manufatto in ferro battuto elegante e sinuoso.

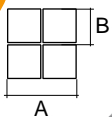

Art.	Ø	H	A	B
159/1	35 mm	90 mm	8 x 8 mm	4 x 4 mm
159/2	55 mm	110 mm	10 x 10 mm	5 x 5 mm
159/3 <b>BEST PRICE</b>	60 mm	125 mm	12 x 12 mm	6 x 6 mm
159/4	60 mm	125 mm	14 x 14 mm	7 x 7 mm
159/5	65 mm	145 mm	16 x 16 mm	8 x 8 mm
159/6	80 mm	165 mm	20 x 20 mm	10 x 10 mm
159/7	95 mm	180 mm	24 x 24 mm	12 x 12 mm
159/9	100 mm	220 mm	30 x 30 mm	15 x 15 mm
159/10	130 mm	280 mm	40 x 40 mm	20 x 20 mm

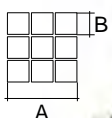

Art.	Ø	H	A	B									
158/B/1	55 mm	130 mm	12 x 12 mm	4 x 4 mm									
158/B/2	60 mm	145 mm	15 x 15 mm	5 x 5 mm									
158/B/3	80 mm	170 mm <td 21 x 21 mm	7 x 7 mm	158/B/4	95 mm	220 mm	24 x 24 mm	8 x 8 mm	158/B/5	95 mm	270 mm	30 x 30 mm	10 x 10 mm
158/B/4	95 mm	220 mm	24 x 24 mm	8 x 8 mm									
158/B/5	95 mm	270 mm	30 x 30 mm	10 x 10 mm									



The baskets were included in our product range in 1981 in response to requests from the emerging German market

Le pigne sono state inserite nella nostra produzione nel 1981 per rispondere alla richiesta dell'emergente mercato tedesco

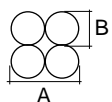
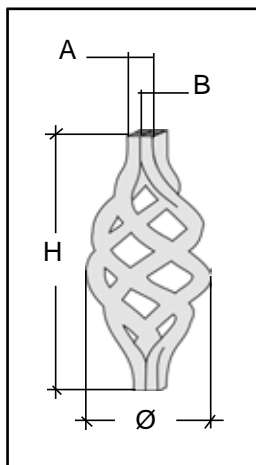

#### BASKETS WITH ROD - PIGNE CON TONDINO

Art.	Ø	H	A	B
1163/1	35 mm	90 mm	8 x 8 mm	Ø 4 mm
1163/2	55 mm	110 mm	10 x 10 mm	Ø 5 mm
1163/3	55 mm	125 mm	12 x 12 mm	Ø 6 mm
1163/4	60 mm	125 mm	14 x 14 mm	Ø 7 mm
1163/5	70 mm	145 mm	16 x 16 mm	Ø 8 mm
1163/6	75 mm	165 mm	20 x 20 mm	Ø 10 mm
1163/7	100 mm	180 mm	24 x 24 mm	Ø 12 mm
1163/8	110 mm	220 mm	30 x 30 mm	Ø 15 mm





Art. 1163/10  
 Ø 70 mm  
 B = 8 x 8 mm



Art. 158/B/7  
 Ø 70 mm  
 B = 6 x 6 mm



Art. 158/B/6  
 Ø 70 mm  
 B = 8 x 8 mm



Art. 1163/12  
 Ø 90 mm  
 B = 6 x 6 mm

Art. 1163/11  
 Ø 115 mm  
 B = 12 x 12 mm

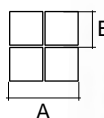

Art. 158/B/8  
 Ø 40 mm  
 H 125 mm  
 A = 12 x 12 mm  
 B = 6 x 6 mm



Art. 1163/9  
 Ø 70 mm  
 B = Ø 6 mm

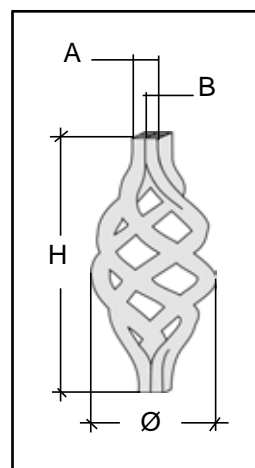

Art. 1164/3  
 Ø 80 mm  
 H 180 mm  
 A = Ø 20 mm  
 B = 10 x 10 mm  
 Hole - Foro Ø 10 mm



Art. 1164/2  
 Ø 70 mm  
 B = 6 x 6 mm  
 Hole - Foro Ø 6 mm

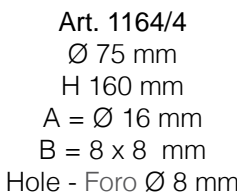

Art. 1164/4  
 Ø 75 mm  
 H 160 mm  
 A = Ø 16 mm  
 B = 8 x 8 mm  
 Hole - Foro Ø 8 mm



Art. 1164/1  
 Ø 90 mm  
 B = 6 x 6 mm  
 Hole - Foro Ø 6 mm

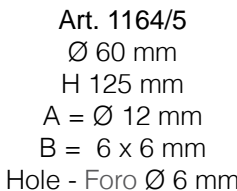

Art. 1164/5  
 Ø 60 mm  
 H 125 mm  
 A = Ø 12 mm  
 B = 6 x 6 mm  
 Hole - Foro Ø 6 mm





The flowers and ornaments made by Arteferro are mainly characterised by floral motifs, threadlike ribs and metallic decorations inspired by nature. They find an application in various contexts and can embellish and enhance the structure they seem to be growing from.

I fiori e gli ornamenti realizzati da Arteferro sono principalmente caratterizzati da motivi floreali, nervature filiformi e decorazioni metalliche si ispirano alla natura. Trovano applicazione in diversi contesti e sono in grado di arricchire e valorizzare il manufatto dal quale sembreranno sbocciare.

**FIORI E ROSETTE**

**FLOWERS AND ROSETTES**

Cast steel  
Ferro fusoArt. 40/B/12  
Ø 48 mm  
Ø 2 mmArt. 1393/6  
Ø 55 mm  
Spess. 8 mmArt. 138/1  
10 mm - Ø 60 mm  
Ø 2 mmArt. 138/2  
Ø 60 mm  
Ø 2 mmArt. 138/15  
Ø 60 mm  
Ø 2 mmArt. 664/1  
Ø 60 mm  
Foro Ø 8 mm  
Ø 3 mmArt. 116/A/4  
Ø 65 mm  
Ø 3 mmArt. 697/4  
Ø 65 mm  
Ø 3 mmArt. 1393/5  
Ø 90 mm  
Spess. 8 mmArt. 660/11  
Ø 90 mm  
Ø 4 mmArt. 660/12  
Ø 90 mm  
Ø 4 mmArt. 697/1  
Ø 90 mm  
Ø 3 mm

Ferro fuso

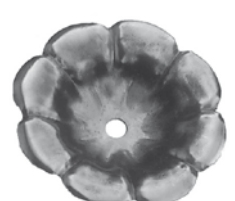
Art. 664/2  
Ø 90 mm  
Foro Ø 16 mm  
Ø 3 mmArt. 116/A/3  
Ø 95 mm  
Ø 3 mmArt. 116/A/5  
Ø 95 mm  
Ø 3 mmArt. 697/3  
Ø 95 mm  
Ø 3 mmArt. 94/B/5  
Ø 105 mm  
Ø 4 mmArt. 711/5  
17 mm - Ø 107 mm  
Ø 0,5 mm

116/A/3+116/A/4 + 41/5

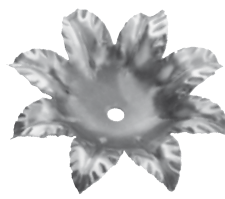
Art. 94/B/6  
Ø 115 mm  
Ø 4 mmArt. 660/10  
Ø 115 mm  
Ø 4 mmArt. 1393/4  
Ø 125 mm  
Spess. 8 mmArt. 705/1  
20 mm - Ø 46 mm  
Thread - Filetto M3  
Ø 0,3 mmArt. 695/4  
Ø 85 mm  
Ø 4 mmArt. 138/4  
10 mm - Ø 90 mm  
Ø 2 mmArt. 701/5  
50 mm - Ø 110 mm  
Ø 0,4 mmArt. 665/1  
Ø 130 mm  
Ø 4 mmArt. 665/2  
Ø 140 mm  
Ø 4 mmArt. 711/3  
Ø 140 mm  
Ø 2 mmArt. 711/6  
28 mm - Ø 150 mm  
Ø 0,3 mmArt. 1328/6  
30 mm - Ø 180 mm  
Ø 4 mm



Art. 705/3  
45 mm - Ø 55 mm  
Thread - Filetto M3  
Ø 0,3 mm



Art. 705/5  
36 mm - Ø 40 mm  
Thread - Filetto M3  
Ø 0,3 mm



Art. 701/6  
40 mm - Ø 65 mm  
Ø 0,3 mm



Art. 700/1  
45 mm - Ø 60 mm  
Ø 1 mm



Art. 700/5  
H 45 mm - Ø 30 mm  
Ø 1 mm



Art. 140/1/3  
68 mm - Ø 60 mm  
Ø 4 mm



Art. 700/10  
Ø 6 mm  
H 320 mm



Art. 700/4  
Ø 5 mm  
H 300 mm



Art. 691/6  
80 x 100 mm  
Ø 12 mm  
Ø 5 mm



Art. 691/7  
80 x 100 mm  
Ø 12 mm  
Ø 5 mm



Art. 140/1/2  
H 110 x L 50 mm  
Ø 4 mm



Art. 666/2  
55 x 90 mm  
Ø 4 mm



Art. 666/5  
45 x 190 mm  
Ø 4 mm



Art. 666/6  
77 x 240 mm  
Ø 4 mm



Art. 750/3  
Ø 35 mm  
H 195 mm



Art. 692/8  
100 x 330 mm  
Ø 4 mm



Art. 666/9  
155 x 390 mm  
Ø 4 mm



Art. 136/3  
70 x 60 mm  
Ø 2,5 mm



Art. 136/4  
70 x 60 mm  
Ø 2,5 mm



Art. 140/F/4  
H 160 x L 70 mm  
Ø 5 mm



Art. 140/F/3  
H 160 x L 70 mm  
Ø 5 mm



Art. 136/1  
110 x 40 mm  
Ø 3 mm  
Art. 136/13  
90 x 30 mm  
Ø 3 mm



Art. 136/2  
110 x 40 mm  
Ø 3 mm  
Art. 136/12  
90 x 30 mm  
Ø 3 mm



Art. 1328/3  
Stem-Gambo  
Ø 6 mm  
H 200 x L 45 mm

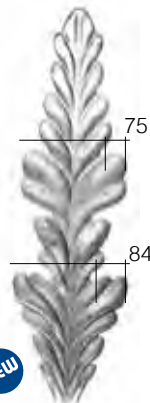

Art. 717/5/S1  
H 285 mm  
Ø 2 mm

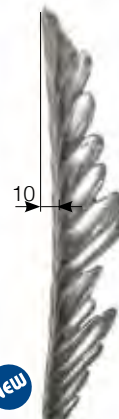

Art. 717/5/S3  
L 25 x H 290 mm  
Ø 2 mm



Art. 717/5/S4  
L 25 x H 285 mm  
Ø 2 mm



Stamped  
Stampata

Art. 751/1  
95 x 185 mm



stem - gambo Ø 12 mm

Art. 94/B/11  
180 x 130 mm  
Ø 4 mm



Art. 94/B/12  
180 x 130 mm  
Ø 4 mm



stem - gambo Ø 12 mm

Art. 94/B/7  
90 x 65 mm  
Ø 4 mm



Art. 94/B/8  
90 x 65 mm  
Ø 4 mm

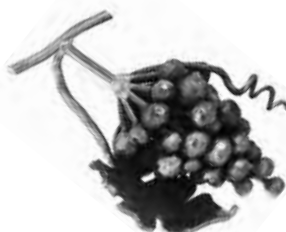

Forged - Forgiato  
Art. 140/H/1  
130 x 270 mm



Forged - Forgiato  
Art. 140/H/2  
90 x 170 mm



Forged - Forgiato  
Art. 673/2  
170 x 90 mm

CAST STEEL - FERRO FUSO



Art. 662/5  
Ø 16 x 6 mm  
150 x 250 mm



Art. 662/6  
Ø 16 x 6 mm  
150 x 250 mm



Art. 662/1  
Ø 16 x 8 mm  
105 x 220 mm



Art. 662/2  
Ø 16 x 8 mm  
105 x 220 mm



Art. 661/1  
Ø 16 x 8 mm  
140 x 155 mm



Art. 661/2  
Ø 16 x 8 mm  
140 x 155 mm



Art. 663/5  
Ø 12 mm  
115 x 180 mm



Art. 663/6  
Ø 12 mm  
115 x 180 mm



Art. 663/1  
Ø 16 x 6 mm  
110 x 140 mm



Art. 663/2  
Ø 16 x 6 mm  
110 x 140 mm



Art. 661/3  
Ø 8 mm  
110 x 155 mm



Art. 661/4  
Ø 8 mm  
75 x 125 mm  
Art. 661/5  
Ø 6 mm  
80 x 125 mm



Art. 664/8  
130 x 250 mm  
Ø 3 mm



Art. 664/7  
50 x 285 mm  
Ø 3 mm



Arteferro manufactures an entire range of wrought iron elements including: meshes, plates, cover plates, mailboxes, letters and numbers, symbols, hinges and weather vanes.

Arteferro realizza molteplici elementi in ferro battuto come ad esempio: maglie, piastre, copri maniglia, cassette postali, lettere e numeri, simboli, cerniere e segnamento.

**DECORI IN LAMIERA**

**DECORATIONS IN STEEL SHEET**



**Art. 852/8**  
spess. 6 mm  
H 70 mm - L 1218 mm

**Art. 852/9**  
thickn.-spess. 2 mm  
H 45 mm - L 1212 mm



**Art. 852/10**  
thickn.-spess. 8 mm  
H 124 mm - L 1206 mm

**Art. 852/11**  
thickn.-spess. 2 mm  
H 45 mm - L 1215 mm



**Art. 852/6**  
thickn.-spess. 6 mm  
H 84 mm - L 1152 mm

**Art. 852/7**  
thickn.-spess. 2 mm  
H 45 mm - L 1213 mm



**Art. 852/12**  
thickn.-spess. 6 mm  
H 70 mm - L 1196 mm

**Art. 852/13**  
thickn.-spess. 2 mm  
H 45 mm - L 1212 mm



**Art. 852/14**  
thickn.-spess. 6 mm  
H 84 mm - L 1160 mm

**Art. 852/15**  
thickn.-spess. 2 mm  
H 45 mm - L 1242 mm

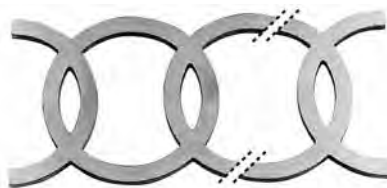

**Art. 852/4**  
thickn.-spess. 8 mm  
H 124 mm - L 1129 mm



**Art. 852/5**  
thickn.-spess. 6 mm  
H 84 mm - L 1140 mm



**Art. 1813/1**  
14 x 6 mm  
H 155 mm  
L 755 mm



**Art. 1813/2** **BEST PRICE**  
14 x 6 mm  
H 155 mm  
L 250 mm



**Art. 1813/6**  
14 x 6 mm  
H 190 mm  
L 960 mm







thickn.-spess. 3 mm - H 55 mm - L 1000 mm  
**Art. 1409/1**  
 plain - liscio



thickn.-spess. 3 mm - H 55 mm - L 990 mm  
**Art. 1410/1**  
 stamped - coniato



thickn.-spess. 3 mm - H 55 mm - L 990 mm  
**Art. 1409/2**  
 plain - liscio



thickn.-spess. 3 mm - H 45 mm - L 990 mm  
**Art. 1410/2**  
 stamped - coniato



thickn.-spess. 3 mm - H 37 mm - L 990 mm  
**Art. 1409/3**  
 plain - liscio



thickn.-spess. 3 mm - H 63 mm - L 960 mm  
**Art. 1410/3**  
 stamped - coniato



thickn.-spess. 3 mm - H 55 mm - L 960 mm  
**Art. 1409/4**  
 plain - liscio



thickn.-spess. 3 mm - H 55 mm - L 993 mm  
**Art. 1410/4**  
 stamped - coniato



**Art. 1411/1**  
 12 x 6 mm - H 165 mm - L 1230 mm



**Art. 1411/2**  
 12 x 6 mm - H 165 mm - L 1160 mm - incl. 30°



**Art. 1411/3**  
 thickn.-spess. 2 mm - H 45 mm - L 1230 mm  
**Art. 1411/4**  
 thickn.-spess. 6 mm - H 84 mm - L 1250 mm



**Art. 1411/5**  
 thickn.-spess. 6 mm - H 84 mm - L 1225 mm  
 incl. 30°

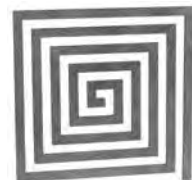

**Art. 1411/6**  
 10 x 5 mm  
 H 200 mm  
 L 200 mm



**Art. 1411/9**  
 thickn.-spess.  
 5 mm  
 Ø 100 mm



12 x 12 mm  
**Art. 1321/1**  
 100 x 100 mm



12 x 12 mm  
**Art. 1321/5**  
 100 x 100 mm



12 x 12 mm  
**Art. 1321/9**  
 100 x 100 mm



**Art. 1411/7**  
 thickn.-spess.  
 5 mm  
 H 100 mm  
 L 100 mm



**Art. 1411/8**  
 thickn.-spess.  
 5 mm  
 H 115 mm  
 L 187 mm



125 x 125 mm  
**Art. 1321/2**  
 125 x 125 mm  
 14 x 14 mm  
**Art. 1321/3**  
 100 x 100 mm  
**Art. 1321/4**  
 125 x 125 mm

125 x 125 mm  
**Art. 1321/6**  
 125 x 125 mm  
 14 x 14 mm  
**Art. 1321/7**  
 100 x 100 mm  
**Art. 1321/8**  
 125 x 125 mm

125 x 125 mm  
**Art. 1321/10**  
 125 x 125 mm  
 14 x 14 mm  
**Art. 1321/11**  
 100 x 100 mm  
**Art. 1321/12**  
 125 x 125 mm



ab 03

Galvanized and painted  
Zincate e verniciate

A E  
O 3

Raw  
Grezze

A  
E

Raw  
Grezze

A  
E

Raw  
Grezze

O 3

Raw  
Grezze

	Stamped Coniato	Stamped Coniato	Plain Liscio	Plain Liscio	Plain Liscio	Plain Liscio
	H 120 mm	H 200 ÷ 250 mm	H 200 ÷ 250 mm	130 x 170 x 6 mm	55 x 80 x 3 mm	40 x 80 mm
	Art.	Art.	Art.	Art.	Art.	Art.
1	171/1	1414/1	1414/12	-	-	*851/1
2	171/2	1414/2	1414/13	-	-	*851/2
3	171/3	1414/3	1414/14	-	-	*851/3
4	171/4	1414/4	1414/15	-	-	*851/4
5	171/5	1414/5	1414/16	-	-	*851/5
6	171/6	1414/6	1414/17	-	-	*851/6
7	171/7	1414/7	1414/18	-	-	*851/7
8	171/8	1414/8	1414/19	-	-	*851/8
9	171/9	1414/9	1414/20	-	-	*851/9
0	171/10	1414/10	1414/21	-	-	*851/10
A	171/11	1412/1	1413/1	850/1	*850/27	-
B	171/12	1412/2	1413/2	850/2	*850/28	-
C	171/13	1412/3	1413/3	850/3	*850/29	-
D	171/14	1412/4	1413/4	850/4	*850/30	-
E	-	1412/5	1413/5	850/5	*850/31	-
F	-	1412/6	1413/6	850/6	*850/32	-
G	-	1412/7	1413/7	850/7	*850/33	-
H	-	1412/8	1413/8	850/8	*850/34	-
I	-	1412/9	1413/9	850/9	*850/35	-
J	-	1412/10	1413/10	850/24	*850/50	-
K	-	1412/11	1413/11	850/10	*850/36	-
L	-	1412/12	1413/12	850/11	*850/37	-
M	-	1412/13	1413/13	850/12	*850/38	-
N	-	1412/14	1413/14	850/13	*850/39	-
O	-	1412/15	1413/15	850/14	*850/40	-
P	-	1412/16	1413/16	850/15	*850/41	-
Q	-	1412/17	1413/17	850/16	*850/42	-
R	-	1412/18	1413/18	850/17	*850/43	-
S	-	1412/19	1413/19	850/18	*850/44	-
T	-	1412/20	1413/20	850/19	*850/45	-
U	-	1412/21	1413/21	850/20	*850/46	-
V	-	1412/22	1413/22	850/21	*850/47	-
W	-	1412/23	1413/23	850/22	*850/48	-
X	-	1412/24	1413/24	850/25	*850/51	-
Y	-	1412/25	1413/25	850/26	*850/52	-
Z	-	1412/26	1413/26	850/23	*850/49	-

\* Letter and number can be matched with the frame of items from no. 851/12 to 851/18

\* Lettera e numero abbinabili alla cornice dall'art. 851/12 all'art.851/18

**FRAMES FOR NUMBERS AND LETTERS - CORNICI PORTA NUMERI E LETTERE**



\* Art. 851/12  
143 x 186 mm  
for one number  
per un numero

\* Art. 851/14  
169 x 302 mm  
up to 5 numbers  
fino a 5 numeri

\* Art. 851/15  
169 x 392 mm  
up to 7 numbers  
fino a 7 numeri



Art. 851/11  
80 x 40 mm



\* Art. 851/16  
145 x 193 mm  
up to 3 numbers  
fino a 3 numeri

\* Art. 851/17  
145 x 273 mm  
up to 5 numbers  
fino a 5 numeri

\* Art. 851/18  
151 x 353 mm  
up to 7 numbers  
fino a 7 numeri

example - esempio



Art. 852/1  
∅ 12 mm  
H 290 mm  
L 230 mm



Art. 852/2  
∅ 12 mm  
H 240 mm  
L 180 mm



Art. 1412/27  
stamped  
coniato  
Art. 1413/27  
plain - liscio



H 220 x L 170 mm

Art. 1412/28  
stamped  
coniato  
Art. 1413/28  
plain - liscio



Art. 1414/22  
plain - liscio

H 315 x L 245 mm

H 250 x L 250 mm



Art. 199/1  
∅ 3 mm  
25 x 25 mm



Art. 199/2  
∅ 3 mm  
120 x 120 mm



Art. 199/3  
∅ 3 mm  
60 x 160 mm



Art. 199/4  
∅ 3 mm  
60 x 160 mm



Art. 199/5  
∅ 3 mm  
120 x 160 mm



Art. 199/6  
∅ 3 mm  
150 x 230 mm



Art. 199/12  
collars for  
fasciette per



Art. 199/7  
∅ 3 mm  
30 x 70 mm



Art. 199/8  
∅ 3 mm  
80 x 70 mm



Art. 199/10  
collars  
fascette



Art. 199/11  
∅ 3 mm  
45 x 25 mm



Art. 199/13  
∅ 3 mm  
40 x 105 mm



Art. 199/14  
∅ 3 mm  
40 x 105 mm



Art. 199/9  
collars  
fascette



Art. 199/15  
∅ 3 mm  
80 x 105 mm



Art. 199/16  
∅ 3 mm  
75 x 230 mm



Art. 199/17  
∅ 3 mm  
75 x 230 mm



# MARKETING SUPPORT ASSISTENZA MARKETING

Our marketing department is available to organise promotional activities and develop customised advertising materials bearing the customer's logo. We have many years' experience in producing custom leaflets and catalogues for our most loyal customers.

Il nostro ufficio marketing è a disposizione per organizzare attività ed elaborare materiale promozionale personalizzato con il logo del cliente. Da anni ormai realizziamo volantini e cataloghi ad hoc per i nostri clienti più affezionati.

**+39 0445 580 580**

from Monday to Friday  
dal Lunedì al Venerdì  
**08.00 -18.00 (GMT+1)**

**info@arteferro.com**

**www.arteferro.com**

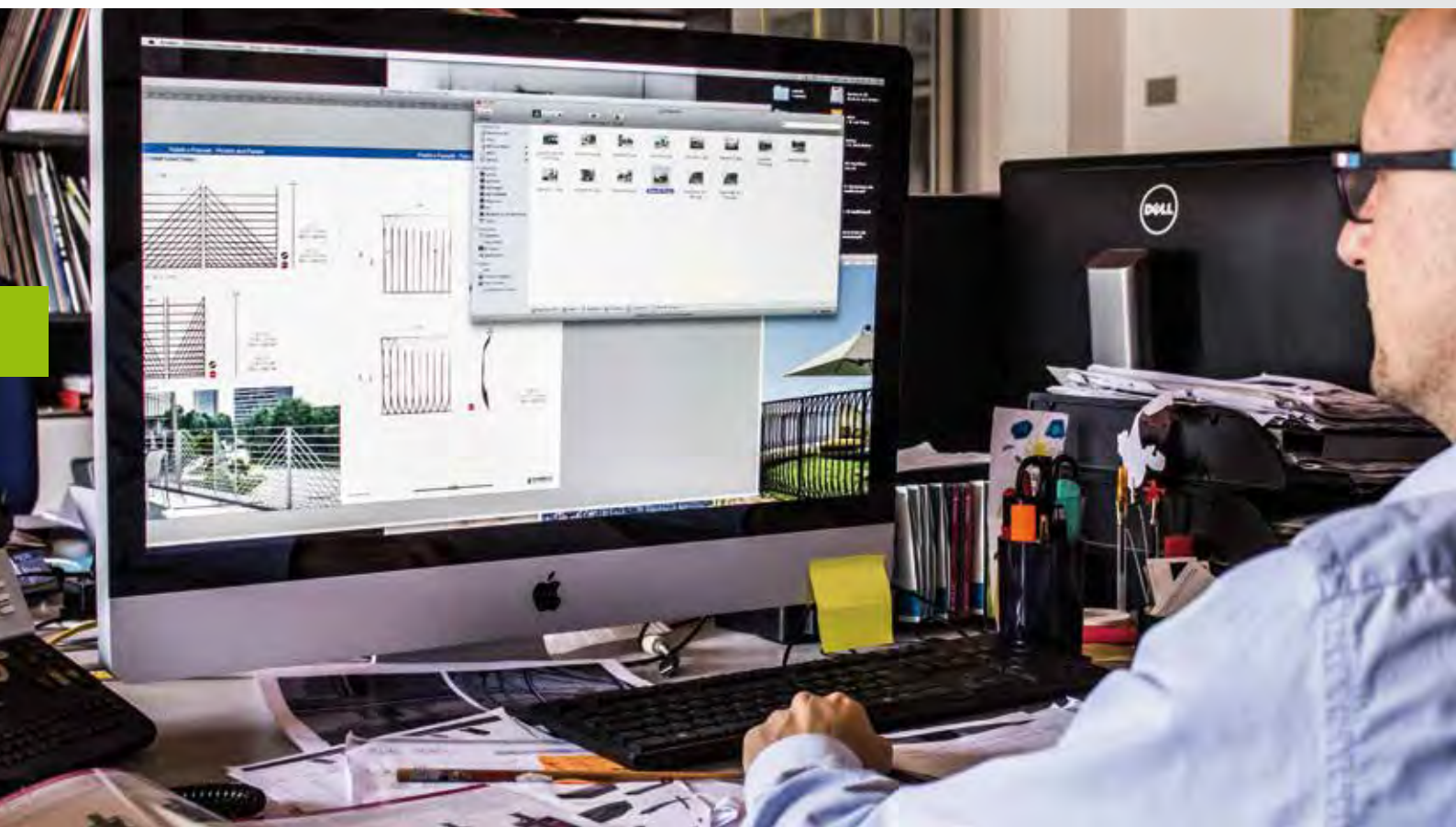



Arteferro plates are decorative elements that can either be positioned at the base or alongside posts, and can be manufactured with a rounded or square shape, depending on the client's aesthetic requirements. Arteferro accessories are mainly complementary elements and have no structural function, such as: handles, knobs, hinges and locks.

Le piastre Arteferro sono elementi decorativi poste o alla base o a lato dei montanti e possono essere realizzate di forma tonda o quadrata a seconda delle esigenze estetiche della committenza. Gli accessori Arteferro invece sono principalmente elementi di complemento e non hanno funzione strutturale, quali: maniglie, pomolini, cardini e serrature.

# PIASTRE ED ACCESSORI PLATES AND ACCESSORIES

17

Plates and Accessories  
Piastre ed Accessori



17.A Anchor plates Piastre di ancoraggio .....pag.244  
 17.B Rivets Ribattini ..... pag.248  
 17.C Chains Catene ..... pag.249  
 17.D Door handles Maniglie .....pag.250

17.E Locks covers Copriserratura ..... pag.253  
 17.F Locks Serrature ..... pag.254  
 17.G Hinges Cardini ..... pag.255  
 17.H Paints and varnishes Patine e Vernici ..... pag.257  
 17.I Weathervanes and Mail boxes Segnavento e Casette postali ..... pag.258

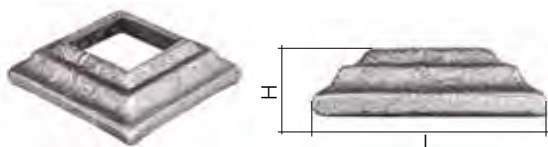

L/H	Hole - Foro	Art.
L 40 x 40 mm H 17 mm	without hole - senza foro	819/11
	for - per $\varnothing$ 12 x 12 mm	819/8
	for - per $\varnothing$ 14 x 14 mm	819/7
	for - per $\varnothing$ 16 x 16 mm	819/6
L 50 x 50 mm H 19 mm	without hole - senza foro	819/10
	for - per $\varnothing$ 16 x 16 mm	819/5
	for - per $\varnothing$ 18 x 18 mm	819/4
	for - per $\varnothing$ 20 x 20 mm	819/3
L 60 x 60 mm H 19 mm	without hole - senza foro	819/9
	for - per $\varnothing$ 25 x 25 mm	819/2
	for - per $\varnothing$ 30 x 30 mm	819/1
L 80 x 80 mm H 22 mm	without hole - senza foro	819/17
	for - per $\varnothing$ 25 x 25 mm	819/18
	for - per $\varnothing$ 30 x 30 mm	819/15
	for - per $\varnothing$ 40 x 40 mm	819/16

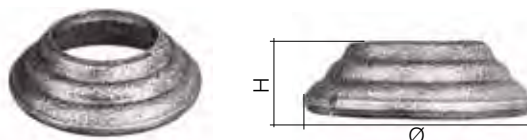

Ø/H	Hole - Foro	Art.
Ø 30 mm H 17 mm	without hole - senza foro	1408/18
	per Ø 12 mm	1408/21
Ø 40 mm H 18,5 mm	without hole - senza foro	1408/17
	for - per Ø 12 mm	1408/5
	for - per Ø 14 mm	1408/19
Ø 50 mm H 18 mm	for - per Ø 16 mm	1408/20
	without hole - senza foro	1408/16
	for - per Ø 16 mm	1408/13
Ø 50 mm H 18 mm	for - per Ø 18 mm	1408/12
	for - per Ø 20 mm	1408/11
	without hole - senza foro	1408/15
Ø 60 mm H 18 mm	for - per Ø 25 mm	1408/7
	for - per Ø 30 mm	1408/6
	without hole - senza foro	1408/14
Ø 80 mm H 19 mm	for - per Ø 30 mm	1408/10
	for - per Ø 35 mm	1408/9
	for - per Ø 40 mm	1408/8

ROUNDED BASES  
BASI BOMBATE



Art. 1860/1 Ø 580 mm H 45 mm ∇ 6 mm	Art. 1860/4 Ø 360 mm H 31,5 mm ∇ 3 mm	Art. 1860/6 Ø 414 mm H 44 mm ∇ 4 mm
Art. 1860/2 Ø 680 mm H 50 mm ∇ 8 mm	Art. 1860/5 Ø 415 mm H 33 mm ∇ 4 mm	
Art. 1860/3 Ø 780 mm H 55 mm ∇ 8 mm		

BORDERED FLAT BASES  
BASI PIANE BORDATE



Art.	Ø	H	Thickness Spessore
1861/1	170 mm	20 mm	3 mm
1861/2	200 mm	25 mm	4 mm
1861/3	220 mm	32 mm	4 mm
1861/4	240 mm	25 mm	6 mm
1861/5	260 mm	28 mm	6 mm
1861/6	290 mm	31 mm	6 mm
1861/7	320 mm	32 mm	6 mm
1861/8	370 mm	38 mm	5 mm
1861/9	500 mm	28 mm	5 mm

LENS BASES  
BASI ALENTE



Art.	Ø	H	Thickness Spessore
1861/10	120 mm	13 mm	3 mm
1861/11	140 mm	13 mm	3 mm
1861/12	160 mm	16 mm	4 mm
1861/13	185 mm	21 mm	3 mm
1861/14	195 mm	20 mm	4 mm
1861/16/S	275 mm	30 mm	6 mm
1861/17	295 mm	40 mm	6 mm
1861/18	340 mm	35 mm	6 mm
1861/19	380 mm	35 mm	6 mm
1861/20	480 mm	40 mm	6 mm

BORDERED SQUARE BASES  
BASI QUADRATE BORDATE



Art.	Side Lato	H	Thickness Spessore
1861/21	143 mm	14 mm	6 mm
1861/22	200 mm	19 mm	6 mm

## Anchor plates - Piastre di ancoraggio

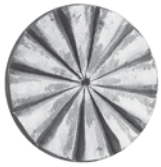

Art. 654/5  
 Ø 60 mm  
 ▧ 6 mm



Art. 1393/7  
 Ø 68 mm  
 hole - foro  
 Ø 12,5 mm  
 ▧ 10 mm



Art. 1857/13  
 Ø 82 mm  
 ▧ 4 mm



Art. 1857/14  
 Ø 82 mm  
 hole - foro  
 Ø 8,5 mm  
 ▧ 4 mm



Art. 1857/15  
 Ø 82 mm  
 hole - foro  
 Ø 15 mm ▧ 4 mm  
 H 10 mm



Art. 660/11  
 Ø 90 mm  
 ▧ 4 mm



Art. 660/12  
 Ø 90 mm  
 ▧ 4 mm



Art. 660/10  
 Ø 115 mm  
 ▧ 4 mm

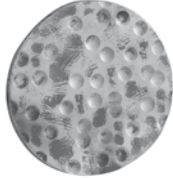

Art. 1408/3  
 Ø 160 mm  
 ▧ 10 mm



Art. 116/A/1  
 70 x 70 mm  
 Hole - Foro  
 ⌀ 13 x 13 mm  
 ▧ 5 mm



Art. 802/5  
 70 x 70 mm  
 ▧ 6 mm



Art. 116/A/2  
 75 x 75 mm  
 hole - foro  
 ⌀ 13 x 13 mm  
 ▧ 5 mm



Art. 1408/1  
 80 x 80 mm  
 hole - foro  
 ⌀ 26 x 26 mm  
 H 18 mm



Art. 116/A/6  
 100 x 100 mm  
 without hole  
 senza foro  
 ▧ 10 mm



Art. 116/A/7  
 100 x 100 mm  
 hole - foro  
 ⌀ 30 x 30 mm  
 ▧ 10 mm



Art. 1857/5  
 100 x 100 mm  
 ▧ 8 mm  
 Art. 1857/6  
 120 x 120 mm  
 ▧ 8 mm



Art. 1857/7  
 100 x 100 mm  
 ▧ 8 mm  
 Art. 1857/8  
 120 x 120 mm  
 ▧ 8 mm



Art. 802/4  
 100 x 100 mm  
 ▧ 10 mm



Art. 181/6  
 120 x 120 mm  
 ▧ 8 mm

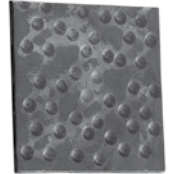

Art. 1408/4  
 160 x 160 mm  
 ▧ 10 mm



Art. NEW0049  
 ▧ 6 mm  
 H 280 mm  
 L 130 mm  
 Art. NEW0050  
 ▧ 6 mm  
 H 220 mm  
 L 100 mm



Art. NEW0054  
 Base 35 mm  
 ▧ 6 mm  
 H 140 mm  
 L 130 mm  
 Art. NEW0055  
 Base 32 mm  
 ▧ 6 mm  
 H 110 mm  
 L 100 mm



Art. 94/A/7  
 H 165 mm  
 L 100 mm  
 Art. 94/A/8  
 H 150 mm  
 L 85 mm



Art. 1470/9  
 H 220 mm  
 L 75 mm  
 ▧ 3 mm



Art. 1470/8  
 H 300 mm  
 L 75 mm  
 ▧ 3 mm  
 Art. 841/7  
 H 520 mm  
 L 75 mm  
 ▧ 3 mm

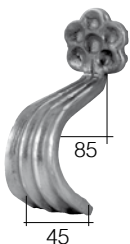

Art. 1857/2  
 ▧ 8 mm

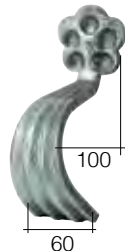

Art. 1857/4  
 ▧ 8 mm

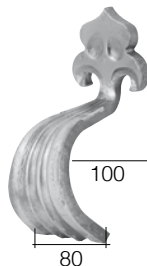

Art. 1857/3  
 ▧ 8 mm



NEW0051  
 ▧ 8 mm  
 80 x 235 mm

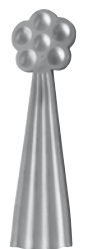

NEW0052  
 ▧ 8 mm  
 65 x 220 mm



- Art. F060  
Ø 33 x 4 mm
- Art. F061  
Ø 42 x 4 mm
- Art. F062  
Ø 48 x 4 mm
- Art. F063  
Ø 60 x 4 mm
- Art. F0631  
Ø 70 x 6 mm
- Art. F064  
Ø 80 x 4 mm
- Art. F065  
Ø 100 x 4 mm
- Art. F066  
Ø 100 x 6 mm
- Art. F069  
Ø 120 x 6 mm



- Art. F06910  
Ø 70 x 6 mm
- Art. F06911  
Ø 80 x 6 mm
- Art. F06912  
Ø 100 x 8 mm
- Art. F06913  
Ø 120 x 8 mm

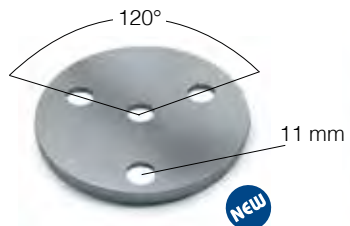

- Art. F06920  
Ø 70 x 6 mm
- Art. F06921  
Ø 80 x 6 mm
- Art. F06922  
Ø 100 x 8 mm
- Art. F06923  
Ø 120 x 8 mm



- Art. F0681  
Ø 80 x 6 mm
- Art. F0682  
Ø 100 x 6 mm



- Art. F0181  
Ø 62 mm  
H 15 mm



- Art. F085700  
30 x 50 mm  
∇ 5 mm

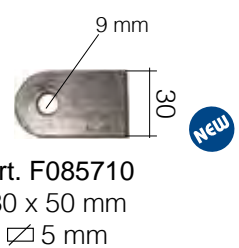

- Art. F085710  
30 x 50 mm  
∇ 5 mm

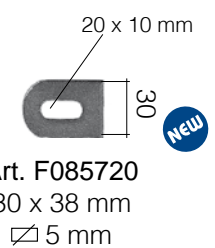

- Art. F085720  
30 x 38 mm  
∇ 5 mm



- Art. F083500  
50 x 100 mm  
∇ 8 mm



- Art. F083510  
60 x 120 mm  
∇ 8 mm



- Art. F083520  
80 x 120 mm  
∇ 8 mm



- Art. F083600  
50 x 100 mm  
∇ 8 mm

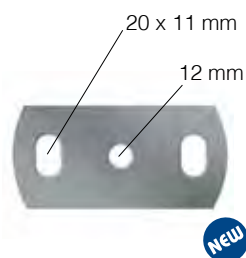

- Art. F083610  
60 x 120 mm  
∇ 8 mm

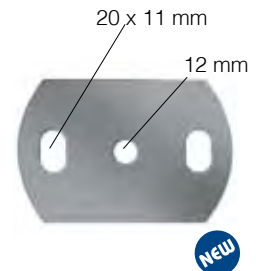

- Art. F083620  
120 x 80 mm  
∇ 8 mm



- Art. F085500  
100 x 100 mm  
∇ 6 mm

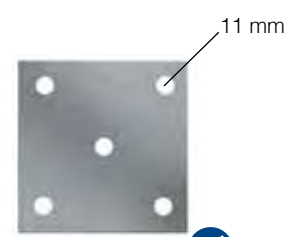

- Art. F085600  
100 x 100 mm  
∇ 6 mm



- Art. F085510  
120 x 120 mm  
∇ 8 mm

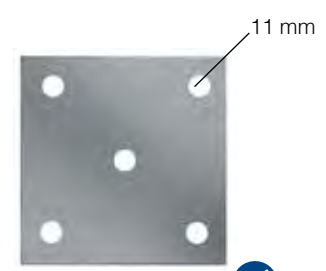

- Art. F085610  
120 x 120 mm  
∇ 8 mm





Art. F0222

NEW

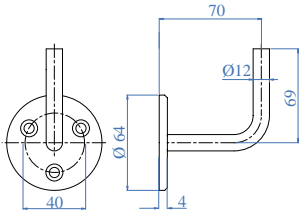

Art. F02231

NEW

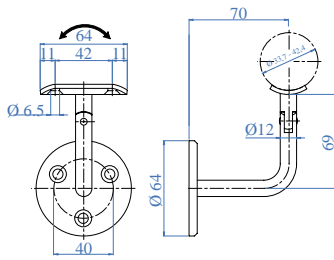

Art. F0223

NEW

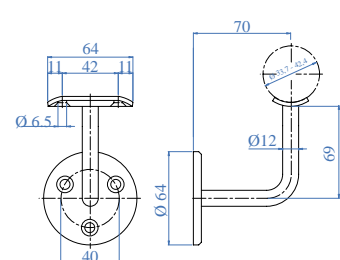

NEW

Art. F01197  
25 x 64 mm  
for tube - per tubo  
Ø 33,7 - Ø 42,4 mm  
∩ 4 mm



NEW

Art. F011976  
25 x 64 mm  
flat surf. - sup. piana  
∩ 4 mm



NEW

Art. F011974  
for tube - per tubo  
Ø 33,7 - Ø 42,4 mm  
∩ 4 mm



NEW

Art. F011971  
for tube - per tubo  
Ø 33,7 - Ø 42,4 mm  
∩ 4 mm

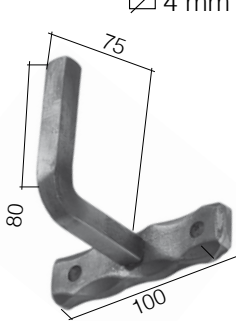

Art. 1405/1  
Base 25 x 8 mm  
holes-foi Ø 8,5 mm  
∩ 12 x 12 mm

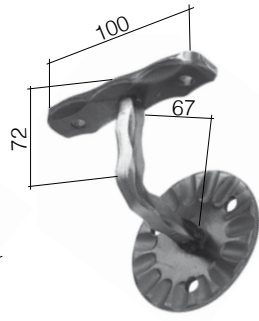

Art. 1405/2  
Base Ø 80 x 4 mm  
holes-foi Ø 8,5 mm  
∩ 12 x 12 mm

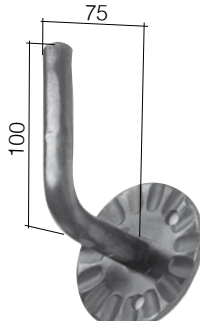

Art. 1405/3  
Base Ø 80 x 4 mm  
holes-foi Ø 8,5 mm  
Ø 16 mm



Art. 94/A/1  
90 x 160 mm



Art. 94/A/2  
90 x 160 mm



Art. 116/33  
16 x 16 mm  
H 110 mm  
L 150 mm  
lathed-tornito Ø 14 mm

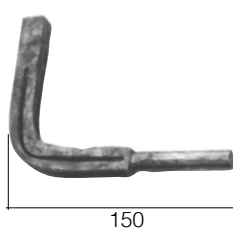

Art. 116/34  
16 x 16 mm  
H 110 mm  
L 150 mm  
lathed-tornito Ø 14 mm



Art. 116/35  
Ø 65 mm  
∩ 8 mm  
hole - foro Ø 15 mm

Rivets - Ribattini

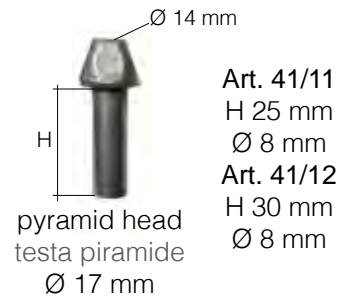
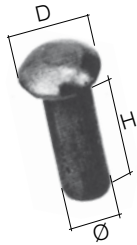

Art.	Ø	H	D
41/17	6 mm	20 mm	11 mm
41/18	6 mm	25 mm	11 mm
41/19	6 mm	30 mm	11 mm
41/20	6 mm	35 mm	11 mm
41/21	6 mm	40 mm	11 mm
41/22	6 mm	45 mm	11 mm
41/23	6 mm	50 mm	11 mm
41/24	6 mm	60 mm	11 mm
41/13	7 mm	25 mm	11 mm
41/14	8 mm	8 mm	16 mm
41/15	8 mm	20 mm	16 mm
41/1	8 mm	25 mm	16 mm
41/4	8 mm	30 mm	16 mm
41/5	8 mm	35 mm	16 mm
41/6	8 mm	40 mm	16 mm
41/16	8 mm	45 mm	16 mm
41/7	8 mm	50 mm	16 mm
41/8	8 mm	60 mm	16 mm

ORNAMENTAL RIVETS  
CHIODI ORNAMENTALI



STUDS  
BROCCHIE DI COPERTURA



These items appeared scenes of the film "Sangue Del Tuo Sangue" (2015) by Marco Bellocchio, which was shown at the 72nd Venice International Film Festival.

Questi articoli compaiono nelle scene del film Sangue del tuo sangue (2015) di Marco Bellocchio, presentato alla 72° Mostra Internazionale del Cinema di Venezia.



FORGED RIVETS  
CHIODI FORGIATI



Art.	Head Testa	Shank Sotto testa $\square$	H
1474/6	30 mm	14 x 14 mm	L 285 mm
1474/7	30 mm	12 x 12 mm	L 210 mm
1474/8	25 mm	10 x 10 mm	L 160 mm
1474/9	20 mm	8 x 8 mm	L 105 mm
1474/10	13 mm	5 x 5 mm	L 70 mm

RIVET HEADS TO BE WELDED  
TESTE DI RIBATTINI TORNITE A SALDARE



SELF-TAPPING SCREWS - VITI AUTOFILETTANTI  
forged head - testa forgiata



Art.	Head Testa $\square$	Thread MA Filetto MA	H
695/6	30 x 30 mm	10 mm	90 mm
695/7	22 x 22 mm	8 mm	75 mm
695/8	16 x 16 mm	8 mm	62 mm

Art.	Head Testa	Thread MA Filetto MA	H
695/9	Ø 35 mm	10 mm	90 mm
695/10	Ø 24 mm	8 mm	85 mm
695/11	Ø 18 mm	8 mm	62 mm

Art.	Diameter Diametro	Hole Foro
697/5	Ø 16 mm	Ø 8 mm
697/7	Ø 12 mm	Ø 6 mm
697/8	Ø 12 mm	Ø 5 mm

Length of the chains  
Lunghezza delle catene  
= 10.000 mm (10 mt.)



Not all of the Arterferro items are available in **Arterferro Quick**, just a special selection. Find out about the entire range in the catalogue

In **Arterferro Quick** non sono presenti tutti gli articoli Arterferro, ma solo una speciale selezione. Scopri la gamma completa nel catalogo

*Compendium*



Art. 156/A/7  
5 x 5 mm

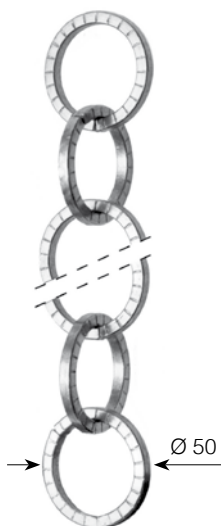

Art. 156/A/8  
5 x 5 mm



Art. 156/A/10  
5 x 5 mm



Art. 156/A/11  
3,5 x 3,5 mm

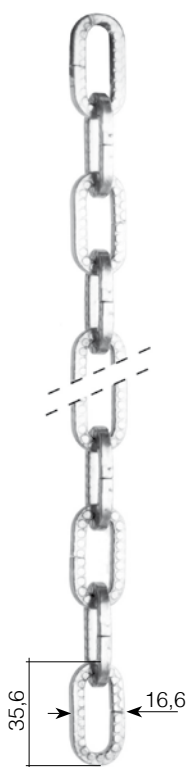

Art. 156/A/12  
3,8 x 3,8 mm





Art. 168/4  
250 x 38 mm  
(couple-coppia)



Art. 168/6  
250 x 56 mm  
(couple-coppia)



Art. 168/5  
265 x 48 mm  
(couple-coppia)



Art. 168/3  
265 x 48 mm  
(couple-coppia)



Art. 833/4  
280 x 60 mm  
(couple-coppia)



Art. 836/1  
250 x 50 mm  
(couple-coppia)



Art. 831/1  
255 x 55 mm  
(couple-coppia)



Art. 169/12  
70 x 135 mm  
(couple-coppia)



Art. 835/6  
Rosetta Ø 30 mm  
(couple-coppia)



Art. 169/13  
80 x 140 mm  
(couple-coppia)



Art. 835/8  
90 x 50 mm  
(couple-coppia)



Art. 835/7  
90 x 50 mm  
(couple-coppia)



Art. 835/9  
100 x 40 mm  
(couple-coppia)



Art. 169/15  
40 x 110 mm  
(couple-coppia)

handle complete with rosette  
maniglia completa di rosetta



Art. 169/14 **BEST PRICE**  
70 x 135 mm  
(couple-coppia)

handle complete with rosette  
maniglia completa di rosetta



Art. 169/11  
70 x 125 mm  
(couple-coppia)

handle complete with rosette  
maniglia completa di rosetta

## TOPS - POMOLI

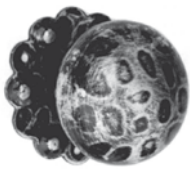

Art. 169/1  
Ø 68 mm  
rotating-girevole  
(couple-coppia)

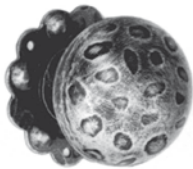

Art. 169/2  
Ø 60 mm  
fixed-fisso



Art. 169/3  
Ø 60 mm  
rotating-girevole  
(couple-coppia)



Art. 834/1  
Ø 67 mm  
H 75 mm  
rotating-girevole  
(couple-coppia)



Art. 838/1  
57 x 57 mm  
H 70 mm  
rotating-girevole  
(couple-coppia)  
Art. 838/2  
57 x 57 mm  
H 70 mm  
fixed-fisso

## TOPS - POMOLI



Art. 838/3  
60 x 60 mm  
H 45 mm  
fixed-fisso



Art. 838/4  
75 x 75 mm  
H 60 mm  
fixed-fisso



Art. 1474/5  
Ø 70 mm  
Ø 8MA  
thread hole-foro filetto



Even today, most of the accessories are produced manually just like they were in 1971

Ancora oggi la gran parte degli accessori vengono prodotti manualmente come nel 1971



Art. 833/3  
77 x 35 mm  
(couple-coppia)



Art. 833/2  
Ø 53 mm  
(couple-coppia)

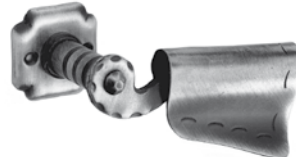

Art. 833/1  
58 x 58 mm  
(couple-coppia)



Art. 1475/7  
37 x 75 mm  
Plain-Liscio



Art. 833/6  
240 x 260 mm  
(couple-coppia)



Art. 834/3  
265 x 80 mm  
(couple-coppia)



Art. 836/4  
275 x 60 mm  
rotating-girevole

**MECHANISM GRAZ FOR CREMONESI HANDLES  
GIOCHI GRAZ PER CREMONESI**

Art. 835/1  
200 x 40 mm  
built-in - incasso



Art. 835/2  
160 x 55 mm  
built-in - incasso



Art. 835/3  
150 x 45 mm  
built-in - incasso



Art. 835/4  
140 x 33 mm  
backed - ridosso



Art. 835/5  
190 x 35 mm  
built-in - incasso

**KNOBS - BATTENTI**

Art. 837/2  
Ø 150 mm  
rosette - rosetta  
Ø 80 mm



Art. 1474/4  
Ø 120 mm  
base Ø 90 mm



Art. 1474/4  
Ø 110 mm  
rosette - rosetta  
Ø 95 mm



Art. 170/A/5  
49 x 43 mm



Art. 170/7  
170 x 105 mm



Art. 837/3  
Ø 100 mm  
rosette - rosetta  
Ø 60 mm

**FIXED HANDLES - MANIGLIONI FISSI**

Art. 839/3  
480 x 80 mm  
□ 18 mm



Art. 1474/3  
315 x 40 mm



Art. 839/4  
250 x 70 mm  
□ 18 mm



Art. 170/6  
310 x 60 mm



Art. 839/1  
H 300 mm  
Ø 32 mm  
rosette - rosetta  
Ø 80 mm



Art. 1474/2  
H 340 mm  
rosette - rosettes  
Ø 90 mm



Art. 1474/1  
270 x 55 mm

Art. 839/2  
H 200 mm  
Ø 25 mm  
rosette - rosetta  
Ø 60 mm





Art. 170/A/10  
49 x 43 mm



Art. 170/A/6  
90 x 33 mm



Art. 170/A/4  
90 x 38 mm



Art. 170/A/8  
58 x 27 mm



Art. 170/A/11  
58 x 27 mm



Art. 170/A/1  
31 x 121 mm



Art. 170/A/7  
48 x 48 mm



Art. 170/A/9  
48 x 48 mm



Art. 834/2  
Ø 67 mm



Art. 170/1  
Ø 65 mm



Art. 170/2  
Ø 65 mm



Art. 170/3  
Ø 50 mm



Art. 170/5  
Ø 50 mm



Art. 839/5  
85 x 35 mm  
∇ 2 mm



Art. 839/6  
85 x 35 mm  
∇ 2 mm



Art. 839/7  
85 x 35 mm  
spess. 2 mm  
hole-foro Ø 14 mm



Art. 839/8  
70 x 35 mm  
∇ 2 mm



Art. 839/9  
100 x 40 mm  
∇ 2 mm



Art. 839/10  
100 x 40 mm  
spess. 2 mm  
hole-foro Ø 14 mm



Art. 169/6  
250 x 56 mm

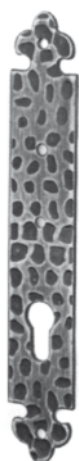

Art. 169/7  
250 x 38 mm



Art. 169/8  
265 x 48 mm



Art. 169/9  
265 x 48 mm



Art. 169/10  
250 x 38 mm



Art. 169/4  
40 x 250 mm



Art. 169/5

Locks - Serrature

Art. 181/10  
285 x 105 mm  
☒ 30 mm

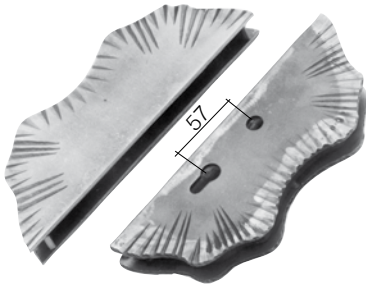

Art. 181/11  
285 x 105 mm  
☒ 30 mm

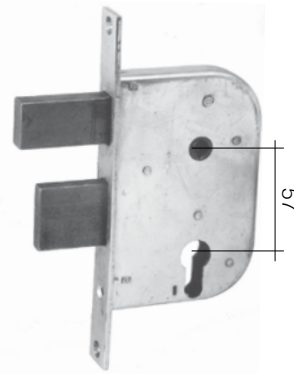

Art. 181/12  
Double-lock latch  
Serratura doppia mandata

YALE LOCKS  
BLOCCHETTI YALE



Art. 181/15

BOLTS - CATENACCI



Art. 170/B/1  
45 x 190 mm



Art. 170/B/2  
30 x 150 mm



Art. 170/B/3  
30 x 105 mm

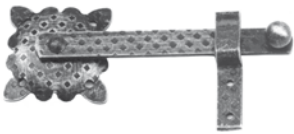

Art. 170/B/5  
81 x 137 mm



Art. 840/4  
30 x 160 mm



Art. 840/5  
30 x 200 mm



Art. 840/6  
50 x 150 mm



Art. 840/1  
65 x 300 mm



Art. 840/2  
65 x 350 mm



Art. 840/3  
65 x 400 mm



Art. 182/1  
60 x 100 mm



Art. 182/2  
60 x 280 mm





Hinges - Cardini

power hammered  
magliato

plain  
liscio

power hammered  
magliato



Art. 170/B/4  
Ø 14 mm  
H 100 mm  
thread - filetto  
8MA mm



Art. 830/1  
Ø 22 mm  
H 100 mm  
thread - filetto  
14MA mm



Art. 830/2  
Ø 22 mm  
H 100 mm  
thread - filetto  
14MA mm



Art. 181/13  
Ø 38 mm  
H 230 mm  
thread - filetto  
22MA mm  
Art. 181/14  
Ø 32 mm  
H 175 mm  
thread - filetto  
18MA mm

Welding hinge  
Cardine a saldare



Art. 164/1  
thread - filetto  
18MA mm  
Art. 164/2  
thread - filetto  
22MA  
Art. 830/17  
thread - filetto  
27MA mm

Wall hinge  
Cardine a muro



Art. 164/3  
thread - filetto  
18MA mm  
Art. 164/4  
thread - filetto  
22MA  
Art. 830/18  
thread - filetto  
27MA mm

Hinge with orthogonal regulation  
opening of up to 180°  
Cardine a regolazione ortogonale  
con apertura fino a 180°

Art. 830/19  
thread - filetto  
18MA mm  
Art. 830/20  
thread - filetto  
22MA mm  
Art. 830/21  
thread - filetto  
27MA mm

Passing hinge  
Cardine passante



Art. 830/3  
thread - filetto  
20MA mm



Art. 164/5  
thread - filetto  
18MA mm  
Art. 164/6  
thread - filetto  
22MA mm

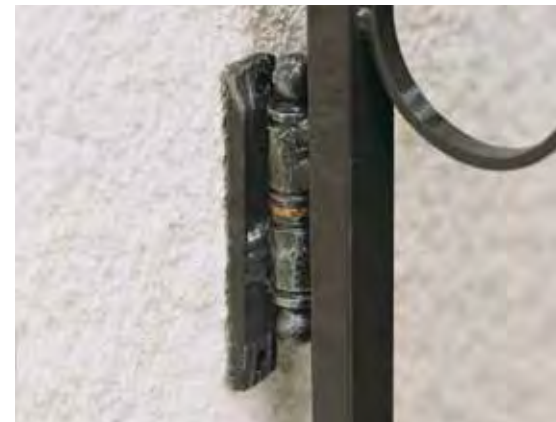

Art. 830/7  
H 89 mm - Ø 28 mm

Art. 830/9  
H 89 mm - Ø 23 mm

Art. 830/10  
H 89 mm - Ø 28 mm

Pivot  
Perno



With hinge  
Con cardine  
18MA  
Art. 164/7  
to be coupled with  
da abbinare con  
art. 164/9

With hinge  
Con cardine  
22MA  
Art. 164/8  
to be coupled with  
da abbinare con  
art. 164/10

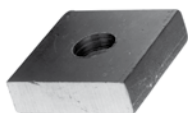

Art. 830/13  
H 20 mm - L 80 mm

Art. 830/15  
H 20 mm - L 70 mm

Art. 830/16  
H 20 mm - L 80 mm

Plate  
Piastra

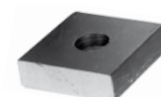

With hinge  
Con cardine  
18MA  
Art. 164/9  
With hinge  
Con cardine  
22MA  
Art. 164/10

**LATCHES/LIGHT HINGES FOR FURNITURE  
CATENACCI/CERNIERE LEGGERI PER MOBILI**



Art. 837/4  
H 145 mm  
60 x 2 mm



Art. 837/5  
H 260 mm  
55 x 2 mm



Art. 837/7  
H 95 mm  
70 x 2 mm



Art. 837/9  
H 145 mm  
110 x 2 mm



Art. 837/8  
H 100 mm  
70 x 2 mm



Art. 837/10  
H 160 mm  
120 x 2 mm



Art. 170/A/3  
92 x 55 x 2 mm



Art. 170/A/2  
68 x 125 x 2 mm



Arteferro supplies paints and patinas for finishing your wrought ironwork, both indoors and outdoors. They can be used to colour handrails, stairs, gates, bars, fences and other decorative elements in forged iron.

Arteferro mette a disposizione vernici e patine per rifinire al meglio le vostre realizzazioni in ferro battuto, sia in interni che in esterni. Possono essere utilizzate per la colorazione di corrimani, scale, cancelli, inferriate, recinzioni ed altri elementi decorativi in ferro forgiato.

## Varnishes - Vernici

Arteferro paints, available either as transparent varnishes or coloured paints, provide a finishing and at the same time prevent the natural deterioration of metal caused by atmospheric agents. To obtain better and longer lasting results, we recommend you to "prepare" the iron using other Arteferro products such as nitro thinner or an iron brush.

Le vernici Arteferro, disponibili sia trasparenti che colorate, rifiniscono e al contempo prevengono il naturale deterioramento del metallo dovuto agli agenti atmosferici. Per ottenere risultati migliori e duraturi consigliamo di "preparare" il ferro utilizzando gli altri prodotti Arteferro come il diluente nitro o la spazzola per ferro.

## Patinas - Patine

Arteferro patinas are special paints, very opaque and dense, which allow an elegant oxidation effect to be produced on the metal, thus giving the painted product a refined style with a thick decorative finish. Available in gold, copper, silver and green, they can be applied after painting as well as directly onto the iron.

Le patine Arteferro sono vernici particolari, molto coprenti e dense, che consentono di riprodurre un elegante effetto ossidazione sul metallo, conferendo così al prodotto verniciato uno stile ricercato di grande spessore decorativo. Disponibili in colore oro, rame, argento e verde possono essere applicate dopo la verniciatura ma anche direttamente sul ferro.



Wrought Iron Black  
Nero forgia  
Art. 227/1 Lt. 0,75  
Art. 227/2 Lt. 2,50



Graphite gray  
Grafite  
Art. 227/3 Lt. 0,75  
Art. 227/4 Lt. 2,50



Dark brown  
Testa di moro  
Art. 227/35 Lt. 0,75  
Art. 227/36 Lt. 2,50



Rust colour coating  
Ruggine trasparente  
Art. 227/53 Lt. 0,75  
Art. 227/54 Lt. 2,50



Black gray  
Grigio nero  
Art. 227/45 Lt. 0,75  
Art. 227/20 Lt. 2,50



Dark gray  
Grigio scuro  
Art. 227/46 Lt. 0,75  
Art. 227/22 Lt. 2,50



Bronze  
Bronzo  
Art. 227/47 Lt. 0,75  
Art. 227/24 Lt. 2,50



English red  
Rosso inglese  
Art. 227/39 Lt. 0,75  
Art. 227/40 Lt. 2,50



Dark green  
Verde scuro  
Art. 227/55 Lt. 0,75  
Art. 227/56 Lt. 2,50



Antique white  
Bianco antico  
Art. 227/33 Lt. 0,75  
Art. 227/34 Lt. 2,50



Pearl grey  
Grigio perla  
Art. 227/41 Lt. 0,75  
Art. 227/42 Lt. 2,50



Art. 227/43  
Silver gray  
Grigio argento  
Art. 227/43 Lt. 0,75  
Art. 227/16 Lt. 2,50



Light chiaro  
Grigio chiaro  
Art. 227/44 Lt. 0,75  
Art. 227/18 Lt. 2,50



Green wagon  
Verde vagone  
Art. 227/37 Lt. 0,75  
Art. 227/38 Lt. 2,50



Gold patina  
Patina oro  
Art. 227/29 Lt. 0,25



Copper patina  
Patina rame  
Art. 227/30 Lt. 0,25



Green patina  
Patina verde  
Art. 227/31 Lt. 0,25



Silver patina  
Patina argento  
Art. 227/32 Lt. 0,25



Thinner  
Diluente sintetico  
Art. 227/27 Lt. 1,00  
Art. 227/28 Lt. 5,00



Pale gold patina  
Patina oro pallido  
Art. 227/51 Lt. 0,25



Antique gold patina  
Patina oro antico  
Art. 227/52 Lt. 0,25



Verdigris mat patina  
Patina verde rame opaco  
Art. 227/30 Lt. 0,25

Nitre thinner  
Diluente Nitro  
Art. 227/57 Lt. 1,00  
Art. 227/58 Lt. 5,00

Weathervanes and Mail boxes - Segnavento e Cassette postali



Art. 10314/1  
762 x 762 mm



Art. 10314/2  
698 x 965 mm



Art. 10314/3  
482 x 673 mm



Art. 10314/4  
546 x 546 mm



Art. 10315/1  
635 x 508 mm



Art. 10315/2  
635 x 546 mm



Art. 10315/3  
685 x 698 mm

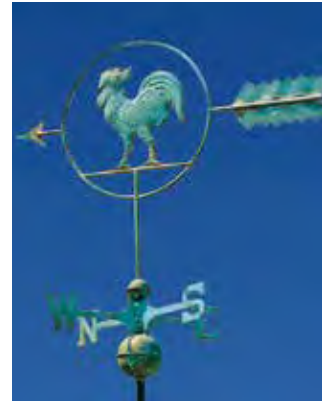

Art. 10316/1  
787 x 571 mm



Art. 10315/6  
558 x 520 mm



Art. 10301/2  
H 455 mm - L 400 mm  
P 155 mm  
cast iron  
ghisa



Art. 5069/3  
H 1100 mm  
Base 330 x 240 mm  
cast iron - ghisa



Art. 10301/1  
H 405 mm - L 255 mm  
P 90 mm  
cast iron - ghisa



Art. 849/1  
Aluminium - White colour  
Alluminio - Colore bianco

Art. 849/2  
Aluminium - Black colour  
Alluminio - Colore bianco

Art. 849/3  
Aluminium - Red colour  
Alluminio - Colore rosso

Art. 849/4  
Aluminium - Green colour  
Alluminio - Colore verde





TOOLS

UTENSILI

The fabrication tools include all blacksmith's accessories, such as: anvils, hammers, shapers, templates, forging pliers and much more. With the right tools, installation becomes easier, faster and safer. Arteferro has chosen to make available to its customers a range of tools dedicated to the correct assembly of its semi-finished products.

Gli strumenti fabbrili comprendono tutta l'accessoristica per fabbri quali: incudini, martelli, sagomatori, dime, pinze da forgiatore e molto altro ancora. Con i giusti strumenti l'installazione diventa più facile, più veloce e più sicura. Arteferro ha scelto di mettere a disposizione dei propri clienti una gamma di strumenti dedicati al corretto montaggio dei suoi semilavorati.

Art. 869/1  
150 kg



Art. 869/2  
H 500 mm  
Ø 500 mm

Art. 870/1  
50 kg



Art. 870/2  
H 580 mm  
Ø 350 mm

Art. 870/3  
100 kg



Art. 870/4  
H 530 mm  
Ø 400 mm

### ANVIL ENGRAVERS AND SHAPERS - INCISORI E SAGOMATORI PER INCUDINE



Art.	Ø
872/1	5 mm
872/2	10 mm
872/3	20 mm
872/4	25 mm
872/5	30 mm



Art.	Ø
872/6	5 mm
872/7	10 mm
872/8	15 mm
872/9	20 mm
872/10	25 mm
872/11	30 mm



Art. 873/1  
Flat shaping engraver  
Sagomatore piano



Art. 873/2  
Notched engraver  
Incisore a tacche



Art. 873/3  
Conic engraver  
Incisore puntale



Art. 871/1  
H 840 mm  
L 350 mm  
Calibrating template  
Dima calibratrice



SHAPED CHISELS  
SCALPELLI SAGOMATORI

Art.	Ø
876/1	5 mm
876/2	10 mm
876/3	20 mm
876/4	25 mm
876/5	30 mm

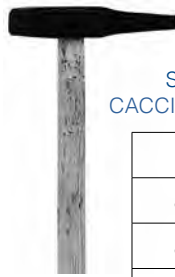

SQUARE HEAD WEDGE  
CACCIA CUNEO A PUNTA QUADRA

Art.	□
877/1	10 mm
877/2	15 mm
877/3	20 mm
877/4	25 mm



ROUND HEAD WEDGE  
CACCIA CUNEO A PUNTA TONDA

Art.	Ø
877/5	10 mm
877/6	15 mm
877/7	20 mm
877/8	25 mm

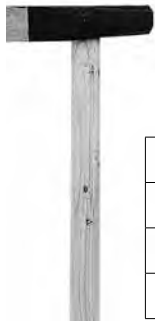

KNIFE CHISELS  
SCALPELLI A COLTELLO

Art.	Peso
875/7	1,0 Kg
875/8	1,5 Kg
875/9	2,0 Kg

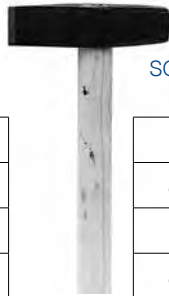

SQUARE HEAD WEDGE CHISELS  
SCALPELLI INCISORI

Art.	Peso
875/10	1,0 Kg
875/11	1,5 Kg
875/12	2,0 Kg



SHAPED CHISELS  
SCALPELLI SAGOMATORI

Art.	Ø
876/6	5 mm
876/7	10 mm
876/8	15 mm
876/9	20 mm
876/10	25 mm
876/11	30 mm

FLAT SHAPING CHISELS  
SCALPELLI SAGOMATORI PIANI



Art. 874/4  
70 x 70 mm



Art. 874/5  
50 x 50 mm



Art. 874/1  
1,5 kg



Art. 874/2  
1,5 kg



Art. 874/3  
2,0 kg

SLEDGEHAMMERS  
MAZZETTE

### SLEDGEHAMMERS - MAZZE



Art. 875/1  
3,0 kg



Art. 875/2  
4,0 kg



Art. 875/3  
5,0 kg



Art. 875/4  
6,0 kg



Art. 875/5  
8,0 kg



Art. 875/6  
10,0 kg

### HOT STAMPED BLACKSMITH'S TONGS TENAGLIE STAMPATE L 500 mm

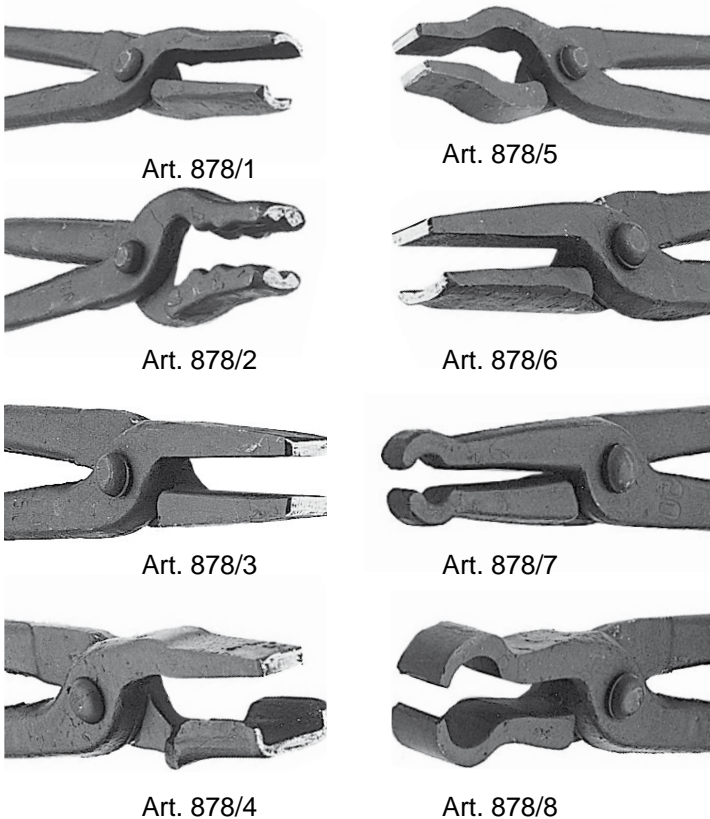

Art. 878/1

Art. 878/5

Art. 878/2

Art. 878/6

Art. 878/3

Art. 878/7

Art. 878/4

Art. 878/8

### FORGING TOOLS TENAGLIE FORGIATE L 450 mm

Art. 879/2



Art. 879/3

### SINGLE OVEN - FORNO SINGOLO

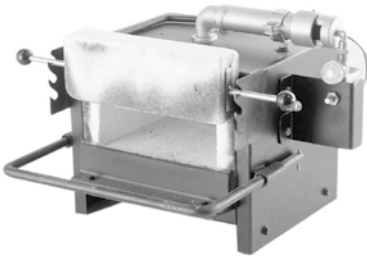

Art. 1559/1

External measures - Misure esterne  
L 310 mm - H 255 mm - P 255 mm  
Internal measures - Misure interne  
L 200 mm - H 250 mm - P 90 mm

### SMALL FORGE" TRANSPORTABLE BY HAND

#### MAIN FEATURES:

- Maximum Temperature 1300°C
- Easy ignition
- Safety device, in case of any sudden or accidental malfunction
- Opening on two sides (front / back) to insert long bars
- The combustion chamber is isolated with ceramicfiber panels made of refractory material
- The front screen with its adjustable opening, allow for energy saving and guarantees the maximum security

### DOUBLE OVEN - FORNO DOPPIO

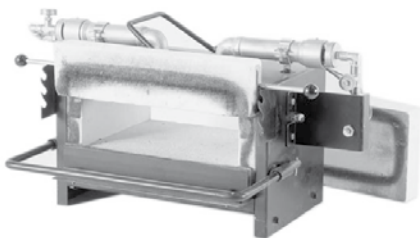

Art. 1559/2

External measures - Misure esterne  
L 410 mm - H 255 mm - P 255 mm  
Internal measures - Misure interne  
L 300 mm - H 250 mm - P 90 mm

### PICCOLA "FORGIA" TRASPORTABILE A MANO

#### CARATTERISTICHE PRINCIPALI:

- Temperatura massima 1300 °C
- Accensione facilitata
- Dispositivo di sicurezza in caso di spegnimento accidentale
- Forno a passaggio totale (avanti / dietro) per l'inserimento anche di verghe lunghe
- La camera di combustione è isolata con pannelli in fibroceramica e base in refrattario
- Lo schermo a chiusura regolabile permette un risparmio di energia e garantisce la massima sicurezza



The ovens fulfill  
the current international  
guidelines of security, in  
accordance with the  
EC rules

I forni rispondono  
alle vigenti direttive  
internazionali di  
sicurezza, in conformità  
alla normativa CE



## WORKING GLOVES - GUANTI DA LAVORO



Swine skin  
Crosta di Maiale  
Art. 880/1



Swine skin  
Crosta di Maiale  
Art. 880/2



Cotton and latex  
Cotone e Lattice  
Art. 880/3



Welding gloves-long  
Lungo per la saldatura  
Art. 880/4



Welding gloves-short  
Corto per la saldatura  
Art. 880/5

CUT-OFF WHEELS  
DISCHI DA TAGLIO

Art. 881/1  
Ø 115 mm  
3,40 x 22 mm  
Art. 881/2  
Ø 230 mm  
3,40 x 22 mm  
Art. 881/3  
Ø 300 mm  
3,00 x 22 mm  
fix/fissi

GRINDING WHEELS  
DISCHI SMERIGLIO

Art. 881/4  
Ø 115 mm  
6,00 x 22 mm  
Art. 881/5  
Ø 230 mm  
6,00 x 22 mm

LAMINATED WHEELS  
DISCHI LAMELLARI

Art. 881/6  
Ø 115 x 22 mm  
grain-grana 40  
Art. 881/7  
Ø 230 x 22 mm  
grain-grana 60  
Art. 881/8  
Ø 115 x 22 mm  
grain-grana 80  
Art. 881/9  
Ø 115 x 22 mm  
grain-grana 120



## WELDING ELECTRODES - ELETTRODI PER SALDATURA



Art.	* 882/1	* 882/2	* 882/3
Measurements Misure	Ø 2,5 mm L 300 mm	Ø 3,25 mm L 350 mm	Ø 3,25 mm L 400 mm
Boxes per pallet - Scatole sul bancale	240	234	160
* Pieces in each box - Pezzi in ogni scatola	290	180	157
Weight per pallet - Peso per bancale	1200 kg	1200 kg	1200 kg

LIQUID ZINC SPRAY  
ZINCO LIQUIDO SPRAY  
400 ml



Art. 185/9

ANTI SOLDER  
WELDING SPRAY  
ANTI SPRUZZO DI  
SALDATURA  
400 ml



Art. 883/1

UNLOCKING SPRAY  
SPRAY SBLOCCANTE  
400 ml



Art. 883/3

CHEMICAL ANCHOR  
(adaptable silicone piston)  
ANCORANTE CHIMICO  
(adattabili su pistone per silicone)



Art. 883/4

**STAIR MEASUREMENT SYSTEM  
SISTEMA MISURAZIONE SCALE**

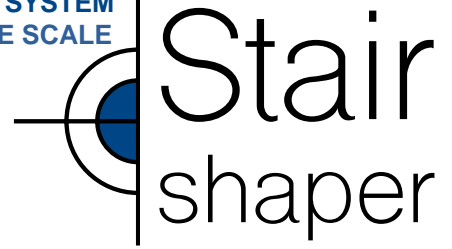

Art. 882/40

Kit with 2 boxes  
Total 72 pieces  
galvanized  
Kit di 2 casse  
Totale 72 pezzi  
zincati a freddo

Arteferro also supplies Stair Shaper a special system that allows you to measure stairs, even with an irregular form, and to reconstruct the profile at a 1: 1 scale in your workshop. In this way you can work on sizing the staircase easily with all your tools and only need to go back to the construction site for the final installation.

Arteferro fornisce anche Stair Shaper, uno speciale sistema che consente di misurare una scala, anche a sviluppo irregolare, e ricostruirne il profilo in rapporto 1:1 nella propria officina. Potrai quindi comodamente lavorare al dimensionamento della scala con tutti i tuoi attrezzi e recarti nuovamente in cantiere solo per l'installazione finale.

**The advantages of the system are:**

- it's easy to use
- you can work in the comfort of your workshop
- the time spent on the construction site is reduced
- you can save up to 10 hours of labour for every railing

**I vantaggi del sistema:**

- facile da usare
- lavori nella comodità della tua officina
- riduci il tempo passato in cantiere
- risparmi fino a 10 ore di manodopera per ogni ringhiera

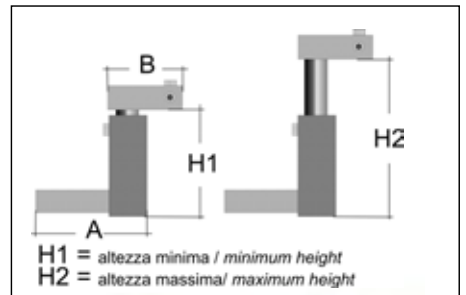
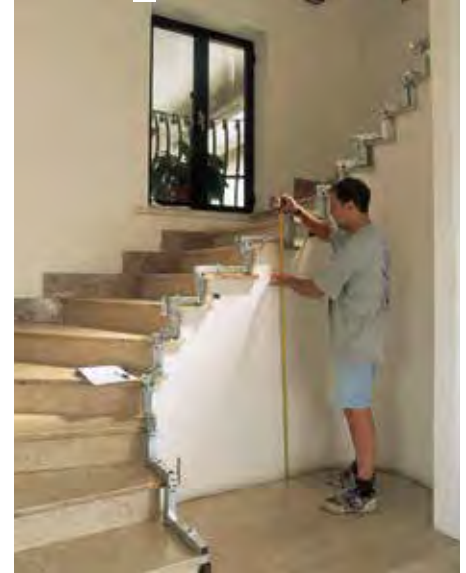
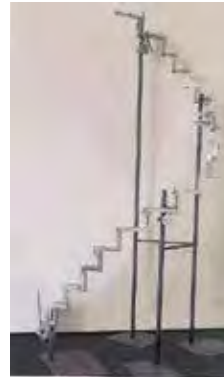

**RAISING COMPONENTS OF STEPS - COMPONENTI DI ALZATA**

Art. 1905/1	Art. 1905/2	Art. 1905/3	Art. 1905/4	Art. 1905/5	Art. 1905/6	Art. 1905/7
A = 120 mm	A = 120 mm	A = 210 mm	A = 90 mm	A = 150 mm	A = 90 mm	A = 90 mm
B = 55 mm	B = 85 mm	B = 155 mm	B = 55 mm	B = 85 mm	B = 55 mm	B = 55 mm
H1 = 160 mm	H1 = 160 mm	H1 = 160 mm	H1 = 160 mm	H1 = 160 mm	H1 = 160 mm	H1 = 310 mm
H2 = 235 mm	H2 = 235 mm	H2 = 235 mm	H2 = 235 mm	H2 = 235 mm	H2 = 235 mm	H2 = 500 mm

**TREAD COMPONENTS OF STEPS - COMPONENTI DI PROFONDITÀ PEDATE**

Art. 1905/8	Art. 1905/9	Art. 1905/10	Art. 1905/12	Art. 1905/13
L 200 mm	L 150 mm	L 100 mm	L 80 mm	L 50 mm

**ELABORATION / SUPPORT / SLIDING COMPONENTS - COMPONENTI DI SVILUPPO/APPOGGIO/SCORRIMENTO**

Art. 1905/14	Art. 1905/15	Art. 1905/16	Art. 1905/17	Art. 1905/18	Art. 1905/19
		hole-foro 35 x 35 mm H 100 mm flange-flangia Ø 140 mm	hole-foro 35 x 35 mm	hole-foro 35 x 35 mm	

Not all of the Arterferro items are available in **Arterferro Quick**, just a special selection.

Find out about the entire range in the catalogue

In **Arterferro Quick** non sono presenti tutti gli articoli Arterferro, ma solo una speciale selezione.

Scopri la gamma completa nel catalogo

*Compendium*

INDEX - INDICE

16/1	187	41/20	248	46/5	159	49/2	111	64/H/20	84	78/B/5	203
16/2	187	41/21	248	46/6	159	49/3	97	64/H/9/S	84	78/B/6	203
16/3	186	41/22	248	46/10	159	49/4	110	64/H/10/S	84	80/A/1	199
17/1	186	41/23	248	46/11	159	50/5	89	65/8	94	80/A/1/S8	199
17/2	186	41/24	248	46/12	159	50/6	89	70/D/2	94	80/A/2	199
18/1	186	42/1	44	47/3	153	50/7	89	70/D/3	94	80/A/3	199
18/2	186	42/2	44	47/3/1000	153	50/8	89	70/D/4	155	80/A/4	199
18/3	187	42/3	44	47/4	160	50/9	89	70/D/5	155	80/A/5	199
18/4	187	42/4	44	47/5	153	50/10	89	70/D/9	155	80/A/6	199
18/A/1	186	42/5	44	47/6	153	50/11	89	70/E/8	111	80/A/7	199
20/5	186	42/6	44	47/9	153	50/12	89	73/1	208	80/A/8	199
20/6	186	42/7	44	47/10	160	50/13	89	73/2	208	80/A/9	198
21/4	186	42/8	45	47/11	153	50/14	89	73/3	208	80/B/3	198
21/5	187	42/9	45	47/12	153	50/15	89	74/1	198	80/B/8	198
22/3	187	42/10	45	47/13	153	50/16	89	74/2	198	80/C/7	199
22/A/2	186	42/11	45	47/14	153	51/3	111	74/3	198	80/C/8	199
23/1	186	42/12	45	47/15	153	52/1	106	74/4	198	80/C/9	199
23/2	186	42/13	45	47/16	153	52/2	97	74/5	198	80/A/10	198
23/3	186	42/14	45	47/17	153	52/A/2	97	74/6	198	80/A/11	198
24/1	187	42/15	45	47/18	153	52/A/3	97	74/7	198	80/A/12	198
24/2	187	42/16	45	47/19	153	52/A/4	109	74/8	198	80/A/13	199
24/3	188	42/17	45	47/20	153	52/A/5	97	74/9	198	80/A/14	199
24/B/1	188	42/18	45	47/22	153	52/E/1	109	74/10	198	80/A/15	199
24/C/2	187	42/19	45	47/23	153	52/E/2	110	74/11	198	80/A/16	199
24/F/1	105	42/20	45	47/24	153	52/G/1	106	74/12	198	80/A/17	198
26/1	186	42/21	45	47/25	153	53/2	111	74/13	198	80/A/18	198
26/2	186	42/22	45	47/26	153	53/3	94	74/14	198	80/A/19	198
26/C/1	189	42/23	45	47/27	153	58/3	110	74/15	198	80/A/20	198
30/4	186	42/24	45	47/28	153	59/1	110	74/16	198	80/A/21	199
30/7	186	42/25	45	47/29	153	62/1	105	74/17	198	80/A/22	199
33/2	186	42/26	45	47/30	153	62/2	105	74/18	198	80/A/23	199
33/3	186	42/27	45	47/31	153	63/4	105	74/19	198	80/A/24	198
35/1	215	42/28	45	47/32	153	64/A/3	96	74/20	198	80/A/25	198
35/2	215	42/A/1	44	47/33	153	64/A/7	96	74/21	198	80/A/26	198
37/3	215	42/A/2	44	47/34	153	64/B/2	96	74/22	198	80/A/27	198
38/1	59	42/A/3	44	47/35	153	64/B/5	96	74/23	198	80/A/28	199
38/2	59	42/A/4	44	47/36	153	64/D/1	160	74/24	198	80/A/29	199
38/3	59	42/A/5	45	48/1	102	64/D/3	157	74/25	198	80/A/30	199
38/4	59	42/A/6	45	48/2	102	64/D/4	157	74/26	198	80/A/31	198
40/1	59	42/A/7	45	48/3	102	64/D/5	157	74/27	198	80/A/32	198
40/2	59	42/A/8	45	48/4	102	64/D/6	157	74/28	198	80/C/10	199
40/3	59	42/A/9	45	48/6	102	64/D/7	157	75/31	209	80/C/11	199
40/4	59	42/B/5	163	48/7	102	64/D/8	157	75/32	209	80/C/13	199
40/5	59	42/B/6	163	48/8	102	64/D/9	157	75/33	209	80/C/14	199
40/A/1	59	42/B/7	163	48/9	102	64/E/1	96	76/1	208	80/C/17	199
40/A/2	59	42/B/8	163	48/11	102	64/E/2	96	76/2	208	80/C/18	199
40/A/3	59	42/A/10	45	48/12	102	64/E/3	96	76/3	208	80/C/19	199
40/B/10	58	42/A/11	45	48/13	102	64/F/1	84	78/1	198	80/C/20	199
40/B/12	234	42/A/12	45	48/14	102	64/F/2	84	78/2	198	80/C/21	199
40/A/1/S	59	42/A/13	45	48/A/1	102	64/F/3	84	78/3	198	80/C/23	199
40/B/10/S1	58	42/A/14	45	48/A/2	102	64/F/4	84	78/4	198	80/C/24	199
41/1	248	42/A/15	45	48/A/3	102	64/F/5	84	78/5	198	81/1	206
41/4	248	42/A/16	45	48/A/4	102	64/F/6	84	78/6	198	81/3	206
41/5	248	42/A/17	45	48/A/5	102	64/F/7	84	78/7	198	81/5	206
41/6	248	42/A/18	45	48/A/7	102	64/F/8	84	78/8	198	81/7	206
41/7	248	42/A/15/S	45	48/A/8	102	64/F/9	84	78/9	198	82/3	206
41/8	248	42/B/4/S16	55	48/A/9	102	64/G/1	84	78/10	198	82/5	206
41/10	248	42/B/4/S17	55	48/B/1	103	64/G/2	84	78/11	198	84/1	206
41/11	248	42/A/16/SP3	45	48/B/2	103	64/G/3	204	78/12	198	84/2	206
41/12	248	44/11	160	48/B/3	103	64/G/4	204	78/13	198	84/5	206
41/13	248	44/12	160	48/B/4	103	64/G/5	204	78/14	198	84/6	206
41/14	248	44/13	160	48/B/5	103	64/G/6	204	78/15	205	84/7	206
41/15	248	45/19	160	48/B/6	103	64/H/9	84	78/16	205	84/8	206
41/16	248	45/20	160	48/B/7	103	64/I/1	91	78/B/1	203	85/8	39
41/17	248	45/22	160	48/B/8	103	64/D/10	157	78/B/2	203	85/9	39
41/18	248	46/3	159	48/A/11	102	64/H/10	84	78/B/3	203	86/5	203
41/19	248	46/4	159	48/A/12	102	64/H/19	84	78/B/4	203	87/1	203

Not all of the Arterferro items are available in **Arterferro Quick**, just a special selection.

Find out about the entire range in the catalogue

In **Arterferro Quick** non sono presenti tutti gli articoli Arterferro, ma solo una speciale selezione.

Scopri la gamma completa nel catalogo

*Compendium*

INDEX - INDICE

87/3	206	94/P/2	200	114/6	34	116/13	34	116/F/18	218	118/C/2	163
87/4	206	94/P/3	200	114/7	34	116/14	32	116/F/19	218	118/C/3	163
87/5	203	94/P/4	200	114/8	34	116/15	34	116/10/S1	32	118/C/4	163
87/6	203	94/P/9	200	114/9	22	116/16	34	116/10/S3	32	118/C/5	163
88/1	208	94/Q/1	200	114/10	32	116/25	34	116/10/S7	32	118/C/6	163
88/2	208	94/Q/2	200	114/11	34	116/26	33	116/10/XL	32	118/C/7	163
88/3	208	94/Q/3	200	114/12	34	116/27	34	116/11/XL	34	118/C/8	163
88/4	208	94/Q/4	200	114/13	32	116/28	34	116/36/S1	32	118/C/9	163
88/5	208	94/Q/5	200	114/14	32	116/29	34	116/37/S1	32	118/E/1	24
88/6	208	94/Q/6	200	114/A/1	28	116/30	33	117/1	218	118/E/2	24
88/10	203	94/Q/7	200	114/A/2	28	116/31	34	117/2	218	118/E/3	24
88/A/3	203	94/Q/8	200	114/A/3	26	116/32	34	117/3	218	118/E/4	24
88/H/2	198	94/B/11	236	114/A/5	35	116/33	247	117/4	218	118/E/5	24
88/H/3	198	94/B/12	236	114/A/6	35	116/34	247	117/5	218	118/E/6	24
88/H/4	198	94/C/10	214	114/B/1	28	116/35	247	117/6	218	118/E/7	24
88/I/2	200	94/C/11	214	114/B/2	28	116/36	32	117/7	218	118/E/8	24
88/I/3	200	94/C/12	214	114/B/3	31	116/37	32	117/8	218	118/E/9	24
88/L/3	200	94/C/13	214	114/B/4	34	116/39	33	117/9	218	118/F/1	37
88/L/4	200	94/C/14	214	114/B/5	32	116/6/S	32	117/10	37	118/F/2	37
88/N/1	206	94/P/10	200	114/B/6	34	116/A/1	245	117/11	37	118/F/3	37
88/N/2	206	94/P/11	200	114/B/7	34	116/A/2	245	117/12	37	118/F/4	37
88/N/3	205	94/P/12	200	114/B/8	34	116/A/3	234	117/13	37	118/F/5	37
88/N/4	206	97/2	110	114/B/9	32	116/A/4	234	117/14	37	118/F/6	37
88/N/5	206	98/1	76	114/10/S	32	116/A/5	234	117/15	218	118/F/7	34
88/N/6	205	99/1/C	76	114/9/S2	22	116/A/6	245	117/16	218	118/F/8	34
88/N/7	206	99/2/C	76	114/B/10	34	116/A/7	245	117/1/L	218	118/F/9	34
88/P/1	203	102/4	110	114/B/11	34	116/A/8	34	118/1	20	118/H/1	94
88/P/2	203	104/3	77	114/B/12	32	116/A/9	33	118/2	20	118/H/2	94
88/P/3	203	104/4	77	114/B/13	26	116/D/1	69	118/3	20	118/H/3	94
92/B/3	213	105/3	78	114/B/14	26	116/D/2	69	118/4	20	118/H/4	94
92/B/4	213	105/1/C	78	114/B/15	26	116/E/1	70	118/5	20	118/H/5	36
92/C/3	213	105/2/C	78	114/B/5/S	32	116/E/2	70	118/6	20	118/H/6	36
93/1	213	105/5/C	78	114/4/6000	34	116/E/3	70	118/7	22	118/H/7	36
93/2	213	109/3	76	114/5/6000	32	116/E/4	70	118/8	22	118/H/8	36
93/3	213	110/3	77	114/6/6000	34	116/E/6	69	118/10	23	118/H/9	36
93/4	213	112/3	95	114/7/6000	34	116/F/1	218	118/11	23	118/15/S	21
94/1	213	112/4	95	114/8/6000	34	116/F/2	218	118/12	23	118/23/S	21
94/2	213	112/5	76	114/9/35X8	22	116/F/3	218	118/13	23	118/24/S	20
94/3	213	112/6	76	114/9/6000	22	116/F/4	218	118/14	23	118/7/S1	22
94/A/1	247	112/7	77	114/B/5/S3	32	116/F/5	218	118/15	21	118/8/S1	22
94/A/2	247	112/8	77	114/B13/S9	26	116/F/6	218	118/16	21	118/9/S1	22
94/A/7	245	112/9	77	114/10/6000	32	116/F/7	218	118/17	21	118/A/10	19
94/A/8	245	112/11	75	114/11/6000	34	116/F/8	218	118/18	21	118/A/11	19
94/B/5	234	112/B/9	104	114/12/6000	34	116/F/9	218	118/19	21	118/A/12	19
94/B/6	234	112/B/10	104	114/13/6000	32	116/14/S	32	118/20	21	118/A/13	19
94/B/7	236	112/B/11	104	114/14/6000	32	116/2/S1	32	118/21	21	118/A/14	19
94/B/8	236	112/B/12	104	114/A/3/6000	26	116/2/S2	32	118/22	21	118/A/15	19
94/C/1	214	112/B/13	104	114/A/5/6000	35	116/A/10	34	118/23	21	118/A/16	19
94/C/2	214	112/B/14	104	114/A/6/6000	35	116/A/11	34	118/24	20	118/C/10	163
94/C/3	214	112/B/15	104	114/9/35X8/6000	22	116/A/12	34	118/25	20	118/C/11	163
94/C/4	214	112/B/16	104	115/1	31	116/A/14	34	118/26	23	118/C/12	163
94/C/5	214	113/1	104	115/2	31	116/A/15	34	118/27	23	118/C/13	163
94/C/6	214	113/2	104	115/3	31	116/A/16	33	118/28	23	118/C/14	163
94/C/9	214	113/3	104	115/4	31	116/A/17	182	118/29	23	118/C/15	163
94/E/1	214	113/4	104	115/5	31	116/A/18	182	118/29/6000	23	118/C/16	163
94/E/2	214	113/5	89	116/1	34	116/A/19	182	118/30	23	118/C/17	163
94/E/3	214	113/6	89	116/2	32	116/A/20	182	118/7/S	22	118/C/18	163
94/E/4	214	113/7	95	116/3	34	116/A/21	182	118/A/1	20	118/C/19	163
94/E/5	214	113/8	95	116/4	34	116/A/22	182	118/A/2	20	118/C/20	163
94/E/6	214	113/9	182	116/5	34	116/F/10	218	118/A/3	20	118/C/21	163
94/F/1	214	113/10	182	116/6	32	116/F/11	218	118/A/4	20	118/C/22	163
94/F/2	214	113/11	218	116/7	34	116/F/12	218	118/A/5	20	118/C/23	163
94/F/3	214	113/12	218	116/8	34	116/F/13	218	118/A/5	65	118/C/24	163
94/F/4	214	114/1	30	116/9	34	116/F/14	218	118/A/7	23	118/C/25	163
94/F/5	214	114/2	30	116/10	32	116/F/15	218	118/A/8	23	118/C/26	163
94/F/6	214	114/4	34	116/11	34	116/F/16	218	118/A/9	23	118/C/27	163
94/P/1	200	114/5	32	116/12	34	116/F/17	218	118/C/1	163	118/C/28	163

Not all of the Arterferro items are available in **Arterferro Quick**, just a special selection.

Find out about the entire range in the catalogue

In **Arterferro Quick** non sono presenti tutti gli articoli Arterferro, ma solo una speciale selezione.

Scopri la gamma completa nel catalogo

*Compendium*

INDEX - INDICE

118/C/29	163	118/H/24	36	118/A/4/6000	20	123/3	180	127/2	178	129/4	165
118/C/30	163	118/H/25	36	118/A/5/6000	20	123/5	180	127/3	228	129/5	165
118/C/31	163	118/H/26	36	118/A/6/50X8	23	123/6	178	127/4	228	129/6	165
118/C/32	163	118/H/30	94	118/A/6/6000	23	124/1	179	127/5	228	129/7	167
118/C/33	163	118/13/S	23	118/A/6/S/L6	23	124/2	179	127/6	228	129/8	167
118/C/34	163	118/13/S/6000	23	118/A/7/6000	23	124/3	179	127/7	228	129/9	166
118/C/35	163	118/10/S1	23	118/A/8/6000	23	124/4	179	127/8	228	129/10	166
118/C/36	163	118/13/S1	23	118/A/9/6000	23	124/5	179	127/9	228	129/11	168
118/C/37	163	118/14/S2	23	118/C/40/T16	163	124/6	178	127/10	228	129/12	168
118/C/38	163	118/14/S2/6000	23	118/F/7/3000	34	124/7	179	127/11	228	129/15	174
118/C/39	163	118/14/S3	23	118/F/8/3000	34	124/8	179	127/12	228	129/16	175
118/C/40	163	118/27/S	23	118/24/6000/S	20	124/9	179	127/13	228	129/17	166
118/C/41	163	118/27/6000	23	118/7/S1/6000	22	124/11	171	127/14	228	129/18	166
118/C/42	163	118/A/6/S	23	118/8/S1/6000	22	124/12	171	127/15	228	129/19	175
118/C/43	163	118/A/6/20X8	23	118/9/S1/6000	22	124/13	171	127/16	228	129/20	175
118/C/44	163	118/A/6/20X8/6000	23	118/C/13/1200	163	124/14	171	128/1	225	130/1	167
118/C/45	163	118/A/9/S	23	118/C/16/1200	163	125/1	178	128/2	225	130/2	167
118/C/46	163	118/C/106	163	118/C/20/1200	163	125/2	178	128/3	224	130/3	167
118/C/47	163	118/1/6000	20	118/C/23/1200	163	126/1	180	128/4	224	130/4	167
118/C/48	163	118/15/Q/6	21	118/C/27/1200	163	126/2	180	128/5	224	130/5	167
118/C/49	163	118/2/6000	20	118/C/28/1200	163	126/6	178	128/6	224	130/6	167
118/C/50	163	118/3/6000	20	118/C/39/1200	163	126/8	179	128/7	224	130/7	167
118/C/51	163	118/4/6000	20	118/C/42/1200	163	126/9	178	128/8	224	130/8	165
118/C/52	163	118/5/6000	20	118/C/44/1200	163	126/13	179	128/9	224	130/9	167
118/C/53	163	118/6/6000	20	118/1/Q10/6000	20	126/14	179	128/10	224	130/10	167
118/C/54	163	118/7/6000	22	118/A/6/S/6000	23	126/15	180	128/11	224	130/11	165
118/C/55	163	118/8/6000	22	118/A/9/S/6000	23	126/16	180	128/12	224	130/12	165
118/C/56	163	118/A/6/SS	23	118/7/20X6/6000	22	126/18	180	128/13	224	130/13	165
118/C/57	163	118/E/2/S1	25	118/A/6/50X8/6000	23	126/19	178	128/14	224	130/14	165
118/C/58	163	118/E/2/S2	25	119/1	37	126/20	178	128/15	224	130/15	165
118/C/59	163	118/E/3/S4	25	119/1/5400	37	126/21	179	128/16	225	130/16	165
118/C/60	163	118/E/3/S5	25	119/2	37	126/A/1	180	128/17	225	130/17	165
118/C/61	163	118/E/4/S2	25	119/2/5400	37	126/A/2	177	128/18	225	130/18	165
118/C/62	163	118/E/4/S3	25	119/3	37	126/A/3	171	128/19	225	130/19	165
118/C/63	176	118/E/4/S4	25	119/3/5400	37	126/A/4	171	128/20	225	130/20	165
118/C/64	163	118/E/5/S3	25	119/4	94	126/A/5	171	128/21	225	130/21	165
118/C/65	163	118/E/6/S1	25	119/5	94	126/A/6	171	128/22	225	130/22	165
118/C/66	163	118/E/6/S3	25	119/6	94	126/A/7	171	128/23	225	130/23	165
118/C/67	163	118/E/6/S4	25	119/9	94	126/A/8	171	128/24	225	130/24	165
118/C/68	163	118/E/6/S5	25	119/10	94	126/A/9	171	128/25	225	130/25	165
118/C/72	163	118/E/7/S3	25	119/11	94	126/B/1	179	128/26	225	130/26	165
118/C/96	163	118/E/7/S5	25	119/12	94	126/B/2	179	128/27	225	130/27	165
118/C/97	163	118/E/8/S1	24	119/13	94	126/B/3	179	128/28	225	130/29	165
118/E/10	24	118/E/9/S1	25	119/16	94	126/B/6	179	128/31	181	130/30	165
118/E/12	24	118/E/9/S2	25	119/17	94	126/B/7	179	128/35	181	130/31	166
118/E/13	24	118/11/6000	23	119/18	94	126/B/8	179	128/36	225	130/32	166
118/E/14	24	118/12/6000	23	119/19	94	126/B/9	180	128/37	225	130/33	166
118/E/15	24	118/13/6000	23	119/20	94	126/C/7	180	128/38	225	130/34	166
118/E/16	25	118/14/6000	23	119/23	94	126/C/8	180	128/39	225	130/35	166
118/E/17	24	118/15/6000	21	119/24	94	126/D/1	178	128/C/2	181	130/36	166
118/E/18	24	118/16/6000	21	119/25	95	126/E/1	180	128/C/3	227	130/37	166
118/E/19	24	118/17/6000	21	119/26	95	126/F/1	224	128/C/4	227	130/38	166
118/F/10	34	118/18/6000	21	119/27	95	126/F/2	224	128/C/5	227	130/39	166
118/H/10	36	118/19/6000	21	119/28	100	126/F/3	224	128/C/6	227	130/40	166
118/H/11	36	118/20/6000	21	120/1	174	126/F/4	224	128/C/7	227	130/41	168
118/H/12	36	118/21/6000	21	120/2	174	126/F/5	224	128/C/8	227	130/42	168
118/H/13	36	118/22/6000	21	120/3	174	126/F/6	225	128/C/9	226	130/43	168
118/H/14	36	118/23/6000	21	121/4	174	126/F/7	225	128/D/9	175	130/44	168
118/H/15	36	118/24/6000	20	121/5	174	126/F/8	225	128/C/10	226	130/45	168
118/H/16	36	118/25/6000	20	121/6	174	126/F/9	225	128/C/11	226	130/46	168
118/H/17	36	118/C/1/Q16	163	121/7	174	126/A/10	171	128/C/12	227	130/47	168
118/H/18	36	118/C/7/Q16	163	121/8	174	126/F/10	225	128/C/13	227	130/48	168
118/H/19	36	118/7/S/6000	22	121/9	174	126/F/11	226	128/C/14	227	130/49	168
118/H/20	36	118/9/S/6000	22	121/10	174	126/F/12	226	128/C/15	227	130/50	168
118/H/21	36	118/A/1/6000	20	121/11	174	126/F/13	226	129/1	165	130/51	165
118/H/22	36	118/A/2/6000	20	122/A/1	178	126/F/14	226	129/2	165	130/52	165
118/H/23	36	118/A/3/6000	20	123/1	218	127/1	178	129/3	165	130/53	165

Not all of the Arterferro items are available in **Arterferro Quick**, just a special selection.

Find out about the entire range in the catalogue

In **Arterferro Quick** non sono presenti tutti gli articoli Arterferro, ma solo una speciale selezione.

Scopri la gamma completa nel catalogo

*Compendium*

INDEX - INDICE

130/54	165	132/B/88	164	148/2	92	158/18	40	164/8	255	171/39	248
130/55	165	132/C/10	164	149/1	92	158/19	40	164/9	255	171/40	248
130/56	165	132/C/12	164	149/2	92	158/20	38	164/10	255	171/41	248
130/57	165	132/C/13	164	154/1	222	158/21	38	167/3	183	171/42	248
130/58	165	132/C/14	164	154/2	222	158/22	38	167/4	183	178/20	183
130/59	165	132/C/15	164	154/3	222	158/23	38	167/6	183	178/22	183
130/60	165	132/C/16	164	154/4	222	158/24	38	167/8	183	178/24	183
132/48	164	132/C/17	164	154/5	222	158/25	38	167/11	183	178/29	183
132/C/1	164	132/C/18	164	154/A/1	222	158/26	38	167/14	183	178/30	183
132/C/2	164	132/C/19	164	154/A/2	222	158/27	38	167/15	174	178/31	183
132/C/3	164	132/C/20	164	154/A/3	222	158/28	38	167/16	174	178/35	183
132/C/4	164	132/C/21	164	154/A/4	222	158/29	38	168/3	250	178/36	183
132/C/5	164	132/C/22	164	154/A/5	222	158/30	38	168/4	250	180/50	20
132/C/6	164	132/C/23	164	154/A/6	222	158/31	39	168/5	250	180/51	23
132/C/7	164	132/C/28	164	154/A/7	222	158/32	39	168/6	250	180/53	20
132/C/8	164	132/C/29	164	154/A/8	222	158/33	39	169/1	251	180/54	20
132/C/9	164	132/D/10	164	154/B/1	222	158/34	41	169/2	251	180/50/6000	20
132/C/32	164	132/D/11	164	154/B/2	222	158/35	41	169/3	251	180/53/6000	20
132/D/1	164	132/D/12	164	154/B/3	222	158/36	41	169/4	250	180/54/6000	20
132/D/2	164	132/D/13	164	154/B/4	222	158/37	41	169/5	253	181/6	245
132/D/3	164	132/D/14	164	154/B/5	222	158/38	41	169/6	253	181/7	39
132/D/4	164	132/D/15	164	154/B/6	222	158/39	41	169/7	253	181/8	39
132/D/5	164	132/D/16	164	155/1	222	158/40	41	169/8	253	181/10	254
132/D/6	164	132/D/17	164	155/2	222	158/41	41	169/9	253	181/11	254
132/D/7	164	132/D/18	164	155/3	222	158/42	41	169/10	253	181/12	254
132/D/8	164	132/D/19	164	155/4	222	158/43	41	169/11	250	181/13	255
132/D/9	164	132/D/20	164	155/5	222	158/44	41	169/12	250	181/14	255
132/B/37	164	134/2	80	155/6	222	158/49	40	169/13	250	181/15	254
132/B/38	164	134/4	80	155/7	222	158/50	40	169/15	250	182/1	254
132/B/39	164	134/7	167	156/1	195	158/51	40	170/1	253	182/2	254
132/B/40	164	134/10	80	156/2	195	158/52	40	170/2	253	185/9	263
132/B/41	164	134/12	80	156/3	195	158/53	40	170/3	253	199/1	241
132/B/42	164	134/18	167	156/5	195	158/54	40	170/5	253	199/2	241
132/B/43	164	134/19	167	156/6	195	158/9/C	26	170/6	252	199/3	241
132/B/44	164	134/20	167	156/A/7	249	158/B/1	230	170/7	252	199/4	241
132/B/45	164	134/21	167	156/A/8	249	158/B/2	230	170/A/1	253	199/5	241
132/B/46	164	134/22	167	156/A/10	249	158/B/3	230	170/A/2	256	199/6	241
132/B/47	164	134/B/2	80	156/A/11	249	158/B/4	230	170/A/3	256	199/7	241
132/B/49	164	134/B/4	80	156/A/12	249	158/B/5	230	170/A/4	253	199/8	241
132/B/50	164	134/C/2	80	157/1	194	158/B/6	231	170/A/5	252	199/9	241
132/B/51	164	134/C/3	80	157/2	194	158/B/7	231	170/A/6	253	199/10	241
132/B/52	164	134/C/5	80	157/3	194	158/B/8	231	170/A/7	253	199/11	241
132/B/53	164	134/C/6	80	157/4	194	158/10/C	26	170/A/8	253	199/12	241
132/B/54	164	134/D/9	80	157/5	194	158/12/C	26	170/A/9	253	199/13	241
132/B/55	164	134/G/1	110	157/6	194	158/45/C	26	170/B/1	254	199/14	241
132/B/56	164	134/G/2	110	157/7	194	158/47/C	26	170/B/2	254	199/15	241
132/B/57	164	136/1	235	157/8	194	158/9/C/6000	26	170/B/3	254	199/16	241
132/B/58	164	136/2	235	157/9	194	158/10/C/6000	26	170/B/4	255	199/17	241
132/B/59	164	136/3	235	157/10	194	158/12/C/6000	26	170/B/5	254	200/3	54
132/B/60	164	136/4	235	157/11	194	158/45/C/6000	26	170/A/10	253	200/5	54
132/B/61	164	136/12	235	157/12	194	158/47/C/6000	26	170/A/11	253	200/9	54
132/B/62	164	136/13	235	157/13	194	159/1	230	171/1	240	200/12	54
132/B/63	164	138/1	234	157/14	194	159/2	230	171/2	240	200/14	54
132/B/64	164	138/2	234	157/15	194	159/3	230	171/3	240	200/16	54
132/B/65	164	138/4	234	158/1	40	159/4	230	171/4	240	200/18	54
132/B/66	164	138/15	234	158/2	40	159/5	230	171/5	240	200/5/S28	55
132/B/67	164	140/F/3	235	158/3	38	159/6	230	171/6	240	200/5/S44	55
132/B/68	164	140/F/4	235	158/4	39	159/7	230	171/7	240	200/5/S45	55
132/B/69	164	140/H/1	236	158/5	41	159/9	230	171/8	240	200/5/S46	55
132/B/70	164	140/H/2	236	158/6	41	159/10	230	171/9	240	200/18/S12	55
132/B/71	164	140/I/2	235	158/7	41	164/1	255	171/10	240	200/18/S13	55
132/B/72	164	140/I/3	235	158/8	41	164/2	255	171/11	240	200/18/S14	55
132/B/83	164	145/3	93	158/13	40	164/3	255	171/12	240	200/18/S24	55
132/B/84	164	145/4	93	158/14	40	164/4	255	171/13	240	202/1	218
132/B/85	164	146/1	93	158/15	40	164/5	255	171/14	240	202/2	218
132/B/86	164	146/4	93	158/16	40	164/6	255	171/37	248	202/3	218
132/B/87	164	148/1	92	158/17	40	164/7	255	171/38	248	202/4	218

Not all of the Arterferro items are available in **Arterferro Quick**, just a special selection.

Find out about the entire range in the catalogue

In **Arterferro Quick** non sono presenti tutti gli articoli Arterferro, ma solo una speciale selezione.

Scopri la gamma completa nel catalogo

*Compendium*

INDEX - INDICE

202/5	218	491/8	194	573/7	84	587/2	81	599/1	19	617/4	99
202/6	218	491/9	195	573/8	84	587/4	81	599/2	19	617/5	99
202/7	218	491/16	194	573/9	84	587/5	81	599/3	19	617/6	99
227/1	257	491/17	194	573/10	84	587/6	81	599/4	19	617/7	99
227/2	257	491/8/D89	194	576/1	85	587/7	81	599/5	19	620/1	59
227/3	257	491/8/D127	194	576/2	85	587/8	81	599/6	19	621/1	59
227/4	257	491/8/D133	194	576/3	85	587/9	81	599/7	19	622/1	22
227/16	257	491/8/D140	194	576/5	85	587/10	81	599/8	19	622/3	22
227/18	257	492/1	78	576/6	85	587/12	81	599/9	19	622/4	22
227/20	257	492/2	78	577/1	85	587/13	154	599/2/6000	19	622/5	22
227/22	257	493/1	76	577/2	85	587/14	81	599/3/6000	19	622/6	22
227/24	257	493/2	76	577/4	85	587/15	81	599/4/6000	19	622/4/S	22
227/27	257	494/1	78	577/5	85	587/16	81	599/5/6000	19	622/5/S	22
227/28	257	494/2	78	577/7	85	587/17	81	599/6/6000	19	622/5/S1	22
227/29	257	496/C/1/C	74	577/8	85	587/18	81	599/7/6000	19	622/5/S2	22
227/30	257	496/C/2/C	74	577/9	85	587/19	81	599/8/6000	19	622/1/6000	22
227/31	257	496/C/3/C	74	577/10	85	587/20	81	599/9/6000	19	622/3/6000	22
227/32	257	497/1/C	74	578/1	85	587/22	81	600/1	19	622/4/6000	22
227/33	257	497/2/C	74	578/2	85	587/24	81	600/2	19	622/5/6000	22
227/34	257	499/1/C	72	578/3	85	587/25	81	600/3	19	622/6/6000	22
227/35	257	499/2/C	72	578/4	85	587/26	81	600/4	19	622/4/S/6000	22
227/36	257	501/1	73	578/5	85	587/27	81	600/5	19	623/1	22
227/37	257	501/2	73	578/6	85	587/28	81	600/6	19	623/2	22
227/38	257	503/1	73	578/7	85	587/29	81	600/7	19	623/3	22
227/39	257	504/2/C	73	578/8	85	587/30	81	600/8	19	623/4	21
227/40	257	504/3/C	73	578/9	85	587/32	81	600/9	19	623/5	21
227/41	257	505/1	79	578/10	85	587/34	81	600/10	19	623/6	21
227/42	257	505/2	79	578/11	85	587/35	81	600/3/6000	19	623/7	21
227/43	257	505/3	79	578/12	85	587/36	81	600/4/6000	19	623/8	21
227/44	257	505/4	79	578/13	86	587/37	81	600/5/6000	19	623/9	21
227/45	257	507/1	76	578/14	86	587/38	81	600/6/6000	19	623/11	21
227/46	257	507/2	76	578/15	86	587/39	81	600/7/6000	19	623/12	22
227/47	257	508/1	78	578/16	86	587/40	81	600/8/6000	19	623/13	22
227/51	257	508/3/C	74	578/17	86	587/42	80	600/9/6000	19	623/2/S	22
227/52	257	508/4/C	74	578/18	86	587/44	80	600/10/6000	19	623/1/6000	22
227/53	257	509/1	78	578/19	86	587/46	80	604/6	129	623/2/6000	22
227/54	257	510/1	110	578/20	86	587/48	80	605/1	45	623/3/6000	22
227/55	257	511/1	110	578/18/S1	157	589/4	159	605/2	45	623/4/6000	21
227/56	257	537/1	93	582/1	215	589/5	159	605/3	45	623/5/6000	21
227/57	257	537/2	93	584/1	96	591/1	160	605/4	45	623/6/6000	21
227/58	257	537/3	93	584/2	96	591/2	160	605/5	45	623/7/6000	21
446/4	188	537/8	92	584/4	96	591/3	160	605/6	45	623/8/6000	21
450/1	188	537/9	92	584/5	96	591/4	160	605/7	45	623/9/6000	21
452/1	188	539/2	111	584/6	110	593/10	183	605/8	45	623/11/6000	21
454/3	187	540/2	105	584/7	110	593/11	183	606/1	44	623/12/6000	22
455/2	188	541/1	106	584/A/4	96	593/3/S1	183	606/2	44	623/13/6000	22
459/1	189	541/2	106	584/A/5	96	593/3/S4	183	606/3	44	625/1	21
462/1	103	561/1	84	584/A/6	96	595/7/S	55	606/4	44	625/2	21
462/2	103	561/2	84	584/B/1	96	596/4/S3	55	607/1	44	625/3	21
462/3	103	561/3	84	584/B/2	96	598/1	74	607/2	44	625/4	21
462/4	103	561/4	84	584/B/3	97	598/2	19	607/3	44	625/5	21
473/1	112	561/5	84	585/1	80	598/3	19	607/4	44	625/6	21
474/1	112	561/6	84	585/2	80	598/4	19	608/5	49	625/7	21
475/1	112	562/1	84	586/1	80	598/5	19	608/6	49	625/8	21
475/2	112	562/2	84	586/6	81	598/6	74	608/7	49	625/9	21
479/1	110	572/1	84	586/7	81	598/7	74	608/8	49	626/1	37
479/2	112	572/2	84	586/8	81	598/8	19	609/2	51	626/2	37
479/3	110	572/3	84	586/9	81	598/10	19	614/4	57	626/3	37
480/1	190	572/4	84	586/10	81	598/11	19	614/5	57	626/4	37
483/1	108	572/5	153	586/11	81	598/12	19	614/6	57	626/5	37
483/2	108	572/6	153	586/12	81	598/13	19	615/1	99	626/6	37
487/1	111	572/7	153	586/13	81	598/14	19	615/2	99	626/7	37
488/1	111	572/8	153	586/14	81	598/15	19	615/3	99	626/8	37
489/1	77	573/1	84	586/15	81	598/16	19	615/4	99	626/9	37
489/2	77	573/2	84	586/16	154	598/18	19	617/1	99	626/10	21
490/1	77	573/3	84	586/17	154	598/11/6000	19	617/2	99	626/12	21
490/2	77	573/4	84	586/9/1500	154	598/13/6000	19	617/3	99	626/13	21

Not all of the Arteferro items are available in **Arteferro Quick**, just a special selection.

Find out about the entire range in the catalogue

In **Arteferro Quick** non sono presenti tutti gli articoli Arteferro, ma solo una speciale selezione.

Scopri la gamma completa nel catalogo

*Compendium*

INDEX - INDICE

626/14	21	661/3	236	713/2	131	727/29	171	749/18	181	810/B/14/T	30
626/15	21	661/4	236	714/1	150	727/30	171	749/19	181	810/B/15/T	30
626/16	21	661/5	236	715/1	131	727/31	171	749/22	182	810/B/16/T	30
626/10/6000	21	662/1	236	715/2	131	727/32	171	750/3	235	810/B/17/T	30
626/12/6000	21	662/2	236	716/1	131	727/33	171	751/1	236	810/B/18/T	30
626/13/6000	21	662/5	236	716/2	131	727/34	171	797/1	73	810/B/19/T	30
626/14/6000	21	662/6	236	716/3	131	727/35	171	797/2	72	810/B/20/T	30
626/15/6000	21	663/1	236	716/4	131	727/36	171	797/4	74	810/12/6000	26
626/16/6000	21	663/2	236	717/5/S1	131	727/37	171	797/5	73	810/13/6000	26
630/1	210	663/5	236	717/5/S3	131	737/1	220	797/6	72	810/7/C/6000	26
630/2	210	663/6	236	717/5/S4	131	737/2	220	797/7	72	810/8/C/6000	26
630/3	210	664/1	234	719/1	189	737/3	220	799/1	79	811/1	28
630/4	210	664/2	234	719/2	189	737/4	220	800/4	79	811/2	28
630/5	210	664/7	236	720/1	189	737/5	220	801/1	84	811/3	28
630/6	210	664/8	236	720/2	188	737/6	220	801/2	86	811/5	28
630/7	210	665/1	234	722/1	168	737/7	220	801/3	104	811/8	28
630/8	210	665/2	234	722/2	168	737/8	220	801/4	104	811/3/T	30
630/9	210	666/2	235	722/3	167	738/1	220	801/5	86	811/4/T	30
630/10	210	666/5	235	722/4	167	738/2	220	801/6	78	811/5/T	30
630/11	210	666/6	235	722/5	166	738/3	220	801/7	84	811/6/T	30
630/12	210	666/9	235	722/6	166	738/4	220	801/8	86	811/7/T	30
630/13	210	673/2	236	722/7	175	738/5	220	802/1	77	811/8/T	30
641/1	204	679/1	190	722/8	175	738/6	220	802/4	245	811/9/T	30
641/2	204	679/2	190	723/5	174	738/7	220	802/5	245	811/10/T	30
641/3	204	679/3	190	724/1	180	738/8	220	810/1	26	812/1	26
641/4	204	680/1	190	725/1	178	738/9	220	810/2	26	812/2	26
641/5	204	681/1	107	725/2	180	738/10	220	810/3	26	812/3	26
641/6	204	681/2	107	726/1	178	738/11	220	810/5	26	812/4	26
641/7	204	681/3	107	726/2	178	739/1	226	810/10	26	812/5	26
641/8	204	681/4	107	726/3	178	739/2	226	810/11	26	812/6	26
642/1	207	685/1	107	726/4	178	739/3	226	810/12	26	812/7	26
642/2	207	685/2	107	726/6	179	739/4	226	810/13	26	812/8	26
642/3	207	685/3	107	726/7	179	739/5	226	810/7/C	26	812/9	29
642/4	207	685/4	107	726/9	180	739/6	226	810/8/C	26	812/10	29
646/1	209	685/5	107	726/10	180	741/1	227	810/A/1	26	812/11	29
646/2	209	685/6	107	726/11	180	741/2	227	810/A/2	26	812/12	28
646/3	209	691/6	235	726/12	180	741/3	227	810/A/3	26	812/13	28
646/4	209	691/7	235	726/20	171	741/4	227	810/A/4	26	812/14	28
646/5	209	692/8	235	726/21	171	741/5	227	810/A/5	26	812/15	28
646/6	209	695/4	234	726/22	171	741/6	227	810/A/6	26	812/5/S	26
646/7	209	695/6	248	726/23	171	741/7	227	810/A/7	26	812/6/S	26
646/8	209	695/7	248	727/1	178	741/8	227	810/A/9	26	812/1/S4	26
653/1	65	695/8	248	727/2	178	742/1	223	810/A/10	26	812/1/S8	26
653/2	65	695/9	248	727/3	178	742/2	223	810/A/11	26	812/1/S9	26
653/3	65	695/10	248	727/4	178	742/3	223	810/A/12	26	812/12/S	28
653/4	65	695/11	248	727/5	178	742/4	223	810/A/13	26	812/12/T	30
653/5	66	696/1	70	727/6	178	742/5	223	810/A/14	26	812/13/T	30
654/1	65	696/3	131	727/7	179	742/6	223	810/A/15	26	812/15/T	30
654/2	66	697/1	234	727/8	179	747/12	224	810/A/16	26	812/16/S	28
654/3	66	697/3	234	727/9	179	747/13	224	810/A/18	26	812/3/S1	26
654/4	66	697/4	234	727/10	180	747/14	224	810/A/23	26	812/3/S2	26
654/5	65	697/5	248	727/11	180	747/15	225	810/A/24	26	812/5/S1	26
655/1	208	697/7	248	727/12	171	747/16	225	810/B/19	28	812/5/S4	26
655/2	208	697/8	248	727/13	171	747/17	225	810/B/20	28	812/5/S6	26
655/3	208	700/1	235	727/14	171	747/18	224	810/B/1/T	30	812/5/S8	26
655/4	208	700/4	235	727/15	171	747/19	224	810/B/2/T	30	812/5/S9	26
655/5	208	700/5	235	727/16	171	747/20	224	810/B/3/T	30	812/14/XL	28
656/1	208	700/10	235	727/17	171	747/21	225	810/B/4/T	30	812/5/S10	26
658/7	205	701/5	234	727/18	171	747/22	225	810/B/5/T	30	812/8/S/2	26
658/8	205	701/6	235	727/19	171	747/23	225	810/B/6/T	30	812/12/T/S	30
659/10	205	705/1	234	727/20	171	749/1	181	810/B/7/T	30	819/1	244
659/11	205	705/3	235	727/21	171	749/2	181	810/B/8/T	30	819/2	244
660/10	234	705/5	235	727/22	171	749/8	181	810/1/6000	26	819/3	244
660/11	234	711/3	234	727/23	171	749/9	181	810/2/6000	26	819/4	244
660/12	234	711/5	234	727/25	171	749/10	181	810/A/19/T	35	819/5	244
661/1	236	711/6	234	727/26	171	749/13	181	810/A/20/T	35	819/6	244
661/2	236	713/1	131	727/28	171	749/14	181	810/B/13/T	30	819/7	244



Not all of the Arterferro items are available in **Arterferro Quick**, just a special selection.

Find out about the entire range in the catalogue

In **Arterferro Quick** non sono presenti tutti gli articoli Arterferro, ma solo una speciale selezione.

Scopri la gamma completa nel catalogo

*Compendium*

INDEX - INDICE

819/8	244	840/2	254	851/6	240	876/11	261	1050/3	105	1138/8	85
819/9	244	840/3	254	851/7	240	877/1	261	1050/4	105	1138/9	85
819/10	244	840/4	254	851/8	240	877/2	261	1051/1	109	1138/10	85
819/11	244	840/5	254	851/9	240	877/3	261	1051/2	109	1148/2	94
819/12	218	840/6	254	851/10	240	877/4	261	1051/3	109	1148/3	94
819/13	218	841/7	245	851/11	241	877/5	261	1051/4	106	1148/5	94
819/14	218	849/1	258	851/12	241	877/6	261	1051/5	106	1148/6	94
819/15	244	849/2	258	851/14	241	877/7	261	1064/1	111	1148/8	94
819/16	244	849/3	258	851/15	241	877/8	261	1064/2	111	1148/9	94
819/17	244	849/4	258	851/16	241	878/1	262	1064/3	111	1148/11	94
819/18	244	850/1	240	851/17	241	878/2	262	1066/4	146	1148/12	94
830/1	255	850/2	240	851/18	241	878/3	262	1066/5	146	1148/14	94
830/2	255	850/3	240	852/1	241	878/4	262	1074/1	136	1148/15	94
830/3	255	850/4	240	852/2	241	878/5	262	1074/2	136	1148/17	94
830/7	255	850/5	240	852/4	238	878/6	262	1080/9	165	1148/18	94
830/10	255	850/6	240	852/5	238	878/7	262	1080/9/S1	165	1149/1	102
830/13	255	850/7	240	852/6	238	878/8	262	1080/9/S3	165	1149/2	102
830/15	255	850/8	240	852/7	238	879/2	262	1080/9/S4	165	1149/3	102
830/16	255	850/9	240	852/8	238	879/3	262	1080/9/S8	165	1149/4	102
830/17	255	850/10	240	852/10	238	880/1	263	1080/9/S9	165	1149/5	102
830/18	255	850/11	240	852/11	238	880/2	263	1080/9/200	165	1149/6	102
830/19	255	850/12	240	852/12	238	880/3	263	1080/9/S10	165	1149/7	104
830/20	255	850/13	240	852/13	238	880/4	263	1080/9/S11	165	1149/8	104
830/21	255	850/14	240	852/14	238	880/5	263	1080/9/S12	165	1150/3	103
831/1	250	850/15	240	852/15	238	881/1	263	1080/9/S13	165	1150/4	103
833/1	251	850/16	240	869/1	260	881/2	263	1080/9/S14	165	1150/7	103
833/2	251	850/17	240	869/2	260	881/3	263	1082/1	115	1150/8	103
833/3	251	850/18	240	870/1	260	881/4	263	1082/2	115	1151/1	102
833/4	250	850/19	240	870/2	260	881/5	263	1124/1	97	1151/2	102
833/6	251	850/20	240	870/3	260	881/6	263	1124/2	97	1151/3	102
834/1	251	850/21	240	870/4	260	881/7	263	1127/1	96	1151/4	102
834/2	253	850/22	240	871/1	260	881/8	263	1127/2	96	1151/5	94
834/3	251	850/23	240	872/1	260	881/9	263	1135/1	85	1151/6	94
835/1	252	850/24	240	872/2	260	882/1	263	1135/2	85	1151/7	94
835/2	252	850/25	240	872/3	260	882/2	263	1135/3	85	1158/5	153
835/3	252	850/26	240	872/4	260	882/3	263	1135/4	85	1158/6	153
835/4	252	850/27	240	872/5	260	882/40	264	1136/1	85	1158/8	155
835/5	252	850/28	240	872/6	260	883/1	263	1136/2	85	1163/1	230
835/6	250	850/29	240	872/7	260	883/3	263	1136/3	85	1163/2	230
835/7	250	850/30	240	872/8	260	883/4	263	1136/4	85	1163/3	230
835/8	250	850/31	240	872/9	260	1009/1	187	1136/5	85	1163/4	230
835/9	250	850/32	240	872/10	260	1009/2	187	1136/6	85	1163/5	230
836/1	250	850/33	240	872/11	260	1011/1	188	1136/7	85	1163/6	230
836/4	251	850/34	240	873/1	260	1013/1	187	1136/8	85	1163/7	230
837/2	252	850/35	240	873/2	260	1013/2	187	1136/9	85	1163/8	230
837/3	252	850/36	240	873/3	260	1014/1	187	1136/10	85	1163/10	231
837/4	256	850/37	240	874/1	261	1014/2	187	1137/1	84	1163/11	231
837/5	256	850/38	240	874/2	261	1014/3	187	1137/2	84	1163/12	231
837/7	256	850/39	240	874/3	261	1024/1	189	1137/3	84	1164/1	231
837/8	256	850/40	240	874/4	261	1038/1	108	1137/4	84	1164/2	231
837/9	256	850/41	240	874/5	261	1038/2	108	1137/5	84	1164/3	231
837/10	256	850/42	240	875/1	261	1039/1	108	1137/6	84	1164/4	231
838/1	251	850/43	240	875/2	261	1040/1	108	1137/7	84	1164/5	231
838/2	251	850/44	240	875/3	261	1043/2	148	1137/8	84	1165/5	183
838/3	251	850/45	240	875/4	261	1045/5	105	1137/9	84	1165/6	183
838/4	251	850/46	240	875/5	261	1045/6	105	1137/10	84	1166/1	130
839/1	252	850/47	240	875/6	261	1045/7	105	1137/11	157	1166/2	130
839/2	252	850/48	240	876/1	261	1045/8	105	1137/12	157	1166/3	130
839/3	252	850/49	240	876/2	261	1046/1	105	1137/13	157	1166/4	130
839/4	252	850/50	240	876/3	261	1046/2	105	1137/14	157	1167/1	130
839/5	253	850/51	240	876/4	261	1046/3	200	1138/1	84	1167/2	130
839/6	253	850/52	240	876/5	261	1046/4	200	1138/2	84	1167/3	130
839/7	253	851/1	240	876/6	261	1046/5	200	1138/3	84	1167/4	130
839/8	253	851/2	240	876/7	261	1046/6	200	1138/4	84	1170/1	129
839/9	253	851/3	240	876/8	261	1046/7	200	1138/5	84	1170/2	129
839/10	253	851/4	240	876/9	261	1049/1	109	1138/6	84	1170/5	129
840/1	254	851/5	240	876/10	261	1050/1	105	1138/7	85	1170/6	129

Not all of the Arterferro items are available in **Arterferro Quick**, just a special selection.

Find out about the entire range in the catalogue

In **Arterferro Quick** non sono presenti tutti gli articoli Arterferro, ma solo una speciale selezione.

Scopri la gamma completa nel catalogo

*Compendium*

INDEX - INDICE

1171/1	129	1244/10	223	1260/44	167	1261/49	167	1263/5	167	1294/10	211
1171/2	130	1244/11	223	1260/45	167	1261/50	167	1263/6	167	1294/11	211
1176/1/S	91	1244/12	223	1260/46	167	1261/51	167	1263/7	167	1294/12	211
1176/2/S	91	1244/13	223	1260/47	167	1261/52	167	1263/8	167	1294/13	211
1176/3/S	91	1244/14	223	1260/48	167	1261/53	167	1263/9	167	1294/14	211
1176/4/S	91	1244/15	223	1260/49	167	1261/54	167	1263/10	167	1294/15	211
1177/1	91	1244/16	223	1260/50	167	1261/55	167	1263/11	167	1294/16	211
1177/2	91	1244/17	223	1260/51	167	1261/57	167	1263/12	167	1294/17	211
1177/3	91	1244/18	223	1260/52	167	1261/59	167	1263/13	166	1294/18	211
1177/4	91	1244/19	223	1260/53	167	1261/61	167	1263/14	166	1294/19	211
1177/5	91	1244/20	223	1260/54	167	1261/63	167	1263/15	166	1294/20	211
1177/6	91	1244/21	223	1260/55	167	1261/65	167	1263/16	166	1295/1	201
1177/7	91	1244/22	223	1260/57	167	1261/67	167	1263/17	166	1295/2	201
1177/8	91	1244/23	223	1260/59	167	1261/69	167	1263/18	166	1295/3	201
1177/9	91	1251/1	80	1260/61	167	1261/71	167	1263/19	166	1295/4	201
1177/10	91	1251/2	80	1260/63	167	1262/1	167	1263/20	166	1295/5	201
1179/1	91	1251/3	80	1260/65	167	1262/2	167	1263/21	166	1295/6	201
1179/2	91	1251/4	80	1260/67	167	1262/3	167	1263/22	166	1295/7	201
1179/3	91	1251/7	80	1260/69	167	1262/4	167	1263/23	166	1296/1	201
1179/4	91	1251/8	80	1260/71	167	1262/5	167	1263/24	166	1296/2	201
1184/1	73	1251/9	80	1261/1	168	1262/6	167	1263/25	167	1296/3	201
1184/2	73	1251/10	80	1261/2	168	1262/7	167	1263/26	167	1296/4	201
1184/3	75	1251/11	80	1261/3	167	1262/8	167	1263/27	166	1296/5	201
1184/5	73	1251/12	80	1261/4	168	1262/9	167	1263/28	166	1296/6	201
1184/6	73	1260/1	168	1261/5	168	1262/10	167	1263/29	166	1296/7	201
1185/1	75	1260/2	168	1261/6	168	1262/11	167	1263/30	166	1296/8	201
1185/2	73	1260/3	168	1261/7	168	1262/12	167	1263/31	166	1296/9	201
1185/4	73	1260/4	168	1261/8	168	1262/13	166	1263/32	166	1296/10	201
1187/3	74	1260/5	168	1261/9	168	1262/14	166	1264/5	155	1296/11	201
1187/4	75	1260/6	168	1261/10	168	1262/15	166	1267/9	158	1296/12	201
1199/2	79	1260/7	168	1261/11	168	1262/16	166	1268/52	158	1296/13	201
1199/3	74	1260/8	168	1261/12	168	1262/17	166	1268/53	158	1297/2	204
1203/1	104	1260/9	168	1261/13	168	1262/18	166	1269/7	160	1297/3	204
1203/2	104	1260/10	168	1261/14	168	1262/19	166	1269/11	160	1297/7	204
1204/1	104	1260/11	168	1261/15	168	1262/20	166	1270/29	155	1299/5	195
1205/1	91	1260/12	168	1261/16	168	1262/21	166	1271/3	158	1299/6	195
1205/2	91	1260/13	168	1261/17	168	1262/22	166	1271/4	158	1299/7	195
1229/1	92	1260/14	168	1261/18	168	1262/23	166	1271/5	158	1299/8	195
1229/2	92	1260/15	168	1261/19	166	1262/24	166	1276/1	159	1300/2	183
1229/3	93	1260/16	168	1261/20	166	1262/25	167	1279/3	69	1301/1	202
1229/4	92	1260/17	168	1261/21	166	1262/26	167	1279/4	69	1301/2	202
1229/5	92	1260/18	168	1261/22	166	1262/27	167	1281/1	68	1301/3	202
1230/2	93	1260/19	166	1261/23	166	1262/28	167	1281/2	68	1301/4	202
1230/4	93	1260/20	166	1261/24	166	1262/29	167	1281/3	68	1301/5	202
1231/1	92	1260/21	166	1261/25	166	1262/30	167	1281/4	68	1301/6	202
1231/2	92	1260/22	166	1261/26	166	1262/31	167	1281/5	67	1301/7	202
1243/1	221	1260/23	166	1261/27	166	1262/32	167	1281/6	67	1301/8	202
1243/2	221	1260/24	166	1261/28	166	1262/33	167	1281/7	67	1301/9	202
1243/3	221	1260/25	166	1261/29	166	1262/34	167	1281/8	67	1301/10	202
1243/4	221	1260/26	166	1261/30	166	1262/35	167	1281/9	67	1308/1	153
1243/5	221	1260/27	166	1261/31	166	1262/36	167	1281/10	67	1308/2	153
1243/6	221	1260/28	166	1261/32	166	1262/37	166	1281/11	67	1308/3	153
1243/7	221	1260/29	166	1261/33	166	1262/38	166	1281/12	67	1308/4	153
1243/8	221	1260/30	166	1261/34	166	1262/39	166	1281/13	70	1308/7	153
1243/9	221	1260/31	166	1261/35	166	1262/40	166	1281/14	70	1308/8	153
1243/10	221	1260/32	166	1261/36	166	1262/41	166	1281/1/S	68	1308/9	153
1243/11	221	1260/33	166	1261/37	167	1262/42	166	1281/3/S	68	1308/11	153
1243/12	221	1260/34	166	1261/38	167	1262/43	166	1281/2/S2	68	1308/12	153
1244/1	223	1260/35	166	1261/40	167	1262/44	166	1281/4/S2	68	1308/13	153
1244/2	223	1260/36	166	1261/41	167	1262/45	166	1290/1	207	1311/1	63
1244/3	223	1260/37	167	1261/42	167	1262/46	166	1290/2	207	1311/2	63
1244/4	223	1260/38	167	1261/43	167	1262/47	166	1290/3	207	1311/3	63
1244/5	223	1260/39	167	1261/44	167	1262/48	166	1291/1	207	1311/4	63
1244/6	223	1260/40	167	1261/45	167	1263/1	167	1291/2	207	1317/1	194
1244/7	223	1260/41	167	1261/46	167	1263/2	167	1291/3	207	1317/2	194
1244/8	223	1260/42	167	1261/47	167	1263/3	167	1291/4	207	1317/3	195
1244/9	223	1260/43	167	1261/48	167	1263/4	167	1291/5	207	1317/4	195

Not all of the Arterferro items are available in **Arterferro Quick**, just a special selection.

Find out about the entire range in the catalogue

In **Arterferro Quick** non sono presenti tutti gli articoli Arterferro, ma solo una speciale selezione.

Scopri la gamma completa nel catalogo

Compendium

INDEX - INDICE

1317/5	195	1320/25	195	1368/27	17	1368/96	18	1368/60/6000	18	1370/17	20
1317/6	194	1320/26	195	1368/28	17	1368/97	18	1368/61/6000	18	1370/18	20
1317/7	194	1320/27	195	1368/29	17	1368/98	18	1368/62/6000	18	1370/19	20
1317/8	194	1320/28	195	1368/30	17	1368/99	18	1368/63/6000	18	1370/20	20
1317/9	194	1320/29	195	1368/31	17	1368/100	18	1368/64/6000	18	1370/21	20
1317/10	194	1320/30	195	1368/32	17	1368/101	18	1368/65/6000	18	1370/22	20
1317/11	194	1321/1	239	1368/33	17	1368/102	18	1368/66/6000	18	1370/23	20
1317/12	195	1321/2	239	1368/34	17	1368/103	18	1368/67/6000	18	1370/24	20
1317/13	195	1321/4	239	1368/35	17	1368/22/S	17	1368/68/6000	18	1370/25	20
1317/14	195	1321/5	239	1368/37	18	1368/25/S	17	1368/69/6000	18	1370/1/6000	35
1317/15	195	1321/6	239	1368/38	18	1368/1/6000	17	1368/70/6000	18	1370/2/6000	35
1317/16	195	1321/8	239	1368/39	18	1368/2/6000	17	1368/71/6000	18	1370/3/6000	35
1317/17	195	1321/9	195	1368/40	18	1368/3/6000	17	1368/72/6000	18	1370/4/6000	35
1317/18	195	1321/10	239	1368/41	18	1368/4/6000	17	1368/73/6000	18	1370/13/6000	20
1317/19	195	1321/11	195	1368/42	18	1368/5/6000	17	1368/74/6000	18	1370/14/6000	20
1317/20	195	1321/12	239	1368/43	18	1368/6/6000	17	1368/75/6000	18	1370/15/6000	20
1317/21	195	1328/3	235	1368/44	18	1368/7/6000	17	1368/76/6000	18	1370/16/6000	20
1317/22	195	1328/6	234	1368/45	18	1368/8/6000	17	1368/77/6000	18	1370/17/6000	20
1317/23	195	1358/1	59	1368/46	18	1368/9/6000	17	1368/78/6000	18	1370/18/6000	20
1317/24	194	1358/2	59	1368/47	18	1368/10/6000	17	1368/79/6000	18	1370/19/6000	20
1317/25	194	1360/1	45	1368/48	18	1368/11/6000	18	1368/80/6000	18	1370/20/6000	20
1317/27	194	1360/2	45	1368/49	18	1368/12/6000	18	1368/81/6000	18	1370/21/6000	20
1317/28	194	1360/3	45	1368/50	18	1368/13/6000	18	1368/82/6000	18	1370/22/6000	20
1318/1	195	1360/4	45	1368/51	18	1368/14/6000	18	1368/83/6000	18	1370/23/6000	20
1318/2	195	1360/5	45	1368/52	18	1368/15/6000	18	1368/84/6000	18	1370/24/6000	20
1318/3	195	1360/6	44	1368/53	18	1368/16/6000	18	1368/85/6000	18	1370/25/6000	20
1318/4	195	1360/7	45	1368/54	18	1368/17/6000	18	1368/86/6000	18	1373/1	35
1318/5	195	1360/8	52	1368/55	18	1368/18/6000	18	1368/87/6000	18	1373/2	26
1318/6	195	1360/9	52	1368/57	18	1368/19/6000	18	1368/88/6000	18	1373/3	26
1318/7	195	1360/10	52	1368/58	18	1368/20/6000	17	1368/89/6000	18	1373/4	26
1318/8	195	1360/11	52	1368/59	18	1368/21/6000	17	1368/90/6000	18	1373/1/6000	35
1318/9	195	1360/12	52	1368/60	18	1368/22/6000	17	1368/91/6000	18	1373/2/6000	26
1318/10	195	1360/13	52	1368/61	18	1368/23/6000	17	1368/92/6000	18	1373/3/6000	26
1318/11	195	1361/1	45	1368/62	18	1368/24/6000	17	1368/93/6000	18	1373/4/6000	26
1318/12	195	1361/2	45	1368/63	18	1368/25/6000	17	1368/94/6000	18	1374/1	24
1318/13	195	1361/3	45	1368/64	18	1368/26/6000	17	1368/95/6000	18	1374/2	24
1318/14	195	1361/4	45	1368/65	18	1368/27/6000	17	1368/96/6000	18	1374/3	24
1318/15	195	1361/5	45	1368/66	18	1368/28/6000	17	1368/97/6000	18	1374/4	24
1318/16	195	1361/6	45	1368/67	18	1368/29/6000	17	1368/98/6000	18	1374/5	24
1318/17	195	1361/7	45	1368/68	18	1368/30/6000	17	1368/99/6000	18	1374/6	24
1319/2	195	1361/8	45	1368/69	18	1368/31/6000	17	1368/100/6000	18	1374/7	24
1319/3	195	1368/1	17	1368/70	18	1368/32/6000	17	1368/101/6000	18	1374/8	24
1319/6	195	1368/2	17	1368/71	18	1368/33/6000	17	1368/102/6000	18	1374/9	24
1320/1	194	1368/3	17	1368/72	18	1368/34/6000	17	1368/103/6000	18	1374/10	24
1320/2	194	1368/4	17	1368/73	18	1368/35/6000	17	1368/22/S/6000	17	1374/11	24
1320/3	194	1368/5	17	1368/74	18	1368/37/6000	18	1368/23/6000/Z	17	1374/12	24
1320/4	194	1368/6	17	1368/75	18	1368/38/6000	18	1368/25/S/6000	17	1374/13	24
1320/5	194	1368/7	17	1368/76	18	1368/39/6000	18	1369/1	22	1374/14	24
1320/6	194	1368/8	17	1368/77	18	1368/40/6000	18	1369/1/S	22	1374/15	24
1320/7	194	1368/9	17	1368/78	18	1368/41/6000	18	1369/1/S1	22	1374/16	24
1320/8	194	1368/10	17	1368/79	18	1368/42/6000	18	1369/1/S2	22	1374/17	24
1320/9	194	1368/11	18	1368/80	18	1368/43/6000	18	1369/1/6000	22	1374/18	24
1320/10	194	1368/12	18	1368/81	18	1368/44/6000	18	1369/1/S/6000	22	1374/19	24
1320/11	194	1368/13	18	1368/82	18	1368/45/6000	18	1369/1/S1/6000	22	1374/20	24
1320/12	194	1368/14	18	1368/83	18	1368/46/6000	18	1369/1/S2/6000	22	1374/21	24
1320/13	195	1368/15	18	1368/84	18	1368/47/6000	18	1369/2	22	1374/22	24
1320/14	195	1368/16	18	1368/85	18	1368/48/6000	18	1369/2/6000	22	1374/23	24
1320/15	195	1368/17	18	1368/86	18	1368/49/6000	18	1370/1	35	1374/24	24
1320/16	195	1368/18	18	1368/87	18	1368/50/6000	18	1370/2	35	1374/25	24
1320/17	195	1368/19	18	1368/88	18	1368/51/6000	18	1370/3	35	1374/26	24
1320/18	195	1368/20	17	1368/89	18	1368/52/6000	18	1370/4	35	1374/27	24
1320/19	195	1368/21	17	1368/90	18	1368/53/6000	18	1370/11	75	1374/29	24
1320/20	195	1368/22	17	1368/91	18	1368/54/6000	18	1370/12	75	1374/30	24
1320/21	195	1368/23	17	1368/92	18	1368/55/6000	18	1370/13	20	1374/5/S	25
1320/22	195	1368/24	17	1368/93	18	1368/57/6000	18	1370/14	20	1374/9/S	25
1320/23	195	1368/25	17	1368/94	18	1368/58/6000	18	1370/15	20	1374/13/S	24
1320/24	195	1368/26	17	1368/95	18	1368/59/6000	18	1370/16	20	1374/2/S1	25

Not all of the Arterferro items are available in **Arterferro Quick**, just a special selection.

Find out about the entire range in the catalogue

In **Arterferro Quick** non sono presenti tutti gli articoli Arterferro, ma solo una speciale selezione.

Scopri la gamma completa nel catalogo

*Compendium*

INDEX - INDICE

1374/2/S2	25	1380/2	176	1391/11	228	1395/6	218	1411/9	239	1414/15	240
1374/3/S2	25	1381/1	176	1391/12	228	1395/7	218	1412/1	240	1414/16	240
1374/3/S4	25	1381/2	176	1391/13	228	1395/8	218	1412/2	240	1414/17	240
1374/4/S1	25	1381/3	176	1391/14	228	1395/9	218	1412/3	240	1414/18	240
1374/9/S1	25	1381/7	176	1391/15	228	1395/10	218	1412/4	240	1414/19	240
1374/10/S2	25	1381/8	176	1391/16	228	1396/1	218	1412/5	240	1414/20	240
1374/10/S3	25	1381/9	176	1391/17	228	1396/2	218	1412/6	240	1414/21	240
1374/10/S4	24	1382/1	163	1391/18	228	1396/3	218	1412/7	240	1414/22	241
1374/10/S6	25	1382/2	163	1391/19	228	1396/4	218	1412/8	240	1470/8	245
1374/11/S1	25	1382/3	163	1391/20	228	1396/5	218	1412/9	240	1470/9	245
1374/11/S2	25	1382/4	163	1391/21	228	1398/1	182	1412/10	240	1474/1	252
1374/11/S3	25	1382/5	163	1391/22	228	1398/2	182	1412/11	240	1474/2	252
1374/11/S4	25	1382/6	163	1391/23	228	1399/1	182	1412/12	240	1474/3	252
1374/11/S5	24	1382/7	163	1392/1	224	1400/1	182	1412/13	240	1474/4	252
1374/12/S1	25	1382/8	163	1392/3	225	1400/2	182	1412/14	240	1474/5	251
1374/12/S2	25	1382/13	176	1392/4	225	1404/1	181	1412/15	240	1474/6	248
1374/12/S4	25	1382/14	176	1392/5	226	1404/2	181	1412/16	240	1474/7	248
1374/15/S2	25	1382/19	176	1392/6	226	1404/3	181	1412/17	240	1474/8	248
1377/5	28	1382/20	176	1392/7	226	1404/4	181	1412/18	240	1474/9	248
1377/11	26	1385/1	175	1393/2	186	1404/5	181	1412/19	240	1474/10	248
1377/18	28	1385/2	175	1393/4	234	1404/6	181	1412/20	240	1475/7	251
1377/23	26	1385/3	175	1393/5	234	1404/7	181	1412/21	240	1559/1	262
1377/40	28	1385/4	167	1393/6	234	1404/8	181	1412/22	240	1559/2	262
1377/41	28	1385/5	167	1393/7	245	1404/9	181	1412/23	240	1641/1	189
1377/42	28	1385/6	175	1393/10	227	1405/1	247	1412/24	240	1641/2	189
1377/1/T	30	1385/7	166	1393/11	227	1405/2	247	1412/25	240	1641/5	189
1377/2/T	30	1385/8	166	1393/12	227	1405/3	247	1412/26	240	1641/6	189
1377/3/T	30	1385/9	175	1393/13	227	1408/1	245	1412/27	241	1647/3	112
1377/4/T	30	1385/10	167	1393/14	227	1408/3	245	1412/28	241	1657/1	189
1377/5/T	30	1385/11	167	1393/15	227	1408/4	245	1413/1	240	1657/4	189
1377/7/T	30	1385/12	175	1393/16	227	1408/5	244	1413/2	240	1658/1	191
1377/8/T	30	1385/13	166	1393/18	225	1408/6	244	1413/4	240	1658/2	191
1377/9/T	30	1385/14	166	1393/19	225	1408/7	244	1413/5	240	1659/1	188
1377/10/T	30	1385/15	175	1393/23	226	1408/8	244	1413/6	240	1665/1	212
1377/14/T	30	1385/16	175	1393/24	226	1408/9	244	1413/7	240	1665/2	212
1377/15/T	30	1385/17	175	1393/25	225	1408/10	244	1413/8	240	1665/3	212
1377/16/T	30	1386/1	180	1393/26	225	1408/11	244	1413/9	240	1665/4	212
1377/17/T	30	1386/2	180	1393/27	225	1408/12	244	1413/10	240	1665/5	212
1377/18/T	30	1386/3	180	1393/28	225	1408/13	244	1413/11	240	1665/6	212
1377/20/T	30	1386/4	180	1394/2	218	1408/14	244	1413/12	240	1665/7	212
1377/21/T	30	1386/5	178	1394/3	218	1408/15	244	1413/13	240	1665/8	212
1377/22/T	30	1386/6	178	1394/4	218	1408/16	244	1413/14	240	1665/9	212
1377/41/T	30	1386/7	179	1394/6	218	1408/17	244	1413/15	240	1665/10	212
1377/42/T	30	1386/8	179	1394/7	218	1408/18	244	1413/16	240	1665/11	212
1378/1	34	1386/10	179	1394/8	218	1408/19	244	1413/17	240	1665/12	212
1378/2	32	1386/11	178	1394/9	218	1408/20	244	1413/18	240	1665/13	212
1378/3	34	1386/12	178	1394/10	218	1408/21	244	1413/19	240	1665/14	212
1378/4	34	1386/13	178	1394/11	218	1409/1	239	1413/20	240	1665/15	212
1378/5	34	1387/1	179	1394/12	218	1409/2	239	1413/21	240	1665/16	212
1378/6	32	1387/2	179	1394/13	218	1409/3	239	1413/22	240	1665/17	212
1378/7	34	1387/3	179	1394/14	218	1409/4	239	1413/23	240	1665/18	212
1378/8	34	1389/1	220	1394/15	218	1409/5	239	1413/24	240	1667/2	188
1378/9	32	1389/2	220	1394/16	218	1409/6	239	1413/25	240	1670/1	106
1378/10	34	1389/3	220	1394/17	218	1410/1	239	1413/26	240	1670/2	106
1378/11	32	1389/4	220	1394/18	218	1410/2	239	1414/1	240	1671/1	106
1378/12	34	1389/5	220	1394/19	218	1410/3	239	1414/2	240	1671/2	106
1378/13	34	1389/6	220	1394/20	218	1410/4	239	1414/3	240	1671/3	106
1378/14	34	1391/1	228	1394/21	218	1410/5	239	1414/4	240	1671/4	106
1378/15	32	1391/2	228	1394/22	218	1410/6	239	1414/5	240	1671/6	106
1378/16	34	1391/3	228	1394/23	218	1411/1	239	1414/6	240	1678/2	111
1378/17	34	1391/4	228	1394/24	218	1411/2	239	1414/7	240	1680/2	137
1378/18	32	1391/5	228	1394/25	218	1411/3	239	1414/8	240	1681/1	137
1378/2/S	32	1391/6	228	1395/1	218	1411/4	239	1414/9	240	1682/1	142
1378/5/S	26	1391/7	228	1395/2	218	1411/5	239	1414/10	240	1685/3	144
1378/14/S	26	1391/8	228	1395/3	218	1411/6	239	1414/12	240	1688/3	98
1378/11/S1	32	1391/9	228	1395/4	218	1411/7	239	1414/13	240	1688/4	98
1380/1	176	1391/10	228	1395/5	218	1411/8	239	1414/14	240	1695/1	98

Not all of the Arterferro items are available in **Arterferro Quick**, just a special selection.

Find out about the entire range in the catalogue

In **Arterferro Quick** non sono presenti tutti gli articoli Arterferro, ma solo una speciale selezione.

Scopri la gamma completa nel catalogo

*Compendium*

INDEX - INDICE

1695/2	98	1709/10	82	1716/11	83	1724/31	100	1729/7	88	1757/9	162
1695/3	98	1709/11	82	1716/12	83	1724/32	100	1729/8	88	1757/10	162
1695/4	98	1709/12	82	1716/13	82	1724/33	100	1729/11	88	1757/11	162
1695/5	98	1709/13	87	1716/14	82	1724/34	100	1729/12	88	1757/12	162
1695/6	98	1709/14	87	1716/15	82	1724/35	100	1730/1	89	1757/13	162
1701/1	82	1709/15	87	1716/16	82	1724/36	100	1730/2	89	1757/14	162
1701/2	82	1709/16	87	1716/17	82	1724/37	100	1730/3	89	1757/15	162
1701/3	82	1709/17	87	1716/18	82	1724/38	100	1730/4	89	1757/16	162
1701/5	82	1709/18	87	1716/19	82	1724/39	100	1730/5	89	1757/17	162
1701/7	82	1709/19	87	1716/20	82	1724/40	100	1730/6	89	1757/18	162
1701/8	82	1709/20	87	1716/21	82	1724/41	100	1730/7	89	1757/19	162
1701/9	82	1709/21	87	1716/22	82	1724/42	100	1730/8	89	1757/20	162
1701/10	82	1709/22	82	1716/23	82	1724/43	100	1730/9	88	1757/21	162
1701/11	82	1709/23	87	1716/24	82	1724/44	100	1730/10	88	1757/22	162
1701/12	82	1709/24	82	1718/1	90	1724/45	100	1730/11	88	1757/23	162
1701/13	156	1710/1	83	1718/2	90	1724/46	100	1730/12	88	1757/24	162
1701/14	82	1710/2	83	1718/3	90	1724/47	100	1730/13	88	1757/25	162
1701/15	82	1710/3	83	1718/4	90	1724/48	100	1730/14	88	1757/26	162
1702/1	87	1710/4	82	1718/5	90	1724/49	100	1730/15	88	1757/27	162
1702/2	87	1710/5	83	1718/6	90	1724/50	100	1730/16	88	1757/28	162
1702/3	87	1710/7	83	1718/7	90	1724/51	100	1730/17	88	1757/29	162
1702/4	87	1710/8	83	1718/8	90	1724/52	100	1733/1	83	1757/30	162
1702/5	87	1710/9	83	1718/9	90	1724/53	100	1733/2	83	1757/31	162
1702/6	87	1710/10	83	1718/10	90	1724/54	100	1733/4	83	1757/32	162
1702/7	87	1710/11	83	1718/11	90	1724/55	100	1733/5	87	1757/33	162
1702/8	87	1710/12	83	1718/12	90	1724/56	100	1733/6	87	1757/34	162
1702/9	87	1710/13	82	1718/13	90	1724/57	100	1733/7	87	1757/35	162
1702/10	87	1710/14	82	1718/14	90	1724/58	100	1733/8	87	1757/36	162
1702/11	87	1710/17	82	1718/15	90	1724/59	100	1733/9	82	1757/37	162
1702/12	87	1710/19	82	1718/16	90	1724/60	100	1733/11	82	1757/38	162
1702/13	87	1710/20	82	1718/17	90	1724/61	100	1733/12	82	1757/39	162
1702/14	87	1710/21	82	1722/1	170	1724/62	100	1733/13	88	1757/40	162
1702/15	87	1710/23	82	1722/2	170	1725/1	100	1733/14	88	1757/41	162
1705/1	83	1713/1	87	1722/3	170	1725/2	100	1733/15	88	1757/42	162
1705/2	83	1713/2	87	1722/4	170	1725/3	100	1733/16	88	1757/43	162
1705/3	83	1713/3	87	1723/3	94	1725/4	100	1733/17	102	1757/44	162
1705/4	83	1713/4	87	1723/4	94	1725/5	100	1733/18	102	1757/45	162
1705/5	83	1713/5	87	1724/1	100	1725/6	100	1733/19	102	1757/49	162
1705/6	83	1713/6	87	1724/2	100	1725/7	100	1733/20	102	1757/50	162
1705/7	83	1713/7	87	1724/3	100	1725/8	100	1734/1	86	1757/51	162
1705/8	83	1713/8	87	1724/4	100	1725/9	100	1734/2	86	1757/52	162
1705/9	83	1713/9	87	1724/5	100	1725/10	100	1746/1	91	1757/53	162
1705/10	83	1713/10	87	1724/6	100	1725/11	100	1746/2	91	1757/54	162
1705/11	83	1713/11	87	1724/7	100	1725/12	100	1746/3	91	1757/55	162
1705/12	83	1713/12	87	1724/8	100	1725/13	100	1746/4	91	1757/56	162
1705/13	156	1714/1	87	1724/9	100	1725/14	100	1746/5	91	1757/57	162
1705/14	83	1714/2	87	1724/10	100	1725/15	100	1746/6	91	1757/58	162
1705/15	83	1714/3	87	1724/11	100	1725/16	100	1749/9	80	1757/59	162
1707/1	83	1714/4	87	1724/12	100	1725/17	100	1749/10	80	1757/60	162
1707/2	83	1714/5	87	1724/13	100	1725/18	100	1749/11	80	1757/61	162
1707/3	83	1714/6	87	1724/14	100	1725/19	100	1749/12	80	1757/62	162
1707/4	83	1714/7	87	1724/15	100	1725/20	100	1751/5	95	1757/63	162
1707/5	83	1714/8	87	1724/16	100	1725/21	100	1753/1	97	1757/64	162
1707/6	83	1714/9	87	1724/17	100	1725/22	100	1753/2	110	1757/65	162
1707/7	83	1714/10	87	1724/18	100	1725/23	100	1753/6	111	1757/66	162
1707/8	83	1714/11	87	1724/19	100	1725/24	100	1753/7	97	1757/67	162
1707/9	83	1714/12	87	1724/20	100	1727/1	88	1754/45	176	1757/68	162
1707/10	83	1716/1	83	1724/21	100	1727/2	88	1754/46	176	1757/69	162
1707/11	83	1716/2	83	1724/22	100	1727/3	88	1754/47	176	1757/70	162
1707/12	83	1716/3	83	1724/23	100	1727/4	88	1757/1	162	1757/71	162
1709/1	82	1716/4	83	1724/24	100	1727/7	88	1757/2	162	1757/72	162
1709/2	82	1716/5	83	1724/25	100	1727/8	88	1757/3	162	1757/73	162
1709/3	82	1716/6	83	1724/26	100	1729/1	88	1757/4	162	1757/74	162
1709/5	82	1716/7	83	1724/27	100	1729/2	88	1757/5	162	1757/75	162
1709/7	82	1716/8	83	1724/28	100	1729/3	88	1757/6	162	1757/76	162
1709/8	82	1716/9	83	1724/29	100	1729/4	88	1757/7	162	1757/77	162
1709/9	82	1716/10	83	1724/30	100	1729/6	88	1757/8	162	1757/78	162

Not all of the Arteferro items are available in **Arteferro Quick**, just a special selection.

Find out about the entire range in the catalogue

In **Arteferro Quick** non sono presenti tutti gli articoli Arteferro, ma solo una speciale selezione.

Scopri la gamma completa nel catalogo

# Compendium

## INDEX - INDICE

1758/1	162	1764/4	169	1764/71	169	1770/8	79	1783/2	152	1802/38	194
1758/2	162	1764/5	169	1764/72	169	1770/9	74	1783/3	152	1802/39	194
1758/3	162	1764/6	169	1764/73	169	1770/10	74	1783/4	152	1802/40	194
1758/4	162	1764/7	169	1764/74	169	1770/11	76	1783/5	152	1802/41	194
1758/5	162	1764/8	169	1764/75	169	1770/12	76	1783/6	152	1802/42	194
1758/6	162	1764/9	169	1764/76	169	1770/13	78	1783/7	152	1802/43	194
1758/7	162	1764/10	169	1764/77	169	1770/14	78	1784/1	155	1802/44	194
1758/8	162	1764/11	169	1764/78	169	1770/15	78	1784/2	155	1802/45	194
1758/9	162	1764/12	169	1764/79	169	1770/16	78	1784/3	155	1802/46	194
1758/10	162	1764/13	169	1764/80	169	1771/1	73	1784/4	155	1802/47	194
1758/11	162	1764/14	169	1764/81	169	1771/2	72	1784/5	156	1802/48	194
1758/12	162	1764/15	169	1764/82	169	1771/3	72	1784/6	156	1802/49	194
1758/13	162	1764/16	169	1764/83	169	1771/5	75	1784/9	156	1802/50	194
1758/14	162	1764/17	169	1764/84	169	1771/8	79	1784/7/S	156	1802/51	194
1758/15	162	1764/18	169	1764/85	169	1773/1	79	1785/1	160	1802/52	194
1758/16	162	1764/19	169	1764/86	169	1773/2	79	1785/5	160	1802/53	194
1758/17	162	1764/20	169	1764/87	169	1773/5	79	1787/4	159	1802/54	194
1758/18	162	1764/21	169	1764/88	169	1773/6	79	1787/9	159	1802/55	194
1758/19	162	1764/22	169	1764/89	169	1775/1	81	1789/3	159	1802/56	194
1758/20	162	1764/23	169	1764/90	169	1775/2	81	1789/4	159	1802/57	194
1758/21	162	1764/24	169	1764/91	169	1775/6	81	1793/7	222	1802/58	194
1758/22	162	1764/25	169	1764/92	169	1775/7	88	1793/8	222	1802/59	194
1758/23	162	1764/26	169	1764/93	169	1775/8	88	1794/3	93	1802/60	194
1758/24	162	1764/27	169	1764/94	169	1775/11	81	1794/4	93	1802/61	194
1758/25	162	1764/28	169	1764/95	169	1775/12	81	1794/5	93	1802/62	194
1758/26	162	1764/29	169	1764/96	169	1777/1	83	1794/6	93	1802/63	194
1758/27	162	1764/30	169	1764/97	169	1777/2	82	1794/9	37	1802/64	194
1758/28	162	1764/31	169	1764/98	169	1777/3	87	1794/9/6000	37	1802/65	194
1758/29	162	1764/32	169	1764/99	169	1777/4	83	1794/10	37	1802/66	194
1758/30	162	1764/33	169	1764/100	169	1777/5	87	1794/10/6000	37	1802/67	194
1758/31	162	1764/34	169	1764/101	169	1777/6	82	1802/1	194	1802/68	194
1758/32	162	1764/35	169	1764/102	169	1777/7	82	1802/2	194	1802/69	194
1758/33	162	1764/36	169	1765/2	175	1777/8	87	1802/3	194	1802/70	194
1758/34	162	1764/37	169	1765/3	175	1777/9	83	1802/4	194	1802/71	194
1758/35	162	1764/38	169	1765/4	175	1779/7	157	1802/5	194	1802/72	194
1758/36	162	1764/39	169	1765/11	175	1779/8	157	1802/6	194	1802/73	194
1758/37	162	1764/40	169	1765/16	175	1779/9	83	1802/7	194	1802/74	194
1758/38	162	1764/41	169	1765/21	175	1779/10	83	1802/8	194	1802/75	194
1758/39	162	1764/42	169	1765/26	175	1779/11	87	1802/9	194	1802/76	194
1758/40	162	1764/43	169	1765/31	175	1779/12	87	1802/10	194	1802/77	194
1758/41	162	1764/44	169	1765/36	175	1779/13	82	1802/11	194	1802/78	194
1758/42	162	1764/45	169	1765/41	175	1779/14	82	1802/12	194	1802/79	194
1758/43	162	1764/46	169	1765/46	175	1779/15	157	1802/13	194	1802/80	194
1758/44	162	1764/47	169	1765/51	175	1779/16	157	1802/14	194	1802/81	194
1758/45	162	1764/48	169	1766/33	176	1780/1	83	1802/15	194	1802/82	194
1758/46	162	1764/49	169	1766/34	176	1780/2	83	1802/16	194	1802/83	194
1758/47	162	1764/50	169	1766/35	176	1780/3	87	1802/17	194	1802/84	194
1758/48	162	1764/51	169	1766/36	176	1780/4	87	1802/18	194	1802/85	194
1758/49	162	1764/52	169	1766/37	176	1780/5	82	1802/19	194	1802/86	194
1758/50	162	1764/53	169	1766/38	176	1780/6	82	1802/20	194	1802/87	194
1758/51	162	1764/54	169	1766/39	176	1780/7	157	1802/21	194	1802/88	194
1758/52	162	1764/55	169	1766/40	176	1780/8	157	1802/22	194	1802/89	194
1758/53	162	1764/56	169	1766/41	176	1780/9	83	1802/23	194	1802/90	194
1758/54	162	1764/57	169	1766/42	176	1780/10	83	1802/24	194	1802/91	194
1758/55	162	1764/58	169	1766/43	176	1780/11	87	1802/25	194	1802/92	194
1758/56	162	1764/59	169	1766/44	176	1780/12	87	1802/26	194	1802/93	194
1758/57	162	1764/60	169	1769/1	75	1780/13	82	1802/27	194	1802/94	194
1758/58	162	1764/61	169	1769/2	75	1780/14	82	1802/28	194	1802/95	194
1758/59	162	1764/62	169	1769/3	75	1780/15	157	1802/29	194	1802/96	194
1758/60	162	1764/63	169	1769/5	75	1780/16	157	1802/30	194	1802/97	194
1758/61	162	1764/64	169	1769/6	75	1782/1	155	1802/31	194	1802/98	194
1759/45	176	1764/65	169	1769/7	78	1782/2	155	1802/32	194	1802/99	194
1759/46	176	1764/66	169	1769/8	78	1782/3	155	1802/33	194	1802/100	194
1759/47	176	1764/67	169	1770/1	73	1782/4	155	1802/34	194	1802/101	194
1764/1	169	1764/68	169	1770/2	72	1782/5	155	1802/35	194	1802/102	194
1764/2	169	1764/69	169	1770/3	72	1782/9	155	1802/36	194	1802/103	194
1764/3	169	1764/70	169	1770/5	75	1783/1	152	1802/37	194	1802/104	194

Not all of the Arterferro items are available in **Arterferro Quick**, just a special selection.

Find out about the entire range in the catalogue

In **Arterferro Quick** non sono presenti tutti gli articoli Arterferro, ma solo una speciale selezione.

Scopri la gamma completa nel catalogo

*Compendium*

INDEX - INDICE

1802/105	194	1807/19	36	1819/27	26	1825/25	31	1839/2	22	1839/18/S6000	22
1802/106	194	1807/20	36	1819/28	26	1825/27	31	1839/3	22	1839/20/S6000	22
1802/107	194	1807/21	36	1819/29	26	1825/28	31	1839/4	22	1839/20/S3/6000	22
1802/108	194	1807/22	36	1819/30	26	1827/1	64	1839/5	23	1841/1	20
1802/109	194	1807/23	36	1819/13/S	26	1827/3	64	1839/6	23	1841/2	20
1802/110	194	1807/24	36	1819/17/S	26	1827/5	64	1839/7	23	1841/3	20
1802/111	194	1813/1	238	1819/20/S	26	1827/7	64	1839/8	23	1841/4	20
1802/112	194	1813/2	238	1819/24/S	26	1827/9	64	1839/9	23	1841/5	20
1802/113	194	1813/6	238	1819/28/S	26	1827/11	64	1839/10	23	1841/6	20
1802/114	194	1814/2	29	1819/24/S1	26	1834/1	35	1839/11	23	1841/7	20
1802/115	194	1814/3	27	1819/24/S2	26	1834/2	35	1839/12	23	1841/30	20
1803/1	195	1814/4	27	1819/28/S1	26	1834/3	35	1839/13	23	1841/31	20
1803/2	195	1814/5	27	1820/1	30	1834/4	35	1839/14	23	1841/32	20
1803/3	195	1814/6	27	1820/2	30	1834/5	35	1839/15	22	1841/33	20
1803/4	194	1814/8	29	1820/3	30	1834/6	35	1839/16	22	1841/34	20
1803/5	194	1814/9	27	1820/4	30	1834/7	35	1839/17	22	1841/35	20
1803/6	194	1814/10	27	1820/5	30	1834/8	35	1839/18	22	1841/36	20
1803/7	194	1814/11	27	1820/6	30	1834/9	35	1839/19	22	1845/16	46
1803/8	194	1814/12	27	1820/7	30	1834/1/6000	35	1839/20	22	1845/17	46
1806/1	21	1814/14	29	1820/8	30	1834/2/6000	35	1839/21	22	1845/18	46
1806/2	21	1814/15	27	1820/9	30	1834/3/6000	35	1839/22	22	1845/19	46
1806/3	21	1814/16	27	1820/10	30	1834/4/6000	35	1839/23	22	1845/20	46
1806/4	21	1814/17	27	1820/11	30	1834/5/6000	35	1839/24	22	1845/21	46
1806/5	21	1814/18	27	1820/12	30	1834/6/6000	35	1839/25	35	1845/22	46
1806/6	21	1817/1	26	1820/13	30	1834/7/6000	35	1839/26	22	1845/23	46
1806/7	21	1817/2	26	1820/14	30	1834/8/6000	35	1839/1/S	22	1845/24	46
1806/8	21	1817/3	26	1820/11/XL	30	1834/9/6000	35	1839/14/S	23	1845/25	46
1806/9	21	1817/4	28	1822/1	26	1837/1	35	1839/18/S	22	1845/26	46
1806/10	21	1817/5	26	1822/2	26	1837/2	35	1839/19/S	22	1845/27	46
1806/11	21	1817/7	28	1822/3	26	1837/3	35	1839/18/S1	22	1846/1	59
1806/12	21	1817/8	26	1822/4	26	1837/4	35	1839/18/S2	22	1846/3	41
1806/13	36	1817/9	26	1822/5	28	1837/5	35	1839/18/S3	22	1848/1	38
1806/14	36	1817/9/S5	26	1822/6	28	1837/6	35	1839/18/S4	22	1848/2	38
1806/15	36	1817/9/XL	27	1822/7	28	1837/8	32	1839/19/S1	22	1848/3	38
1806/16	36	1818/1	32	1822/8	28	1837/1/6000	35	1839/20/S1	22	1848/4	38
1806/17	36	1818/2	32	1822/10	31	1837/2/6000	35	1839/20/S2	22	1848/5	38
1806/18	36	1818/3	32	1822/12	26	1837/3/6000	35	1839/20/S3	22	1848/6	38
1806/19	36	1818/4	32	1822/13	26	1837/4/6000	35	1839/20/S4	22	1848/7	39
1806/20	36	1818/5	28	1822/14	26	1837/6/6000	35	1839/1/6000	22	1848/8	39
1806/21	36	1818/6	28	1822/15	26	1838/2	22	1839/2/6000	22	1848/9	39
1806/22	36	1818/7	32	1822/16	28	1838/3	22	1839/3/6000	22	1848/10	39
1806/23	36	1818/8	32	1822/18	28	1838/4	22	1839/4/6000	22	1848/11	39
1806/24	36	1818/9	32	1822/19	28	1838/5	22	1839/5/6000	23	1848/12	39
1806/25	36	1818/10	32	1822/21	31	1838/6	22	1839/6/6000	23	1848/13	39
1806/26	36	1818/11	32	1825/2	33	1838/7	22	1839/7/6000	23	1848/14	39
1806/27	36	1818/12	32	1825/3	33	1838/8	35	1839/8/6000	23	1848/15	39
1806/28	36	1818/13	32	1825/4	33	1838/2/S1	22	1839/9/6000	23	1848/16	39
1806/29	36	1818/14	32	1825/5	33	1838/3/S1	22	1839/10/6000	23	1848/17	39
1806/30	36	1818/15	28	1825/6	33	1838/3/S2	22	1839/11/6000	23	1848/18	39
1807/1	36	1818/16	28	1825/7	33	1838/3/S4	22	1839/12/6000	23	1848/19	39
1807/2	36	1818/11/S	32	1825/8	33	1838/3/S5	22	1839/13/6000	23	1848/20	39
1807/3	36	1819/5	28	1825/9	31	1838/3/S6	22	1839/14/6000	23	1848/21	39
1807/4	36	1819/10	28	1825/10	31	1838/3/S7	22	1839/15/6000	22	1851/1	40
1807/5	36	1819/12	28	1825/11	31	1838/4/S1	22	1839/15/S/L6	22	1851/2	40
1807/6	36	1819/13	26	1825/12	31	1838/2/6000	22	1839/16/6000	22	1851/3	40
1807/7	36	1819/14	26	1825/13	31	1838/3/6000	22	1839/17/6000	22	1851/4	40
1807/8	36	1819/15	26	1825/14	31	1838/4/6000	22	1839/18/6000	22	1851/5	40
1807/9	36	1819/16	26	1825/15	31	1838/5/6000	22	1839/19/50X6	22	1851/6	40
1807/10	36	1819/17	26	1825/16	31	1838/6/6000	22	1839/19/6000	22	1851/7	40
1807/11	36	1819/19	26	1825/17	31	1838/7/6000	22	1839/19/60X6	22	1851/8	40
1807/12	36	1819/20	26	1825/18	31	1838/8/6000	35	1839/20/6000	22	1851/9	40
1807/13	36	1819/21	26	1825/19	31	1838/4/S1/L6	22	1839/21/6000	22	1851/10	40
1807/14	36	1819/22	26	1825/20	31	1838/2/S/3000	22	1839/22/6000	22	1851/11	40
1807/15	36	1819/23	26	1825/21	31	1838/2/S/6000	22	1839/23/6000	22	1851/12	40
1807/16	36	1819/24	26	1825/22	31	1838/5/S/6000	22	1839/24/6000	22	1851/13	40
1807/17	36	1819/25	26	1825/23	31	1838/2/S1/6000	22	1839/26/6000	22	1851/14	41
1807/18	36	1819/26	26	1825/24	31	1839/1	22	1839/1/S/6000	22	1851/15	41

Not all of the Arteferro items are available in **Arteferro Quick**, just a special selection.

Find out about the entire range in the catalogue

In **Arteferro Quick** non sono presenti tutti gli articoli Arteferro, ma solo una speciale selezione.

Scopri la gamma completa nel catalogo

*Compendium*

INDEX - INDICE

1851/16	41	1852/53	53	1853/16	49	1853/83	50	1853/150	48	1853/218	51
1851/18	41	1852/54	53	1853/17	49	1853/84	50	1853/151	48	1853/219	51
1851/18/S1	41	1852/55	53	1853/18	49	1853/85	50	1853/152	48	1853/220	51
1851/19	41	1852/56	53	1853/19	49	1853/86	50	1853/153	48	1853/221	51
1851/20	41	1852/57	53	1853/20	49	1853/87	50	1853/154	48	1853/222	51
1851/21	41	1852/58	53	1853/21	49	1853/88	50	1853/155	48	1853/223	51
1851/22	41	1852/59	53	1853/22	49	1853/89	50	1853/156	48	1853/224	51
1851/23	41	1852/60	53	1853/23	49	1853/90	50	1853/157	48	1853/225	51
1851/24	41	1852/61	53	1853/24	49	1853/91	50	1853/158	48	1853/226	51
1851/25	41	1852/62	53	1853/25	49	1853/92	50	1853/159	51	1853/227	51
1851/26	40	1852/63	53	1853/26	49	1853/93	50	1853/160	51	1853/228	51
1851/27	40	1852/64	53	1853/27	49	1853/94	50	1853/161	51	1853/229	51
1851/28	40	1852/65	53	1853/28	49	1853/95	50	1853/162	51	1853/230	51
1851/29	40	1852/66	53	1853/29	49	1853/96	50	1853/163	51	1854/1	226
1851/30	40	1852/67	53	1853/30	49	1853/97	50	1853/164	51	1854/2	226
1852/1	56	1852/68	53	1853/31	49	1853/98	50	1853/165	51	1854/3	226
1852/2	56	1852/69	53	1853/32	49	1853/99	50	1853/166	51	1854/7	174
1852/3	56	1852/70	53	1853/33	49	1853/100	50	1853/167	51	1854/8	174
1852/4	56	1852/71	53	1853/34	49	1853/101	50	1853/168	51	1854/9	174
1852/5	56	1852/72	53	1853/35	49	1853/102	50	1853/169	51	1854/10	174
1852/6	56	1852/73	53	1853/36	49	1853/103	50	1853/170	51	1855/1	179
1852/7	56	1852/74	53	1853/37	49	1853/104	50	1853/171	51	1855/2	179
1852/8	56	1852/75	53	1853/38	49	1853/105	48	1853/172	51	1855/3	179
1852/9	56	1852/76	53	1853/39	49	1853/106	48	1853/173	51	1855/4	179
1852/10	56	1852/77	53	1853/40	49	1853/107	48	1853/174	51	1855/5	179
1852/11	56	1852/78	53	1853/41	49	1853/108	48	1853/175	51	1855/8	178
1852/12	56	1852/79	53	1853/42	49	1853/109	48	1853/176	51	1855/9	178
1852/13	56	1852/80	53	1853/43	49	1853/110	48	1853/177	51	1855/10	178
1852/14	56	1852/81	53	1853/44	49	1853/111	48	1853/178	51	1855/11	171
1852/15	56	1852/82	53	1853/45	49	1853/112	48	1853/179	51	1855/12	171
1852/16	56	1852/83	53	1853/46	49	1853/113	48	1853/180	51	1855/13	171
1852/17	56	1852/84	53	1853/47	49	1853/114	48	1853/181	51	1855/14	171
1852/18	56	1852/85	53	1853/48	49	1853/115	48	1853/182	51	1855/17	171
1852/19	56	1852/86	53	1853/49	49	1853/116	48	1853/183	51	1855/18	171
1852/20	56	1852/87	53	1853/50	49	1853/117	48	1853/184	51	1855/19	171
1852/21	56	1852/88	53	1853/51	50	1853/118	48	1853/185	51	1855/20	171
1852/22	56	1852/89	53	1853/52	50	1853/119	48	1853/186	51	1855/21	171
1852/23	56	1852/90	53	1853/53	50	1853/120	48	1853/187	51	1855/22	171
1852/24	56	1852/91	53	1853/54	50	1853/121	48	1853/188	51	1855/23	171
1852/25	56	1852/92	53	1853/55	50	1853/122	48	1853/189	51	1855/24	171
1852/26	56	1852/93	53	1853/56	50	1853/123	48	1853/190	51	1855/25	171
1852/27	56	1852/94	53	1853/57	50	1853/124	48	1853/191	51	1855/26	171
1852/28	56	1852/95	53	1853/58	50	1853/125	48	1853/192	51	1857/2	245
1852/29	56	1852/96	53	1853/59	50	1853/126	48	1853/193	51	1857/3	245
1852/30	56	1852/97	53	1853/60	50	1853/127	48	1853/194	51	1857/4	245
1852/31	56	1852/98	53	1853/61	50	1853/128	48	1853/195	51	1857/5	245
1852/32	56	1852/99	53	1853/62	50	1853/129	48	1853/196	51	1857/6	245
1852/33	56	1852/100	53	1853/63	50	1853/130	48	1853/197	51	1857/7	245
1852/34	56	1852/101	53	1853/64	50	1853/131	48	1853/198	51	1857/8	245
1852/35	56	1852/102	53	1853/65	50	1853/132	48	1853/199	51	1857/13	245
1852/36	56	1852/103	53	1853/66	50	1853/133	48	1853/201	51	1857/14	245
1852/37	56	1852/104	53	1853/67	50	1853/134	48	1853/202	51	1857/15	245
1852/38	56	1853/1	49	1853/68	50	1853/135	48	1853/203	51	1858/1	183
1852/39	56	1853/2	49	1853/69	50	1853/136	48	1853/204	51	1858/2	183
1852/40	56	1853/3	49	1853/70	50	1853/137	48	1853/205	51	1858/4	183
1852/41	53	1853/4	49	1853/71	50	1853/138	48	1853/206	51	1858/6	183
1852/42	53	1853/5	49	1853/72	50	1853/139	48	1853/207	51	1860/1	244
1852/43	53	1853/6	49	1853/73	50	1853/140	48	1853/208	51	1860/2	244
1852/44	53	1853/7	49	1853/74	50	1853/141	48	1853/209	51	1860/3	244
1852/45	53	1853/8	49	1853/75	50	1853/142	48	1853/210	51	1860/4	244
1852/46	53	1853/9	49	1853/76	50	1853/143	48	1853/211	51	1860/5	244
1852/47	53	1853/10	49	1853/77	50	1853/144	48	1853/212	51	1860/6	244
1852/48	53	1853/11	49	1853/78	50	1853/145	48	1853/213	51	1861/1	244
1852/49	53	1853/12	49	1853/79	50	1853/146	48	1853/214	51	1861/2	244
1852/50	53	1853/13	49	1853/80	50	1853/147	48	1853/215	51	1861/3	244
1852/51	53	1853/14	49	1853/81	50	1853/148	48	1853/216	51	1861/4	244
1852/52	53	1853/15	49	1853/82	50	1853/149	48	1853/217	51	1861/5	244



Not all of the Arteferro items are available in **Arteferro Quick**, just a special selection.

Find out about the entire range in the catalogue

In **Arteferro Quick** non sono presenti tutti gli articoli Arteferro, ma solo una speciale selezione.

Scopri la gamma completa nel catalogo

*Compendium*

INDEX - INDICE

1861/6	244	F06920	246	GD92/2	130	GD124/38	21	GD271/2	70	GD303/1	121
1861/7	244	F06921	246	GD92/3	130	GD148/1	146	GD271/3	70	GD303/2	121
1861/8	244	F06922	246	GD99/1	143	GD150/2	146	GD271/5	147	GD303/3	121
1861/9	244	F06923	246	GD106/1	95	GD150/3	146	GD273/9	156	NEW0009	112
1861/10	244	F011971	247	GD106/2	95	GD151/1	146	GD273/10	156	NEW0011	112
1861/11	244	F011974	247	GD106/3	95	GD151/2	190	GD274/9	156	NEW0016	112
1861/12	244	F011976	247	GD106/4	95	GD154/3	149	GD274/11	156	NEW0049	245
1861/13	244	F083500	246	GD106/5	95	GD158/1	150	GD275/1	91	NEW0050	245
1861/14	244	F083510	246	GD106/6	95	GD158/2	150	GD275/2	91	NEW0051	245
1861/17	244	F083520	246	GD106/7	95	GD163/1	145	GD275/3	91	NEW0052	245
1861/18	244	F083600	246	GD106/8	95	GD163/2	143	GD275/5	96	NEW0054	245
1861/19	244	F083610	246	GD106/9	95	GD164/1	147	GD275/7	91	NEW0055	245
1861/20	244	F083620	246	GD106/10	95	GD164/2	147	GD275/8	91	NEW0077	63
1861/21	244	F085500	246	GD106/11	95	GD175/1	145	GD275/9	91	NEW0078	63
1861/22	244	F085510	246	GD106/12	95	GD175/2	145	GD282/2	144	NEW0079	64
1861/16/S	244	F085600	246	GD106/13	95	GD175/3	145	GD284/1	141	NEW0080	64
1905/1	264	F085610	246	GD106/14	95	GD175/4	145	GD285/1	135	NEW0081	64
1905/2	264	F085700	246	GD106/15	95	GD175/5	145	GD285/2	134	NEW0082	64
1905/3	264	F085710	246	GD106/16	95	GD175/6	145	GD285/3	134		
1905/4	264	F085720	246	GD106/17	95	GD175/7	150	GD285/4	134		
1905/5	264	GD13/1	104	GD106/18	95	GD176/3	129	GD285/5	134		
1905/6	264	GD16/1	137	GD106/19	95	GD181/1	115	GD285/2/S	135		
1905/7	264	GD16/2	137	GD106/20	95	GD181/2	115	GD286/1	134		
1905/8	264	GD18/1	137	GD106/21	95	GD181/3	115	GD287/1	116		
1905/9	264	GD18/2	137	GD106/22	95	GD182/1	115	GD287/2	116		
1905/10	264	GD19/1	114	GD106/23	95	GD182/2	115	GD287/3	116		
1905/12	264	GD19/2	114	GD106/24	95	GD183/1	115	GD287/4	116		
1905/13	264	GD20/1	138	GD106/25	95	GD184/1	115	GD288/1	123		
1905/14	264	GD20/2	138	GD106/26	95	GD184/2	115	GD289/1	122		
1905/15	264	GD20/3	138	GD106/27	95	GD187/1	136	GD289/2	122		
1905/16	264	GD20/4	138	GD124/1	46	GD187/2	136	GD289/1/S	122		
1905/17	264	GD20/5	138	GD124/2	46	GD189/2	136	GD289/2/S	122		
1905/18	264	GD20/6	138	GD124/3	46	GD205/1	135	GD290/1	125		
1905/19	264	GD20/7	128	GD124/4	46	GD205/2	135	GD290/2	125		
5069/3	258	GD20/8	138	GD124/5	46	GD209/1	135	GD291/1	135		
6112/4/S	55	GD21/1	139	GD124/6	46	GD211/1	140	GD291/2	132		
10301/1	258	GD21/2	139	GD124/7	46	GD211/2	140	GD293/1	117		
10301/2	258	GD21/3	139	GD124/8	46	GD211/3	140	GD293/2	127		
10314/1	258	GD21/4	139	GD124/9	45	GD211/4	140	GD293/3	122		
10314/2	258	GD21/5	139	GD124/10	45	GD212/1	140	GD293/3/S	122		
10314/3	258	GD21/6	139	GD124/11	45	GD219/1	143	GD294/1	123		
10314/4	258	GD22/1	144	GD124/12	45	GD220/1	149	GD294/2	123		
10315/1	258	GD22/3	145	GD124/13	45	GD222/1	129	GD294/3	123		
10315/2	258	GD22/6	95	GD124/14	45	GD222/2	129	GD294/1/S	123		
10315/3	258	GD22/6/S	95	GD124/15	45	GD223/1	129	GD294/2/S	123		
10315/6	258	GD23/1	114	GD124/16	45	GD228/2	147	GD294/3/S	123		
10316/1	258	GD25/1	114	GD124/17	20	GD232/1	142	GD295/1	126		
F060	246	GD25/3	114	GD124/18	20	GD234/1	137	GD295/2	126		
F061	246	GD31/1	142	GD124/19	20	GD235/1	148	GD296/1	127		
F062	246	GD31/2	142	GD124/20	20	GD236/1	143	GD296/2	127		
F063	246	GD35/1	141	GD124/21	20	GD242/1	142	GD297/1	124		
F064	246	GD35/2	141	GD124/22	20	GD243/2	114	GD297/2	124		
F065	246	GD35/3	141	GD124/23	20	GD248/1	75	GD298/1	124		
F066	246	GD39/3	147	GD124/24	20	GD248/2	75	GD298/2	124		
F069	246	GD43/1	128	GD124/25	20	GD248/4	75	GD299/1	118		
F0181	246	GD45/1	128	GD124/26	20	GD262/1	210	GD299/2	118		
F0222	247	GD45/2	128	GD124/27	20	GD262/2	210	GD299/3	118		
F0223	247	GD58/2	114	GD124/28	20	GD262/3	210	GD299/4	118		
F0631	246	GD58/3	114	GD124/29	20	GD262/4	210	GD300/1	133		
F0681	246	GD59/2	114	GD124/30	20	GD263/1	210	GD300/2	133		
F0682	246	GD59/2/Q14	114	GD124/31	20	GD263/2	210	GD300/3	133		
F01197	247	GD61/1	141	GD124/32	20	GD263/3	210	GD301/1	117		
F02231	247	GD68/1	140	GD124/33	21	GD268/1	188	GD301/2	117		
F06910	246	GD68/2	138	GD124/34	21	GD268/2	189	GD301/3	117		
F06911	246	GD73/1	130	GD124/35	21	GD270/2	187	GD302/1	120		
F06912	246	GD76/1	136	GD124/36	21	GD270/5	112	GD302/2	120		
F06913	246	GD76/2	136	GD124/37	21	GD271/1	70	GD302/3	120		



store.arteferro.com



More than 2000 items in just one click  
Più di 2000 articoli in un solo click





Il catalogo, comprese tutte le sue parti, è tutelato dalla legge sui diritti d'autore. Sono vietate e sanzionate (se non espressamente autorizzate) la riproduzione in ogni modo e forma (comprese le fotocopie, la scansione, la memorizzazione elettronica) e la comunicazione (ivi inclusi a titolo esemplificativo ma non esaustivo: la distribuzione, l'adattamento, la traduzione e la rielaborazione, anche a mezzo di canali digitali interattivi e con qualsiasi modalità attualmente nota od in futuro sviluppata)

The catalogue, including all its parts, is under copyright law. Any reproduction in any way and form (including photocopies, scans, electronic storages) and communication (including for example: the distribution, the adjustment, the translation and the revision, also through digital interactive channels and any other mode currently known or developed in future) is forbidden and sanctioned (if not clearly authorised).



Ci riserviamo il diritto di apportare variazioni tecniche di fabbricazione e di dimensioni ai prodotti. I prodotti originali possono differire leggermente dalle rappresentazioni fotografiche. A questo proposito non sarà accettato nessun reclamo.

We reserve the right to make technical changes of the production process and of the article's dimensions.

The original item can slightly differ from its picture. Hence no claims can be accepted in this regard.



Ind.i.a. spa declina ogni responsabilità giuridica non legalmente prevista per eventuali errori di stampa.  
Ind.i.a. spa disclaims any legal liability not legally foreseen for printing mistakes



La somma massima prevista per i risarcimenti e rappresentata dal valore della merce integra.

The max reimbursement amount foreseen as claim for damages is to be referred to the value of intact goods



Si prega di osservare le direttive legali applicabili nelle varie regioni/nei vari paesi.

You are kindly requested to observe the directives applied in the different areas/countries.



I prezzi indicati sono netti per unità, imballaggio incluso. Tutti i prezzi sono IVA esclusa.

The prices are net per unit, packaging included. All prices are exempt of VAT.



Per ogni articolo è prevista una confezione minima indicata a listino. Eventuali ordini per quantità che differiscono dalla confezione minima o a multipli di essa, potranno essere automaticamente adeguati dall'azienda senza previa autorizzazione.

For each item a minimum packaging unit is foreseen, as indicated in the price-list. In case of orders with different quantities than those of the minimum packaging or multiple of it, the company can adjust them automatically without prior authorisation.



Si applicano le nostre condizioni generali di vendita

Our general sales conditions will be applied

Our sales conditions can be read in our website

Le condizioni di vendita le potete trovare sul sito

Condiciones de venta en nuestro sitio web

Conditions de vente dans notre site

[www.gonzatogroup.com/sales\\_conditions.html](http://www.gonzatogroup.com/sales_conditions.html)

**ITALIA - Headquarters**

Ind.i.a. spa  
Via Vicenza, 6/14  
36034 - Malo  
Vicenza • Italia  
tel. +39 0445 580 580 • fax: +39 0445 580 874  
info@india.it • www.india.it

**U.S.A.**

Indital US Ltd  
7947 Mesa Drive  
77028 - Houston  
Texas • U.S.A.  
tel. +1 713 694 6065 • fax: +1 713 694 2055  
forgings@indital.com • www.indital.com

**FLORIDA - CARAIBI**

Arteferro Miami LLC  
2955 NW 75th Street  
33147 - Miami  
Florida • U.S.A.  
tel. +1 305 836 9232 • fax: +1 305 836 4113  
info@arteferromiami.com • www.arteferromiami.com

**ITALIA**

Nuova Co.Ge.Me. srl  
Via Enrico Fermi 34  
26041 - Casalmaggiore  
Cremona • Italia  
tel. +39 0375 284820 • fax: +39 0375 203877  
info@cogemesteel.com

**DEUTSCHLAND**

Triebenbacher Betriebsgesellschaft mbH  
Gutenbergstraße 1  
85737 Ismaning  
Deutschland  
tel. +49 (0) 89/57 09 28 50 • fax: +49 (0) 89/57 09 28 38  
info@triebenbacher.de • www.triebenbacher.de

**FRANCE**

Ind.i.a. France Sarl  
P.A.E. la Baume, 7 Rue de l'Artisanat  
34290 - Servian  
Servian • France  
tel. +33 (0) 4 67 39 42 81 • fax: +33 (0) 4 67 39 20 90  
info@indiafrance.eu • www.indiafrance.eu

**HRVATSKA**

Arteferro Dohomont doo  
Gospodarska 1/A  
40324 - Goričan  
Goričan • Hrvatska  
tel. +385 (0) 40 602 222 • fax: +385 (0) 40 602 230  
info@arteferro-dohomont.hr • www.arteferro-dohomont.hr

**ESPAÑA**

Ind.i.a. España, SL  
C/ Abedul, 43 – Polig. Ind. El Guijar  
28500 - Arganda del Rey  
Madrid • España  
tel. +34 918 700 819 • fax: +34 918 700 820  
info@arteferro.es • www.arteferro.es

**РОССИЯ**

ООО "АРТЕФЕРРО-РУССИЯ"  
603124, Россия, Нижний Новгород, Вторчермета 1Г  
Тел. +7-831-2621999  
info@arteferrorussia.com  
www.arteferro.ru

**УКРАЇНИ**

Arteferro Ukraina  
Автомаркова, 5  
02660 - Киев  
Україна  
tel. +380 44 492 03 31 • fax: +380 44 492 03 32  
office@arteferroukraine.com • www.arteferroukraine.com

**SVERIGE - DANMARK**

Arteferro Skandinavien AB  
Röda Stugans gata 2  
602 28 - Norrköping  
Sverige  
tel. +46 (0) 11 18 23 23 • fax: +46 (0) 11182328  
info@arteferro.se • www.arteferro.se

**MÉXICO**

Arteferro Monterrey SA de CV  
Privada la Puerta 2879 B-4  
66350 - Col. Parque Industrial - La Puerta Santa Catarina  
Nuevo Leon • México  
tel. +52 1 81 1295 5094/95 • fax: +52 1 81 1295 5097  
info@arteferromexico.com • www.arteferromexico.com

**ARGENTINA**

Arteferro Argentina SA  
Suárez 760  
1162 - Buenos Aires  
Argentina  
tel. +54 11 4301 2637 • fax: +54 11 4301 2637  
info@arteferroargentina.com • www.arteferroargentina.com

**CHILE**

Arteferro Chile SA  
Calle Los Arrayanes, 250, bodega 4  
9340000 - Santiago  
Colina • Chile  
tel. +56 2 738 7419 • fax: +56 2 738 7419  
arteferro@arteferrohile.cl • www.arteferrohile.cl

**中华人民共和国**

China (Shandong province)  
Representative Far East  
india@arteferro.com

**BRASIL**

Ind.i.a. Brasil LTDA  
Rua Padre Feijó, 480  
95190-000 - São Marcos  
Rio Grande do Sul • Brasil  
tel. +55 54 3291 1416 • fax: +55 54 3291 1416  
Branch  
Av. Almirante Cochrane, 194 – Sala 32  
11040-200 – Santos - Sao Paulo • Brasil  
tel. +55 13 21389081  
vendas@arteferrobrazil.com.br  
www.arteferrobrazil.com.br



[www.arteferro.com](http://www.arteferro.com)



YouTube

