

*arteferro*



## PRODUCT AND DESIGN CULTURE

The long tradition that characterizes the Group has created a culture of product and design in which simplicity and craftsmanship go hand in hand with high engineering capacity and constant technological innovation.

A perfect combination that can offer functional and aesthetically exclusive solutions in line with the most current architectural and interior design trends.

## CULTURA DI PRODOTTO E PROGETTO

La lunga tradizione che contraddistingue il Gruppo ha creato una cultura del prodotto e del progetto nella quale semplicità e artigianalità vanno di pari passo con un'elevata capacità ingegneristica e una costante innovazione tecnologica.

Un perfetto connubio in grado di offrire soluzioni funzionali ed esteticamente esclusive in linea con le più attuali tendenze architettoniche e di interior design.

**THE GROUP  
IL GRUPPO**

ITALIAN BY BIRTH, INTERNATIONAL BY VOCATION.  
ITALIANI PER NASCITA, INTERNAZIONALI PER VOCAZIONE.



**GONZATO**  
GROUP

ITALY / USA-HOUSTON / USA-MIAMI / USA-LOS ANGELES  
FRANCE / SPAIN / CROATIA / ROMANIA / RUSSIA / MEXICO  
ARGENTINA / CHILE / BRAZIL / CHINA

**arteferro**

**WM**  
DESIGN



# CONTENTS CONTENUTI

4	DALL'ESPERIENZA DI ARTEFERRO - DALL'ESPERIENZA DI ARTEFERRO
5	INTRODUCING THE CERTIFIED ARTEFERRO SYSTEM - NASCE IL SISTEMA CERTIFICATO ARTEFERRO SYSTEM
6	THE APPLICATIONS - LE APPLICAZIONI
7	THE CERTIFIED SYSTEM - IL SISTEMA CERTIFICATO
8	THE SYSTEM   THE STRUCTURE AND THE NEVEL POST - IL SISTEMA   LA STRUTTURA E I MONTANTI
10	IL SISTEMA   LA PINZA CLACK - IL SISTEMA   LA PINZA
12	THE SYSTEM   THE PANELS - IL SISTEMA   I PANNELLI
14	MOD. SIRMIONE
16	MOD. FIRENZE
18	MOD. TRIESTE
20	MOD. ROMA
22	MOD. BOLZANO
24	MOD. ORTIGIA
26	MOD. PORTOFINO
28	MOD. BOLOGNA
30	MOD. STRESA
32	MOD. NAPOLI
34	MOD. VENEZIA
36	MOD. PERUGIA
38	MOD. ASCOLI
40	MOD. TRANI
42	MOD. CAGLIARI
44	MOD. AOSTA
46	MOD. JESOLO
48	MOD. ISEO
50	MOD. TORINO
52	MOD. VICENZA
54	MOD. CORTINA
56	MOD. MILANO
58	MOD. TAORMINA
60	MOD. TROPEA
62	FINISHES AND COLORS - FINITURE E COLORI
63	ACCESSORIES - ACCESSORI
64	THE REGULATIONS - LE NORMATIVE
66	LABORATORY TESTS AND CERTIFICATIONS - TEST DI LABORATORIO E CERTIFICAZIONI

## FROM THE EXPERIENCE OF ARTEFERRO DALL'ESPERIENZA DI ARTEFERRO

Arteferro is the reference brand in the production and commercialization of wrought iron, brass, and bronze ornamental semi-finished products for building and architecture. Its products are of the highest quality, characterized by a design that is in line with the latest housing trends, which combine traditional craftsmanship, industrial efficiency, and the beauty of wrought iron to offer innovative and customized design solutions.

Arteferro è il brand di riferimento nella produzione e commercializzazione di semilavorati ornamentali in ferro battuto, ottone e bronzo per l'edilizia e l'architettura. Prodotti di altissima qualità, caratterizzati da un design in linea con le ultime tendenze dell'abitare, che coniugano la tradizione artigianale, l'efficienza dell'organizzazione industriale e la bellezza del ferro lavorato per offrire soluzioni progettuali innovative e personalizzate.

### Flexible production, quality guaranteed and certified

With three production sites in Italy and Europe, the entire supply chain is managed, ensuring flexibility in the supply and a **very high level of quality** in all phases. It's no coincidence that the **main quality** (ISO 9001), environmental (ISO 14001), manufacturing requirements (UN EN 1090), and product safety certifications have been obtained, even in international markets. Appropriate labels make our products traceable and identify their origin to prevent counterfeiting.

### Produzione flessibile, qualità garantita e certificata

Con tre siti produttivi in Italia ed Europa viene gestita l'intera filiera garantendo flessibilità nella fornitura e un **altissimo** livello di qualità in tutte le fasi. Non è un caso se sono state ottenute le **principali certificazioni** in termini di qualità (ISO 9001), di ambiente (ISO 14001), di requisiti di fabbricazione (UN EN 1090) e di sicurezza dei prodotti anche nei mercati internazionali. **Apposite etichette** rendono i nostri prodotti tracciabili e ne identificano l'origine contro la contraffazione.



### Design and innovation

A team of designers and engineers works daily on the creation of new products, which are easy to assemble and integrate into any context. The **constant research** on lines, shapes, and materials increasingly satisfies the need for beauty in harmony with technical requirements, offering ample possibilities for customization.

### Design e innovazione

Un team di designer ed ingegneri lavora quotidianamente all'ideazione di nuovi prodotti, semplici da assemblare e da integrare in qualsiasi contesto. La **costante ricerca** su linee, forme e materiali soddisfa sempre più la necessità di bellezza in armonia con le esigenze tecniche offrendo ampie possibilità di personalizzazione.

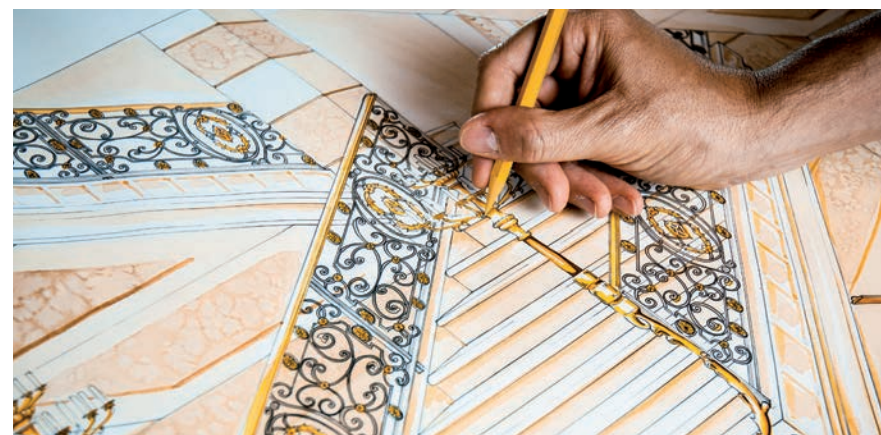

# INTRODUCING THE CERTIFIED ARTEFERRO SYSTEM NASCE IL SISTEMA CERTIFICATO ARTEFERRO SYSTEM



TUTORIAL VIDEOS

## The Idea

To facilitate and speed up the installation of railings, balconies, and fences, we have created an **innovative system** that combines the beauty of our wrought iron semi-finished products with the practicality of a **ready-made module, complete with everything needed** for its composition. Available in **various models and finishes** to offer maximum customization, our systems are certified according to the most stringent regulations and offer complete safety of use. Composed of the upright and the infill panel, they are equipped with an **innovative and patented connecting clamp that does not require screws**. In this way, the work of the professional is simpler and faster.”

## L'idea

Per facilitare e velocizzare l'installazione di parapetti, balconi e recinzioni abbiamo creato un **sistema innovativo** in grado di coniugare la **bellezza** dei nostri semilavorati in ferro con la praticità di un **modulo già pronto, completo di tutto** ciò che serve per la sua composizione. Disponibili in vari modelli e finiture, per offrire la massima personalizzazione, i nostri sistemi sono **certificati** in base alle più stringenti normative e offrono la totale sicurezza di utilizzo. Composti dal montante e dal pannello di tamponamento sono dotati di un'**innovativa e brevettata pinza di raccordo che non necessita di viti**. In questo modo il lavoro del professionista è più semplice e veloce.



SAFETY  
SICUREZZA

DESIGN

EASY INSTALLATION  
FACILITÀ DI INSTALLAZIONE



## THE APPLICATIONS LE APPLICAZIONI

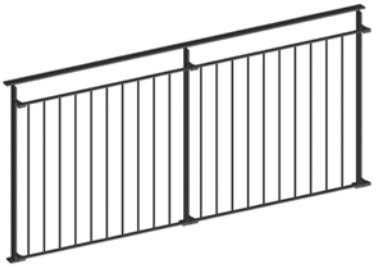

### Railing System

Our certified modular railing system allows you to quickly define any surface exposed to the risk of falling from a height. An **innovative product with modern lines and high-quality finishes**, suitable for both private and public construction, and compliant with current legal regulations. Simply identify the thrust load that the upright must withstand (1 kN or 2kN), choose the model (flat, square or round), coordinate the corresponding handrail and finally match the desired buffer panel, available in a wide range of models and finishes.

### Sistemi di parapetti

Il nostro parapetto modulare certificato consente di delimitare in tempi brevissimi qualsiasi superficie esposta al rischio di caduta dall'alto. Un **prodotto innovativo con linee moderne e finiture di pregio**, adatto sia per l'edilizia privata che pubblica, e conforme alle vigenti normative di legge. Basta identificare il carico di spinta che deve sostenere il montante (1 kN o 2kN), scegliere il modello (piatto, quadrato o tondo), coordinare il relativo corrimano e abbinare infine il pannello di tamponamento desiderato, disponibile in una vasta gamma di modelli e finiture.

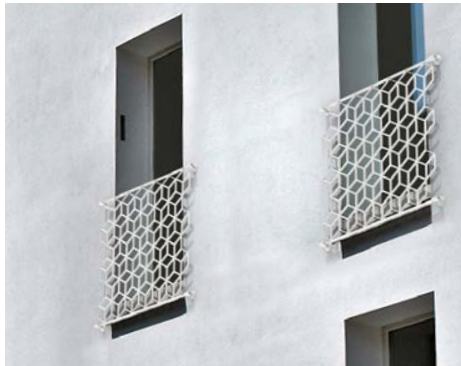

### French Balcony System

A modern closure, capable of meeting the needs of every customer. Ideal for those who need to **secure windows**, turning the opening into a protected space, without compromising the architecture of the building facade. Available in two versions: anchoring to masonry and direct anchoring to the wall with insulation.

### Sistemi di balconi

Una chiusura moderna, capace di rispondere alle esigenze di ogni cliente. Ideale per chi ha necessità di **mettere in sicurezza le finestre**, trasformando l'affaccio in uno spazio protetto, senza compromettere l'architettura della facciata dell'edificio. Disponibile in due versioni: ancoraggio su muratura e ancoraggio diretto su muro con cappotto isolante.



### Fencing System

The natural evolution of modular railings was the creation of a line of modular fences. This system meets all design and construction needs, offering **perfect aesthetic coordination between railings or balconies and external fences**. The wide range of panels, available in two different heights, allows you to create a unique and customized fence.

### Sistemi di recinzioni

La naturale evoluzione dei parapetti modulari è stata la creazione della linea di recinzioni modulari. Questo sistema risponde a tutte le esigenze progettuali e di cantiere, offrendo un **perfetto coordinamento estetico tra parapetti o balconi e le recinzioni esterne**. L'ampia gamma di pannelli, disponibili in due diverse altezze, permette di creare una recinzione unica e personalizzata.



## THE CERTIFIED SYSTEM IL SISTEMA CERTIFICATO

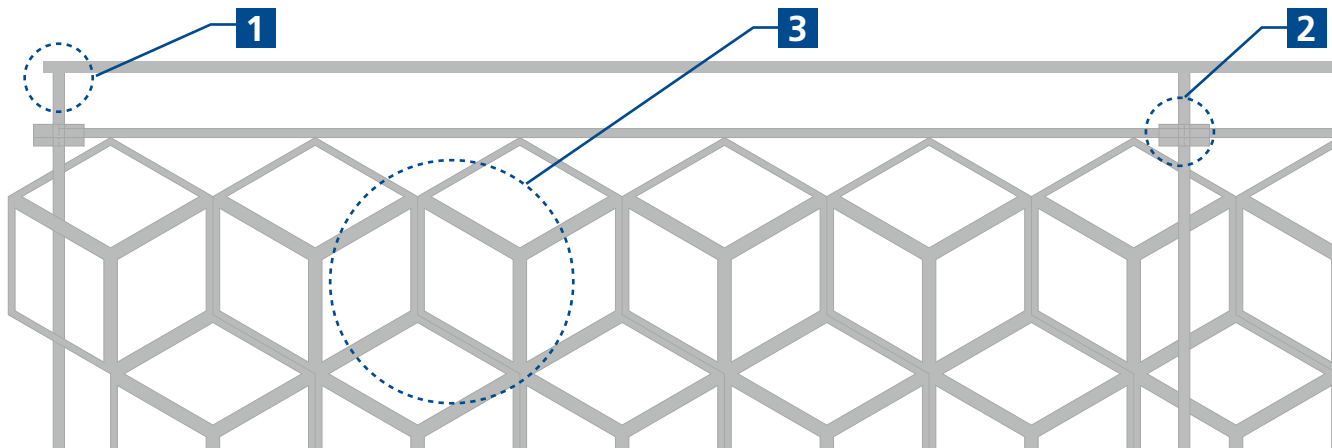

**1**

### The level post

It is the load-bearing and certified structure of our system that ensures its stability. It can withstand load stresses of 1 kN/m and 2 kN/m. Available in flat, round, and square versions.

### Il montante

È la struttura portante e certificata del nostro sistema che ne garantisce la tenuta. Resiste a sollecitazioni di carico di 1 kN/m e 2 kN/m. Disponibile in versione piatta, rotonda e quadrata.



**2**

### The Clack Clamp

A result of our innovative patent, it is the connecting element between the infill panel and the load-bearing structure. It fits all level post models and has been specifically designed to facilitate and speed up installation. It does not require screws and closes with a simple pressure, definitively locking and securing the elements to be joined.

### La pinza Clack

Frutto di un nostro innovativo brevetto, è l'elemento di congiunzione tra il pannello di tamponamento e la struttura portante. Si adatta a tutti i modelli di montante ed è stata appositamente progettata per facilitare e velocizzare l'installazione. Non necessita di viti e si chiude con una semplice pressione bloccando definitivamente e mettendo in totale sicurezza gli elementi da unire.



TO REACH THE CERTIFICATION STANDARDS IS ALWAYS MANDATORY THE USE OF THREADED INSERTS

PER RAGGIUNGERE GLI STANDARD DI CERTIFICAZIONE È SEMPRE OBBLIGATORIO L'UTILIZZO DEGLI INSERTI FILETTATI

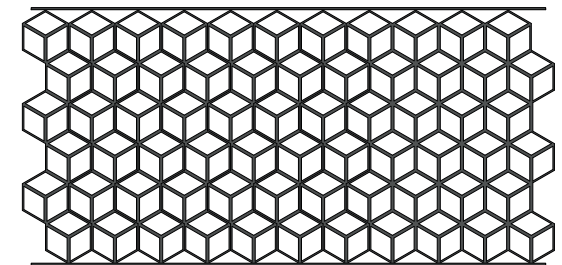

**3**

### The Panel

It is the ornamental part of the system. The numerous models and high-quality finishes make it a timeless design product. The geometric lines skillfully blend with the iron, giving life to an object that dialogues between past and future.

### Il pannello

È la parte ornamentale del sistema. I numerosi modelli e le pregiate finiture lo rendono un prodotto dal design senza tempo. Le linee geometriche si fondono sapientemente con il ferro dando vita a un oggetto che dialoga tra passato e futuro.

## THE SYSTEM | THE STRUCTURE AND THE NEVEL POST IL SISTEMA | LA STRUTTURA E I MONTANTI

The structural core of the system is made up of newel posts with a load-bearing capacity of 1 kN (those for railings are also available in 2kN) and a handrail. Each individual element can be chosen in the flat, round or square version. And they have been designed to provide **maximum safety and aesthetic harmony**.

L'anima strutturale del sistema è formata da montanti con tenuta da 1kN (quelli per i parapetti sono disponibili anche da 2 kN) e un corrimano. Ogni singolo elemento può essere scelto nella versione piatta, tonda o quadrata. E sono stati progettati per fornire la **massima sicurezza e armonia estetica**.

 For the handrail item number see page 63  
Per il codice del corrimano si veda pag. 63

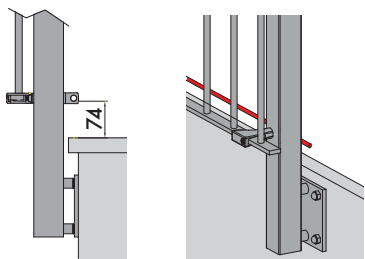

\* SAFETY DETAIL OF LATERAL ANCHORAGE  
DETTAGLIO DI SICUREZZA ANCORAGGIO LATERALE

In order to meet the safety criteria provided by the various and increasingly limiting regulations, in case of lateral anchorage it will be necessary to insert the safety round bar  $\varnothing$  12 mm. The round bar, in fact, installed at the correct distance, canceled or prevents the possibility of falling.

Al fine di soddisfare i criteri di sicurezza previsti dalle diverse e sempre più limitanti normative, in caso di ancoraggio laterale si renderà necessario l'inserimento di un tondino di sicurezza di  $\varnothing$  12 mm. Il tondino, infatti, installato alla corretta distanza, annulla o impedisce la possibilità di caduta.

## RAILING PARAPETTI

Newel post with both 1kN and 2kN strength Montanti  
Montanti con tenuta sia da 1 kN che da 2 kN

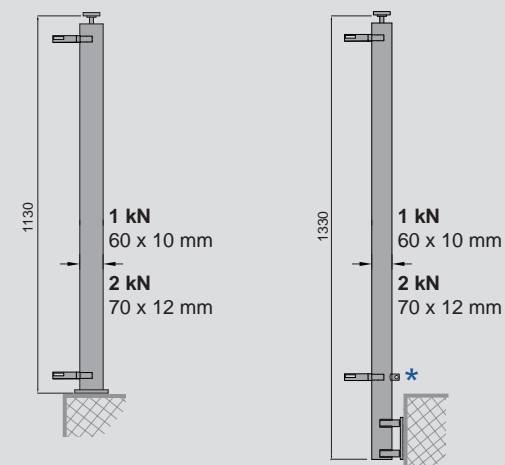

RAILING  
PARAPETTI

FENCING  
RECINZIONI

BALCONY  
BALCONI

Newel post with both 1kN and 2kN strength  
Montanti con tenuta sia da 1 kN che da 2 kN

With 2kN resistance  
for openings smaller than 1300 mm

Con tenuta da 2kN  
per luci inferiori a 1300 mm

SQUARE POST  
MONTANTE QUADRATO

Tube flat handrail  
Corrimano piatto in tubo  
60 x 20 mm



ROUND POST  
MONTANTE TONDO

Tube flat handrail  
Corrimano piatto in tubo  
60 x 20 mm



SQUARE POST FOR  
FENCING SYSTEM  
MONTANTE QUADRATO PER  
VERSIONE FENCING SYSTEM



ANCHORAGE WITH CLAMP  
FOR BALCONY ANCORAGGIO  
SOLO PINZA PER BALCONI

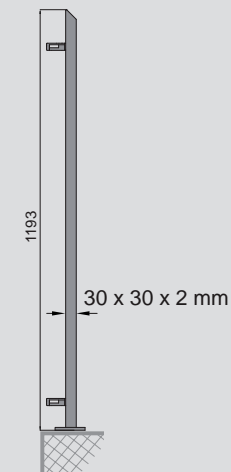
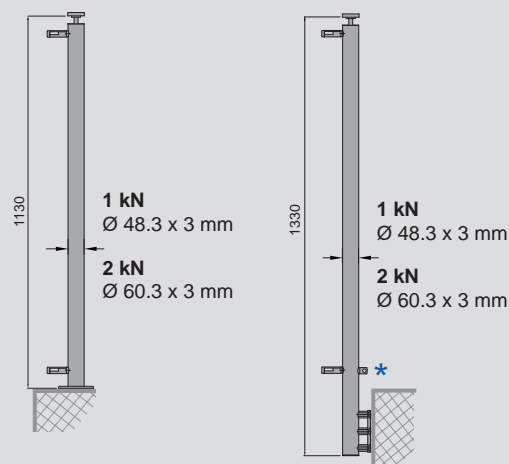
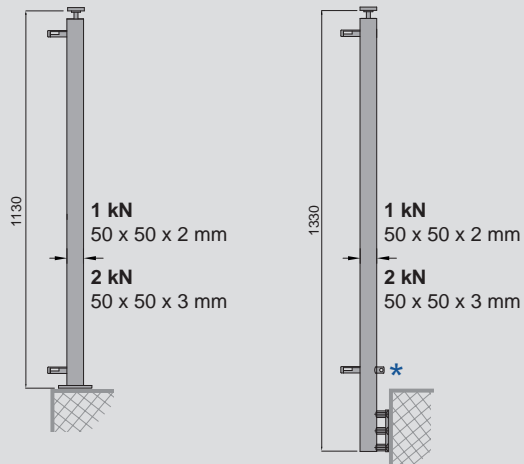

We supply the Arteferro System kit for direct anchoring on wall also with insulating coating. See page 63.

Forniamo il kit di Arteferro System per ancoraggio diretto su muro anche con cappotto isolante. Si veda pagina 63.

## THE SYSTEM | THE CLACK CLAMP IL SISTEMA | LA PINZA CLACK

To install a railing or a balustrade, all you need is a clack! And the professional's job becomes simpler and faster. From the innovation and attention to the needs of professionals that have always characterized Arteferro System solutions, a **new patented joining clamp** is born: a solution that facilitates and speeds up the installation of railings and balustrades.

Per installare un parapetto o una ringhiera da oggi basta un clack! E il lavoro del professionista è più semplice e veloce. Dall'innovazione e attenzione alle esigenze dei professionisti, che da sempre contraddistinguono le soluzioni Arteferro System, nasce una **nuova pinza di giunzione brevettata**: una soluzione che facilita e velocizza l'installazione di parapetti e ringhiere.





The new joining clamp between the infill panel and the supporting structure **does not require screws**, just a **simple press**, and the clamp closes easily, permanently locking the elements to be joined in complete safety. And a special pressure key has been designed to open it in just a few moments. In this way, time is saved, and the work can be carried out autonomously, without the help of others.

La nuova pinza di giunzione tra il pannello di tamponamento e la struttura portante **non necessita infatti di viti**, basta **una semplice pressione** e la pinza si chiude con estrema facilità bloccando definitivamente e in totale sicurezza gli elementi da unire. E per riaprirlo è stata studiata una speciale chiave a pressione che in pochi istanti sblocca la pinza. In questo modo si risparmia tempo e il lavoro può essere svolto in totale autonomia, senza l'aiuto di altre persone.

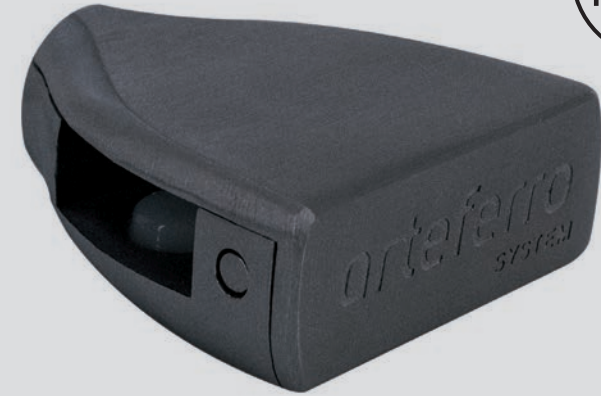

NO installation accessories  
NO accessori di montaggio



NO screw  
NO viti

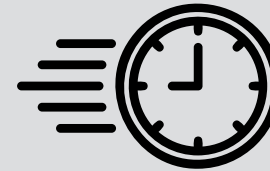

Facile e Veloce da installare.  
Basta una semplice pressione

Facile e Veloce da installare.  
Basta una semplice pressione

ACCESSORY  
ACCESSORIO



Practical pressure key to release the clamp. With ergonomic handle for use even in the most demanding construction sites."

Pratica chiave a pressione per sganciare la pinza. Con impugnatura ergonomica per l'utilizzo anche nei cantieri più impegnativi.



## THE SYSTEM | THE PANELS IL SISTEMA | I PANNELLI

Classic or modern, designed to **elegantly fit into any architectural context**. The numerous models, to be combined with the types of uprights and handrails, allow you to create a unique and coordinated solution for parapets, balconies, and fences.”

Classici o moderni, progettati per **inserirsi elegantemente in qualsiasi contesto** architettonico. I numerosi modelli, da abbinare alle tipologie di montante e corrimano, consentono di realizzare una soluzione unica e coordinata per parapetti, balconi e recinzioni.





# SIRMIONE



To download the 3D-block file:  
Per scaricare il blocco 3D:

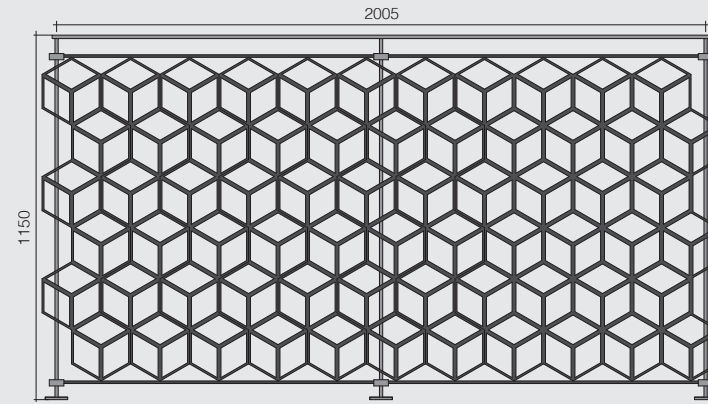
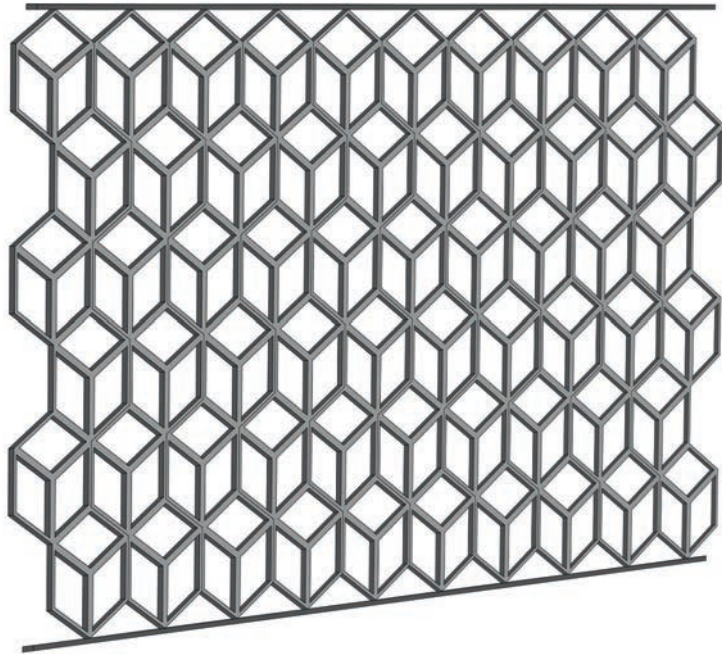

railing applications  
applicazione per parapetti

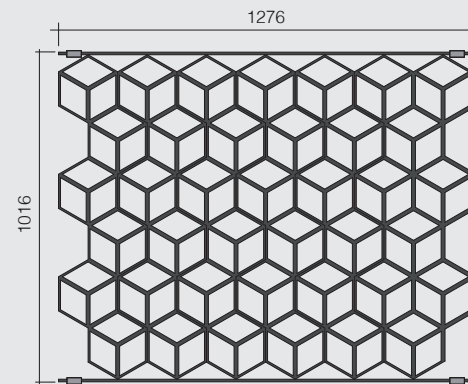

balcony applications  
applicazione per balconi

USE - UTILIZZO

ANCHORING - ANCORAGGIO



arterferro





# FIRENZE



To download the 3D-block file:  
Per scaricare il blocco 3D:

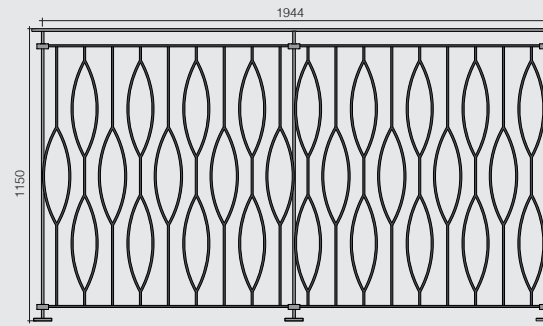
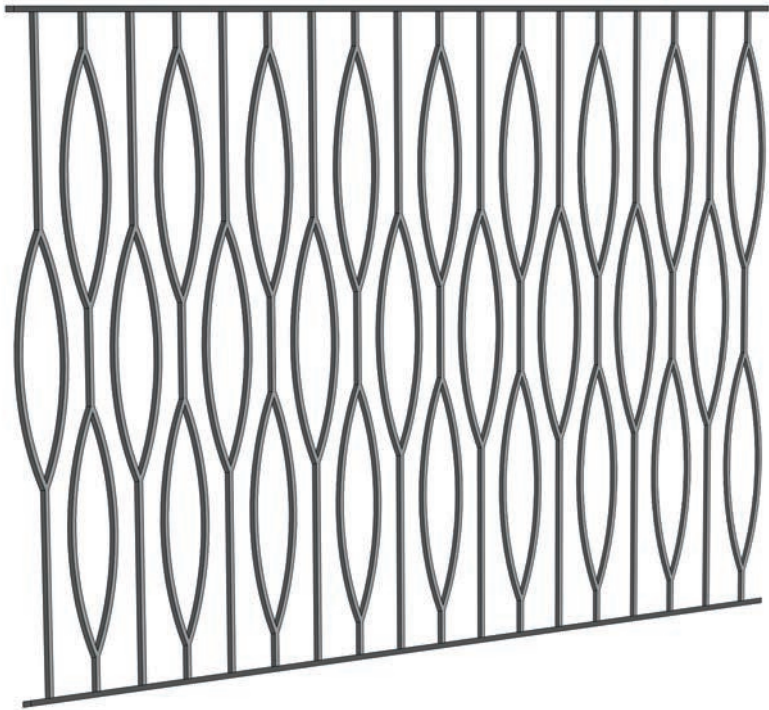

railing applications  
applicazione per parapetti

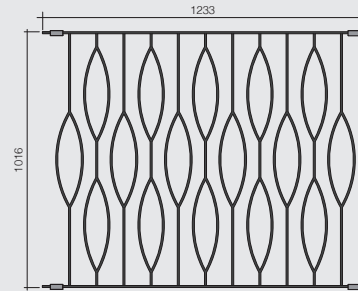

balcony applications  
applicazione per balconi

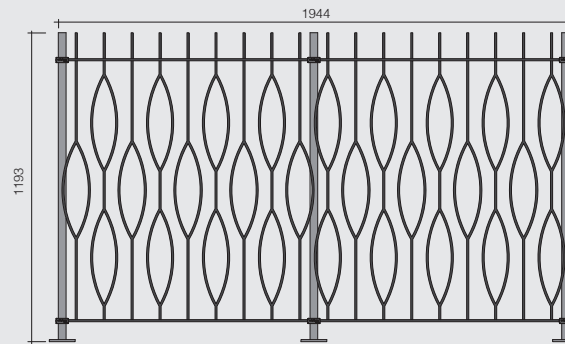

fencing applications  
applicazione per recinzioni

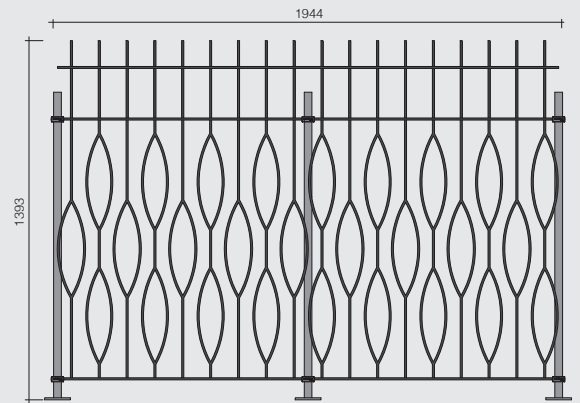

USE - UTILIZZO

ANCHORING - ANCORAGGIO





# TRIESTE



To download the 3D-block file:  
Per scaricare il blocco 3D:

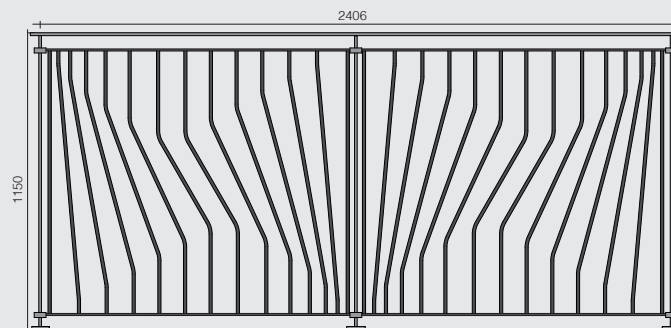
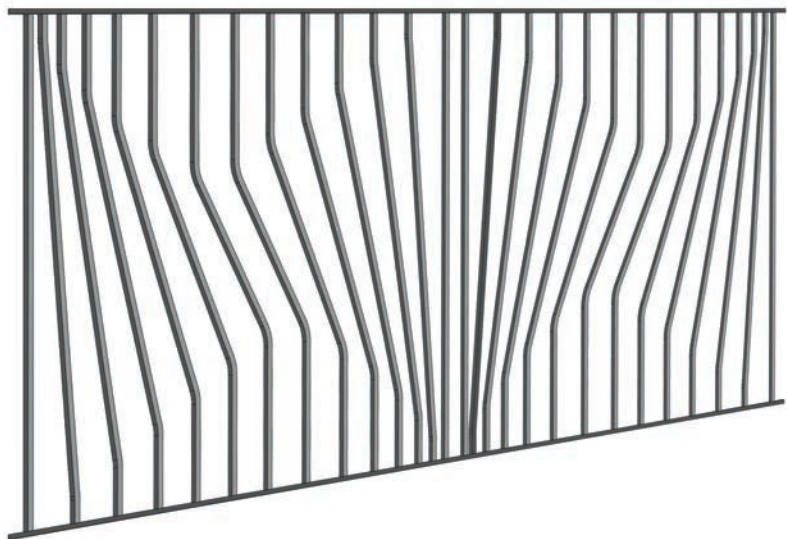

railing applications  
applicazione per parapetti

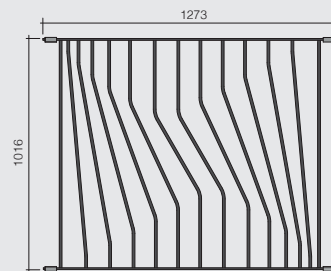

balcony applications  
applicazione per balconi

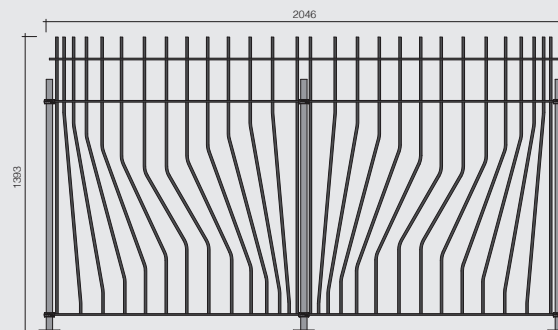
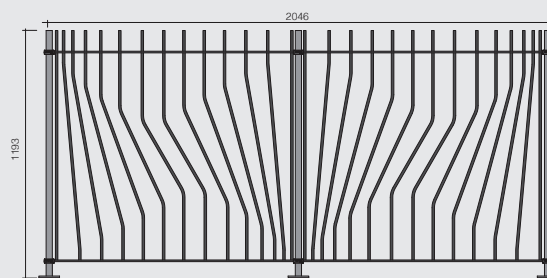

fencing applications  
applicazione per recinzioni

USE - UTILIZZO

ANCHORING - ANCORAGGIO





public library



# ROMA



To download the 3D-block file:  
Per scaricare il blocco 3D:

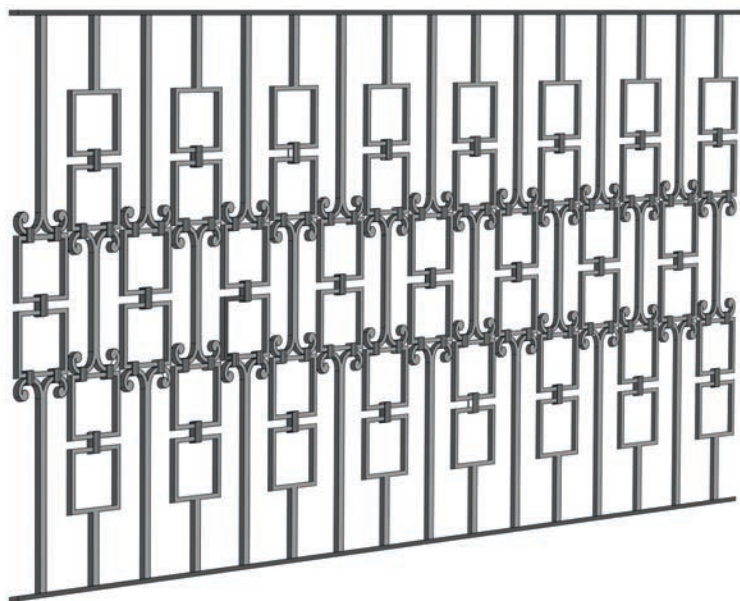

USE - UTILIZZO

ANCHORING - ANCORAGGIO



arteferro

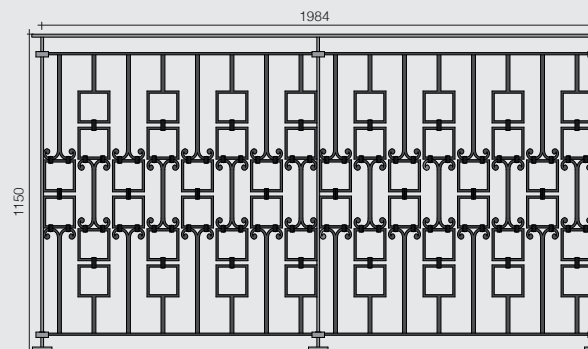

railing applications  
applicazione per parapetti

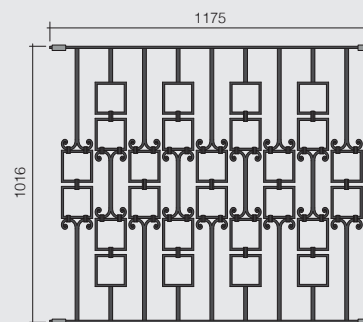

balcony applications  
applicazione per balconi

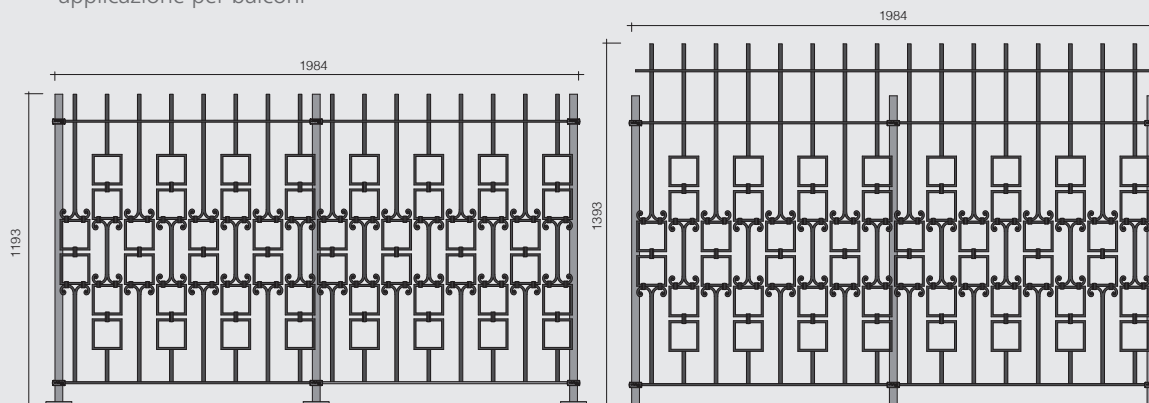

fencing applications  
applicazione per recinzioni



# BOLZANO



To download the 3D-block file:  
Per scaricare il blocco 3D:

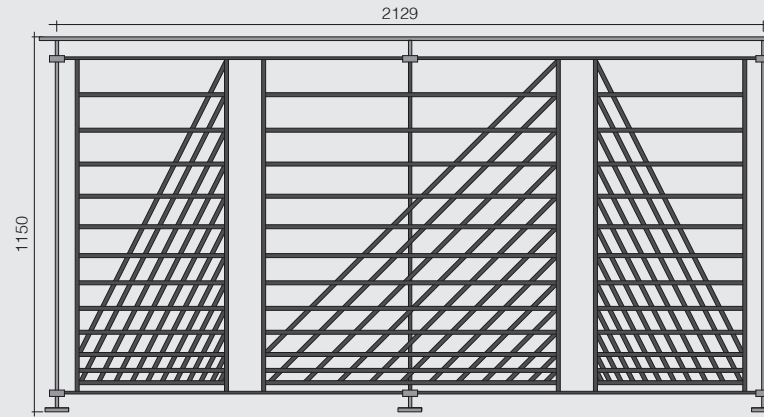
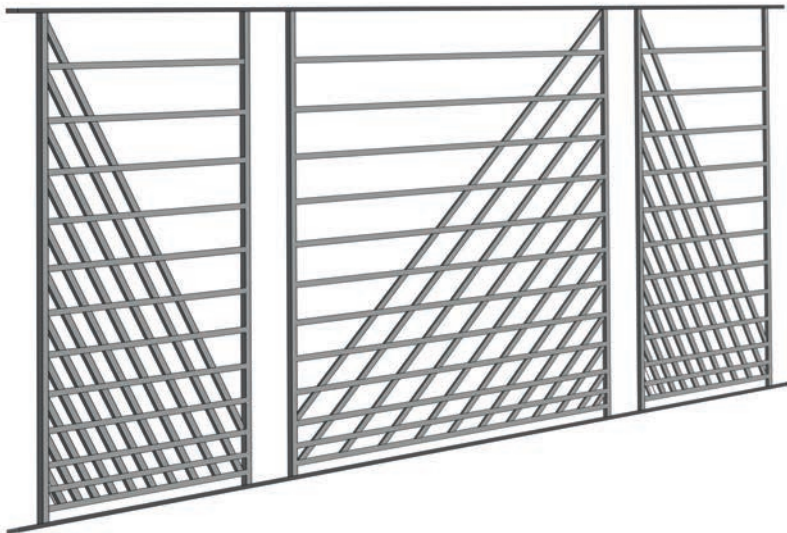

railing applications  
applicazione per parapetti

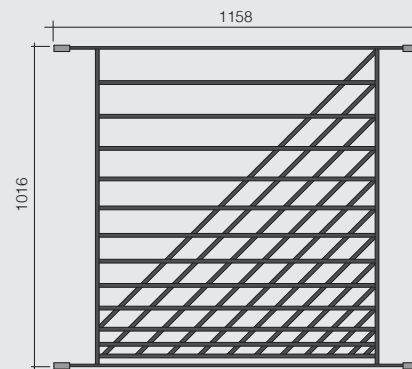

balcony applications  
applicazione per balconi

USE - UTILIZZO

ANCHORING - ANCORAGGIO



**arteferro**





# ORTIGIA



To download the 3D-block file:  
Per scaricare il blocco 3D:

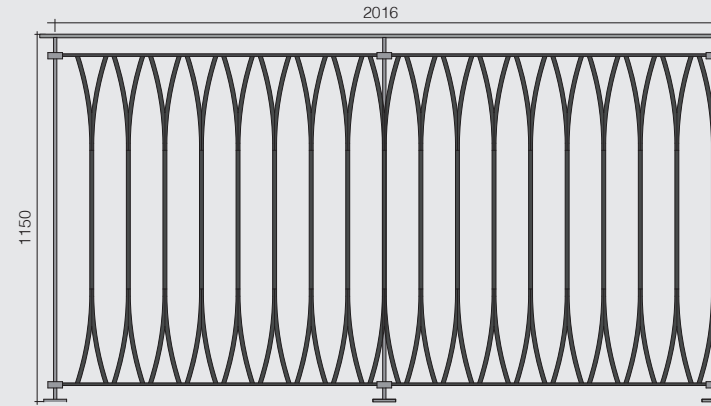
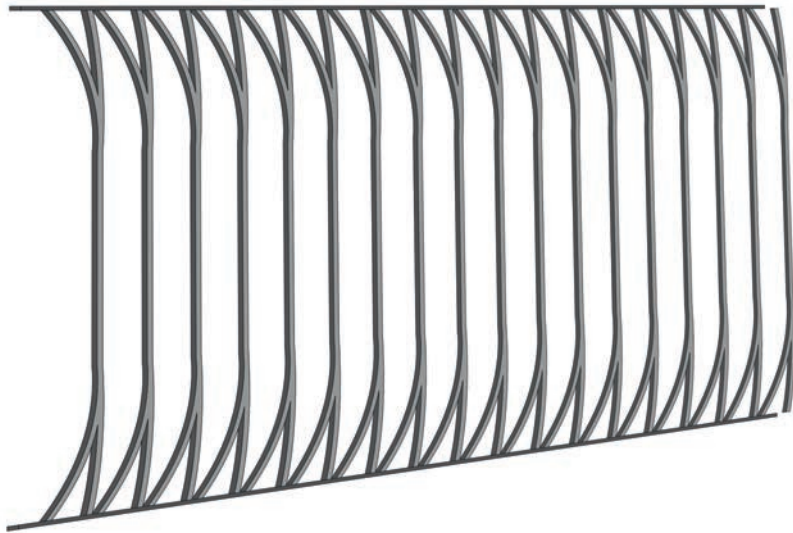

railing applications  
applicazione per parapetti

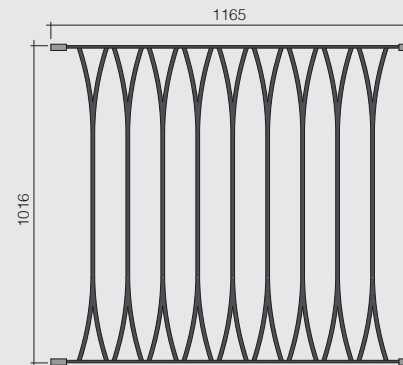

balcony applications  
applicazione per balconi

USE - UTILIZZO

ANCHORING - ANCORAGGIO



**arteferro**

The following image is purely indicative and does not represent the system  
L'immagine seguente è puramente indicativa e non rappresenta il sistema



# PORTOFINO



To download the 3D-block file:  
Per scaricare il blocco 3D:

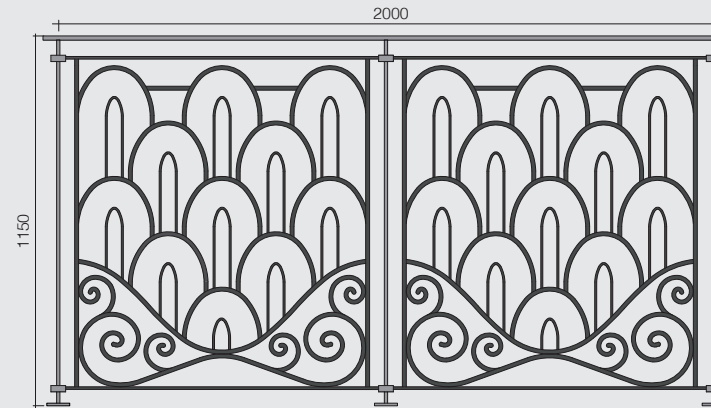
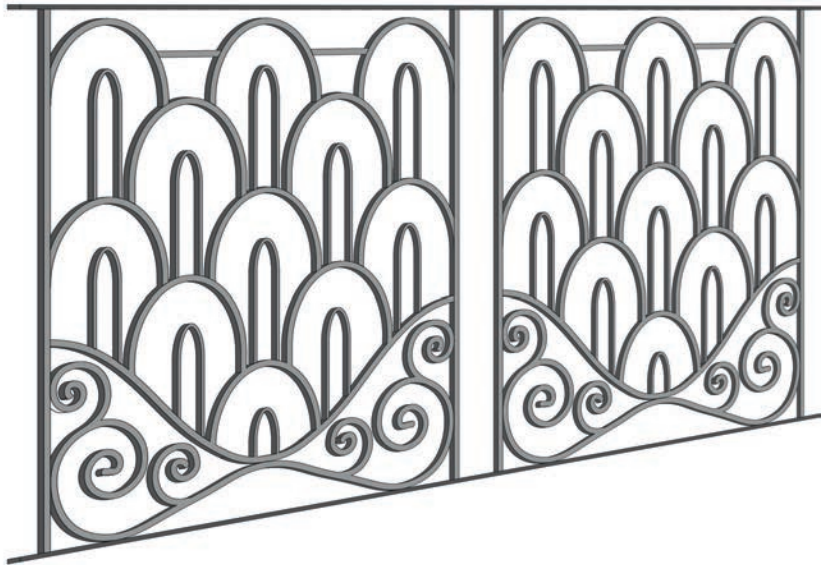

railing applications  
applicazione per parapetti

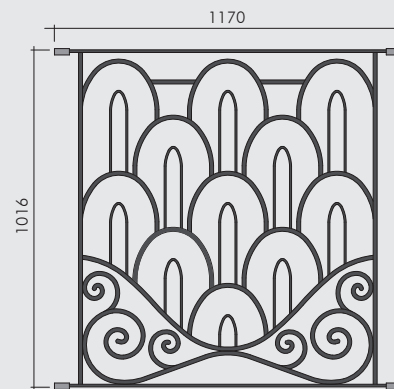

balcony applications  
applicazione per balconi

USE - UTILIZZO

ANCHORING - ANCORAGGIO





BOLOGNA



To download the 3D-block file:  
Per scaricare il blocco 3D:

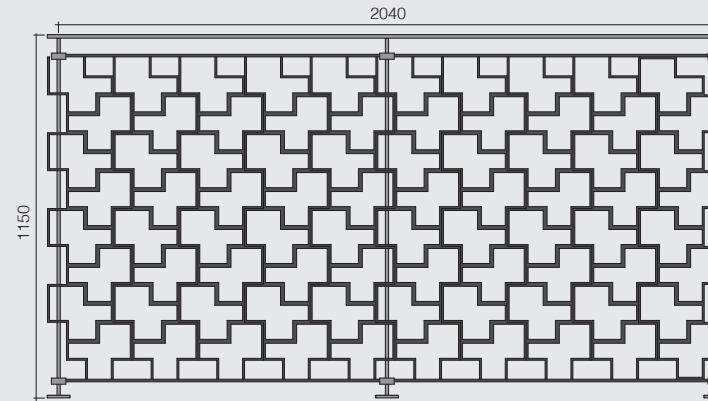
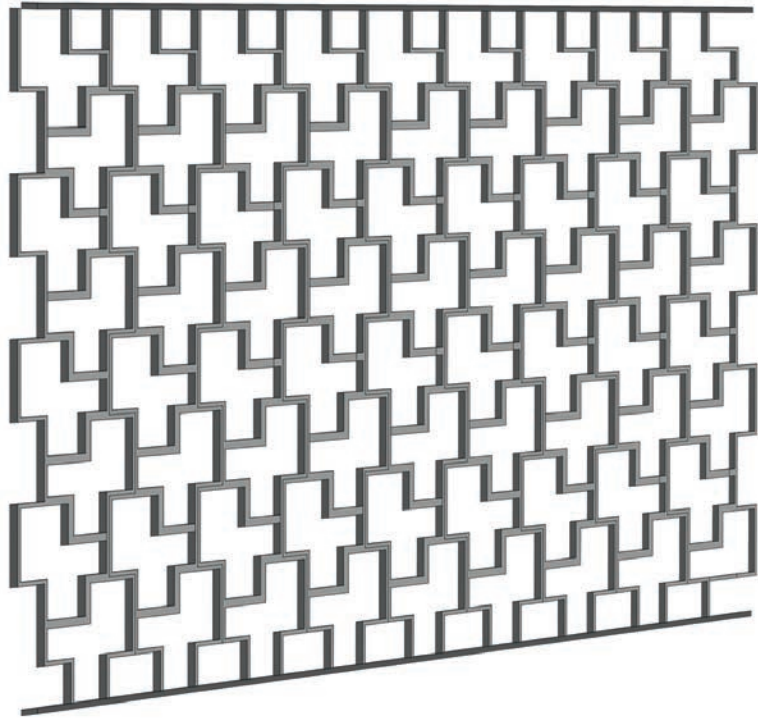

railing applications  
applicazione per parapetti

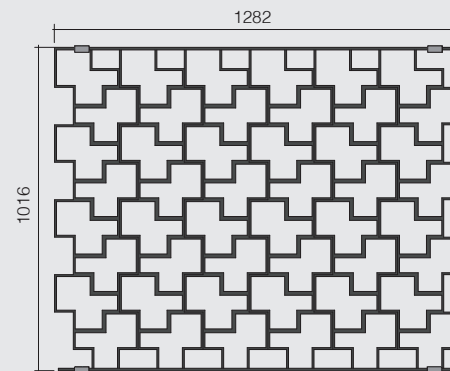

balcony applications  
applicazione per balconi

USE - UTILIZZO

ANCHORING - ANCORAGGIO



arteferro



# STRESA



To download the 3D-block file:  
Per scaricare il blocco 3D:

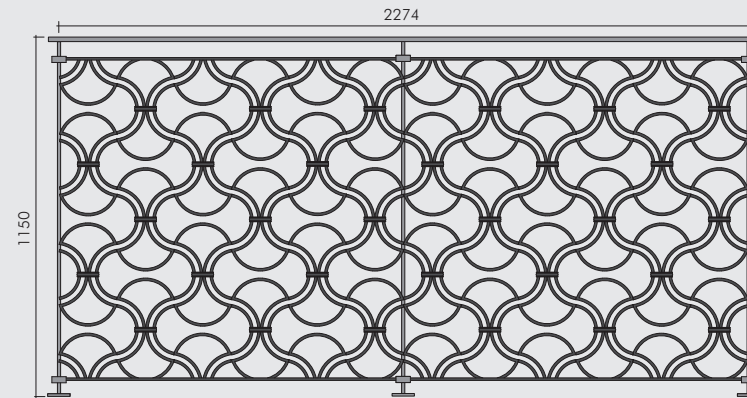
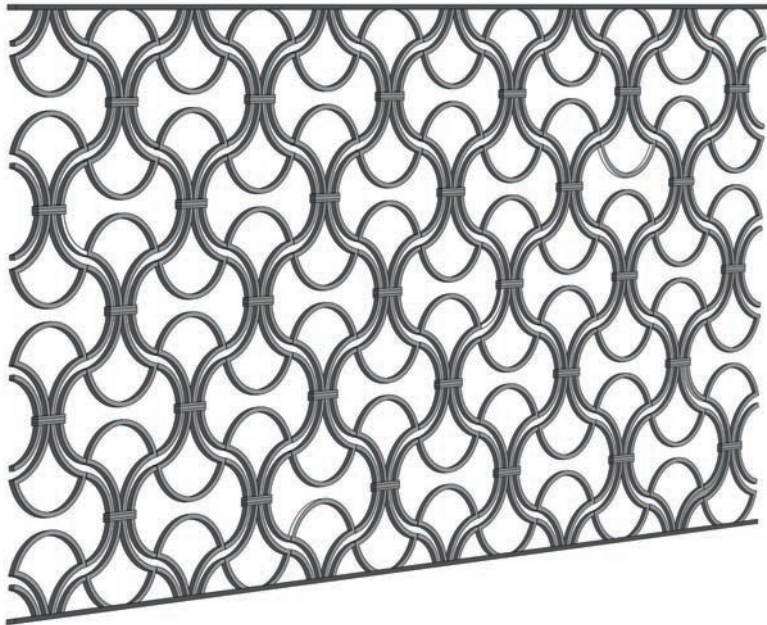

railing applications  
applicazione per parapetti

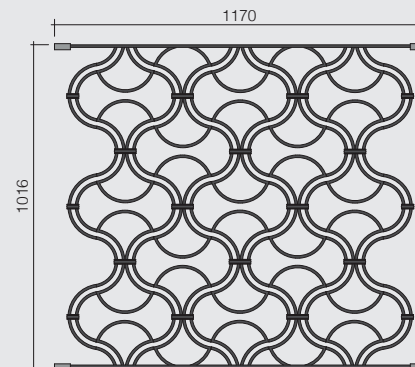

balcony applications  
applicazione per balconi

USE - UTILIZZO

ANCHORING - ANCORAGGIO



arteferro





# NAPOLI



To download the 3D-block file:  
Per scaricare il blocco 3D:

A

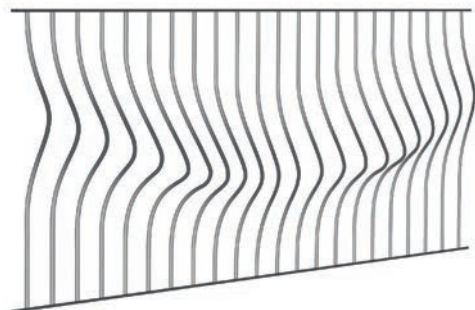

B

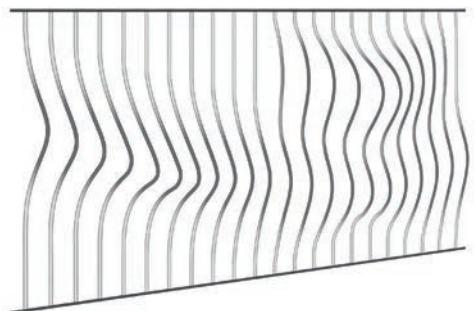

C

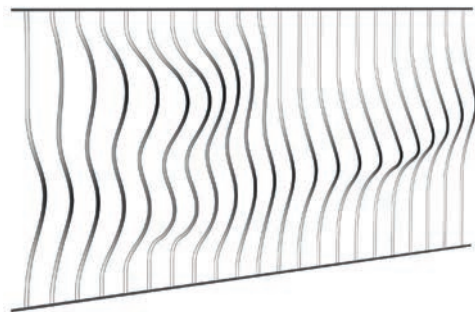

USE - UTILIZZO

ANCHORING - ANCORAGGIO



arteferro

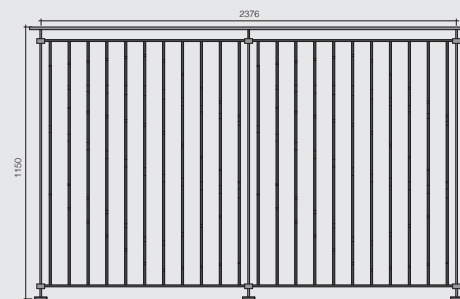

railing applications  
applicazione per parapetti

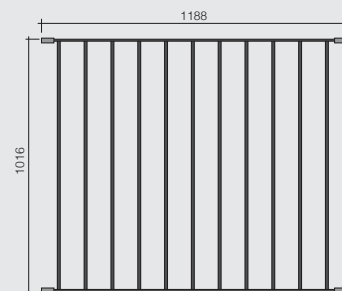

balcony applications  
applicazione per balconi

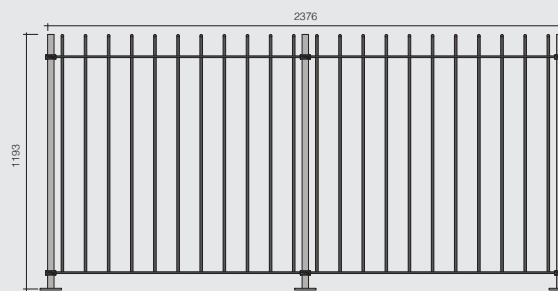
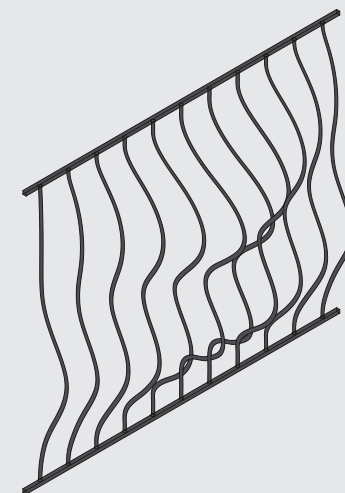

fencing applications  
applicazione per recinzioni

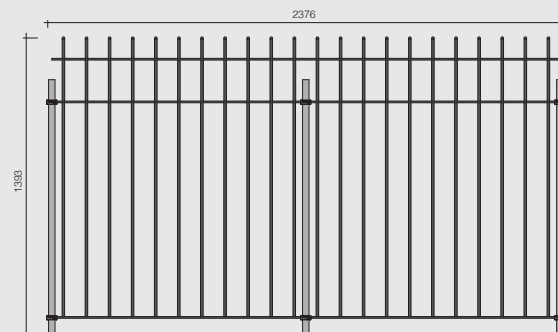



# VENEZIA



To download the 3D-block file:  
Per scaricare il blocco 3D:

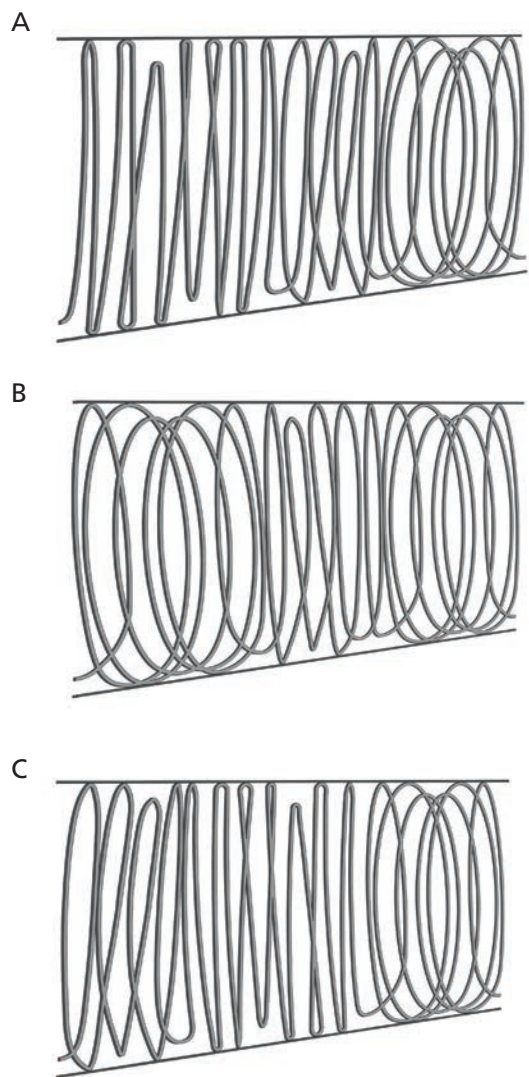

USE - UTILIZZO

ANCHORING - ANCORAGGIO

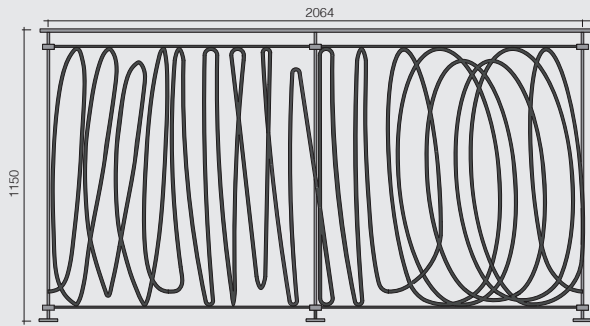
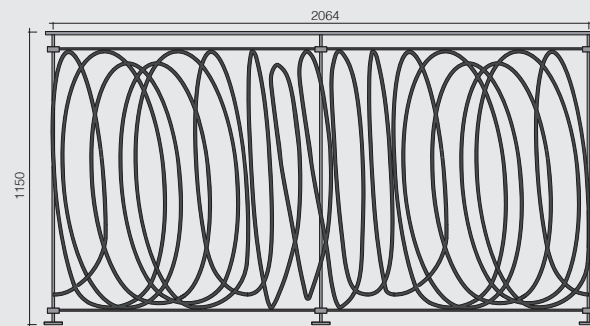
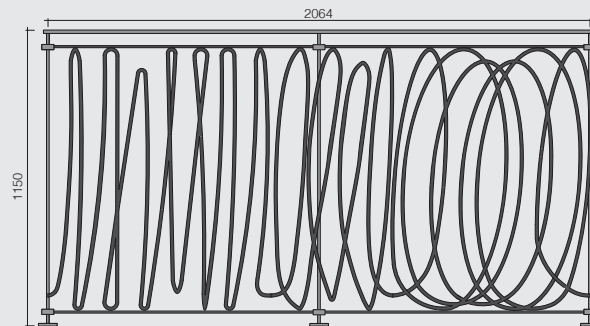

railing applications  
applicazione per parapetti

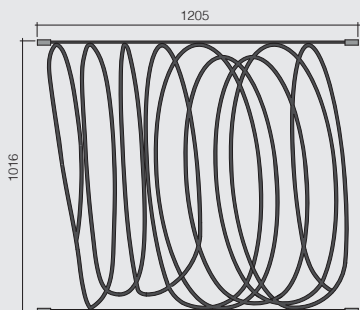
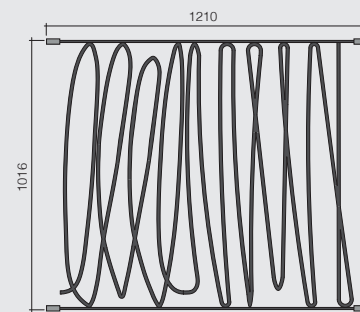

balcony applications  
applicazione per balconi



# PERUGIA



To download the 3D-block file:  
Per scaricare il blocco 3D:

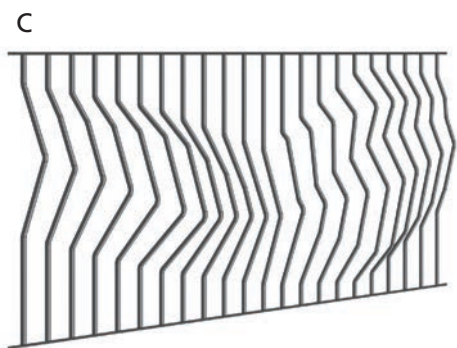
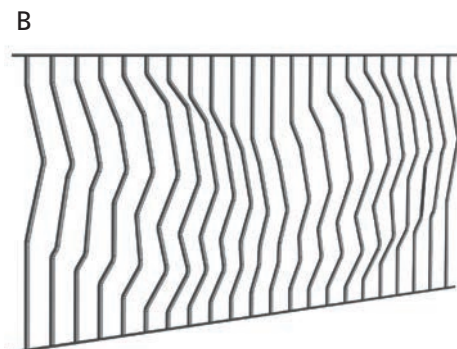
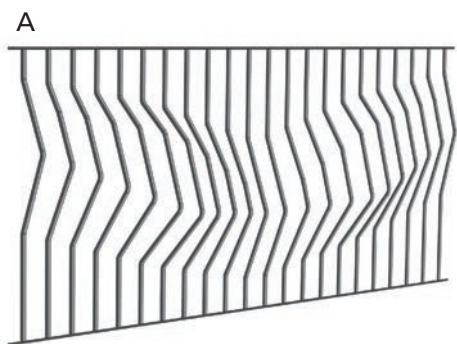

USE - UTILIZZO

ANCHORING - ANCORAGGIO



arteferro

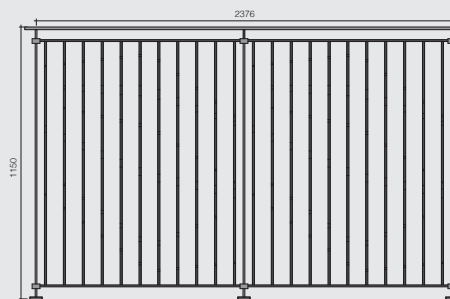

railing applications  
applicazione per parapetti

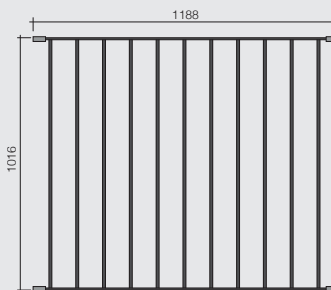

balcony applications  
applicazione per balconi

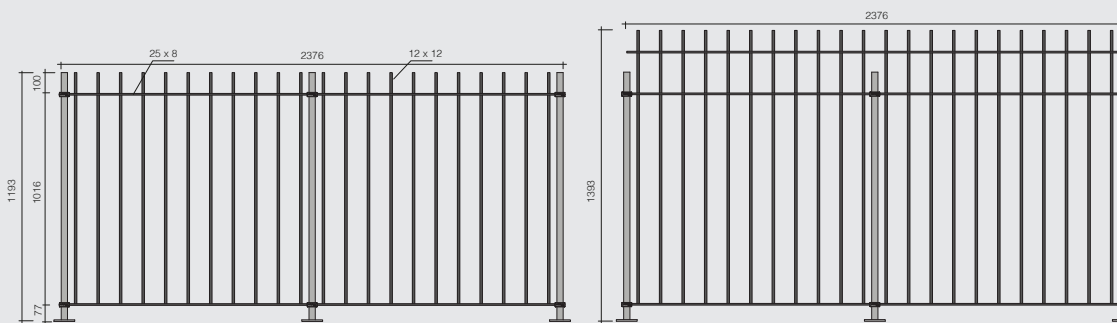
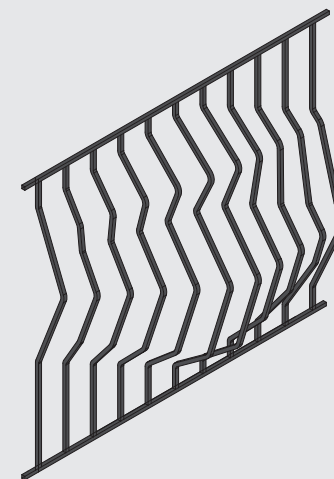

fencing applications  
applicazione per recinzioni



# ASCOLI



To download the 3D-block file:  
Per scaricare il blocco 3D:

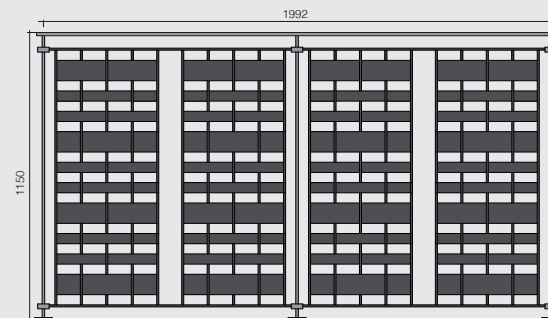
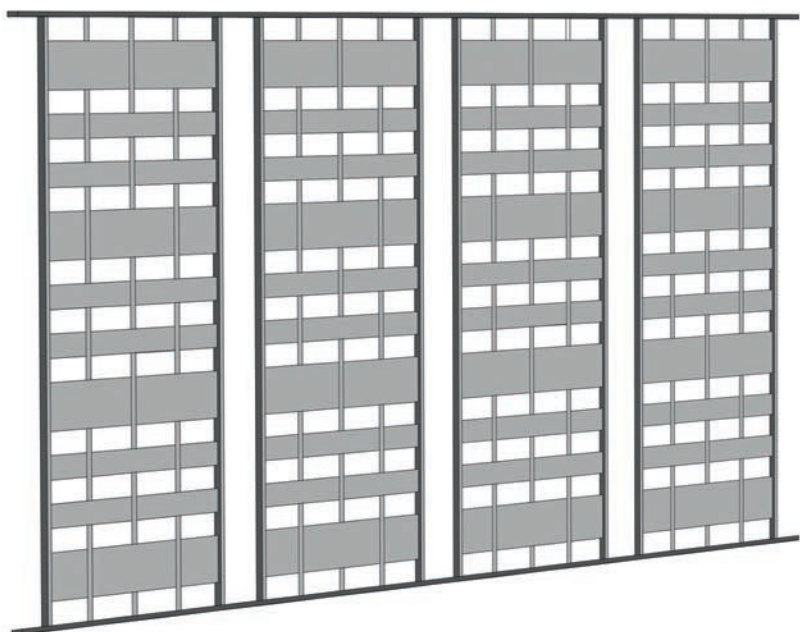

railing applications  
applicazione per parapetti

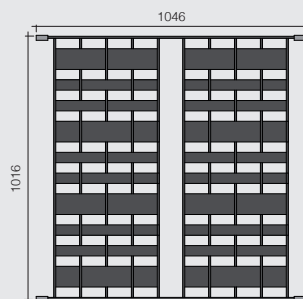

balcony applications  
applicazione per balconi

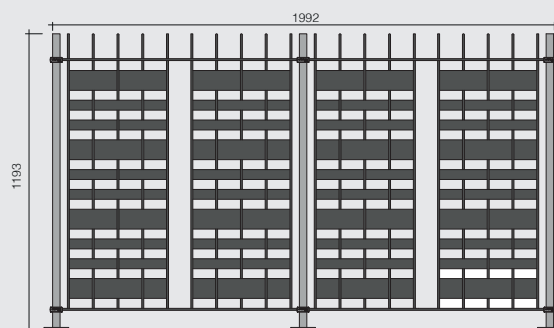

fencing applications  
applicazione per recinzioni

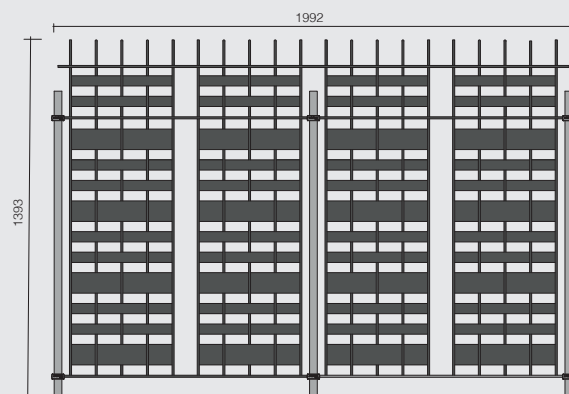

USE - UTILIZZO

ANCHORING - ANCORAGGIO



arteferro





# TRANI



To download the 3D-block file:  
Per scaricare il blocco 3D:

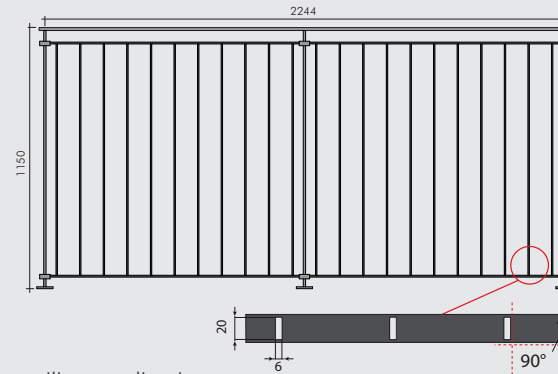
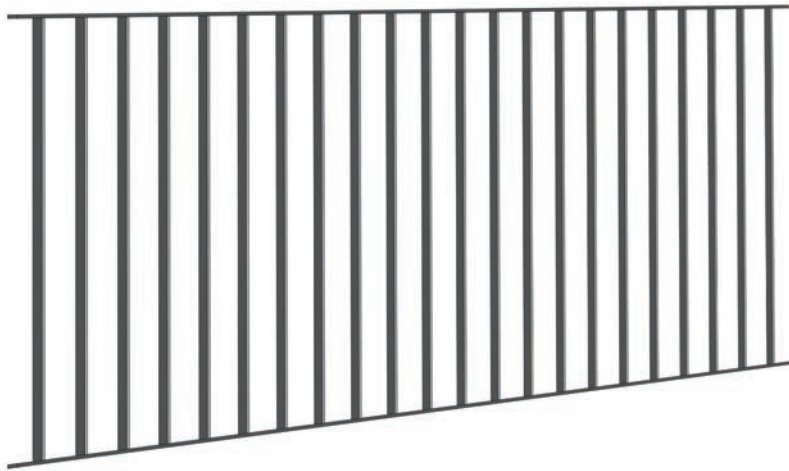

railing applications  
applicazione per parapetti

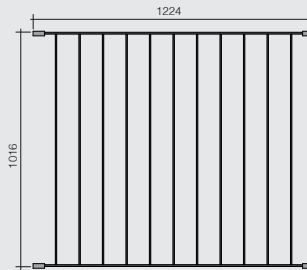

balcony applications  
applicazione per balconi

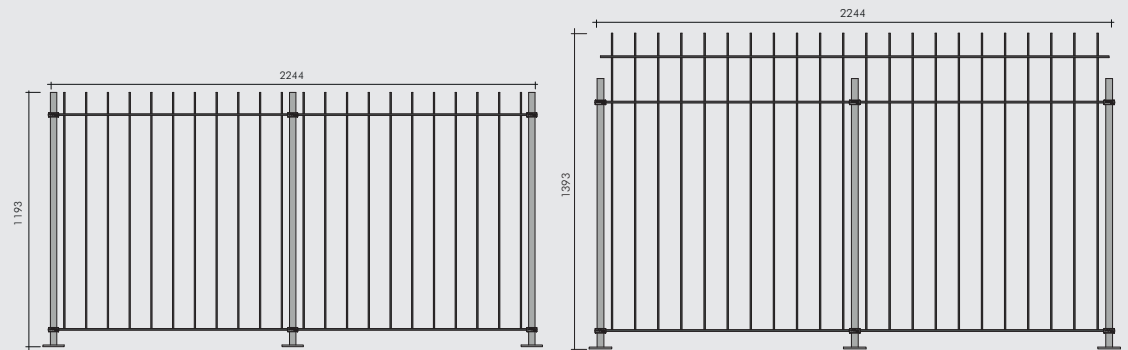

fencing applications  
applicazione per recinzioni

USE - UTILIZZO

ANCHORING - ANCORAGGIO



arteferro



# CAGLIARI



To download the 3D-block file:  
Per scaricare il blocco 3D:

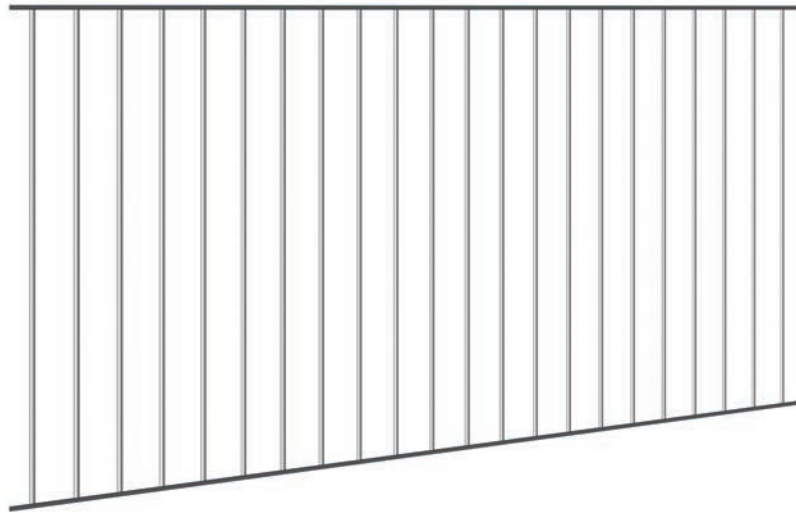

USE - UTILIZZO

ANCHORING - ANCORAGGIO



**arteferro**

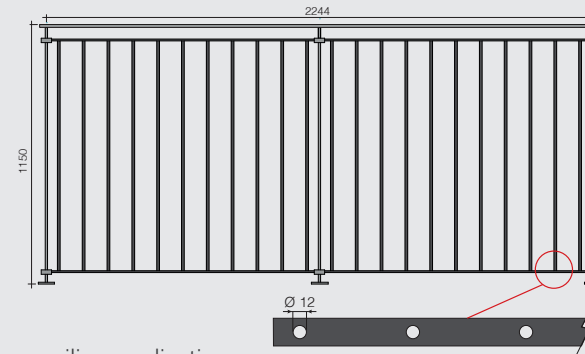

railing applications  
applicazione per parapetti

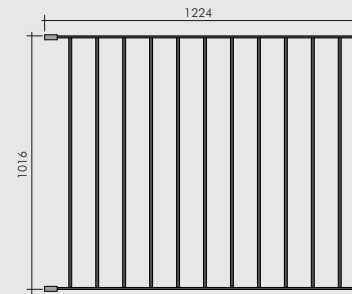

balcony applications  
applicazione per balconi

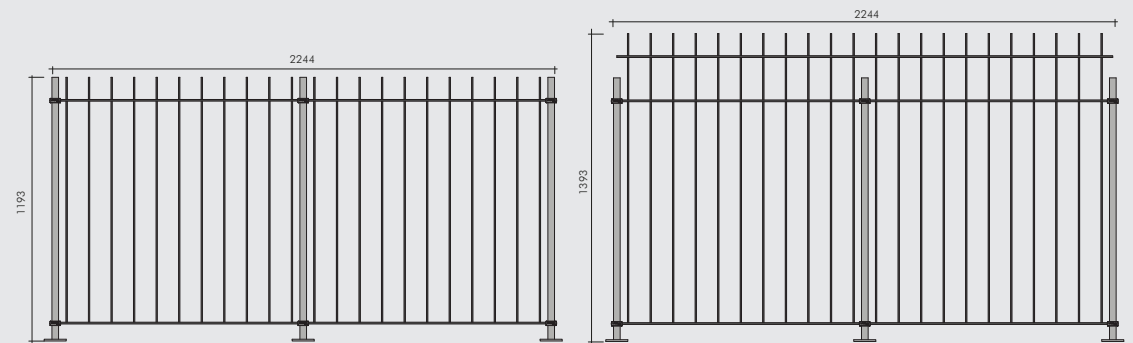

fencing applications  
applicazione per recinzioni



# AOSTA



To download the 3D-block file:  
Per scaricare il blocco 3D:

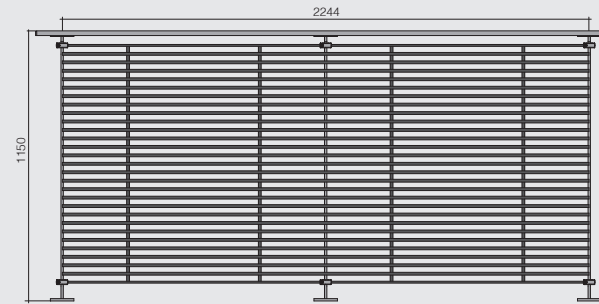
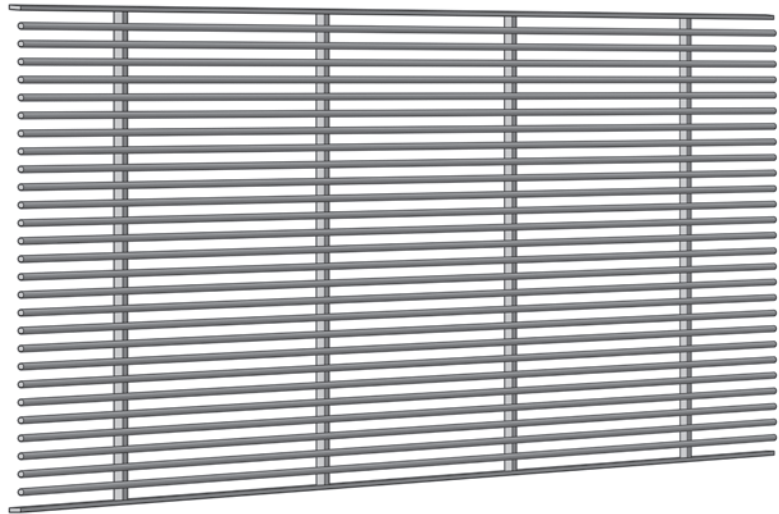

railing applications  
applicazione per parapetti

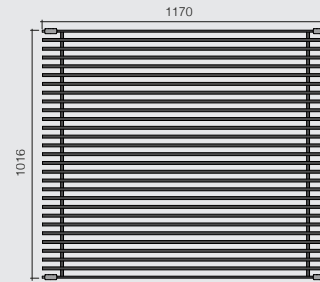

balcony applications  
applicazione per balconi

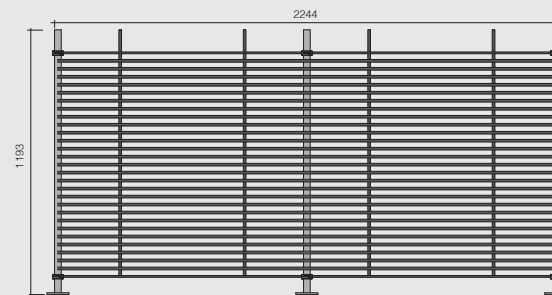

fencing applications  
applicazione per recinzioni

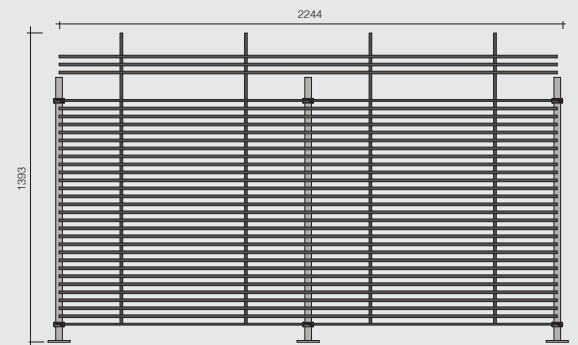

USE - UTILIZZO

ANCHORING - ANCORAGGIO



arteferro



# JESOLO



To download the 3D-block file:  
Per scaricare il blocco 3D:

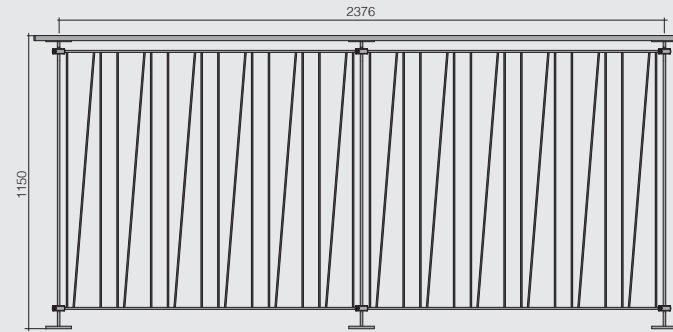
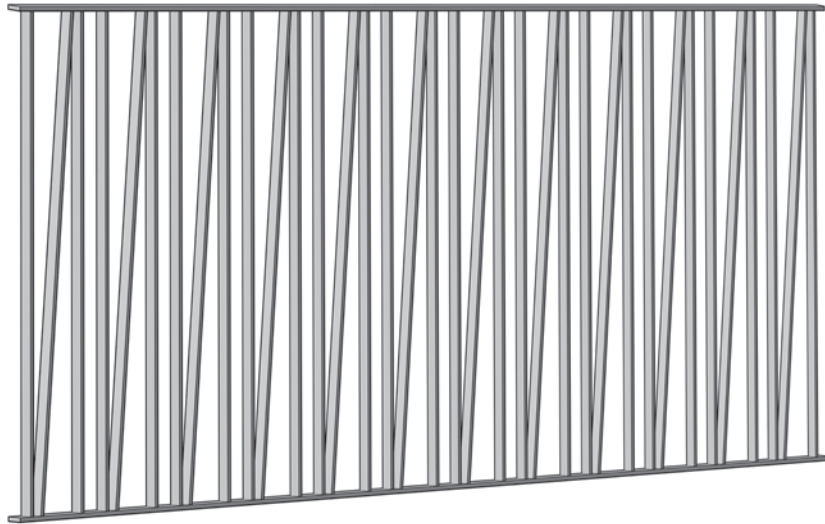

railing applications  
applicazione per parapetti

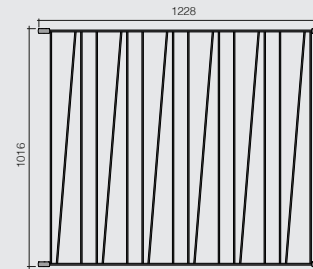

balcony applications  
applicazione per balconi

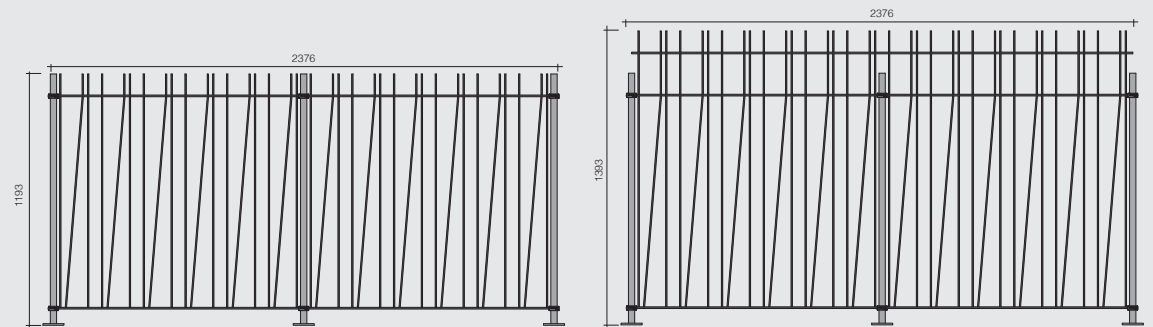

fencing applications  
applicazione per recinzioni

USE - UTILIZZO

ANCHORING - ANCORAGGIO

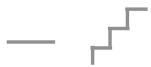





ISEO



To download the 3D-block file:  
Per scaricare il blocco 3D:

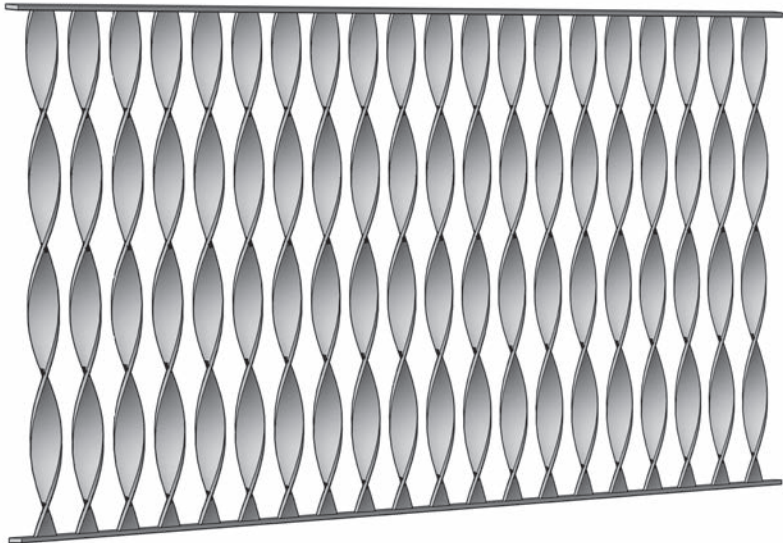

USE - UTILIZZO

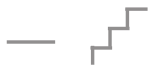

ANCHORING - ANCORAGGIO



arteferro

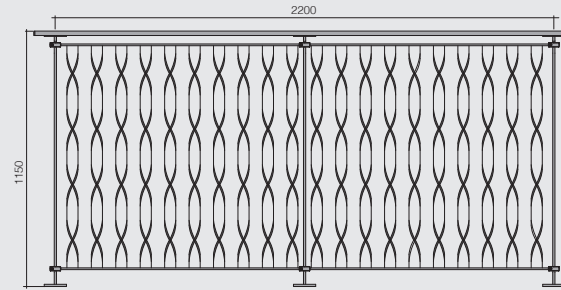

railing applications  
applicazione per parapetti

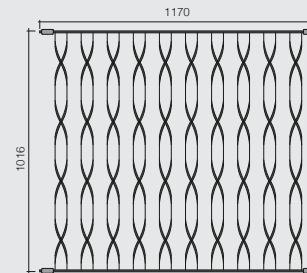

balcony applications  
applicazione per balconi

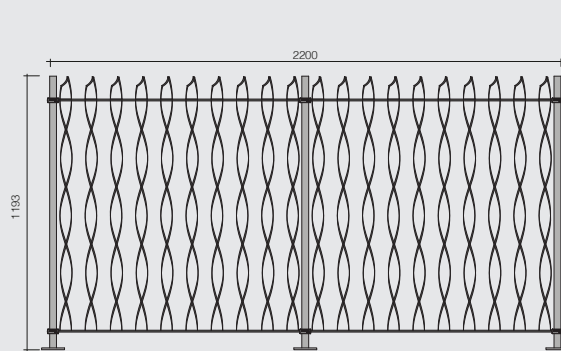

fencing applications  
applicazione per recinzioni

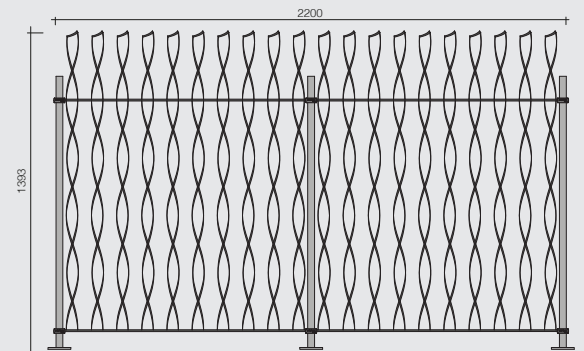



# TORINO



To download the 3D-block file:  
Per scaricare il blocco 3D:

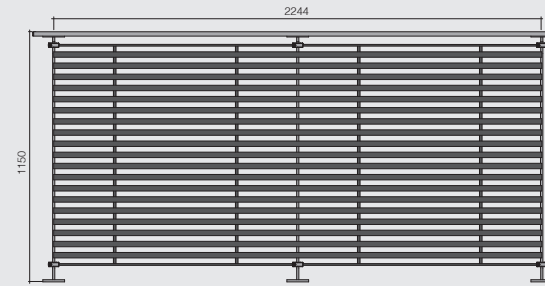

railing applications  
applicazione per parapetti



balcony applications  
applicazione per balconi

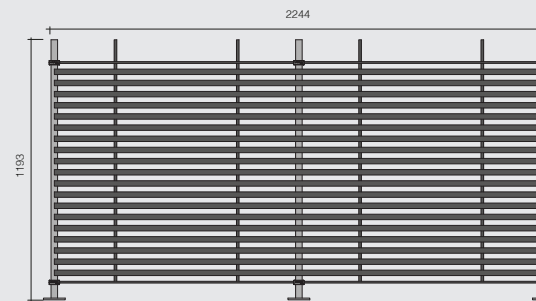

fencing applications  
applicazione per recinzioni

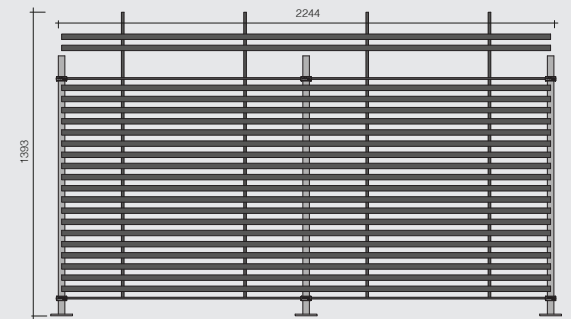

USE - UTILIZZO

ANCHORING - ANCORAGGIO

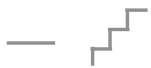



# VICENZA



To download the 3D-block file:  
Per scaricare il blocco 3D:

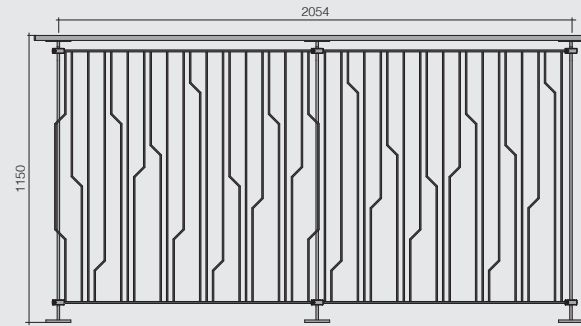
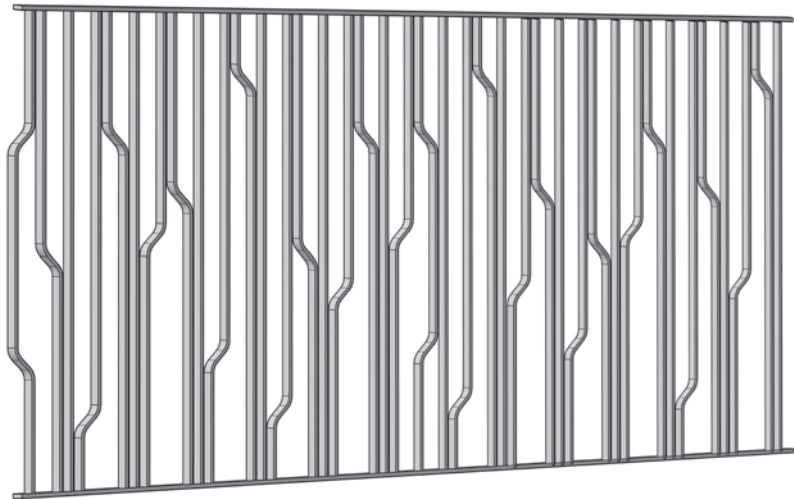

railing applications  
applicazione per parapetti

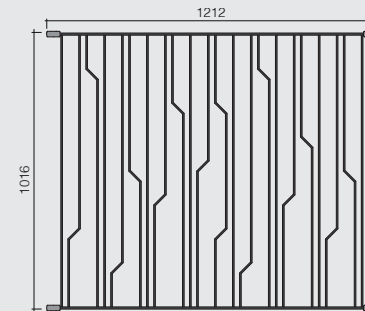

balcony applications  
applicazione per balconi

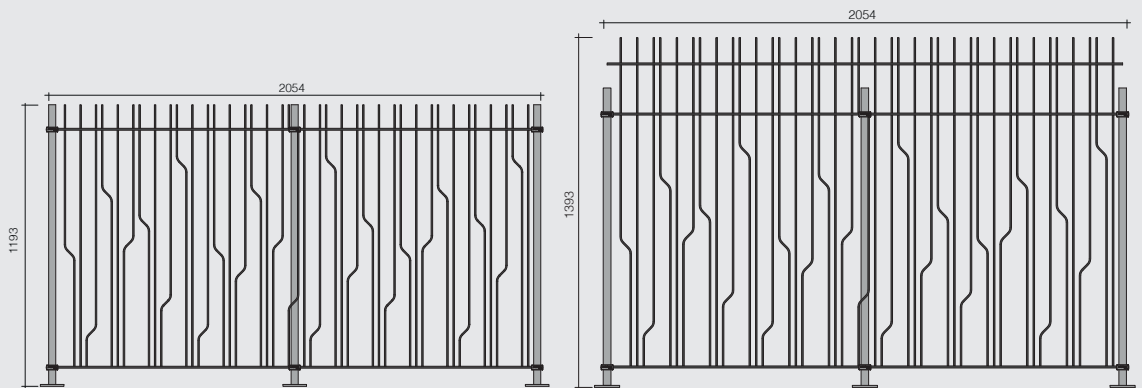

fencing applications  
applicazione per recinzioni

USE - UTILIZZO

ANCHORING - ANCORAGGIO



arteferro



# CORTINA



To download the 3D-block file:  
Per scaricare il blocco 3D:

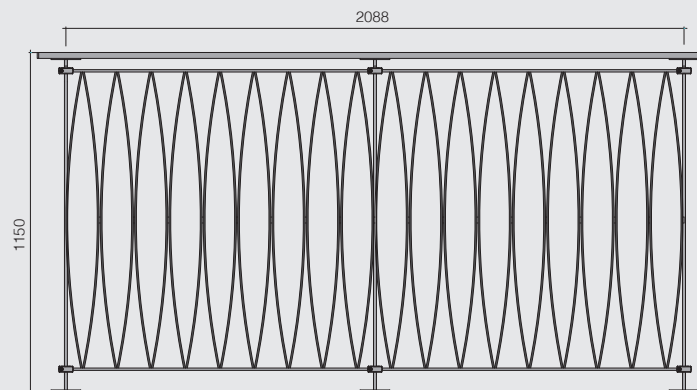
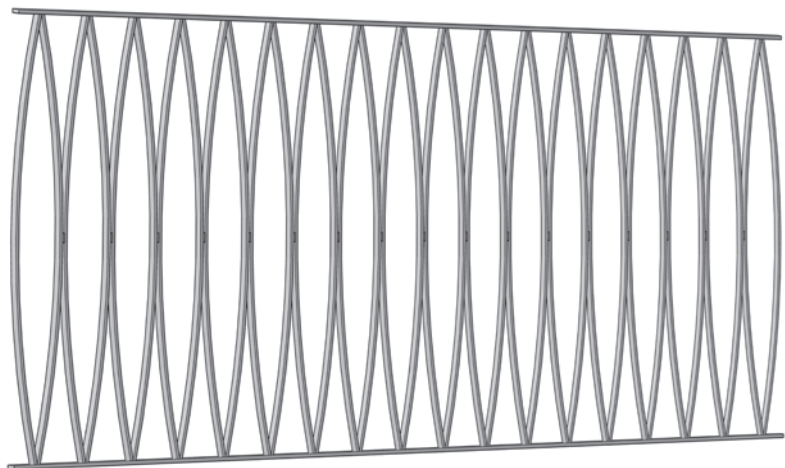

railing applications  
applicazione per parapetti

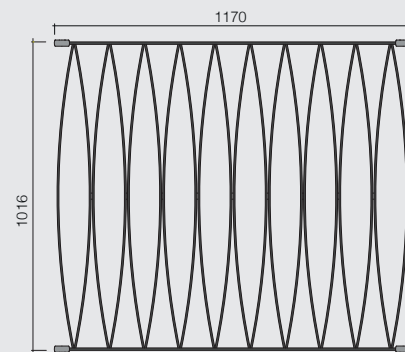

balcony applications  
applicazione per balconi

USE - UTILIZZO

ANCHORING - ANCORAGGIO



**arteferro**





# MILANO



To download the 3D-block file:  
Per scaricare il blocco 3D:

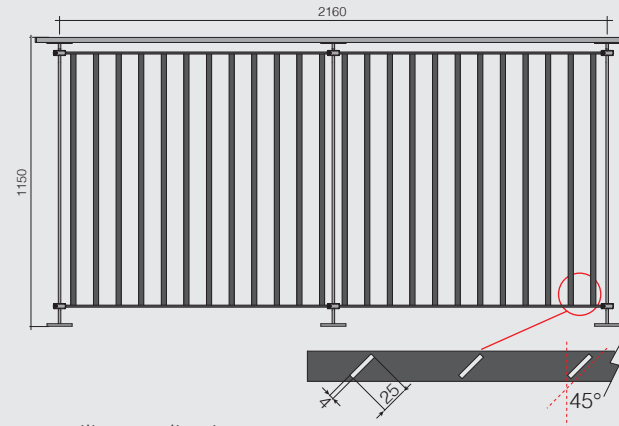
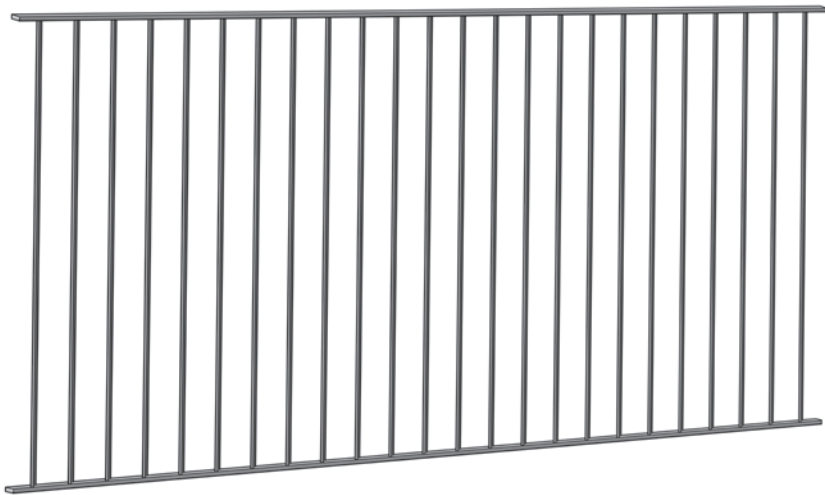

railing applications  
applicazione per parapetti

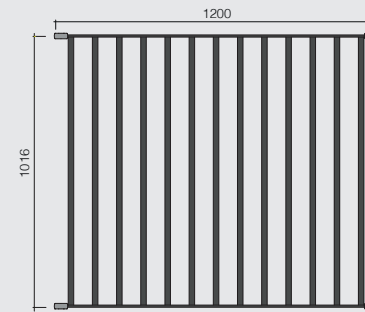

balcony applications  
applicazione per balconi

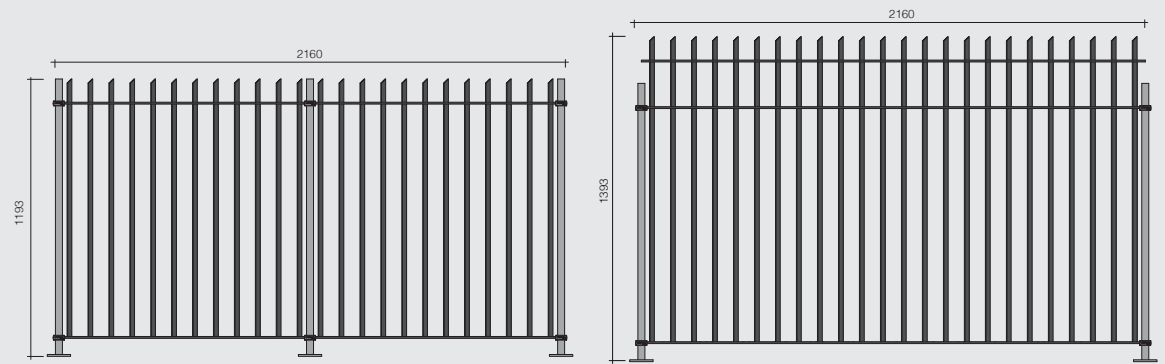

fencing applications  
applicazione per recinzioni

USE - UTILIZZO

ANCHORING - ANCORAGGIO

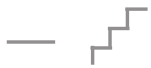

arteferro



# TAORMINA



To download the 3D-block file:  
Per scaricare il blocco 3D:

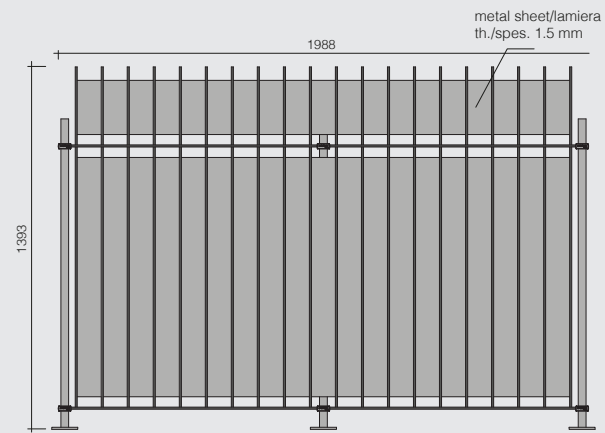
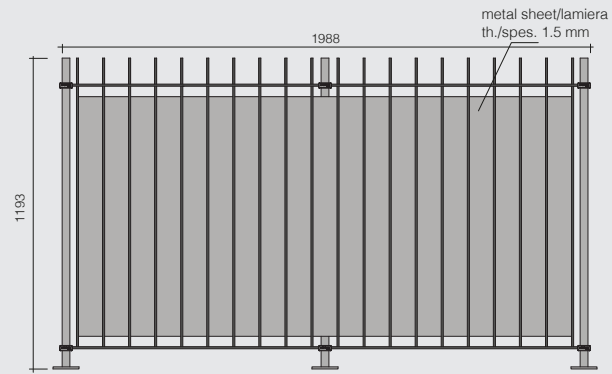
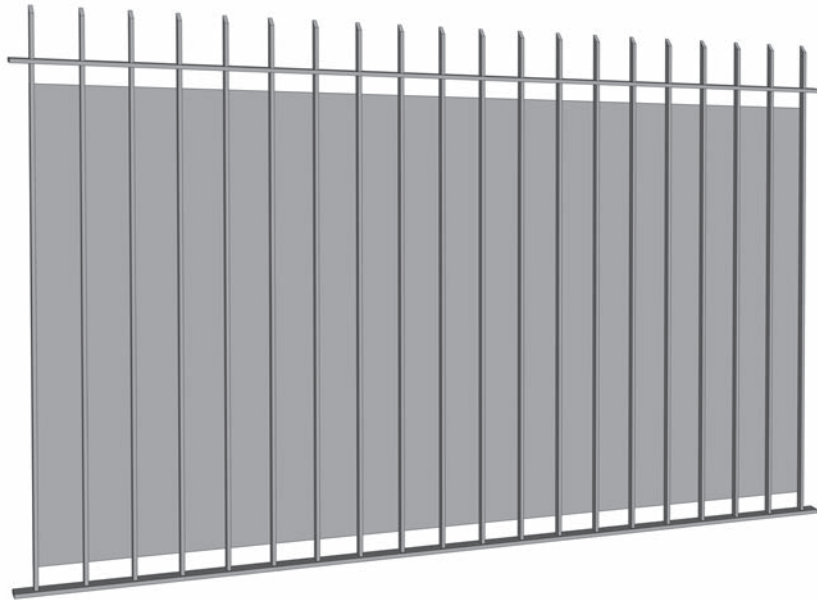

fencing applications  
applicazione per recinzioni

USE - UTILIZZO

ANCHORING - ANCORAGGIO



arteferro



# TROPEA



To download the 3D-block file:  
Per scaricare il blocco 3D:

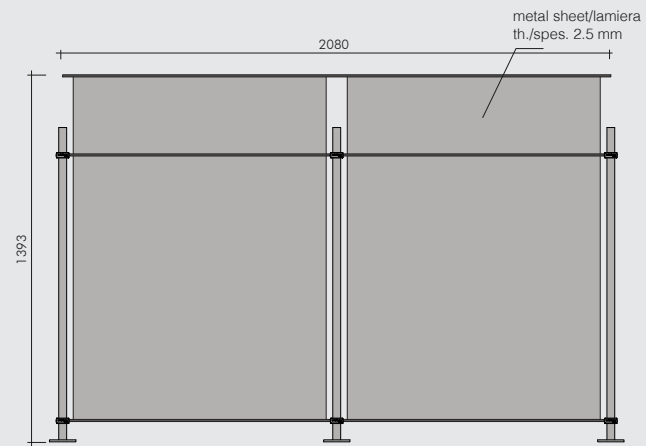
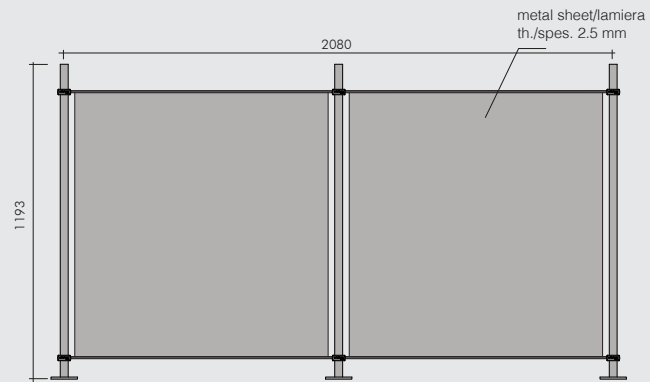
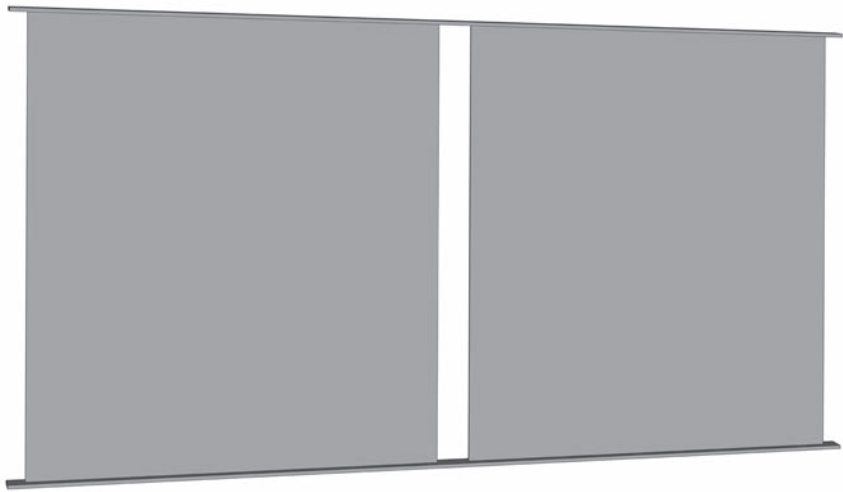

fencing applications  
applicazione per recinzioni

USE - UTILIZZO

ANCHORING - ANCORAGGIO



**arteferro**



## FINISHES AND COLORS FINITURE E COLORI

The two different available finishes can be customized with a powder coating, a coating process of metal surfaces with an organic film that not only provides the desired color but also protects them from corrosion and aggressive agents. In the case of structures to be used outdoors, before being painted, products can be subjected to a spray metallization treatment that guarantees resistance to weather conditions and corrosion for 10 years. Alternatively, the classic sandblasting and galvanizing process, both cold and hot, can be used before painting. In addition to standard colors, it is possible to request a particular chromaticity contained in the RAL color chart.

Le due diverse finiture disponibili possono essere personalizzate con una verniciatura a polvere, un procedimento di rivestimento delle superfici metalliche con un film organico che, oltre a dare loro il colore desiderato, le protegge dalla corrosione e dagli agenti aggressivi. In caso di manufatti da utilizzare all'esterno, prima di essere verniciati i prodotti possono essere sottoposti ad un trattamento di metallizzazione a spruzzo che garantisce per 10 anni la resistenza agli agenti atmosferici e alla corrosione. In alternativa è possibile ricorrere al classico procedimento di sabbiatura e zincatura, sia freddo che a caldo, prima della verniciatura. Oltre ai colori standard è possibile richiedere una particolare cromia contenuta nella mazzetta RAL.

The required products, before being painted, are first subjected to a spray-metallization treatment which guarantees a greater resistance to atmospheric agents over time.

I prodotti richiesti prima di essere verniciati vengono prima sottoposti ad un trattamento di metallizzazione a spruzzo che garantisce una maggiore resistenza agli agenti atmosferici nel tempo.



In addition to the colors shown here, the full RAL range is available  
Oltre ai colori qui riportati  
È disponibile tutta la gamma RAL  
[www.coloriral.it](http://www.coloriral.it)

### FINISHING FINITURE



**Raw**  
Grezzo

It is not an aesthetic finishing, the material is supplied **without** corrosion protection and **without** painting.

Non è una finitura estetica il materiale viene fornito **senza** protettivo alla corrosione e **senza** verniciatura.



**Metallisation arcspray process**  
Metallizzato

It is not an aesthetic finishing, the material is supplied **with** corrosion protection but **without** painting.

Non è una finitura estetica il materiale viene fornito **con** protettivo alla corrosione ma **non** verniciato.

### COLOURS COLORI

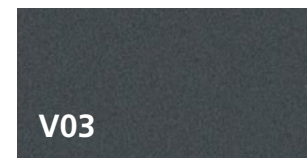

**V03**  
Anthracite  
Antracite

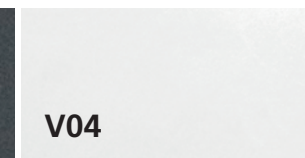

**V04**  
White  
Bianco

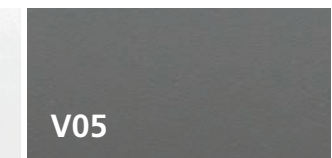

**V05**  
Grey  
Grigio

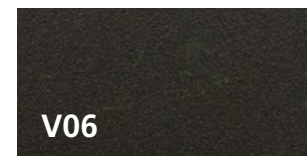

**V06**  
Ancient bronze  
Bronzo antico

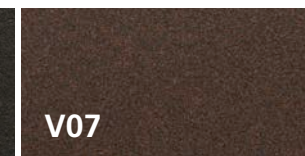

**V07**  
Cor-ten

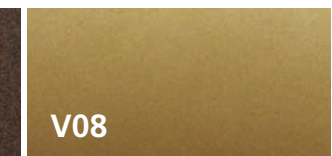

**V08**  
Gold  
Oro



# ACCESSORIES - ACCESSORI

<p>ANCHORAGE WITH CLAMP FOR BALCONY ANCORAGGIO SOLO PINZA PER BALCONI</p>  <p>2600000FB</p>	<p>KIT FOR WALL WITH EXTERNAL THERMAL INSULATION KIT PER MURATURE CON CAPPOTTO ESTERNO</p> <p>A: Spacers B: Dowel for external thermal insulation A: Distanziale B: Tassello per ancoraggio su cappotto termico esterno</p>  <p>GD304</p>	<p>ARTICULATED JOINT SNODO</p> <p>Adjustable Regolabile</p>  <p>Utilizzare solo con attacco laterale Use only with side attachment</p> <p>Stainless steel AISI 316 Acciaio inox AISI 316</p> <p>E0170316</p>	<p>ROUND BAR BARRA TONDA</p> <p>Ø 12 mm L 6000 mm</p>  <p>Utilizzare solo con attacco laterale Use only with side attachment</p> <p>Stainless steel AISI 316 Acciaio inox AISI 316</p> <p>E4851/6000</p>	
<p>HANDRAIL CORRIMANO</p> <p>60 x 20 x 2 mm L 6000 mm</p>  <p>Aluminium Alluminio</p> <p>E10006020</p>	<p>CORNER FOR WALL HANDRAIL FIXING ANGOLARE PER FISSAGGIO CORRIMANO A MURO</p>  <p>E08580</p>	<p>THREADED INSERTS FOR RIVETING TOOL INSERTI FILETTATI DA UTILIZZARE CON RIVETTATRICE</p>  <p>Stainless steel AISI 304 Acciaio inox AISI 304</p> <p>E40591 thread-filetto M5</p> <ol style="list-style-type: none"> <li>1 Mark drilling areas Segnare zone di foratura</li> <li>2 Insert E40591 using riveting tool Inserire E40591 utilizzando rivettatrice</li> <li>3 Fissare con ESM545 Fissare con ESM545</li> </ol> 	<p>SCREW M5X20 DIN 7991 AISI316 VITE M5X20 DIN 7991 AISI316</p> <p>M5 x 20 mm</p>  <p>Stainless steel AISI 316 Acciaio inox AISI 316</p> <p>ESM545</p>	
<p>END CAP TAPPO</p> <p>For tube - Per tubo 60 x 20 x 2 mm</p>  <p>Alluminium Alluminio</p> <p>E1100210</p>	<p>ANGULAR CONNECTOR CONNETTORE ANGOLARE</p> <p>For tube - Per tubo 60 x 20 x 2 mm</p>  <p>Alluminium Alluminio</p> <p>E1100230</p>	<p>LINEAR CONNECTOR CONNETTORE LINEARE</p> <p>For tube - Per tubo 60 x 20 x 2 mm</p>  <p>Alluminium Alluminio</p> <p>E1100220</p>	<p>SPRAY ZINC AND LIQUID ZINC ZINCO SPRAY E ZINCO LIQUIDO</p> <p>Spray and liquid zinc kit necessary in case of cutting or finishing of the material. Kit di zinco spray o liquido necessario in caso di taglio o rifinitura del materiale.</p>  <p>185/9</p> <p>185/9/B</p>	<p>PAINTING KIT KIT PER VERNICIATURE</p> <p>Arteferro supplies paints and patinas for finishing your wrought ironwork, both indoors and outdoors. Arteferro mette a disposizione vernici e patine per rifinire al meglio le vostre realizzazioni in ferro battuto, sia in interni che in esterni.</p>  <p>Paint code upon request Codice della vernice su richiesta</p>

## THE REGULATIONS LE NORMATIVE

To ensure maximum safety in their use, Arteferro System systems comply with the most stringent national and international regulations envisaged in relation to both their intended use and the installation environment. In some cases, they offer dimensional characteristics and mechanical performances superior to those required by regulations.

Per garantire la massima sicurezza nel loro utilizzo, i sistemi Arteferro System rispondono alle più stringenti normative nazionali ed internazionali previste in funzione sia della loro destinazione d'uso che dell'ambiente di installazione. In alcuni casi offrendo caratteristiche dimensionali e prestazioni meccaniche superiori a quanto richiesto dalle norme.

Values achievable with standard element  
 Valori raggiungibili con elementi standard

Values achievable with customized elements  
 Valori raggiungibili con elementi su misura

	Cat.	End use Destinazione d'uso	Example Esempio	EUROPEAN REGULATION NORMA EUROPEA (EUROCODE 1) OSK (kNm) EN 1991	ITALIAN REGULATION NORMA ITALIANA OSK (kNm) NTC 2018	Project value Valore di progetto (kNm)	Project calculation break value Valore rottura di calcolo di progetto x ks 1,5
DOMESTIC	A	Areas for domestic and residential activities Aree per attività domestiche e residenziali	Rooms in residential buildings and detached houses; rooms and aisles in hospitals, hotel rooms and hotel kitchens and bathrooms. Camere in edifici residenziali e abitazioni unifamiliari; camere e corsie negli ospedali camere negli alberghi e cucine e bagni negli ostelli	0,5	1	1	1,5
	B	Office areas Aree per uffici					
COMMERCIAL	C	Areas where people can meet (with the exception of A, B and D1 areas) Aree nelle quali le persone possono adunarsi (ad eccezione delle aree definite nelle categorie A,B e D1)	C1: Areas with tables, etc, such as in schools, cafés, restaurants, halls and libraries. C1: Aree con tavoli, ecc, per esempio, aree in scuole, caffè, ristoranti, sale per banchetti, sale di lettura, sale di ricevimento	0,5	1	1	1,5
			C2: Seating areas, such as in churches, theaters, cinemas, lecture halls and railway station lounges. C2: Aree con posti a sedere fissi, per esempio, aree nelle chiese, teatri o cinema, sale per conferenze, aule universitarie, aule magne, sale d'attesa ferroviarie	1	2	2	3
			C3: Areas without barriers to people movement, such as museums, exhibitions, admission areas in public places and administrative centers, hotels, hospitals and railway stations entrance halls. C3: Aree prive di ostacoli al movimento delle persone, per esempio, aree nei musei, sale d'esposizione, ecc. e aree di accesso negli edifici pubblici ed amministrativi, alberghi, ospedali, atri di stazioni ferroviarie	1	3	3	4,5
			C4: Areas liable to physical activities, such as dance halls, gyms and stages. C4: Aree con possibile svolgimento di attività fisiche, per esempio, sale da ballo, palestre, palcoscenici.	1	3	3	4,5
			C5: Crowded areas, for example buildings that host public events, such as concert halls, indoor stadium including grandstands, bleachers and access areas and railway platforms. C5: Aree suscettibili di grande affollamento, per esempio in edifici che ospitano eventi pubblici, come sale da concerto, palazzi degli sport, incluse le tribune, le gradinate e le aree d'accesso e le piattaforme ferroviarie.	3	3	3	4,5
	D	Business areas Aree per attività commerciali	D1: Areas in retail stores D2: Areas in shopping centers D1: Aree per acquisti generici al dettaglio D2: Aree in grandi magazzini	3	2	2	3
EXTRA	E	Warehouses Magazzini	E1: Areas liable to merchandise accumulation, admission and storing areas included. E2: Manufacturing use E1: Aree suscettibili all'accumulo di merci, incluse le aree d'accesso Aree per immagazzinamento inclusi immagazzinamento di libri e altri documenti. E2: Uso industriale	2	1	1	1,5

## LA NORMATIVA PREVEDE

THE RAILINGS MUST BE H 1000 MM.  
I PARAPETTI DEVONO ESSERE H 1000 MM.

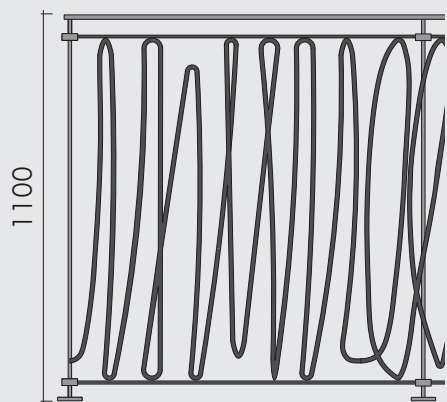

## I NOSTRI PARAPETTI

The Arteferro System railings are 1100 mm high and meet the standards UNI 10809:1999.

I nostri parapetti Arteferro System sono alti 1100 mm e rispondono alle normative UNI 10809:1999.

RAILINGS, BALUSTRADES OR FENCES MUST BE NON-TRAVERSABLE BY A 100 MM DIAMETRE SPHERE AT ANY POINT.

RINGHIERE, BALAUSTRATE O PARAPETTI DEVONO ESSERE INATTRAVERSABILI IN QUALSIASI PUNTO DA UNA SFERA DI 100 MM DI DIAMETRO.

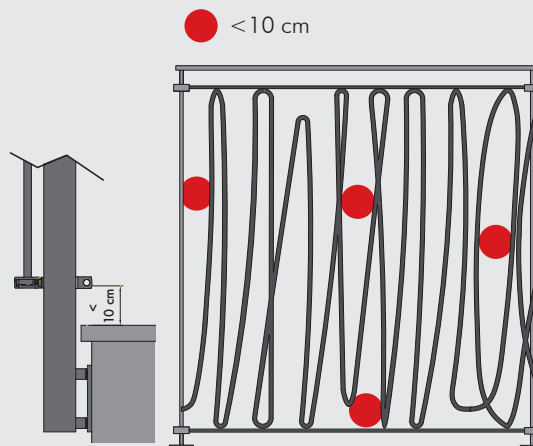

The protection elements of our Arteferro System railings have a distance from each other less than 10 cm.

Gli elementi di protezione dei nostri parapetti Arteferro System hanno un'apertura inferiore tra di loro di 10 cm.

OVER 500 MM OF FALLING, IT IS COMPULSORY NOT TO HAVE CLIMBABLE ELEMENTS.

AL DI SOPRA DI 500 MM DI CADUTA, È OBBLIGATORIO NON AVERE ELEMENTI SCALABILI.

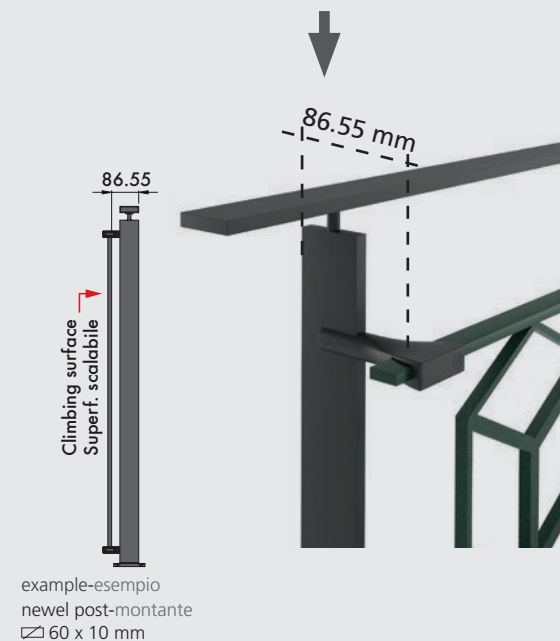

The handrail of the Arteferro System is positioned out of axis from the infill panel, so it meets the safety requirements regarding the railings anti-climbing.

Il corrimano installato nel Arteferro System si trova sempre disassato rispetto al pannello di tamponamento, risponde quindi ai requisiti di sicurezza in merito alla scalabilità dei parapetti.

## LABORATORY TESTS AND CERTIFICATIONS

### TEST DI LABORATORIO E CERTIFICAZIONI

All Arteferro systems are rigorously **tested and validated** in laboratories located within our facilities to ensure the **highest level of quality and safety**. To verify compliance with specific functional and performance requirements, we perform a set of tests, measurements, checks, and inspections before, during, and after production in the order prescribed by current regulations. The design and production quality of our products have also allowed us to obtain **numerous certifications** issued by third-party organizations, according to the regulations currently in force in many European countries. Below are some of the tests regularly carried out.

Tutti i sistemi Arteferro vengono rigorosamente **testati e collaudati**, nei laboratori situati all'interno dei nostri stabilimenti, per garantire il **massimo livello di qualità e sicurezza**. Per verificare la rispondenza agli specifici requisiti funzionali e prestazionali, effettuiamo un insieme di prove, misurazioni, accertamenti e ispezioni prima, durante e dopo la produzione nell'ordine previsto dalla normativa vigente. La qualità progettuale e produttiva dei nostri prodotti ci ha inoltre permesse di ottenere **numerose certificazioni**, rilasciate da Enti terzi, secondo le normative attualmente vigenti in molti paesi europei. Qui di seguito alcune delle prove che si effettuano regolarmente.



TEST VIDEO





#### Pre and post-failure static tests

The pre- and post-failure static tests are carried out following strict safety standards that define the criteria and static loads, both concentrated and distributed, of precast railings, balustrades, and parapets before and after failure.

#### Prove statiche pre e post rottura

Vengono eseguite seguendo rigidi standard di sicurezza che definiscono i criteri e i carichi statici, concentrati e distribuiti, pre e post rottura, di ringhiere, balaustre e parapetti prefabbricati.



#### Dynamic tests

Dynamic tests are carried out by impacting a moving object at a specific point of the guardrail system. The purpose is to verify the level of safety even in case of sudden impacts.

#### Prove dinamiche

Vengono eseguite facendo impattare un corpo in movimento in uno specifico punto del sistema parapetto. Il fine è quello di accertare il livello di sicurezza anche in caso di impatti improvvisi.



# *arteferro*



[arteferro.com](http://arteferro.com)

#### **GONZATO GROUP ITALY**

Ind.i.a. spa  
Via Vicenza, 6/14  
36034 - Malo  
Vicenza - Italia  
T. +39 0445 580 580  
F. +39 0445 580 874  
info@gonzato.com  
www.gonzato.com

#### **GONZATO GROUP USA-HOUSTON**

Indital US Ltd  
7947 Mesa Drive  
77028 - Houston  
Texas • U.S.A.  
T. +1 713 694 6065  
F. +1 713 694 2055  
forgings@indital.com  
www.gonzato.com

#### **GONZATO GROUP USA-MIAMI**

Arteferro Miami LLC  
2955 NW 75th Street  
33147 - Miami  
Florida • U.S.A.  
T. +1 305 836 9232  
F. +1 305 836 4113  
info@arteferromiami.com  
www.gonzato.com

#### **GONZATO GROUP USA-LOS ANGELES**

Gonzato Group CA, INC.  
3483 Chicago Avenue  
Riverside, CA 92507  
California • USA  
T. +1 951 465 7225  
info@gonzatogroup.us  
www.gonzato.com

#### **GONZATO GROUP FRANCE**

Ind.i.a. France Sarl  
P.A.E. la Baume, 7 Rue de l'Artisanat  
34290 - Servian  
Servian • France  
T. +33 (0) 4 67 39 42 81  
F. +33 (0) 4 67 39 20 90  
info.france@gonzato.com  
www.gonzato.com

#### **GONZATO GROUP SPAIN**

Ind.i.a. España, SL  
C/ Abedul, 43 – Polig. Ind. El Guíjar  
28500 - Arganda del Rey  
Madrid • España  
T. +34 918 700 819  
F. +34 918 700 820  
info@arteferro.es  
www.gonzato.com

#### **GONZATO GROUP CROATIA**

Arteferro Gorican d.o.o.  
Gospodarska ulica 1°  
40324 Goričan – Međimurje  
T. +385 (0) 40 602 222  
F. +385 (0) 40 602 230  
info@arteferro-dohomont.hr  
www.gonzato.com

#### **GONZATO GROUP ROMANIA**

S.C. Arteferro Braila S.A.  
Chiscani, Vizirului Street, Km 10  
Braila • Romania  
T.+ 40 004 0239 652 854  
arteferrocont@gmail.com  
www.gonzato.com

#### **GONZATO GROUP RUSSIA**

ООО "АРТЕФЕРРО-РУССИА"  
603124, Россия, Нижний Новгород,  
Вторчермета 1Г  
Тел. +7-831-2621999  
info@arteferroussia.com  
www.gonzato.com

#### **GONZATO GROUP MEXICO**

Arteferro Monterrey SA de CV  
Privada la Puerta 2879 B-4  
66350 - Col. Parque Industrial  
La Puerta Santa Catarina  
Nuevo Leon • México  
T. +52 1 81 1295 5094/95  
F. +52 1 81 1295 5097  
info@arteferromexico.com  
www.gonzato.com

#### **GONZATO GROUP ARGENTINA**

Arteferro Argentina SA  
Suárez 760,  
1162 Buenos Aires • Argentina  
T. +54 11 4301 2637  
F. +54 11 4301 2637  
info@arteferroargentina.com  
www.gonzato.com

#### **GONZATO GROUP CHILE**

Arteferro Chile SA  
Calle Los Arrayanes, 250, bodega 4  
9340000 -Santiago  
Colina • Chile  
T. +56 2 738 7419  
F. +56 2 738 7419  
arteferro@arteferrochile.cl  
www.gonzato.com

#### **GONZATO GROUP CHINA**

Gonzato (Qingdao) Decoration Co., Ltd  
Office 108/109  
No. 10 South Building  
No. 130 Tianlin Road  
Xuhui District, Shanghai  
T. +86 13708959259

#### **GONZATO GROUP BRAZIL**

Ind.i.a. Brasil LTDA  
Rua Padre Feijó, 480  
95190-000 - São Marcos  
Rio Grande do Sul • Brasil  
T. +55 54 3291 1416  
F. +55 54 3291 1416  
Branch  
Av. Almirante Cochrane, 194 – Sala 32  
11040-200 – Santos - Sao Paulo • Brasil  
T. +55 13 21389091  
vendas@arteferrobrasil.com.br  
www.gonzato.com

# arteferro

Arteferro is a brand of Gonzato Group  
Via Vicenza, 6/14 (SP46) – 36034 Malo (Vicenza) Italy  
Tel. +39 0445 580 580 • Fax +39 0445 580 874  
info@arteferro.com • arteferro.com

